

AMH

Automotive bolt in fuse



Product features

- Small size for high current applications
- 125 Vdc voltage rating
- Ceramic body with bolt in terminal design
- UL recognized

Applications

- High current wire protection
- Vehicle power distribution
- Material handling systems
- Aircraft power distribution
- All supercapacitor and battery systems
- High current wire protection

Agency information

- cURus recognized file: E91958, guide JFHR2 and JFHR8



Environmental compliance



Ordering part number

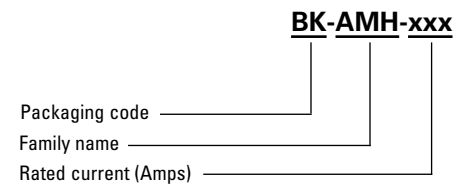

Packaging code

- BK - 30 parts per tray
- Blank - 1 part per polybag, 10 parts per inner box

Electrical characteristics

Amp rating	1.0 In	3.0 In
350 - 500	4 hours minimum	< 10 seconds

Product specifications

Part number	Rated current (A)	Voltage rating (Vdc)	Breaking capacity ¹	Typical cold resistance (mOhms) ²
AMH-350	350	125	16 kA @ 125 Vdc 20 KA @ 125 Vdc*	0.14
AMH-400	400	125	16 kA @ 125 Vdc 20 KA @ 125 Vdc*	0.125
AMH-500	500	125	16 kA @ 125 Vdc 20 KA @ 125 Vdc*	0.104

1. Self-certified for 20 kA @ 125 Vdc, TC < 2 ms
2. Cold resistance is measured at <10% rated current

Dimensions- mm

Drawing not to scale

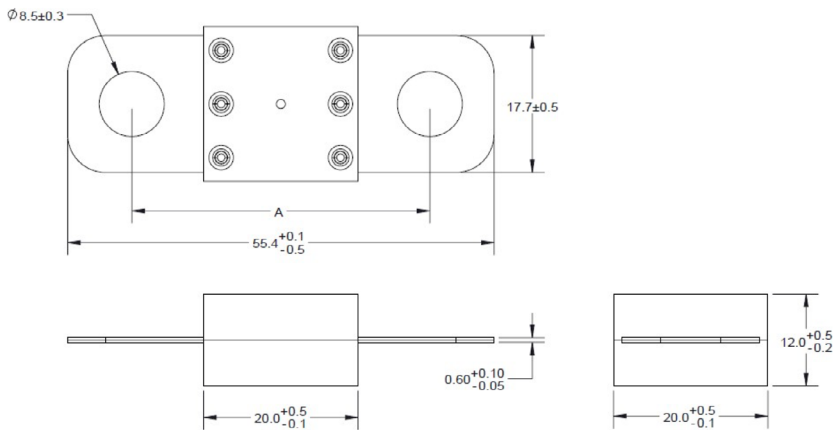

Part number	Dimension A (mm)
AMH-XXX	39 +/- 0.3

Recommended torque: M8: 12+/-1 N-m.

Marking detail

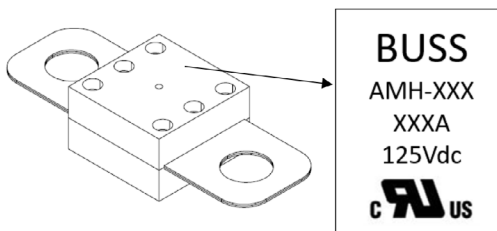

Part number	Marking on body
AMH-350	BUSS AMH-350 350 A 125 Vdc cURus
AMH-400	BUSS AMH-400 400 A 125 Vdc cURus
AMH-500	BUSS AMH-500 500 A 125 Vdc cURus

General specifications

Item	Standrd/Specification	Conditions	Acceptable value/range
Operating temperature		-40 °C to +105 °C with proper derating	
Strength of terminals	JASO D622 ISO8820-8	mounting torque 12+/-1 Nm, 3 times	Resistance change <10%
Temperature rise	JASO D622 ISO8820-8	0.5 In, 40 min	not exceed 50 K
Temperature humidity cycling	JASO D622 ISO8820-8	a) maintain the samples at standard conditions for 4 h; b) increase T to 55+/-2 °C at 95% to 99% RH within 0.5 h; c) maintain T at 55+/-2 °C at 95% to 99% RH for 10 h; d) decrease T to -40+/-2 °C within 2.5 h; the humidity is uncontrolled; e) maintain T at -40+/-2 °C for 2 h; the humidity is uncontrolled; f) increase T to 120+/-2 °C within 1.5 h from -40+/-2 °C; the humidity is uncontrolled; g) maintain T at 120+/-2 °C for 2 h; the humidity is uncontrolled; h) allow to return to RT within 1.5 h; the humidity is uncontrolled; 10 cycles.	Resistance change <10%, electrical performance within spec
Thermal shock	JASO D622 ISO8820-8 (reference)	a) -40+/-2 °C, 20 min; b) 15 sec dwell time; c) 125+/-2 °C, 20 min; d) 15 sec dwell time; 48 cycles.	Resistance change <10%, electrical performance within spec
Vibration	UL248-20 IEC 60068-2-64	Random vibration. Condition C: rms 30.2 m/s ² , 3 directions, 8 hrs each.	Resistance change <10%, electrical performance within spec
Transient current cycling	JASO D622 ISO8820-8 (reference)	23+/-5 °C, each cycle current 2 In/0.25 sec, 0.5 In/5 sec, 50000 cycles.	Resistance change <10%, electrical performance within spec
Lubricant & fuel oil resistance	GB/T31465.1-5.4	Wipe the marking with lubricant or oil 30 s	Marking can be identified
Breaking capacity		Follow the spec	IR > 0.1 Mohm, no explosion

Temperature derating curve

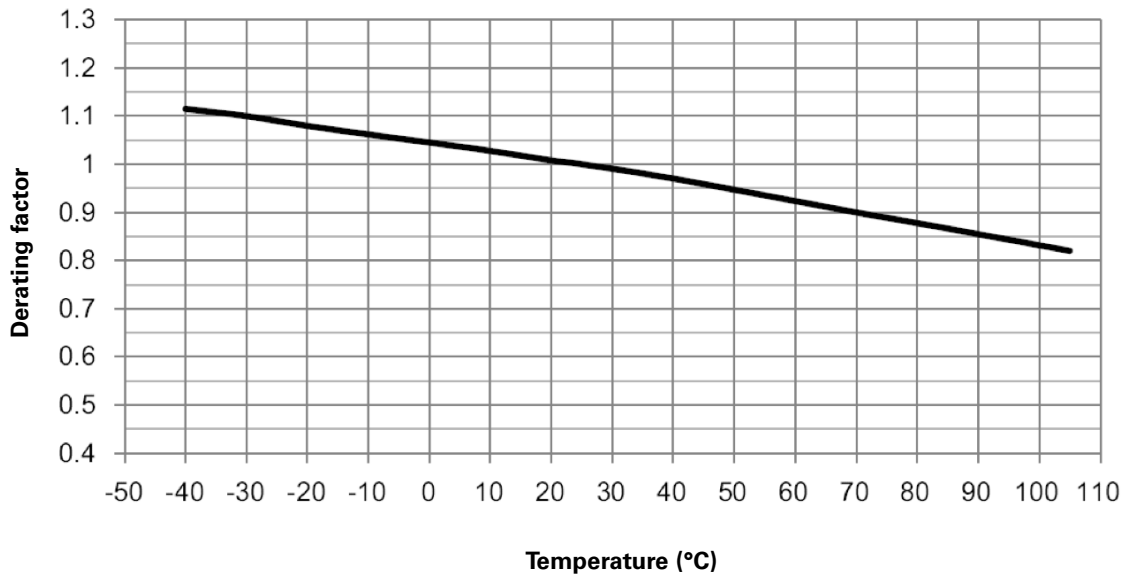

Current vs. time curve

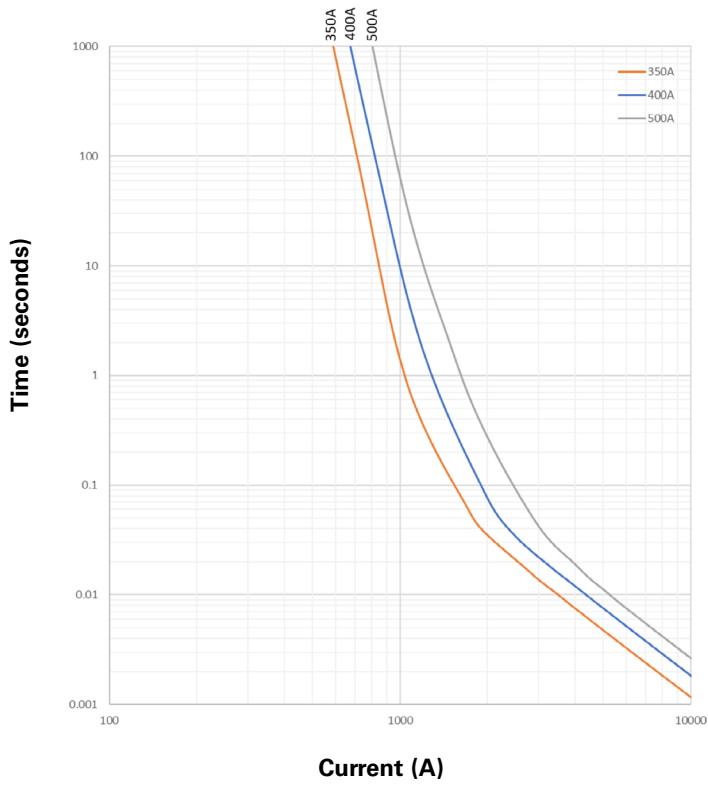

I²t vs. time curve

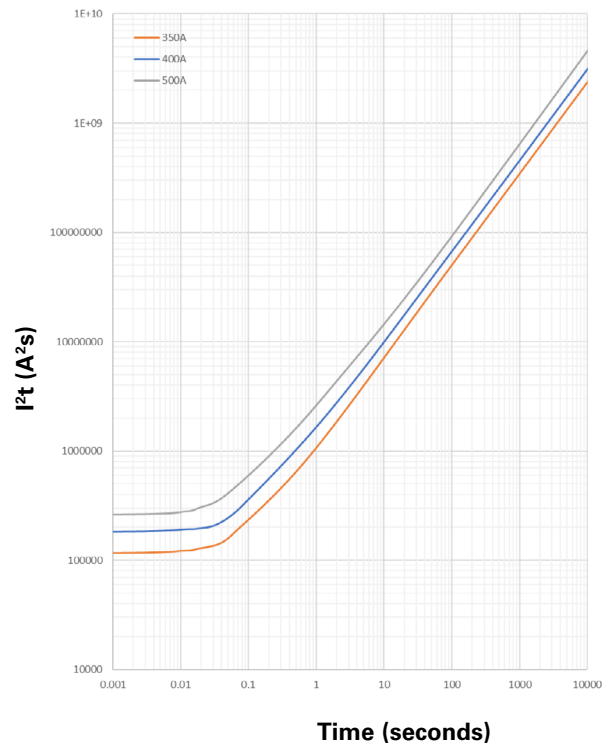

I²t vs. current curve

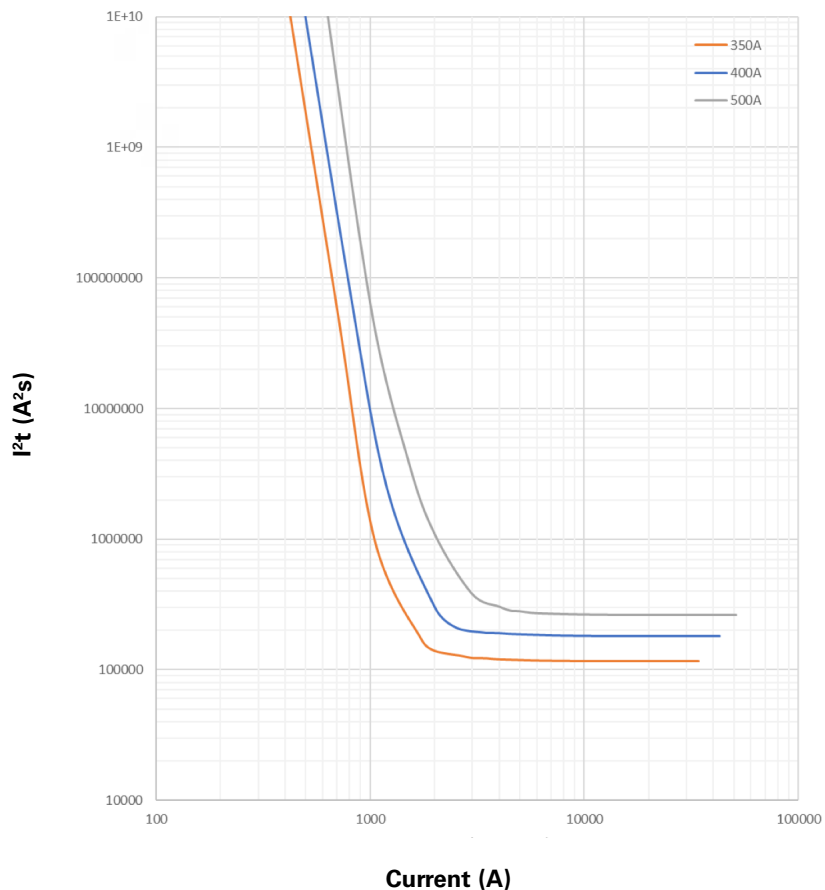

Life Support Policy: Eaton does not authorize the use of any of its products for use in life support devices or systems without the express written approval of an officer of the Company. Life support systems are devices which support or sustain life, and whose failure to perform, when properly used in accordance with instructions for use provided in the labeling, can be reasonably expected to result in significant injury to the user.

Eaton reserves the right, without notice, to change design or construction of any products and to discontinue or limit distribution of any products. Eaton also reserves the right to change or update, without notice, any technical information contained in this bulletin.

Eaton
Electronics Division
1000 Eaton Boulevard
Cleveland, OH 44122
United States
Eaton.com/electronics

© 2022 Eaton
All Rights Reserved
Printed in USA
Publication No. ELX1217 BU-ELX22077
August 2022

Eaton is a registered trademark.

All other trademarks are property of their respective owners.

Follow us on social media to get the latest product and support information.

