

## Summary

The AMD Alveo U55C data center accelerator card, shown in the following figure, is a single slot, full height, half length form factor passively-cooled card. It supports PCI Express® (PCIe®) Gen3 x16 or dual Gen4 x8, and is equipped with 16 GB of high-bandwidth memory (HBM2) and dual QSFP28 Ethernet ports capable of 100 Gb/s each. The Alveo U55C is designed to accelerate memory-bound, compute intensive applications in high-performance computing, AI inference, and database and data analytics.

Figure 1: Alveo U55C Data Center Accelerator Card



Card applications can be created using the Vitis™ unified software platform which uses high-level languages such as C, C++, and OpenCL™. For experienced programmable logic developers, the card can be developed with the Vivado™ Design Suite where the full resources of the programmable logic device are made available for development.

AMD Adaptive Computing is creating an environment where employees, customers, and partners feel welcome and included. To that end, we're removing non-inclusive language from our products and related collateral. We've launched an internal initiative to remove language that could exclude people or reinforce historical biases, including terms embedded in our software and IPs. You may still find examples of non-inclusive language in our older products as we work to make these changes and align with evolving industry standards. Follow this [link](#) for more information.

# Product Details

Table 1: Alveo U55C Accelerator Card Product Details

Specification	U55C
Product SKU	A-U55C-P00G-PQ-G
Total electrical card load <sup>1</sup>	150W
Thermal design power (TDP) <sup>2</sup>	115W
Thermal cooling solution	Passive
Weight	519g
Form factor	Full height, half length
Network interface	2 x QSFP28
PCIe interface <sup>3</sup>	Gen3 x16, 2 x Gen4 x8
HBM2 total capacity	16 GB
HBM2 bandwidth	460 GB/s
Look-up tables (LUTs)	1,304K
Registers	2,607K
DSP slices	9,024
Maximum distributed RAM	36.7 Mb
36 Kb block RAM	70.9 Mb
288 Kb UltraRAM	960 (270 Mb)
GTY transceivers	24
Qualified for deployment	Yes

**Notes:**

1. The Alveo U55C card supports multiple power solutions, and the electrical power capabilities can exceed the thermal capabilities. See [AUX Power Connector](#) for maximum power available.
2. TDP is dependent on server airflow capability. See [Operating Conditions](#) for airflow requirements.
3. This block operates in compatibility mode for 16.0 GT/s (Gen4) operation. Refer to *UltraScale+ Devices Integrated Block for PCI Express LogiCORE IP Product Guide (PG213)* for details on compatibility mode.

# Card Specifications

## Block Diagram

The following figure shows the components within an Alveo U55C accelerator card.

Figure 2: XCU55C Block Diagram

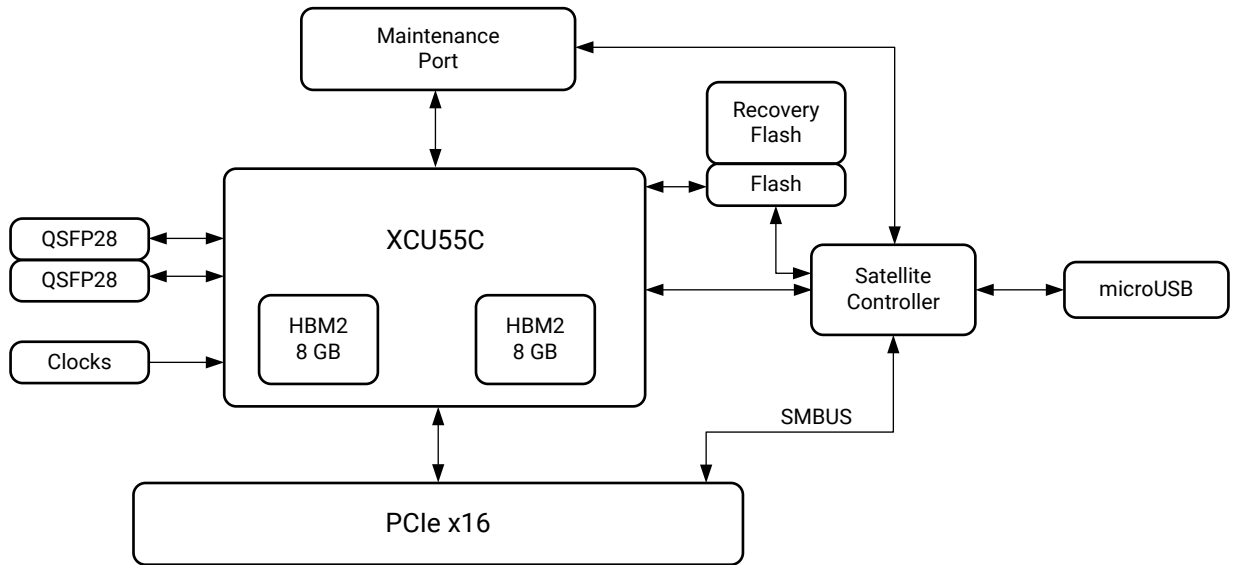

X24096-111121

## PCIe Connector/Data Rates

The Alveo U55C accelerator card uses an UltraScale+™ FPGA containing a PCIE4C block. The PCIE4C block is compliant to the PCI Express Base Specification v3.1 supporting up to 8.0 GT/s (Gen3 x16) and compatible with PCI Express Base Specification v4.0 supporting up to 16.0 GT/s (Gen4 x8). The PCIE4C block is also compliant with CCIX Base Specification Revision 1.0 v0.9, supporting speeds up to 16.0 GT/s. The PCI Express interface can also be configured into dual x8 interfaces and connected to hosts that support PCI Express bifurcation.

Table 2: PCI Express Data Transfer Rate Performance

PCI Express Generation	Performance
Gen 1	2.5 GigaTransfers per second (GT/s)
Gen 2	5.0 GT/s
Gen 3	8.0 GT/s
Gen 4 <sup>1</sup>	16.0 GT/s

**Notes:**

- For a list of limitations when operating at the Gen4 rate, see *UltraScale+ Devices Integrated Block for PCI Express LogiCORE IP Product Guide (PG213)*.

## Network Interfaces

The Alveo U55C card comes with a dual 4-lane QSFP28 that can accept modules up to 3.5W. The QSFP28 can connect interfaces up to 100G using optical modules or cables. A 161.1328125 MHz clock is provided to the QSFP28 interface such that different Ethernet IP cores can be enabled. The Alveo U55C card is shipped with eight unique MAC IDs. These IDs are located on a sticker on the back of the unit and can be retrieved through the card management solution IP. See the *Card Management Solution Subsystem Product Guide* (PG348) for more information.

Each connector is housed within a single QSFP cage assembly, located on the I/O bracket. The QSFP port number and location are shown in the following figure.

Figure 3: QSFP Port Location

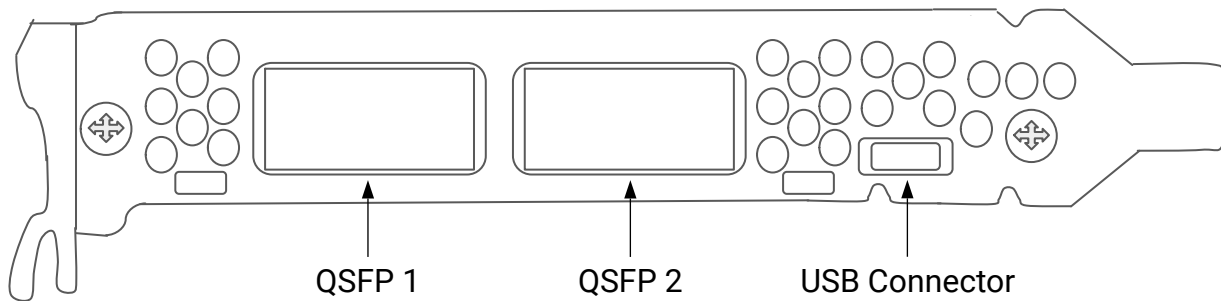

X26906-011623

The following table provides the mapping of the I/O bracket QSFP port name to the QSFP FPGA GT Quad. In addition, for those using the Vitis™ flow, it provides the GT index allocated in the Vitis software platform.

Table 3: QSFP Port to Quad and Index Mapping

QSFP Port	QSFP FPGA GT Quad	QSFP GT Index (Vitis Platform)
QSFP 1	QUAD_X0Y6	GTS0
QSFP 2	QUAD_X0Y7	GTS1

## Satellite Controller

A TI MSP432 satellite controller resides on the U55C card to control and monitor voltages, currents and temperatures. The host server board management controller (BMC) can interact with the satellite controller to monitor and control U55C cards through out-of-band communication. AMD supports the PLDM protocol over MCTP over SMBUS, complying with DMTF standards. Refer to the *Alveo Card Out-of-Band Management Specification for Server BMC* (XD038) for more information. When used with the AMD provided platform, you can easily monitor for any abnormal operating conditions and react accordingly. If you are not using the platform, AMD provides a Card Management Solution IP allowing you to quickly develop and interact with the satellite controller from the FPGA. See the *Card Management Solution Subsystem Product Guide* (PG348) for more information.

## Maintenance Port

The maintenance port allows access to a number of different features and signals including JTAG, UARTs, PMBus, and resets. Connecting the Alveo programming cable to the maintenance port allows access to these features. See the *Alveo Programming Cable User Guide* ([UG1377](#)) for more information.

## USB Maintenance Port

The Alveo U55C accelerator card includes a micro-USB maintenance port located at the back of the card.

## FPGA Resource Information

The AMD Alveo U55C accelerator card includes a custom-built UltraScale+ FPGA that runs optimally (and exclusively) on Alveo architecture. The Alveo U55C card features the XCU55C FPGA, which uses AMD stacked silicon interconnect (SSI) technology to deliver breakthrough FPGA capacity, bandwidth, and power efficiency. This technology allows for increased density by combining multiple super logic regions (SLRs).

The following figure shows the three SLR regions of the XCU55C along with the connections for PCIe and QSFP. The HBM2 is co-located on the XCU55C device and connects directly to SLR0.

*Figure 4: Floorplan of the XCU55C Device with Dual QSFP Connection*

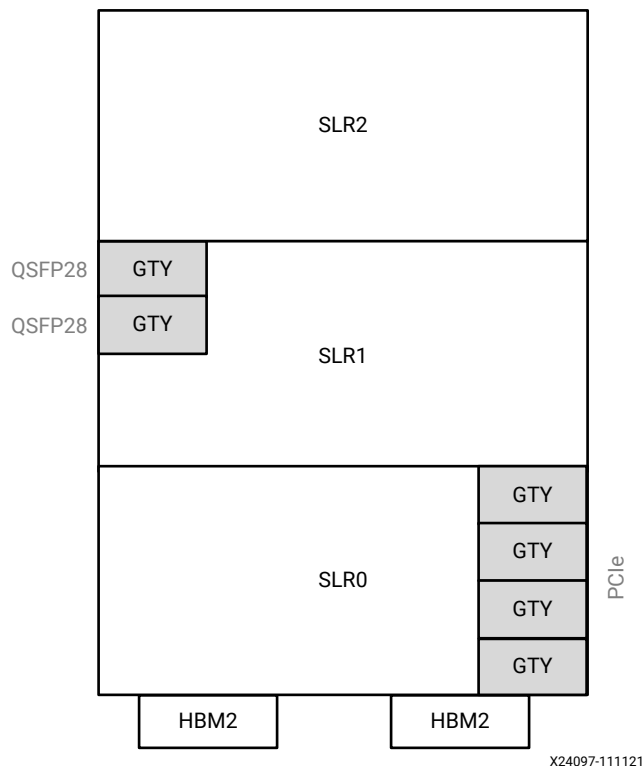

## Qualified Servers

A list of servers on which Alveo cards are fully qualified can be found here: <https://www.xilinx.com/products/boards-and-kits/alveo/qualified-servers.html>.

## Operating System Compatibility

For the most up-to-date operating system support, refer to the *Vitis Unified Software Platform Documentation: Application Acceleration Development* ([UG1393](#)).

## AUX Power Connector

The Alveo U55C accelerator card includes an 8-pin PCIe AUX power connector that provides additional power configurations. All configurations use, at minimum, the 75W PCIe slot power. Connecting a 6-pin or 8-pin PCIe AUX power cable provides additional power. The maximum power available for the various AUX power cable configurations is given in the following table.

**Note:** A PCI Express auxiliary power connector is not compatible with an ATX12V/EPS12V power cable source.

*Table 4: Power Availability*

AUX Power Configuration	Maximum Power Available
No AUX power cable connected	75W
2x3 AUX power cable connected	150W
2x4 AUX power cable connected	225W <sup>1</sup>

**Notes:**

- While this configuration supplies 225W, the U55C card consumes at most 150W.
- The Alveo U55C card supports multiple power solutions, and the electrical power capabilities can exceed the thermal capabilities. See [Table 1](#) for card thermal design power.

## Mechanical

The U55C card is compliant with the PCIe CEM rev.3.0 specification as single slot, full height, half length cards.

*Table 5: Card Dimensions*

Parameter	Dimension
Height	4.375 inch (111.15 mm)
PCB thickness ( $\pm 0.13$ mm (0.005 inch))	0.62 inch (1.57 mm)
Primary side width	0.570 inch (14.47 mm)
Secondary side width	0.105 inch (2.67 mm)
Length	6.60 inch (167.65 mm)

## Thermal

### Operating and Storage Temperature Conditions

*Table 6: Operating and Storage Temperatures and Humidity Conditions*

Specification	Condition
Operating temperature	0°C to 55°C

**Table 6: Operating and Storage Temperatures and Humidity Conditions (cont'd)**

Specification	Condition
Storage temperature	-40°C to 75°C
Operating humidity, non-condensing	8% to 90%, and a dew point of -12°C
Storage humidity, non-condensing	5% to 95%

## Board and Temperature Limits

**Table 7: Board and Temperature Limits**

Sensor Name	Warning Limit (°C)	Critical Limit (°C)	Fatal Limit (°C)
Logical FPGA Temperature	88	97	107
Board Temperature	100	110	125

## Airflow Direction Support

The following figure illustrates the recommended normal airflow in the U55C card.

**Figure 5: Recommended Normal Airflow Direction for U55C Card**

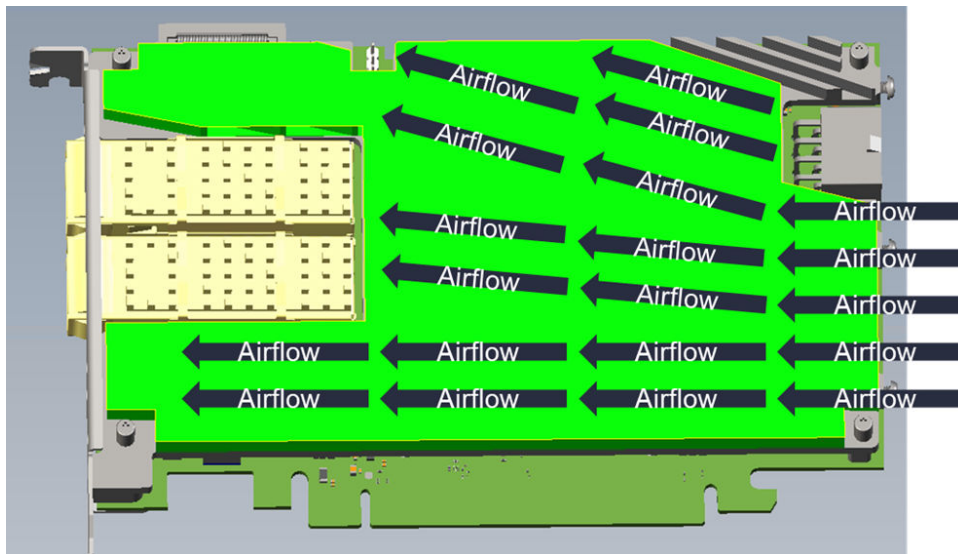

X24095-060820

**Note:** Other environmental conditions are possible, including bidirectional flow. However, this is specific to server configurations, and testing is performed by individual OEMs. Contact your server provider for more information and options.

## Operating Conditions

## Inlet Temperature versus Airflow Requirement in Server

The following tables provide the required airflow rate and airflow speed to the Alveo U55C card under various operating conditions.

### Normal Airflow

**Table 8: Inlet Temperature versus Airflow Requirement of PCIe Card Slot (98.4 mm x 20.33 mm) at Sea Level for 115W Total Card Power**

Inlet Temperature to the Card (°C)	With QSFP (85°C)			Without QSFP <sup>1</sup>		
	Cubic Feet per Minute (CFM)	Linear Feet per Minute (LFM)	Static Pressure (inwg)	Cubic Feet per Minute (CFM)	Linear Feet per Minute (LFM)	Static Pressure (inwg)
25	11.0	512	0.37	11.3	525	0.36
30	12.3	571	0.43	12.8	596	0.44
35	13.8	642	0.52	14.7	684	0.55
40	15.8	732	0.64	17.1	796	0.70
45	18.2	844	0.80	20.2	940	0.93
50	21.3	991	1.03	24.4	1133	1.28
55	25.6	1189	1.40	30.1	1399	1.85

**Notes:**

1. The card without QSFP allocates more power in the FPGA which is consumed in the *card with QSFP* scenario.

**Table 9: Inlet Temperature versus Airflow Requirement of PCIe Card Slot (98.4 mm x 20.33 mm) at 1200m above Sea Level for 115W Total Card Power**

Inlet Temperature to the Card (°C)	With QSFP (85°C)			Without QSFP <sup>1</sup>		
	Cubic Feet per Minute (CFM)	Linear Feet per Minute (LFM)	Static Pressure (inwg)	Cubic Feet per Minute (CFM)	Linear Feet per Minute (LFM)	Static Pressure (inwg)
25	11.7	545	0.40	12.0	559	0.40
30	13.1	608	0.48	13.7	635	0.49
35	14.7	684	0.57	15.7	729	0.61
40	16.8	779	0.70	18.2	847	0.78
45	19.4	899	0.88	21.6	1001	1.03
50	22.7	1056	1.15	26.0	1206	1.43
55	27.3	1266	1.56	32.1	1490	2.07

**Notes:**

1. The card without QSFP allocates more power in the FPGA which is consumed in the *card with QSFP* scenario.

**Table 10: Inlet Temperature versus Airflow Requirement of PCIe Card Slot (98.4 mm x 20.33 mm) at Sea Level for 135W Total Card Power**

Inlet Temperature to the Card (°C)	With QSFP (85°C)			Without QSFP <sup>1</sup>		
	Cubic Feet per Minute (CFM)	Linear Feet per Minute (LFM)	Static Pressure (inwg)	Cubic Feet per Minute (CFM)	Linear Feet per Minute (LFM)	Static Pressure (inwg)
25	13.7	637	0.51	14.2	658	0.52



**Table 10: Inlet Temperature versus Airflow Requirement of PCIe Card Slot (98.4 mm x 20.33 mm) at Sea Level for 135W Total Card Power (cont'd)**

Inlet Temperature to the Card (°C)	With QSFP (85°C)			Without QSFP <sup>1</sup>		
	Cubic Feet per Minute (CFM)	Linear Feet per Minute (LFM)	Static Pressure (inwg)	Cubic Feet per Minute (CFM)	Linear Feet per Minute (LFM)	Static Pressure (inwg)
30	15.3	710	0.61	16.1	747	0.63
35	17.2	799	0.73	18.5	858	0.80
40	19.6	910	0.90	21.5	997	1.03
45	22.6	1051	1.14	25.4	1178	1.37
50	26.6	1233	1.49	30.6	1419	1.90
55	31.9	1480	2.03	37.8	1753	2.77

**Notes:**

1. The card without QSFP allocates more power in the FPGA which is consumed in the *card with QSFP* scenario.

**Table 11: Inlet Temperature versus Airflow Requirement of PCIe Card Slot (98.4 mm x 20.33 mm) at 1200m above Sea Level for 135W Total Card Power**

Inlet Temperature to the Card (°C)	With QSFP (85°C)			Without QSFP <sup>1</sup>		
	Cubic Feet per Minute (CFM)	Linear Feet per Minute (LFM)	Static Pressure (inwg)	Cubic Feet per Minute (CFM)	Linear Feet per Minute (LFM)	Static Pressure (inwg)
25	14.6	678	0.56	15.1	701	0.57
30	16.3	756	0.67	17.1	796	0.70
35	18.3	851	0.81	19.7	913	0.89
40	20.9	969	1.00	22.9	1062	1.14
45	24.1	1119	1.26	27.0	1254	1.53
50	28.3	1314	1.66	32.5	1512	2.12
55	33.9	1576	2.26	40.2	1867	3.10

**Notes:**

1. The card without QSFP allocates more power in the FPGA which is consumed in the *card with QSFP* scenario.

**Table 12: Inlet Temperature versus Airflow Requirement of PCIe Card Slot (98.4 mm x 20.33 mm) at Sea Level for 150W Total Card Power**

Inlet Temperature to the Card (°C)	With QSFP (85°C)			Without QSFP <sup>1</sup>		
	Cubic Feet per Minute (CFM)	Linear Feet per Minute (LFM)	Static Pressure (inwg)	Cubic Feet per Minute (CFM)	Linear Feet per Minute (LFM)	Static Pressure (inwg)
25	15.8	735	0.64	16.4	763	0.66
30	17.6	820	0.76	18.7	867	0.81
35	19.9	923	0.92	21.4	994	1.02
40	22.6	1051	1.14	24.9	1156	1.32
45	26.1	1213	1.45	29.4	1366	1.77
50	30.7	1424	1.90	35.4	1646	2.47

**Table 12: Inlet Temperature versus Airflow Requirement of PCIe Card Slot (98.4 mm x 20.33 mm) at Sea Level for 150W Total Card Power (cont'd)**

Inlet Temperature to the Card (°C)	With QSFP (85°C)			Without QSFP <sup>1</sup>		
	Cubic Feet per Minute (CFM)	Linear Feet per Minute (LFM)	Static Pressure (inwg)	Cubic Feet per Minute (CFM)	Linear Feet per Minute (LFM)	Static Pressure (inwg)
55	36.8	1708	2.60	43.8	2033	3.62

**Notes:**

1. The card without QSFP allocates more power in the FPGA which is consumed in the *card with QSFP* scenario.

**Table 13: Inlet Temperature versus Airflow Requirement of PCIe Card Slot (98.4 mm x 20.33 mm) at 1200m above Sea Level for 150W Total Card Power**

Inlet Temperature to the Card (°C)	With QSFP (85°C)			Without QSFP <sup>1</sup>		
	Cubic Feet per Minute (CFM)	Linear Feet per Minute (LFM)	Static Pressure (inwg)	Cubic Feet per Minute (CFM)	Linear Feet per Minute (LFM)	Static Pressure (inwg)
25	16.8	782	0.71	17.5	813	0.73
30	18.8	873	0.84	19.9	923	0.90
35	21.2	982	1.02	22.8	1059	1.14
40	24.1	1119	1.26	26.5	1231	1.48
45	27.8	1292	1.61	31.3	1455	1.98
50	32.7	1516	2.12	37.7	1753	2.77
55	39.2	1819	2.91	46.6	2166	4.07

**Notes:**

1. The card without QSFP allocates more power in the FPGA which is consumed in the *card with QSFP* scenario.

## Reverse Airflow

**Table 14: Inlet Temperature versus Airflow Requirement of PCIe Card Slot (104.57 mm x 13.18 mm) at Sea Level for 115W Total Card Power**

Inlet Temperature to the Card (°C)	With QSFP (85°C)			Without QSFP <sup>1</sup>		
	Cubic Feet per Minute (CFM)	Linear Feet per Minute (LFM)	Static Pressure (inwg)	Cubic Feet per Minute (CFM)	Linear Feet per Minute (LFM)	Static Pressure (inwg)
25	14.0	944	1.59	14.8	999	1.09
30	15.9	1071	2.00	16.9	1138	1.37
35	18.2	1229	2.57	19.5	1312	1.77
40						
45						
50						
55						

**Notes:**

1. The card without QSFP allocates more power in the FPGA which is consumed in the *card with QSFP* scenario.
2. In reverse flow, the card only supports an ambient temperature of  $\leq 35^{\circ}\text{C}$ .

**Table 15: Inlet Temperature versus Airflow Requirement of PCIe Card Slot (104.57 mm x 13.18 mm) at 1200m above Sea Level for 115W Total Card Power**

Inlet Temperature to the Card (°C)	With QSFP (85°C)			Without QSFP <sup>1</sup>		
	Cubic Feet per Minute (CFM)	Linear Feet per Minute (LFM)	Static Pressure (inwg)	Cubic Feet per Minute (CFM)	Linear Feet per Minute (LFM)	Static Pressure (inwg)
25	14.9	1005	1.78	15.8	1064	1.22
30	16.9	1141	2.24	18.0	1212	1.54
35	19.4	1309	2.88	20.7	1397	1.99
40						
45						
50						
55						

**Notes:**

1. The card without QSFP allocates more power in the FPGA which is consumed in the *card with QSFP* scenario.
2. In reverse flow, the card only supports an ambient temperature of  $\leq 35^{\circ}\text{C}$ .

**Table 16: Inlet Temperature versus Airflow Requirement of PCIe Card Slot (104.57 mm x 13.18 mm) at Sea Level for 135W Total Card Power**

Inlet Temperature to the Card (°C)	With QSFP (85°C)			Without QSFP <sup>1</sup>		
	Cubic Feet per Minute (CFM)	Linear Feet per Minute (LFM)	Static Pressure (inwg)	Cubic Feet per Minute (CFM)	Linear Feet per Minute (LFM)	Static Pressure (inwg)
25	18.0	1216	2.52	18.8	1270	1.67
30	20.5	1380	3.18	21.5	1448	2.12
35	23.5	1583	4.10	24.8	1668	2.76
40						
45						
50						
55						

**Notes:**

1. The card without QSFP allocates more power in the FPGA which is consumed in the *card with QSFP* scenario.
2. In reverse flow, the card only supports an ambient temperature of  $\leq 35^{\circ}\text{C}$ .

**Table 17: Inlet Temperature versus Airflow Requirement of PCIe Card Slot (104.57 mm x 13.18 mm) at 1200m above Sea Level for 135W Total Card Power**

Inlet Temperature to the Card (°C)	With QSFP (85°C)			Without QSFP <sup>1</sup>		
	Cubic Feet per Minute (CFM)	Linear Feet per Minute (LFM)	Static Pressure (inwg)	Cubic Feet per Minute (CFM)	Linear Feet per Minute (LFM)	Static Pressure (inwg)
25	19.2	1295	2.83	20.1	1353	1.88
30	21.8	1470	3.57	22.9	1542	2.38
35	25.0	1687	4.62	26.4	1777	3.10
40						
45						
50						

**Table 17: Inlet Temperature versus Airflow Requirement of PCIe Card Slot (104.57 mm x 13.18 mm) at 1200m above Sea Level for 135W Total Card Power (cont'd)**

Inlet Temperature to the Card (°C)	With QSFP (85°C)			Without QSFP <sup>1</sup>		
	Cubic Feet per Minute (CFM)	Linear Feet per Minute (LFM)	Static Pressure (inwg)	Cubic Feet per Minute (CFM)	Linear Feet per Minute (LFM)	Static Pressure (inwg)
55						

**Notes:**

1. The card without QSFP allocates more power in the FPGA which is consumed in the *card with QSFP* scenario.
2. In reverse flow, the card only supports an ambient temperature of  $\leq 35^{\circ}\text{C}$ .

**Table 18: Inlet Temperature versus Airflow Requirement of PCIe Card Slot (104.57 mm x 13.18 mm) at Sea Level for 150W Total Card Power**

Inlet Temperature to the Card (°C)	With QSFP (85°C)			Without QSFP <sup>1</sup>		
	Cubic Feet per Minute (CFM)	Linear Feet per Minute (LFM)	Static Pressure (inwg)	Cubic Feet per Minute (CFM)	Linear Feet per Minute (LFM)	Static Pressure (inwg)
25	21.3	1436	3.42	22.1	1488	2.23
30	24.2	1630	4.33	25.2	1696	2.84
35	27.7	1870	5.61	29.0	1954	3.70
40						
45						
50						
55						

**Notes:**

1. The card without QSFP allocates more power in the FPGA which is consumed in the *card with QSFP* scenario.
2. In reverse flow, the card only supports an ambient temperature of  $\leq 35^{\circ}\text{C}$ .

**Table 19: Inlet Temperature versus Airflow Requirement of PCIe Card Slot (104.57 mm x 13.18 mm) at 1200m above Sea Level for 150W Total Card Power**

Inlet Temperature to the Card (°C)	With QSFP (85°C)			Without QSFP <sup>1</sup>		
	Cubic Feet per Minute (CFM)	Linear Feet per Minute (LFM)	Static Pressure (inwg)	Cubic Feet per Minute (CFM)	Linear Feet per Minute (LFM)	Static Pressure (inwg)
25	22.7	1530	3.85	23.5	1585	2.51
30	25.8	1736	4.88	26.8	1806	3.19
35	29.6	1992	6.32	30.9	2082	4.16
40						
45						
50						
55						

**Notes:**

1. The card without QSFP allocates more power in the FPGA which is consumed in the *card with QSFP* scenario.
2. In reverse flow, the card only supports an ambient temperature of  $\leq 35^{\circ}\text{C}$ .

# Regulatory Compliance Statements

## FCC Class A Products

**Note:** These devices are for use with UL Listed Servers or I.T.E.

### Safety Compliance

The following safety standards apply to all products listed above.

- EU LVD Directive 2014/35/EU
- Electrical Equipment (Safety) Regulations 2016 (UK)
- EN/IEC-62368-1:2018

### EMC Compliance

The following standards apply.

#### Class A Products

- FCC Part 15 – Radiated & Conducted Emissions (USA)
- CAN ICES-3(A)/NMB-3(A) – Radiated & Conducted Emissions (Canada)
- CISPR 32 – Radiated & Conducted Emissions (International)
- EN55032: 2015 – Radiated & Conducted Emissions (European Union)
- EN55035:2017 – Immunity (European Union)
- EMC Directive 2014/30/EU
- Electromagnetic Compatibility Regulations 2016 (UK)
- VCCI (Class A)– Radiated & Conducted Emissions (Japan)
- CNS13438 – Radiated & Conducted Emissions (Taiwan)
- CNS 15663 - RoHS (Taiwan)
- AS/NZS CISPR 32 – Radiated and Conducted Emissions (Australia/New Zealand)
- Article 58-2 of Radio Waves Act, Clause 3 (Korea)

### Regulatory Compliance Markings

When required, these products are provided with the following Product Certification Markings:

- UL Listed Accessories Mark for the USA and Canada
- CE mark
- UKCA mark
- FCC markings

- VCCI marking
- Australian C-Tick mark
- Korea MSIP mark
- Taiwan BSMI mark

## FCC Class A User Information

The Class A products listed above comply with Part 15 of the FCC Rules. Operation is subject to the following two conditions:

1. This device may not cause harmful interference.
2. This device must accept any interference received, including interference that may cause undesired operation.

---

 **IMPORTANT!** *This equipment has been tested and found to comply with the limits for a Class A digital device, pursuant to Part 15 of the FCC rules. These limits are designed to provide reasonable protection against harmful interference when the equipment is operated in a commercial environment. This equipment generates, uses, and can radiate radio frequency energy and, if not installed and used in accordance with the instructions, may cause harmful interference to radio communications. Operation of this equipment in a residential area is likely to cause harmful interference, in which case the user will be required to correct the interference at his or her own expense.*

---

 **IMPORTANT!** *Cet équipement a été testé et jugé conforme à la Class A digital device, conformément à la règle 15 du standard FCC. Ces limites sont conçues pour fournir des protections contre des interférences nuisibles lorsque l'équipement est utilisé dans un environnement commercial. Cet équipement génère, utilise et peut émettre des énergies de radio-fréquence et, s'il n'est pas installé et utilisé conformément aux instructions, peut nuire aux communications radio. L'exploitation de cet équipement dans une zone résidentielle est susceptible de causer des interférences nuisibles, auquel cas l'utilisateur peut être tenu de prendre des mesures adéquates à ses propres frais.*

---

 **WICHTIG!** *Dieses Gerät wurde getestet und entspricht den Grenzwerten für digitale Geräte der Klasse A gemäß Teil 15 der FCC-Bestimmungen. Diese Grenzwerte bieten einen angemessenen Schutz gegen schädliche Interferenzen, wenn das Gerät in einer gewerblichen Umgebung betrieben wird. Dieses Gerät erzeugt und verwendet Hochfrequenzenergie und kann diese abstrahlen. Wenn es nicht gemäß den Anweisungen installiert und verwendet wird, kann dies Funkstörungen verursachen. Der Betrieb dieses Geräts in einem Wohngebiet kann schädliche Interferenzen verursachen. In diesem Fall muss der Benutzer die Interferenz auf eigene Kosten beheben.*

---

 **CAUTION!** *If the device is changed or modified without permission from AMD, the user may void his or her authority to operate the equipment.*

---

 **ATTENTION!** *Si l'appareil est modifié sans l'autorisation de AMD, l'utilisateur peut annuler son habilité à utiliser l'équipement.*

---

 **VORSICHT!** *Wenn das Gerät ohne Erlaubnis von AMD geändert wird, kann der Benutzer seine Berechtigung zum Betrieb des Geräts verlieren.*

---

## Canadian Compliance (Industry Canada)

CAN ICES-3(A)/NMB-3(A)

## China RoHS Compliance

- SJ/T 11363-2006, 11364-2006, and GB/T 26572-2011
- RoHS 3 directive 2015/863
- EU 2015/863

## VCCI Class A Statement

この装置は、クラス A 情報技術装置です。この装置を家庭環境で使用すると電波妨害を引き起こすことがあります。この場合には使用者が適切な対策を構ずるよう要求されることがあります。

VCCI-A

## KCC Notice Class A (Republic of Korea Only)

<p>A급 기기 (업무용 방송통신기기)</p> <p><b>CLASS A device</b> (commercial broadcasting and communication equipment)</p>	<p>이 기기는 업무용(A급)으로 전자파적합등록을 한 기기이오니 판매자 또는 사용자는 이 점을 주의하시기 바라며, 가정외의 지역에서 사용하는 것을 목적으로 합니다.</p> <p>This device has been approved by EMC registration. Distributors or users pay attention to this point. This device is usually aimed to be used in other area except at home</p>
--	---

## BSMI Class A Notice (Taiwan)

警告使用者:

此為甲類資訊技術設備，於居住環境中使用時，可能會造成射頻擾動，在此種情況下，使用者會被要求採取某些適當的對策。

## EU WEEE Logo

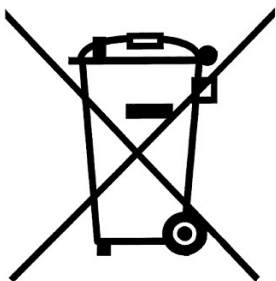

## Manufacturer Declaration European Community



### Manufacturer Declaration

AMD declares that the equipment described in this document is in conformance with the requirements of the European Council Directive listed below:

- Low Voltage Directive 2014/35/EU
- EMC Directive 2014/30/EU

These products follow the provisions of the European Directive 2014/53/EU.

Dette produkt er i overensstemmelse med det europæiske direktiv 2014/53/EU.

Dit product is in navolging van de bepalingen van Europees Directief 2014/53/EU.

Tämä tuote noudattaa EU-direktiivin 2014/53/EU määräyksiä.

Ce produit est conforme aux exigences de la Directive Européenne 2014/53/EU.

Dieses Produkt entspricht den Bestimmungen der Europäischen Richtlinie 2014/53/EU.

Pessi vara stenst reglugerð Evrópska Efnahags Bandalagsins númer 2014/53/EU.

Questo prodotto è conforme alla Direttiva Europea 2014/53/EU.

Dette produktet er i henhold til bestemmelsene i det europeiske direktivet 2014/53/EU.

Este produto cumpre com as normas da Diretiva Europeia 2014/53/EU.

Este producto cumple con las normas del Directivo Europeo 2014/53/EU.

Denna produkt har tillverkats i enlighet med EG-direktiv 2014/53/EU.

This declaration is based upon compliance of the Class A products listed above to the following standards:

EN 55032 (CISPR 32 Class A) RF Emissions Control.

EN 55024:2010 (CISPR 24) Immunity to Electromagnetic Disturbance.

EN 62368-1:2014/A11:2017 Information Technology Equipment

EN 50581:2012 - Technical documentation for the assessment of electrical and electronic products with respect to the restriction of hazardous substances.

---

 **CAUTION!** *In a domestic environment, Class A products may cause radio interference, in which case the user may be required to take adequate measures.*

---



**ATTENTION!** Dans un environnement domestique, les produits de Classe A peuvent causer des interférences radio, auquel cas l'utilisateur peut être tenu de prendre des mesures adéquates.

**VORSICHT!** In einer häuslichen Umgebung können Produkte der Klasse A Funkstörungen verursachen. In diesem Fall muss der Benutzer möglicherweise geeignete Maßnahmen ergreifen.

## Responsible Party

AMD, Inc.  
 2100 Logic Drive, San Jose, CA 95124  
 United States of America  
 Phone: (408) 559-7778

## References

These documents provide supplemental material useful with this data sheet:

1. *Getting Started with Alveo Data Center Accelerator Cards* ([UG1301](#))
2. *Alveo Programming Cable User Guide* ([UG1377](#))
3. *Alveo U55C Data Center Accelerator Card Installation Guide* ([UG1468](#))
4. *Alveo U55C Data Center Accelerator Card User Guide* ([UG1469](#))
5. *Alveo Out-of-Band Management Specification for Server BMC User Guide* ([UG1363](#))
6. *Card Management Solution Subsystem Product Guide* ([PG348](#))
7. *UltraScale+ Devices Integrated Block for PCI Express LogiCORE IP Product Guide* ([PG213](#))
8. *Vitis Unified Software Platform Documentation: Application Acceleration Development* ([UG1393](#))

## Revision History

The following table shows the revision history for this document.

Section	Revision Summary
<b>03/24/2023 Version 1.2</b>	
General updates	Moved QSFP port location figure from <a href="#">Summary</a> to <a href="#">Network Interfaces</a> .
<a href="#">Table 3: QSFP Port to Quad and Index Mapping</a>	Added table.
<b>09/01/2022 Version 1.1</b>	
<a href="#">Summary</a>	Added I/O bracket figure.
<a href="#">USB Maintenance Port</a>	Clarified sentence to say that the micro-USB maintenance port is located at the back of the card.
<a href="#">AUX Power Connector</a>	Clarified to say "8-pin PCIe AUX power connector."
<a href="#">Board and Temperature Limits</a>	Added section.
<b>11/12/2021 Version 1.0</b>	
Initial release.	N/A

## Please Read: Important Legal Notices

The information presented in this document is for informational purposes only and may contain technical inaccuracies, omissions, and typographical errors. The information contained herein is subject to change and may be rendered inaccurate for many reasons, including but not limited to product and roadmap changes, component and motherboard version changes, new model and/or product releases, product differences between differing manufacturers, software changes, BIOS flashes, firmware upgrades, or the like. Any computer system has risks of security vulnerabilities that cannot be completely prevented or mitigated. AMD assumes no obligation to update or otherwise correct or revise this information. However, AMD reserves the right to revise this information and to make changes from time to time to the content hereof without obligation of AMD to notify any person of such revisions or changes. THIS INFORMATION IS PROVIDED "AS IS." AMD MAKES NO REPRESENTATIONS OR WARRANTIES WITH RESPECT TO THE CONTENTS HEREOF AND ASSUMES NO RESPONSIBILITY FOR ANY INACCURACIES, ERRORS, OR OMISSIONS THAT MAY APPEAR IN THIS INFORMATION. AMD SPECIFICALLY DISCLAIMS ANY IMPLIED WARRANTIES OF NON-INFRINGEMENT, MERCHANTABILITY, OR FITNESS FOR ANY PARTICULAR PURPOSE. IN NO EVENT WILL AMD BE LIABLE TO ANY PERSON FOR ANY RELIANCE, DIRECT, INDIRECT, SPECIAL, OR OTHER CONSEQUENTIAL DAMAGES ARISING FROM THE USE OF ANY INFORMATION CONTAINED HEREIN, EVEN IF AMD IS EXPRESSLY ADVISED OF THE POSSIBILITY OF SUCH DAMAGES.

### **AUTOMOTIVE APPLICATIONS DISCLAIMER**

AUTOMOTIVE PRODUCTS (IDENTIFIED AS "XA" IN THE PART NUMBER) ARE NOT WARRANTED FOR USE IN THE DEPLOYMENT OF AIRBAGS OR FOR USE IN APPLICATIONS THAT AFFECT CONTROL OF A VEHICLE ("SAFETY APPLICATION") UNLESS THERE IS A SAFETY CONCEPT OR REDUNDANCY FEATURE CONSISTENT WITH THE ISO 26262 AUTOMOTIVE SAFETY STANDARD ("SAFETY DESIGN"). CUSTOMER SHALL, PRIOR TO USING OR DISTRIBUTING ANY SYSTEMS THAT INCORPORATE PRODUCTS, THOROUGHLY TEST SUCH SYSTEMS FOR SAFETY PURPOSES. USE OF PRODUCTS IN A SAFETY APPLICATION WITHOUT A SAFETY DESIGN IS FULLY AT THE RISK OF CUSTOMER, SUBJECT ONLY TO APPLICABLE LAWS AND REGULATIONS GOVERNING LIMITATIONS ON PRODUCT LIABILITY.

### **Copyright**

© Copyright 2021–2023 Advanced Micro Devices, Inc. AMD, the AMD Arrow logo, Alveo, Vitis, Vivado, and combinations thereof are trademarks of Advanced Micro Devices, Inc. OpenCL and the OpenCL logo are trademarks of Apple Inc. used by permission by Khronos. PCI, PCIe, and PCI Express are trademarks of PCI-SIG and used under license. Other product names used in this publication are for identification purposes only and may be trademarks of their respective companies.