

Click [here](#) to ask an associate for production status of specific part numbers.

Evaluates: DS2478

DS2478 Evaluation Kit

General Description

The DS2478 evaluation system (EV system) provides the hardware and software necessary to exercise the features of the DS2478. The EV system consists of five DS2478/DS28E40/DS28C40 devices in a 10-pin TDFN package, two DS9121ATB+ TDFN socket boards along with a DS9481P-300# USB-to-I²C/1-Wire[®] adapter. The evaluation software runs under Windows[®] 10, Windows 8, and Windows 7 operating systems, both 64-bit and 32-bit versions. It provides a convenient user interface to exercise the features of the DS2478 in conjunction with DS28E40 or DS28C40.

DS2478 EV Kit Files

FILE	DESCRIPTION
DS2478_Evaluation_Kit_Lite_Version_Setup_V1_0.exe	Installation Package

Benefits and Features

- Demonstrates the Features of the DS2478 DeepCover[®] ECDSA Secure 1-Wire and I²C Authenticators.
- Communication is Logged to Aid Firmware Designer's Understanding of DS2478 and the DS28E40/DS28C40 Authenticators
- 1-Wire/I²C USB Adapter Creates a Virtual COM Port on any PC
- Fully Compliant with USB Specification v2.0
- Software Runs on Windows 10, Windows 8, and Windows 7 for both 64-Bit and 32-Bit Versions
- 3.3V ±3% 1-Wire Operating Voltage
- Evaluation Software Available by Request

[Ordering Information](#) appears at end of data sheet.

DS2478 EV Kit Board Photo

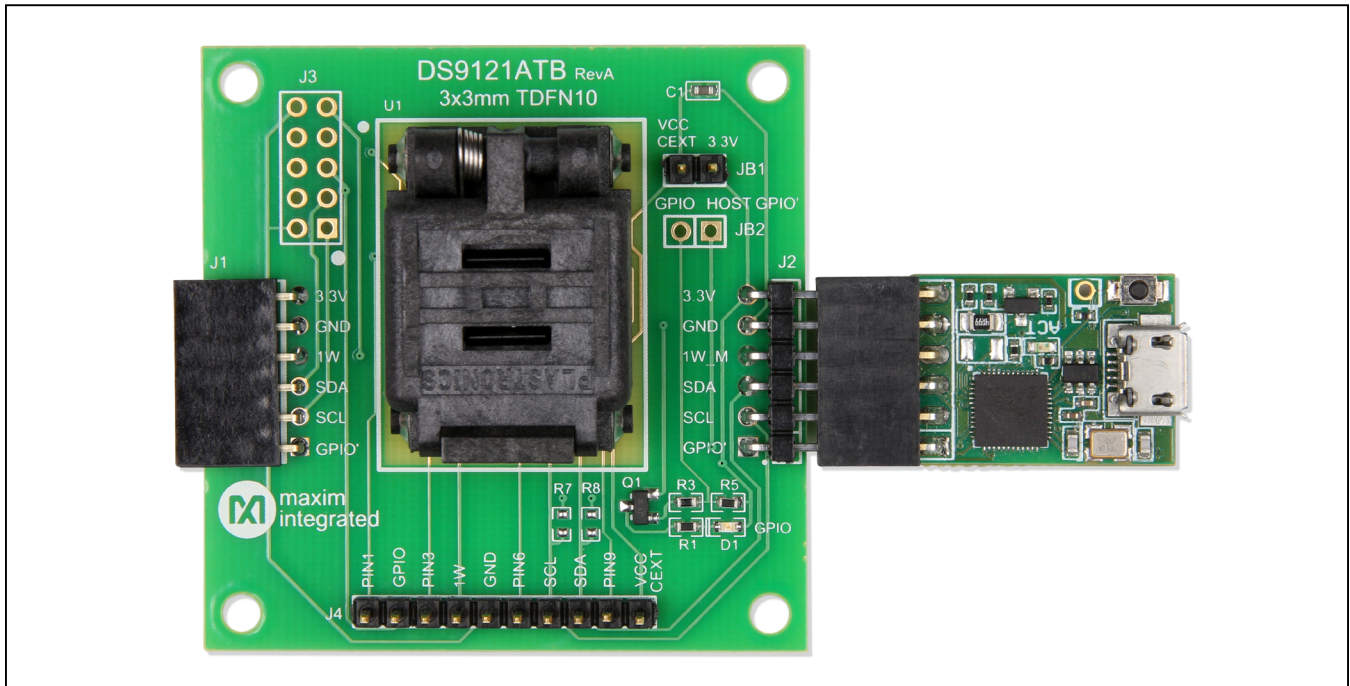

1-Wire and DeepCover are registered trademarks of Maxim Integrated Products, Inc.
Windows is a registered trademark and registered service mark of Microsoft Corporation.

319-100885; Rev 1; 3/22

DS2478 EV Kit Contents

QTY	DESCRIPTION
5	DS2478ATB/VY+ DeepCover Secure Coprocessor (10 TDFN)
5	DS28E40ATB/VY+ DeepCover Secure Authenticator (10 TDFN)
5	DS28C40ATB/VY+ DeepCover Secure Authenticator (10 TDFN)
2	DS9121ATB+ Socket Board (10 TDFN)
1	DS9481P-300# USB to I ² C/1-Wire Adapter
1	USB Type-A to Micro-USB Type-B Cable

Quick Start

This section includes a list of recommended equipment and instructions to set up the Windows-based PC for the evaluation software.

Required Equipment

- DS9481P-300# USB to I²C/SPI/1-Wire Adapter (included)
- DS9121ATB+ socket board (two included)
- DS28E40ATB/VY+ (five devices included)
- DS28C40ATB/VY+ (five devices included)

- DS2478ATB+ (five devices included)
- USB Type A to Micro-USB Type B cable (included)
- PC with a Windows 10, Windows 8, or Windows 7 operating system (64 bit or 32 bit) and a spare USB 2.0 or higher port
- Download [DS2478 Evaluation kit software light version](#) or request full DS2478 Evaluation kit developer software.

Note: In the following sections, software-related items are identified by **bolding**. Text in **bold** refers to items directly from the EV kit software. Text in **bold and underlined** refers to items from the Windows operating system

Hardware Setup and Driver Installation

Use the following steps on a Windows 10 PC to set up the DS2478 EV kit hardware/software:

- 1) Download and unzip the **DS2478_Evaluation_Kit_Lite_Version_Setup_V1_0_0** file or the latest version. **NOTE:** Running the setup from within the zip window without fully extracting it may cause installation issues. Make sure that the files are unzipped to a folder before proceeding.
- 2) In a file viewer ([Figure 1](#)), double click on the **DS2478_Evaluation_Kit_Lite_Version_Setup_V1_0_0.exe** file to begin the installation.

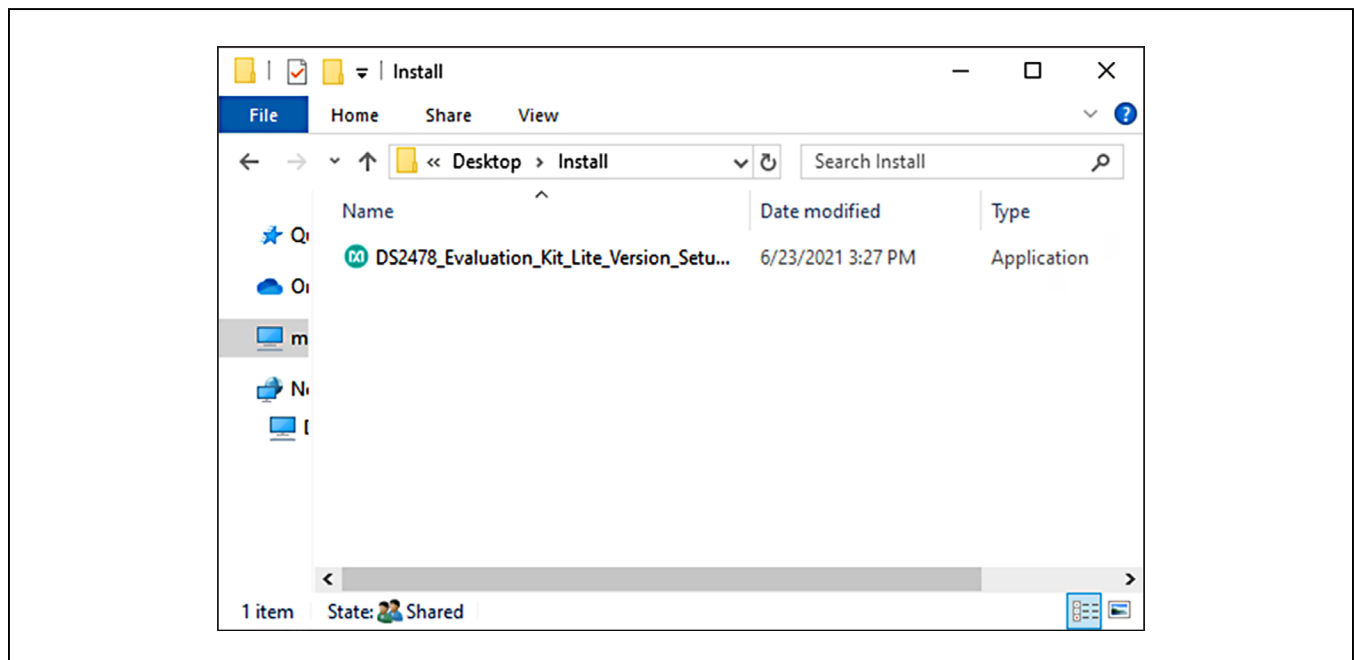

Figure 1. File Viewer

3) The setup wizard opens, click **Next** as shown in [Figure 2](#).

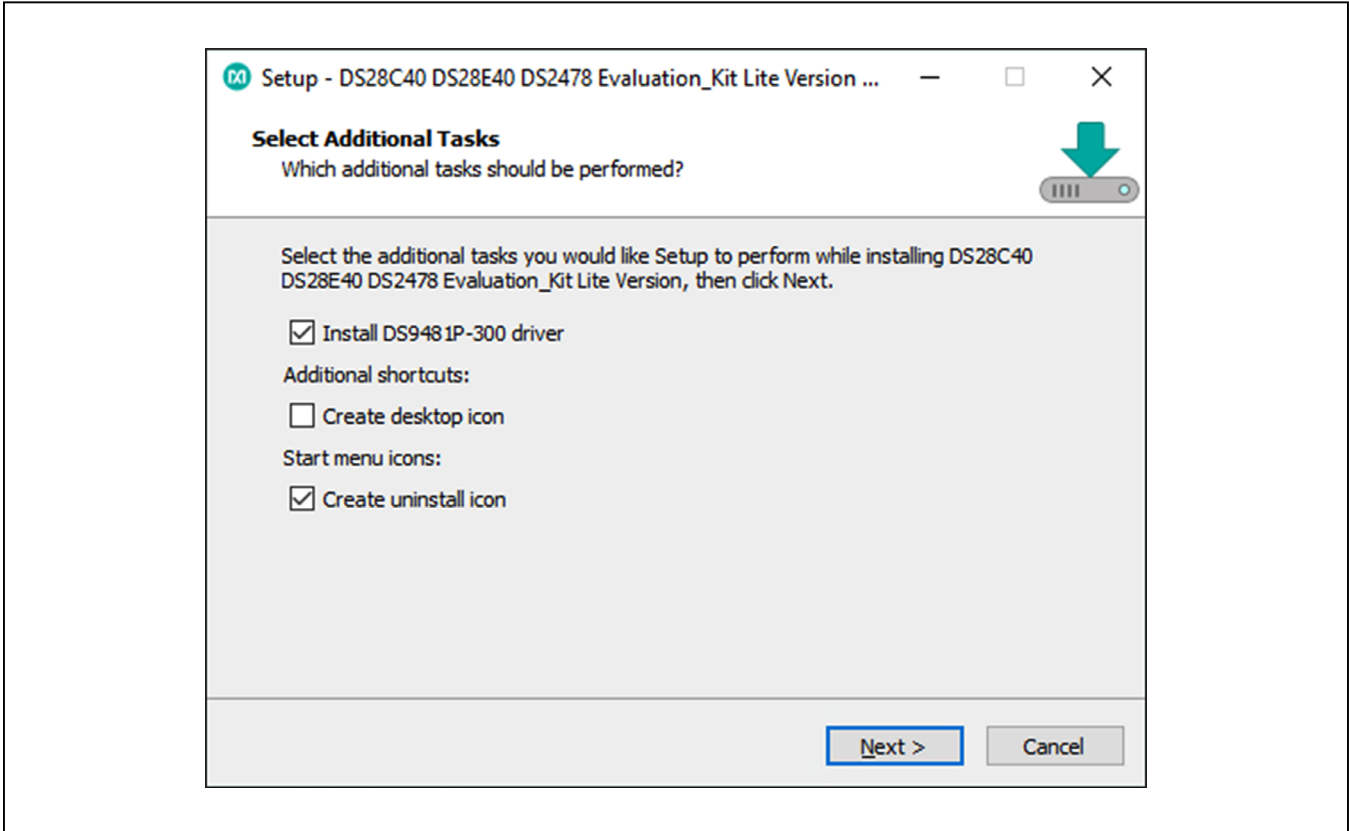

Figure 2. DS2478 Setup Wizard

- 4) Follow the instructions in the wizard and click **Next** to install the EV kit software and required drivers (Figures 3 and 4).
- 5) Wait for the installation to complete and **launch** the program if desired after completion (Figure 5).

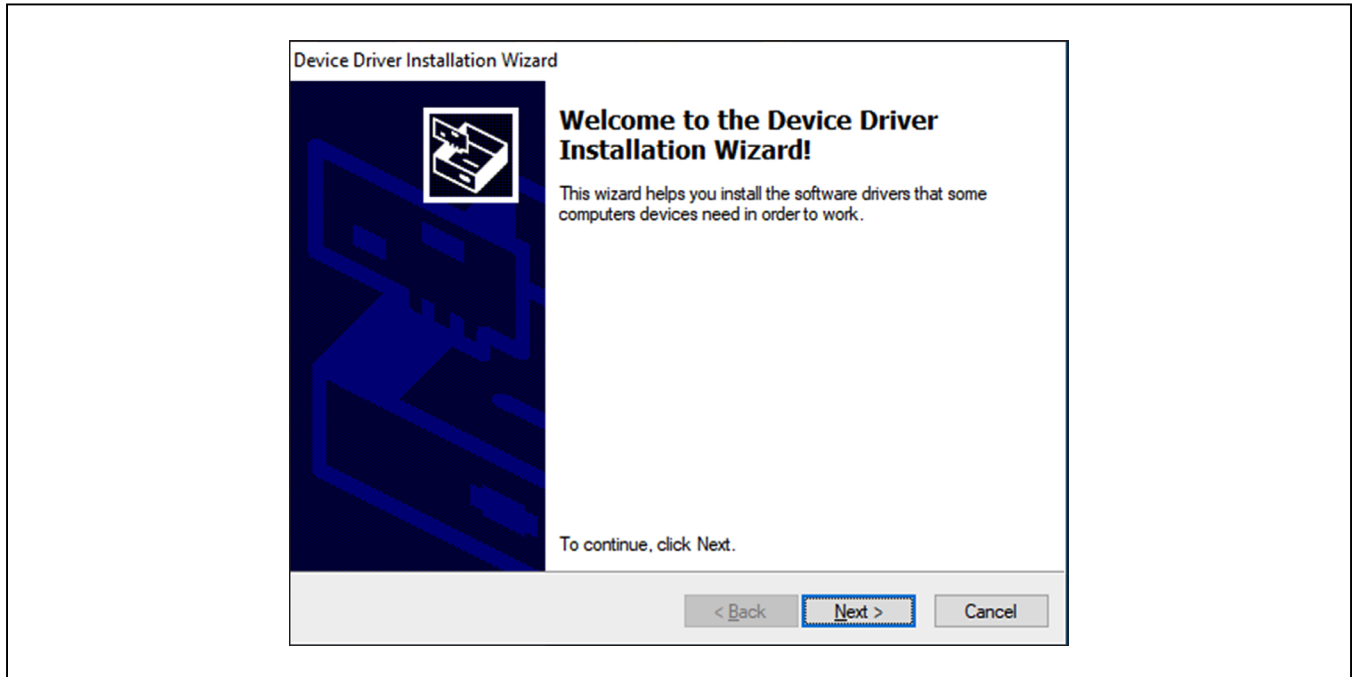

Figure 3. DS9481P-300# Driver Installation

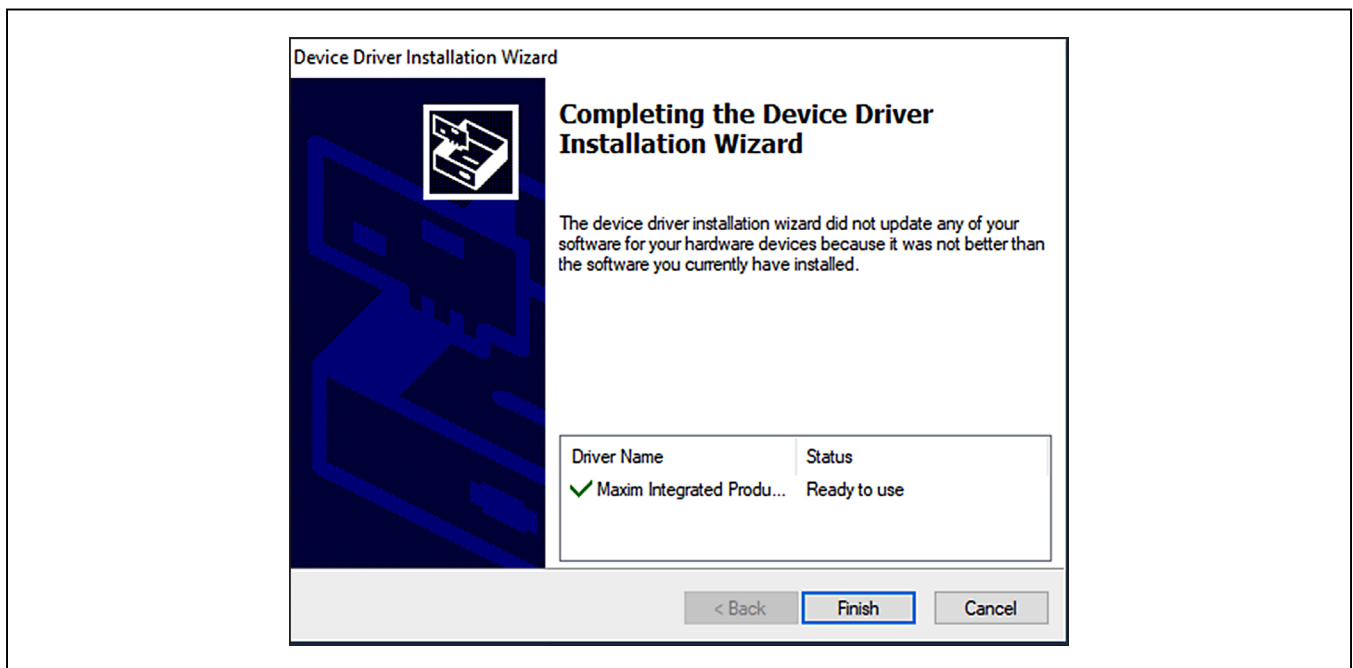

Figure 4. Finish DS9481P-300# Drivers Installation

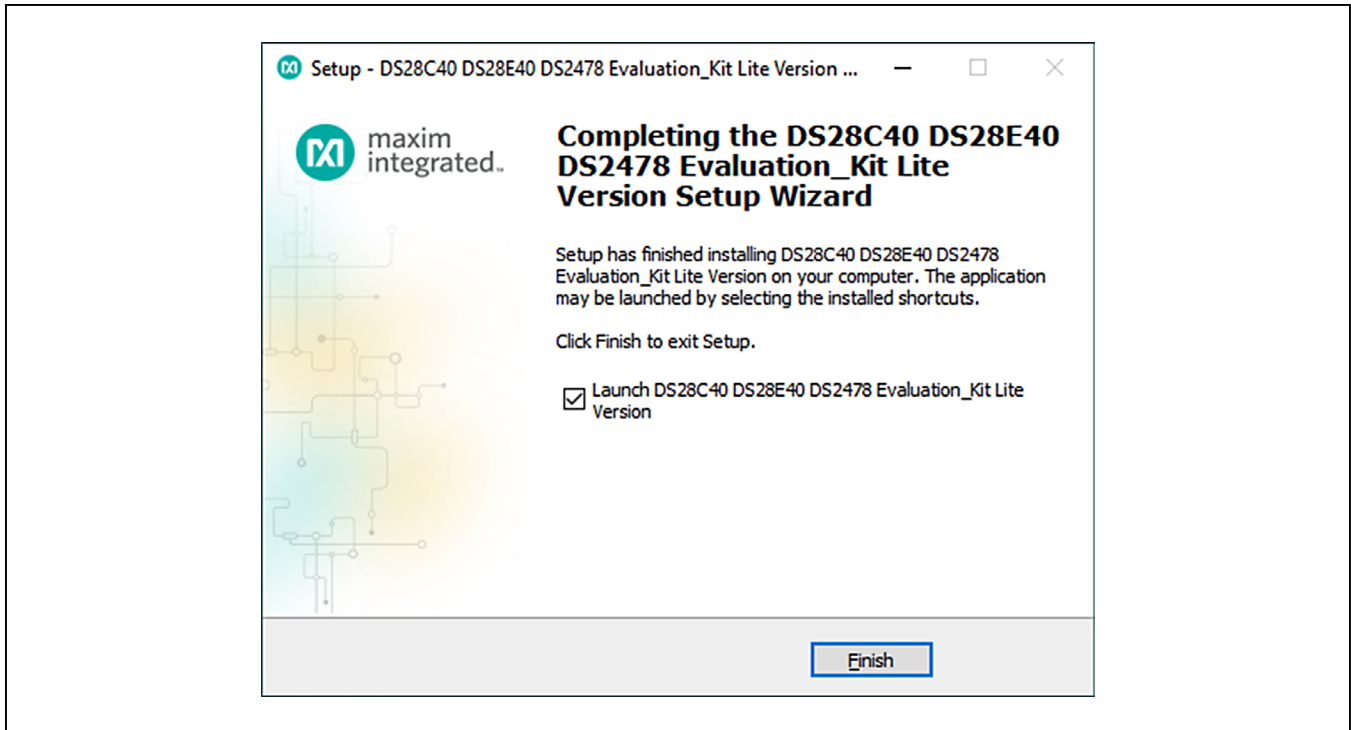

Figure 5. Run Software After Installation

- 6) Use the following steps to plug the DS9481P-300# into the PC with DS9121ATB+ socket board:
 - a) Open the socket and insert a DS2478ATB/VY+ as shown in [Figure 6](#). **Note:** The plus (+) on the package must be aligned with pin 1 located next to the upper left corner of the socket's marking.
 - b) Close the socket.
 - c) **Connect** the DS9121ATB+ J2 6-pin male plug into the DS9481P-300# 6-pin female socket, as shown in [Figure 7](#).
 - d) Insert VCC jumper JB1 ([Figure 7](#)) for the DS9121ATB+ board with the DS2478.
 - e) **Connect** the DS2478 EV kit to the PC using a USB Type-A to Micro-USB Type-B cable.
- 7) The DS2478 EV kit program opens and automatically connects to the COM port. This is shown in the status bar shown in [Figure 8](#).
- 8) The DS2478 EV kit supports both the DS28C40 and DS28E40. **Follow** step 6 to daisy chain an authenticator to the DS2478 coprocessor board. **Remove** the JB1 jumper from the DS9121ATB+ socket board when using DS28E40.

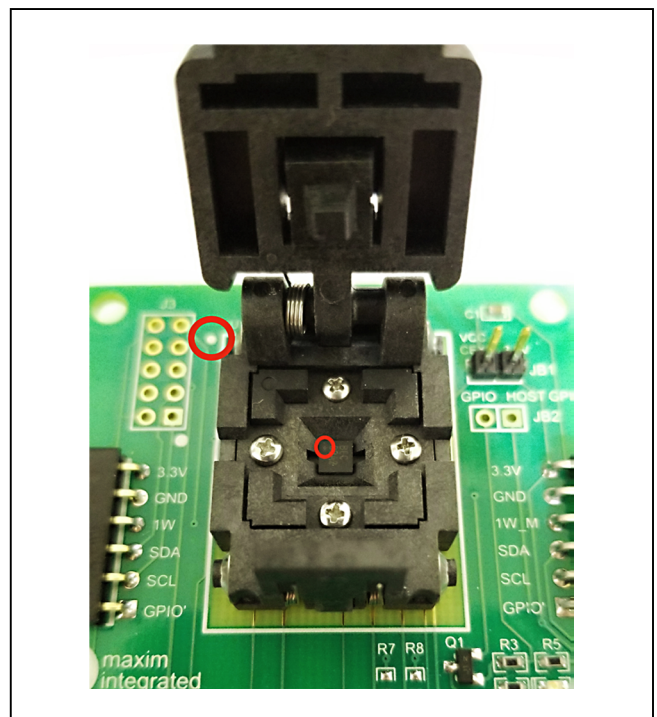

Figure 6. Orientation of the DS2478 in Burn-in Socket

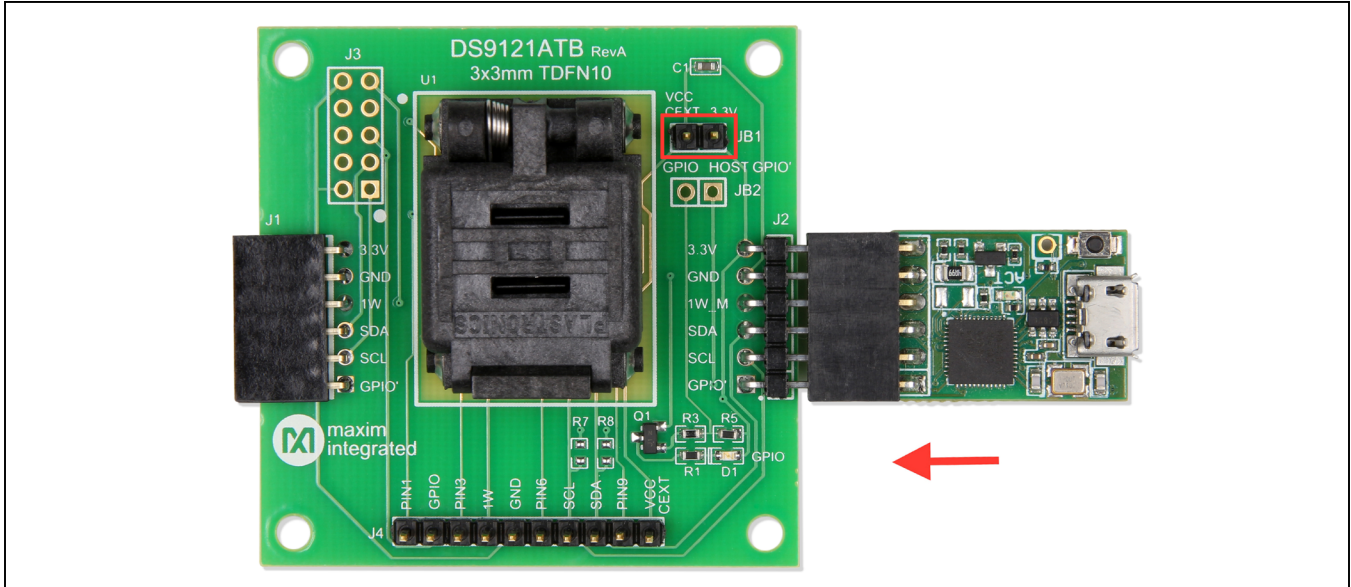

Figure 7. DS9481P-300 and DS9121ATB

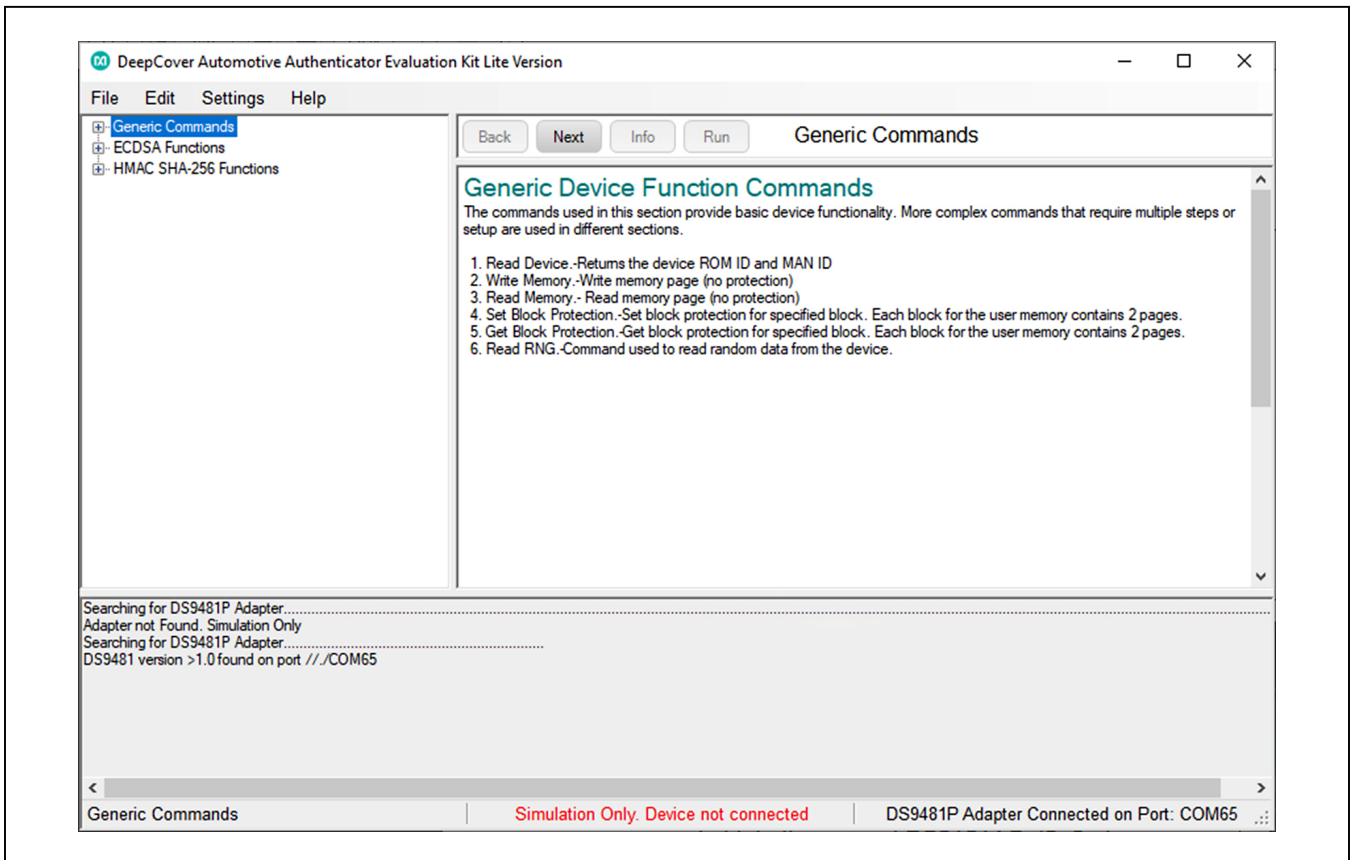

Figure 8. DS2478 EV Kit Program (Default View Upon Opening)

- 9) **Select DS2478** by going to **Settings** → **Select Device** → **DS2478** (Figure 9). The Software will connect to the DS2478 and enable the functions to evaluate the device. The connection status can be verified in the data log as shown in Figure 10.

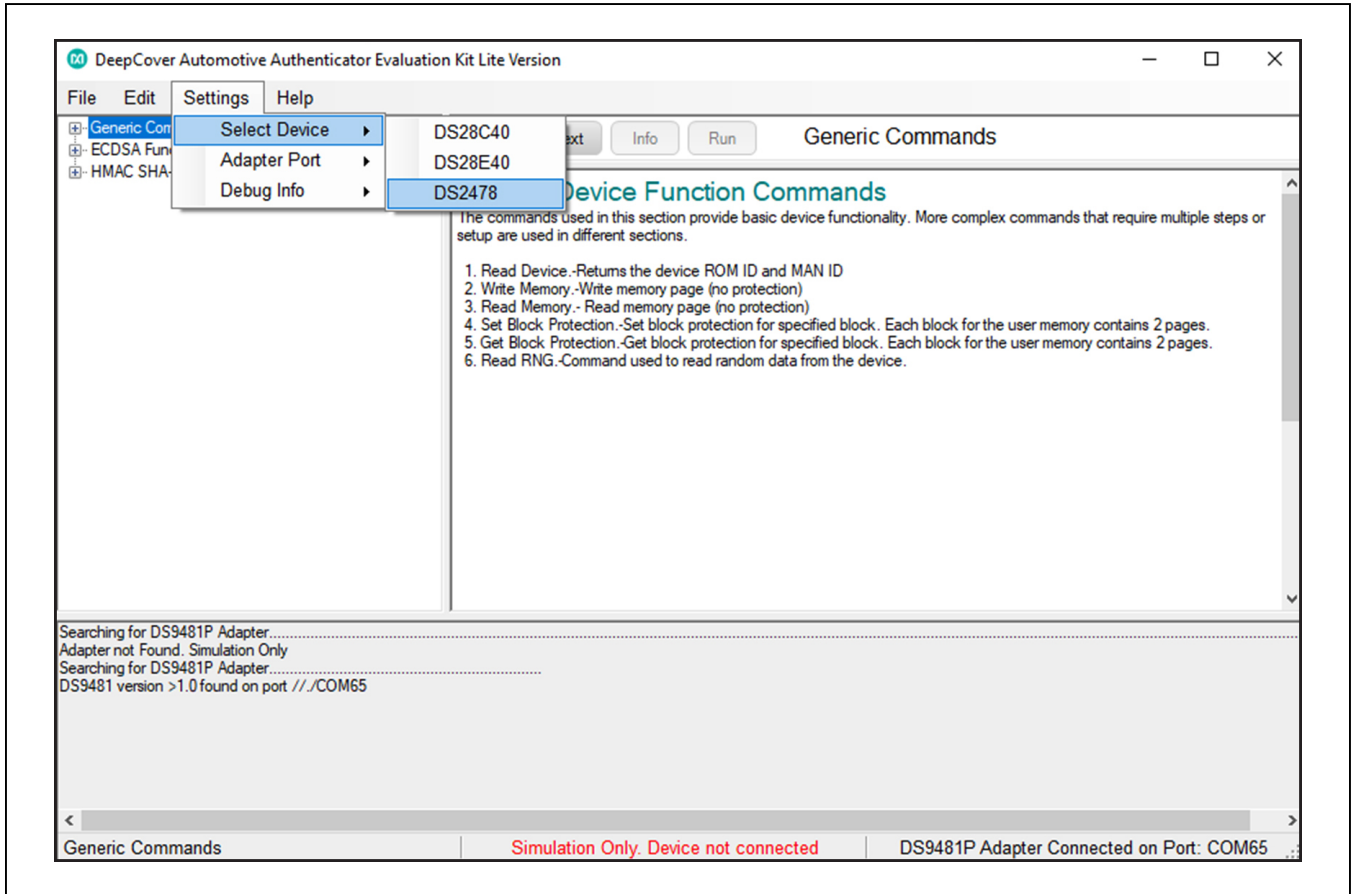

Figure 9. Select Device to Evaluate

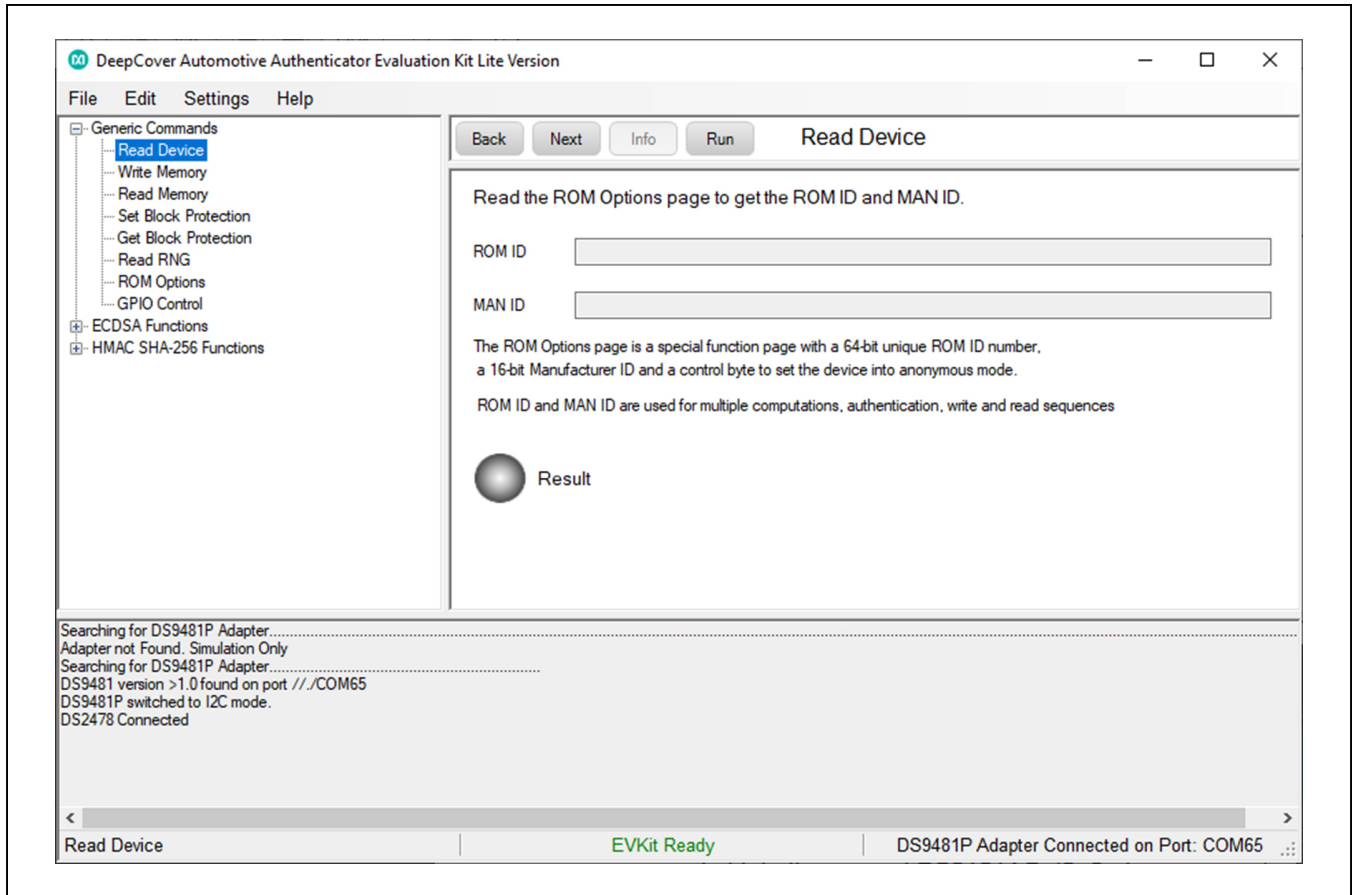

Figure 10. Software Ready

EV Kit Supported Functions

The DS2478 EV kit program is designed as a usage example. The GUI optionally displays all the device command sequence transactions as well as SHA and ECDSA computations when **Settings** → **Debug Info** is enabled. See [Table 1](#) for descriptions of the functions in the GUI.

Navigating

The DS2478 EV Kit Lite Program is divided in four sections: The top menu bar, functions selection, command panel and data log.

- **Menu Bar:** Provides access to settings, configuration, hardware selection and other features and information used to support the software operations.
- **Functions Panel:** Access to the device demonstration sequences.

- **Command Panel:** Sequence output, configuration, and command execution.
- **Data Log:** Provides information for command execution, and software operation.

Connection and Detecting Hardware

The DS9481P-300# adapter automatically connects to a COM port on software initialization. Alternatively, the adapter can be connected by selecting **Settings** → **Adapter Port** → **Connect**.

The DS2478 EV Kit Lite supports both the DS28E40 and DS28C40. The program requires a device selection for correct operation and hardware interface connection. Select the DS2478 to initiate device detection by selecting **Settings** → **Select Device** → **DS2478** (See [Figures 9](#) and [10](#)).

Table 1. GUI Setup and Usage Flows Supported

FLOW	DESCRIPTION
Generic Commands	Generic non-cryptographic DS2478 commands (e.g., Read Device, Read and Write Memory, Set and Read Protection and RNG function).
ECDSA Functions*	Examples to set up the device for ECDSA authentication, certificate generation, and verification. Examples for ECDSA encryption, authentication, signature generation, and verification.
HMAC SHA-256 Functions*	Examples provided to set up the device for HMAC authentication and verification and for HMAC encryption, authentication, and the SHA-256 generator.
Coprocessor Functions*	When selecting DS28C40 or DS2840 the DS2478 is used as a coprocessor and provides ECDSA and SHA2 tools required to authenticate the DS28E40 or DS28C40.

*Available only in full EV kit version.

Ordering Information

PART	TYPE
DS2478EVKIT#	EV Kit

#Denotes RoHS compliance.

DS2478 EV Kit Bill of Materials

DESIGNATOR	QTY	DESCRIPTION
Pack-Out	1	1-Wire Authenticator EV Kit DS2478EVKIT#
Pack-Out	5	AUTOMOTIVE 1-WIRE AUTHENTICATOR (DS28E40)
Pack-Out	5	AUTOMOTIVE I2C AUTHENTICATOR (DS28C40)
Pack-Out	5	AUTOMOTIVE I2C COPROCESSOR (DS2478)
Pack-Out	1	CABLE, USB A-TO-MICRO-B CABLE (1M) 68784-0001
Pack-Out	2	1W/I2C 3x3MM TDFN SOCKET BOARD DS9121ATB+
Pack-Out	1	DS9481P-300 EVAL KIT# DS9481P-300#
DS9121ATB+ PCB	1	PCB+, DS9121ATB+
J4	1	CONN HEADER VERT 10POS 2.54MM 22284103
J2	0.01	CONN+, HEADER, 50PS, 100 SGL, R/A, AU TSW-150-08-G-S-RA
J1	1	CONN+, RCPT, 100" 6POS, R/A GOLD PTPC061LGBN-RC
U1	1	SOCKET+, IC, TDFN10, 3x3MM, CLAMSHELL 10QH50A13030
Pack-Out	1	LABEL BLANK THT-1-423 0.75 X 0.25
Pack-Out	1	BAG, STATIC SHIELDZIP4X6, W/ ESD LO
C1	1	CAP+ 1.5 μ F
D1	1	LED+, GREEN CLEAR, 3.2V, 20MA, 0603 598-8081-107F
JB1	0.1	HEADER 36-40 PINS (CUT TO FIT) 22-28-4363
Populate to JB1	1	SHUNT+, LP W/HANDLE 2 POS 30AU 881545-2
Q1	1	MOSFET, N-CH ENHANCEMENT BSS138LT1G
R3	1	3.3k Ω 1% RESISTOR (0603 PB FREE) ERJ-3EKF3301V
R1, R5	2	RES, 10k Ω 1% 060

DS2478 EV Kit Schematic Diagram

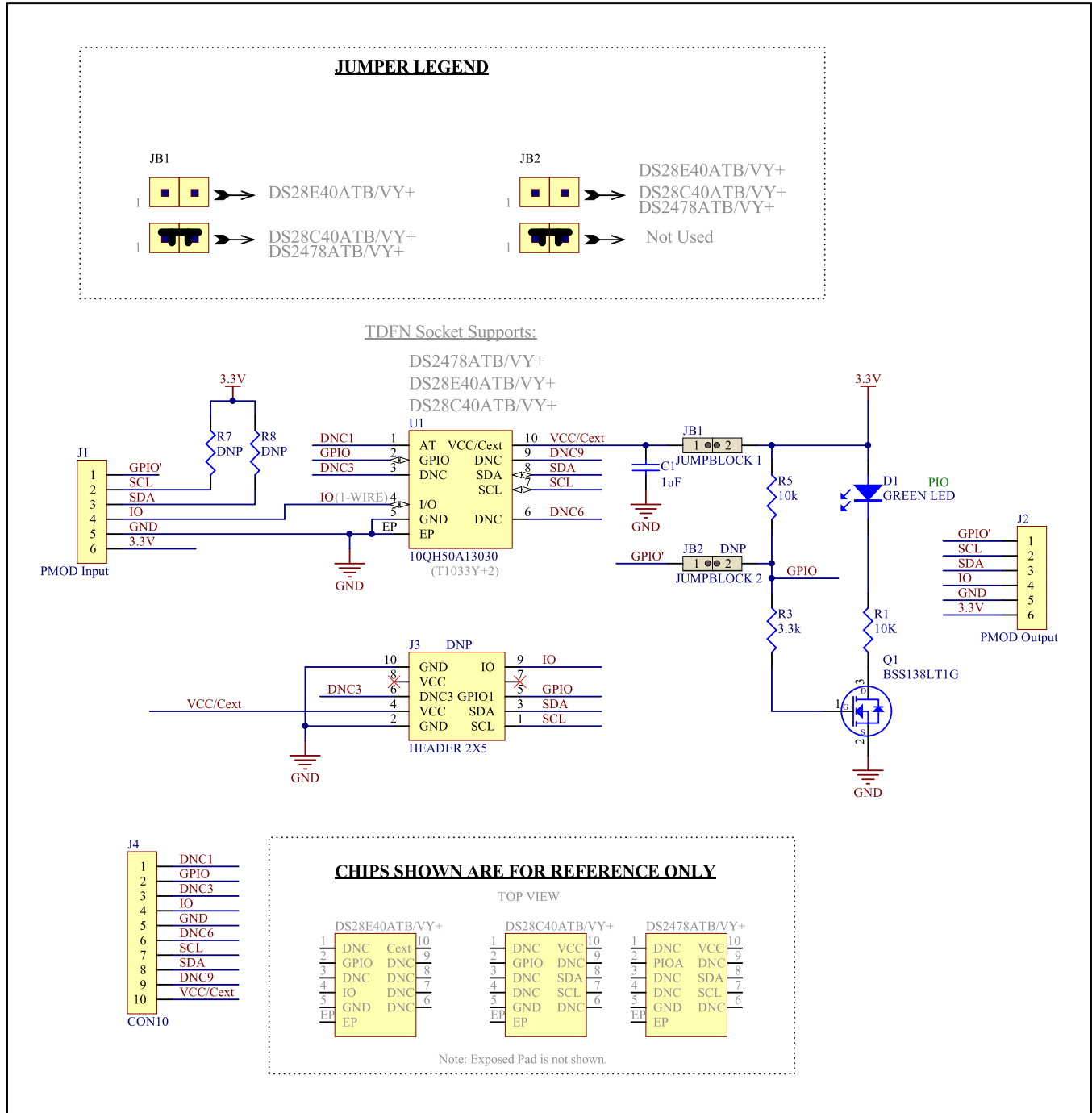

DS2478 EV Kit PCB Layout Diagrams

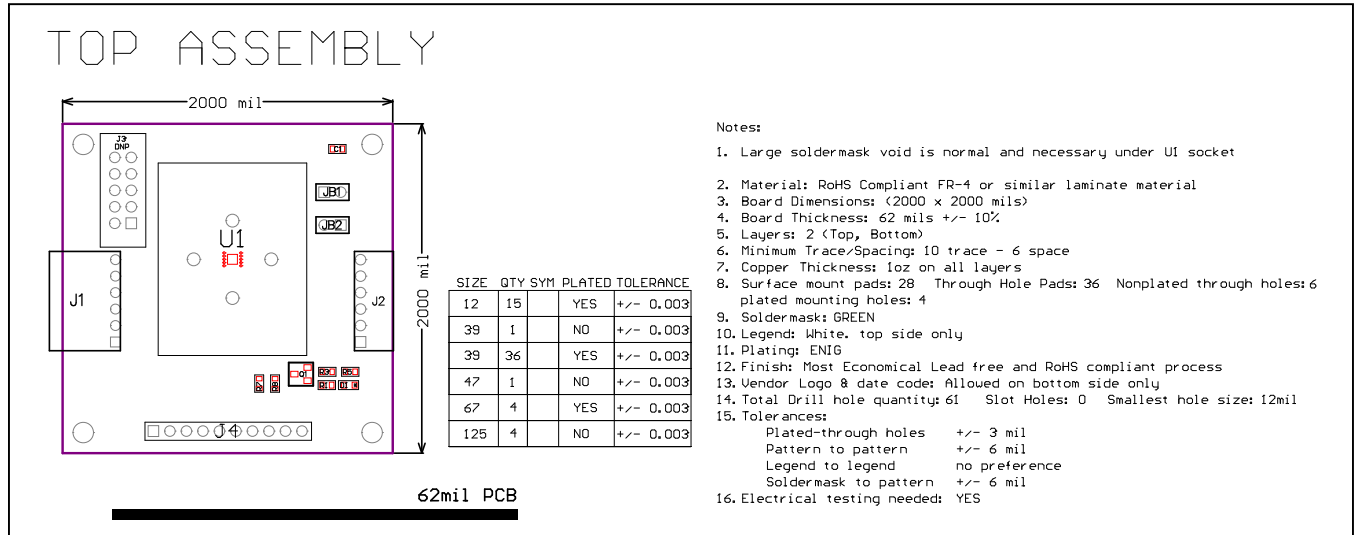

DS2478 EV Kit—PCB Layout Top Assembly

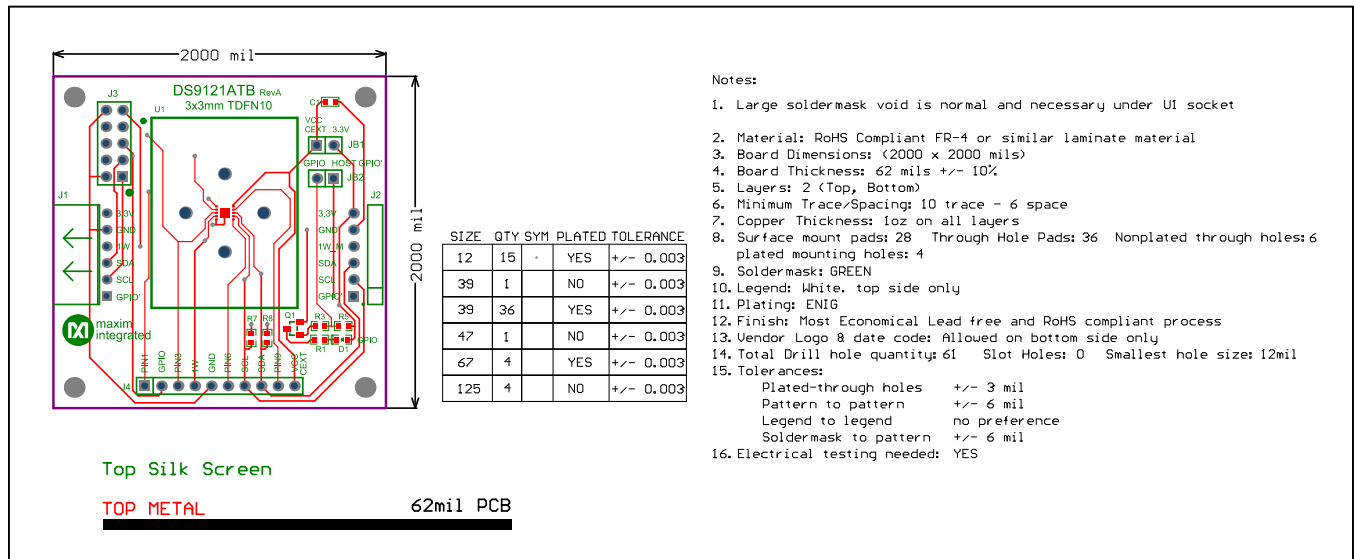

DS2478 EV Kit—PCB Layout Top Silkscreen

DS2478 EV Kit PCB Layout Diagrams (continued)

SIZE	QTY	SYM	PLATED	TOLERANCE
12	15	.	YES	+/- 0.003
39	1		NO	+/- 0.003
39	36		YES	+/- 0.003
47	1		NO	+/- 0.003
67	4		YES	+/- 0.003
125	4		NO	+/- 0.003

62mil PCB
Bottom Metal IsM mottorB

Notes:

1. Large soldermask void is normal and necessary under UI socket
2. Material: RoHS Compliant FR-4 or similar laminate material
3. Board Dimensions: (2000 x 2000 mils)
4. Board Thickness: 62 mils +/- 10%
5. Layers: 2 (Top, Bottom)
6. Minimum Trace/Spacing: 10 trace - 6 space
7. Copper Thickness: 1oz on all layers
8. Surface mount pads: 28 Through Hole Pads: 36 Nonplated through holes: 6 plated mounting holes: 4
9. Soldermask: GREEN
10. Legend: White, top side only
11. Plating: ENIG
12. Finish: Most Economical Lead free and RoHS compliant process
13. Vendor Logo & date code: Allowed on bottom side only
14. Total Drill hole quantity: 61 Slot Holes: 0 Smallest hole size: 12mil
15. Tolerances:
 - Plated-through holes +/- 3 mil
 - Pattern to pattern +/- 6 mil
 - Legend to legend no preference
 - Soldermask to pattern +/- 6 mil
16. Electrical testing needed: YES

DS2478 EV Kit—PCB Layout Bottom Metal

SIZE	QTY	SYM	PLATED	TOLERANCE
12	15	□	YES	+/- 0.003
39	1	∇	NO	+/- 0.003
39	36	◇	YES	+/- 0.003
47	1	○	NO	+/- 0.003
67	4	⊗	YES	+/- 0.003
125	4	○	NO	+/- 0.003

62mil PCB

Notes:

1. Large soldermask void is normal and necessary under UI socket
2. Material: RoHS Compliant FR-4 or similar laminate material
3. Board Dimensions: (2000 x 2000 mils)
4. Board Thickness: 62 mils +/- 10%
5. Layers: 2 (Top, Bottom)
6. Minimum Trace/Spacing: 10 trace - 6 space
7. Copper Thickness: 1oz on all layers
8. Surface mount pads: 28 Through Hole Pads: 36 Nonplated through holes: 6 plated mounting holes: 4
9. Soldermask: GREEN
10. Legend: White, top side only
11. Plating: ENIG
12. Finish: Most Economical Lead free and RoHS compliant process
13. Vendor Logo & date code: Allowed on bottom side only
14. Total Drill hole quantity: 61 Slot Holes: 0 Smallest hole size: 12mil
15. Tolerances:
 - Plated-through holes +/- 3 mil
 - Pattern to pattern +/- 6 mil
 - Legend to legend no preference
 - Soldermask to pattern +/- 6 mil
16. Electrical testing needed: YES

DS2478 EV Kit—PCB Layout Layout Drill and Mechanical

DS2478 EV Kit PCB Layout Diagrams (continued)

SIZE	QTY	SYM	PLATED	TOLERANCE
12	15	-	YES	+/- 0.003
39	1	-	NO	+/- 0.003
39	36	-	YES	+/- 0.003
47	1	-	NO	+/- 0.003
67	4	-	YES	+/- 0.003
125	4	-	NO	+/- 0.003

62mil PCB

Notes:

1. Large soldermask void is normal and necessary under UI socket
2. Material: RoHS Compliant FR-4 or similar laminate material
3. Board Dimensions: (2000 x 2000 mils)
4. Board Thickness: 62 mils +/- 10%
5. Layers: 2 (Top, Bottom)
6. Minimum Trace/Spacing: 10 trace - 6 space
7. Copper Thickness: 1oz on all layers
8. Surface mount pads: 28 Through Hole Pads: 36 Nonplated through holes: 6 plated mounting holes: 4
9. Soldermask: GREEN
10. Legend: White, top side only
11. Plating: ENIG
12. Finish: Most Economical Lead free and RoHS compliant process
13. Vendor Logo & date code: Allowed on bottom side only
14. Total Drill hole quantity: 61 Slot Holes: 0 Smallest hole size: 12mil
15. Tolerances:
 - Plated-through holes +/- 3 mil
 - Pattern to pattern +/- 6 mil
 - Legend to legend no preference
 - Soldermask to pattern +/- 6 mil
16. Electrical testing needed: YES

DS2478 EV Kit—PCB Layout Bottom Layer

Revision History

REVISION NUMBER	REVISION DATE	DESCRIPTION	PAGES CHANGED
0	2/22	Initial release	—
1	3/22	Updated URL for user guide request; updated Required Equipment	1, 2



Information furnished by Analog Devices is believed to be accurate and reliable. However, no responsibility is assumed by Analog Devices for its use, nor for any infringements of patents or other rights of third parties that may result from its use. Specifications subject to change without notice. No license is granted by implication or otherwise under any patent or patent rights of Analog Devices. Trademarks and registered trademarks are the property of their respective owners.