

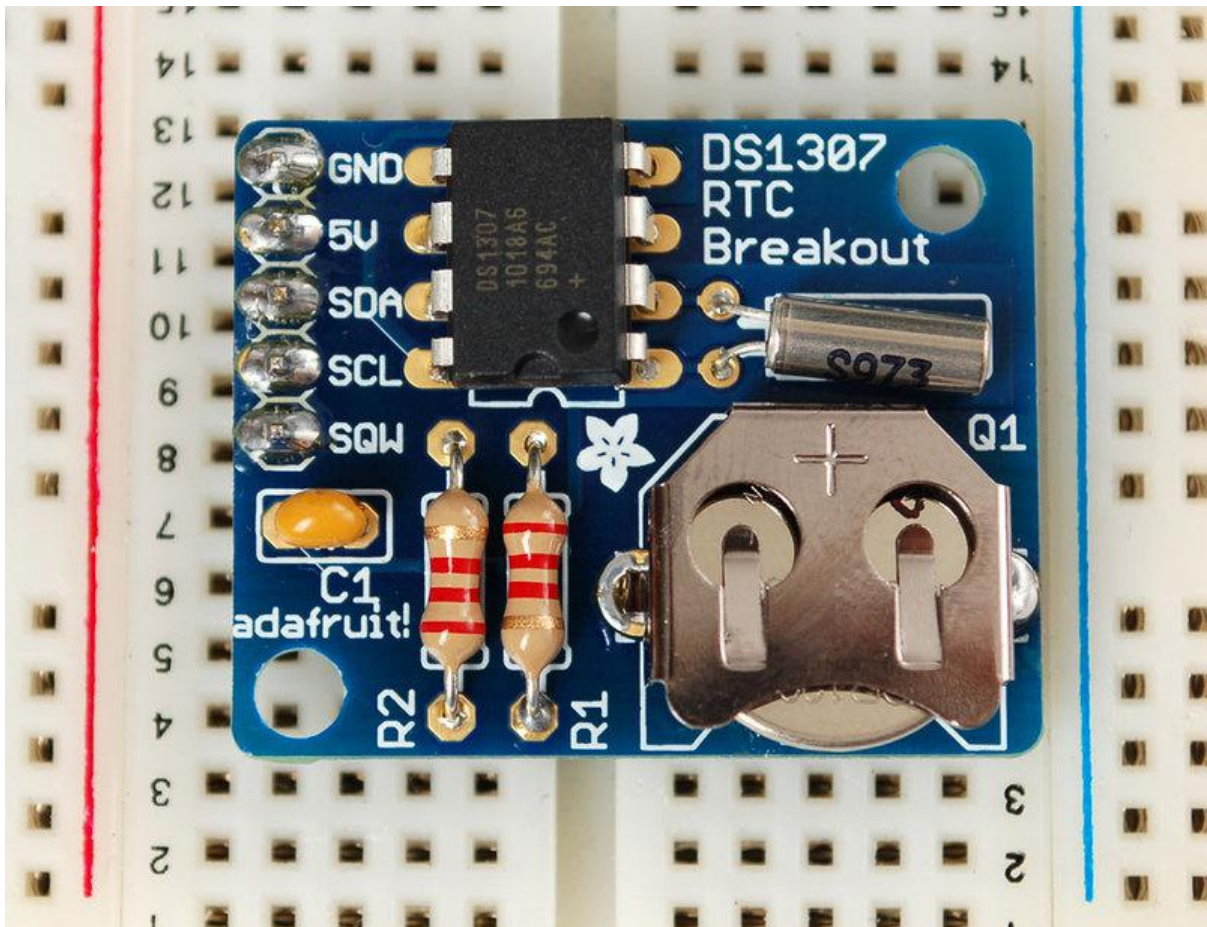

DS1307 Real Time Clock Breakout Board Kit

Created by Tyler Cooper



<https://learn.adafruit.com/ds1307-real-time-clock-breakout-board-kit>

Last updated on 2023-08-29 02:15:36 PM EDT

Table of Contents

| | |
|------------------------------------|----|
| Overview | 3 |
| What is an RTC? | 3 |
| • Battery Backup | |
| Parts List | 5 |
| Assembly | 7 |
| Wiring It Up | 12 |
| • Fun Plug-in Hack for Arduino UNO | |
| Arduino Library | 14 |
| • Talking to the RTC | |
| • Install Adafruit_RTCLib library | |
| Understanding the Code | 15 |
| • First RTC Test | |
| • Setting the Time | |
| • Reading the Time | |
| Downloads | 18 |
| • Datasheets & Files | |
| • Schematic | |
| • Fabrication Print | |

Overview

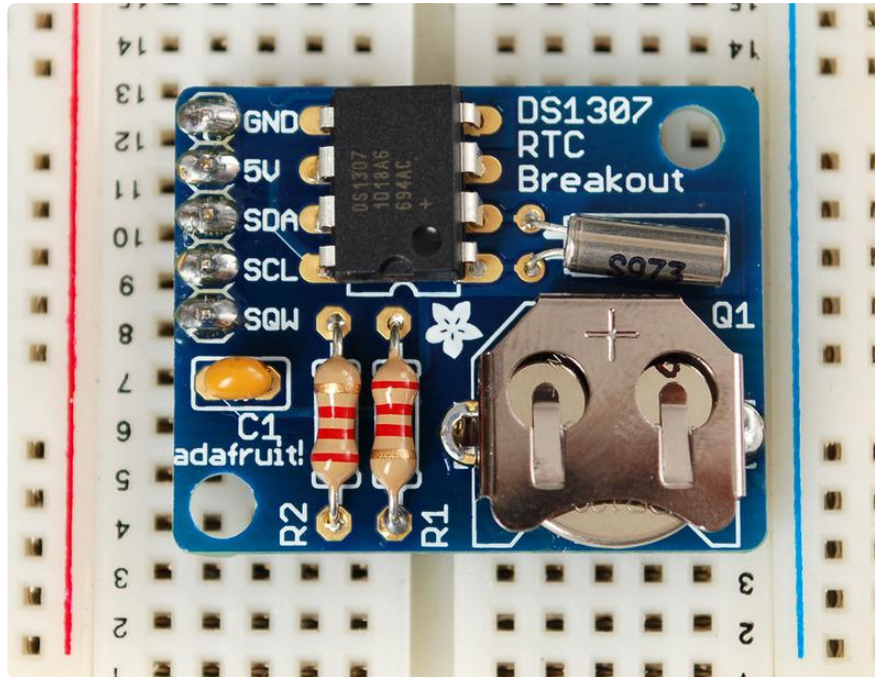

This is a great battery-backed real time clock (RTC) that allows your microcontroller project to keep track of time even if it is reprogrammed, or if the power is lost. Perfect for datalogging, clock-building, time stamping, timers and alarms, etc. The DS1307 is the most popular RTC, and works best with 5V-based chips such as the Arduino.

- All parts including PCB, header and battery are included
- Quick to assemble and use
- Plugs into any breadboard, or you can use wires
- We have example code and library for Arduino with a walkthrough on our documentation page
- Two mounting holes
- Will keep time for 5 years or more

This breakout board is a kit and requires some light soldering which should only take about 15 minutes.

What is an RTC?

A real time clock is basically just like a watch - it runs on a battery and keeps time for you even when there is a power outage! Using an RTC, you can keep track of long timelines, even if you reprogram your microcontroller or disconnect it from USB or a power plug.

Most microcontrollers, including the Arduino, have a built-in timekeeper called millis() and there are also timers built into the chip that can keep track of longer time periods like minutes or days. So why would you want to have a separate RTC chip? Well, the biggest reason is that millis() only keeps track of time since the Arduino was last powered - . That means that when the power is turned on, the millisecond timer is set back to 0. The Arduino doesn't know that it's 'Tuesday' or 'March 8th', all it can tell is 'It's been 14,000 milliseconds since I was last turned on'.

OK so what if you wanted to set the time on the Arduino? You'd have to program in the date and time and you could have it count from that point on. But if it lost power, you'd have to reset the time. Much like very cheap alarm clocks: every time they lose power they blink 12:00

While this sort of basic timekeeping is OK for some projects, some projects such as data-loggers, clocks, etc will need to have consistent timekeeping that doesn't reset when the Arduino battery dies or is reprogrammed. Thus, we include a separate RTC! The RTC chip is a specialized chip that just keeps track of time. It can count leap-years and knows how many days are in a month, but it doesn't take care of Daylight Savings Time (because it changes from place to place)



The image above shows a computer motherboard with a Real Time Clock called the [DS1387](#) (). There's a lithium battery in there which is why it's so big.

The RTC we'll be using is the [DS1307](#) (). It's low cost, easy to solder, and can run for years on a very small coin cell.

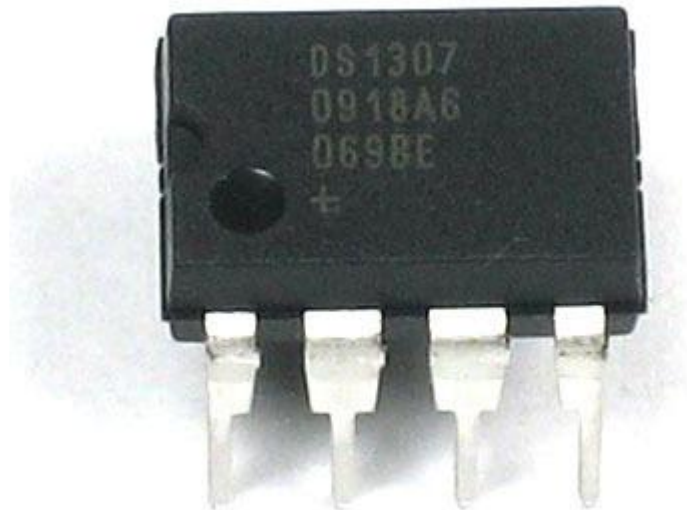

Battery Backup

As long as it has a coin cell to run it, the RTC will merrily tick along for a long time, even when the Arduino loses power, or is reprogrammed.

Use any CR1220 3V lithium metal coin cell battery:



[CR1220 12mm Diameter - 3V Lithium Coin Cell Battery](#)





These are the highest quality & capacity batteries, the same as shipped with the iCufflinks, iNecklace, Datalogging and GPS Shields, GPS HAT, etc. One battery per order...



<https://www.adafruit.com/product/380>

You MUST have a coin cell installed for the RTC to work, if there is no coin cell, you should pull the battery pin low.

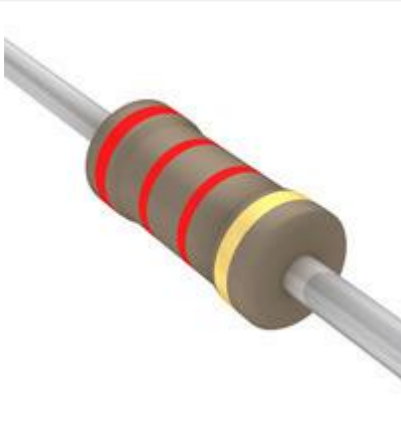
Parts List

If you have the assembled version, skip this step, it's done for you!

| Image | Name | Description | Part Information | Quantity |
|-------------------------------------------------------------------------------------|--------|----------------------------------------------|-------------------------------------------|----------|
|  | IC2 | Real time clock chip | DS1307 | 1 |
|  | Q1 | 32.768 KHz, 12.5 pF watch crystal | Generic 32.768KHz crystal | 1 |
|  | R1, R2 | 1/4W 5% 2.2K resistor Red, Red, Red, Gold | Generic | 2 |
|  | C1 | 0.1uF ceramic capacitor (104) | Generic | 1 |
|  | | 5 pin male header (1x5) | Generic | 1 |

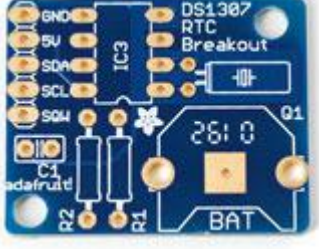
| | | | | |
|------------------------------------------------------------------------------------|-------|----------------------------------------------------------------------------------------------------------------------------------------------------------------------|---------------------|---|
|  | BATT | 12mm 3V lithium coin cell (As of October 15th, 2015, this product no longer comes with a coin cell battery - though we recommend you purchase one!) | CR1220 | 1 |
|  | BATT' | 12mm coin cell holder | Keystone 3001 | 1 |
|  | PCB | Circuit board | Adafruit Industries | 1 |

Assembly

If you have the assembled version, skip this step, it's done for you!

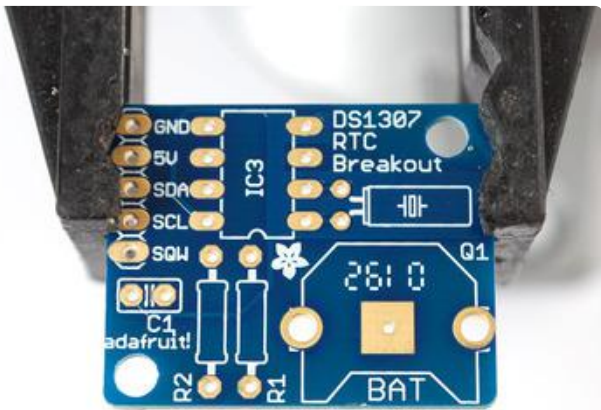

Prepare to assemble the kit by checking the parts list and verifying you have everything!

Next, heat up your soldering iron and clear off your desk.

Place the circuit board in a vise so that you can easily work on it.

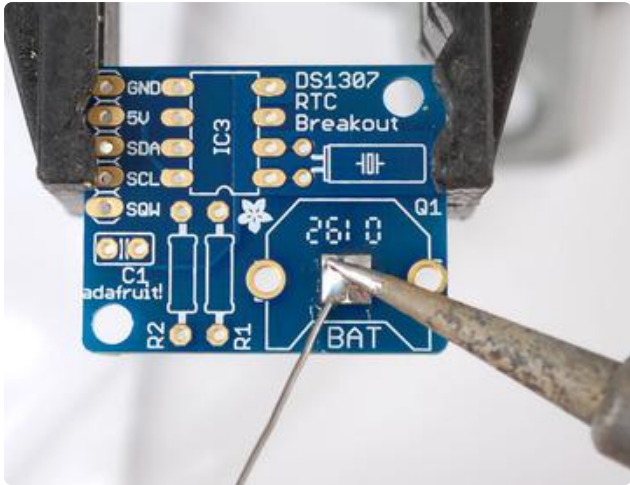

Begin by soldering a small bump onto the negative pad of the battery: this will make better contact!

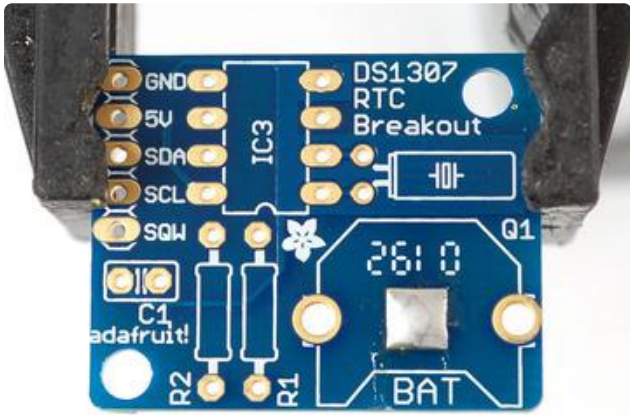

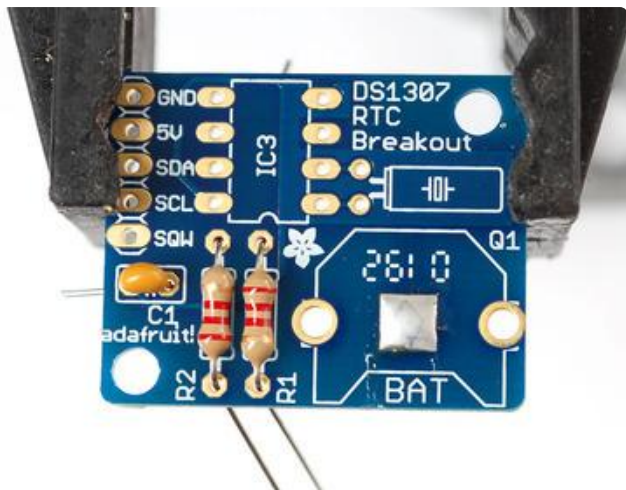

Place the two 2.2K resistors, and the ceramic capacitor. They are symmetric so no need to worry about direction. If you're planning on using with a Raspberry Pi (which has 3.3V logic and built in pull-ups, skip the 2.2K resistors!

Then place the crystal (also symmetric), the battery holder (goes on so that the battery can slip in the side) and the RTC chip.

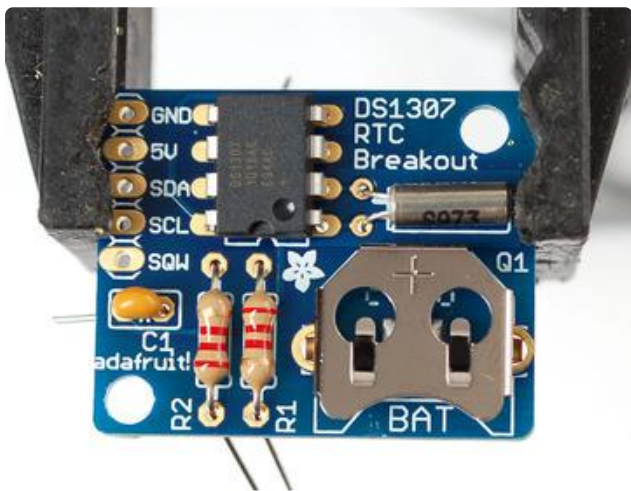

The RTC chip must be placed so that the notch/dot on the end match the silkscreen. Look at the photo on the left, the notch is pointing down. Double check this before soldering in the chip because its quite hard to undo!

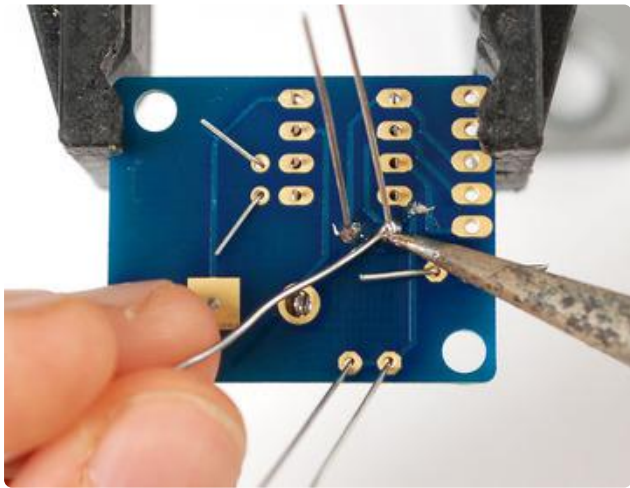
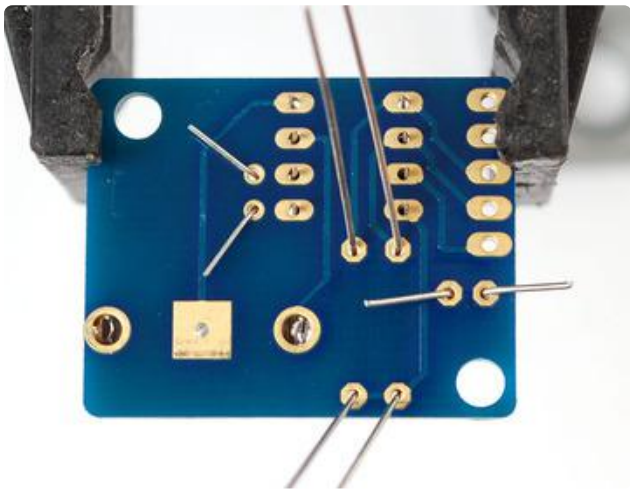

To keep the battery holder from falling out, you may want to 'tack' solder it from the top.

Then flip over the board and solder all the pins.

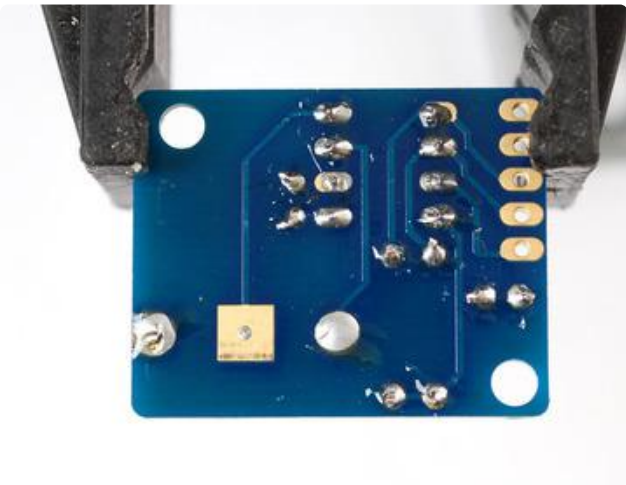
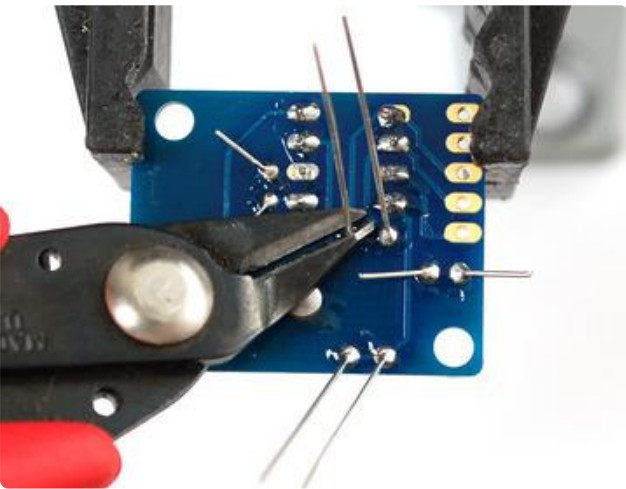
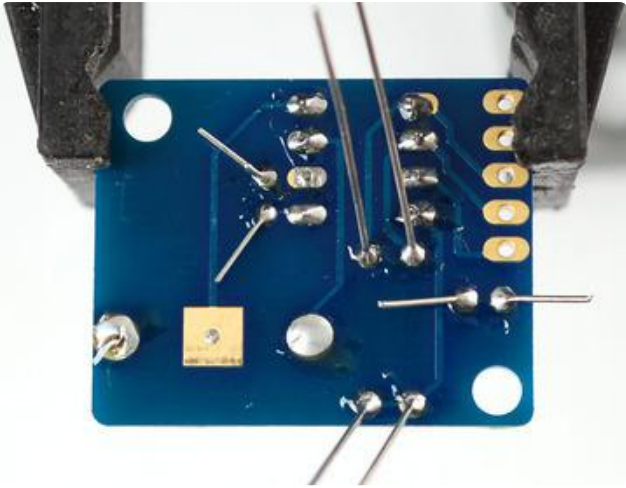

Clip the leads of the resistors, crystal and capacitor short.

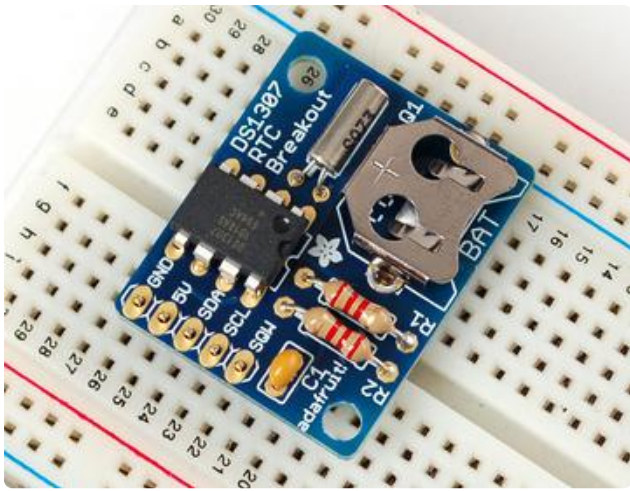

If you'd like to use the header to plug the breakout board into something, place the header in a breadboard, long side down and place the board so that the short pins stick thru the pads.

Solder them in place.

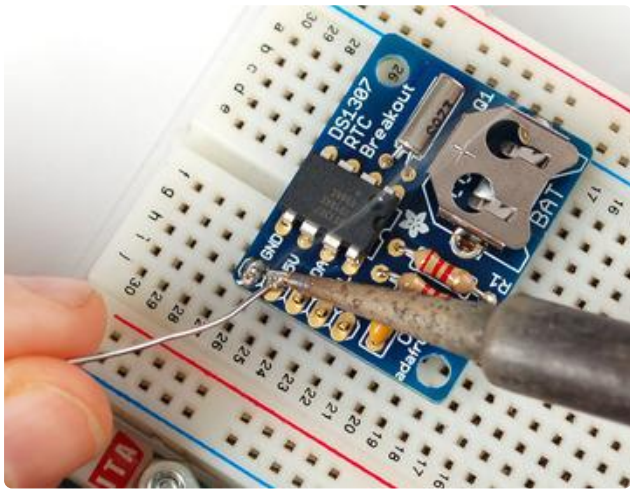

Insert the battery so that the flat + side is UP. The battery will last for many years, 5 or more, so no need to ever remove or replace it.

You **MUST** have a coin cell installed for the RTC to work, if there is no coin cell, it will act strangely and possibly hang the Arduino so **ALWAYS** make SURE there's a battery installed, even if its a dead battery.

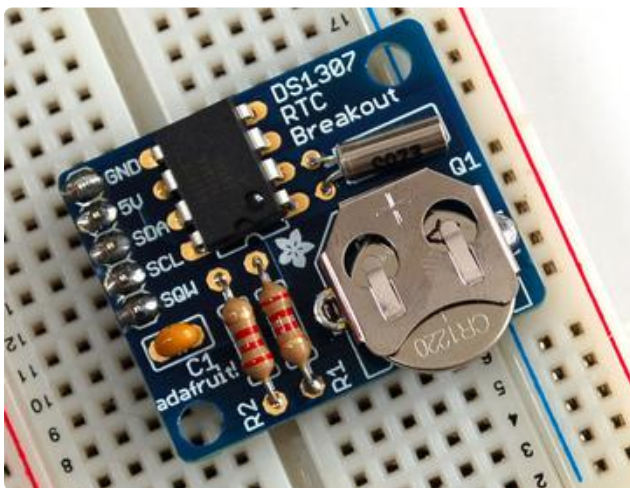

Wiring It Up

There are only 5 pins: 5V GND SCL SDA SQW.

- 5V is used to power to the RTC chip when you want to query it for the time. If there is no 5V signal, the chip goes to sleep using the coin cell for backup.
- Connect GND to common power/data ground

- Connect the SCL pin to the I2C clock SCL pin on your Arduino. On an UNO & '328 based Arduino, this is also known as A5, on a Mega it is also known as digital 21 and on a Leonardo/Micro, digital 3
- Connect the SDA pin to the I2C data SDA pin on your Arduino. On an UNO & '328 based Arduino, this is also known as A4, on a Mega it is also known as digital 20 and on a Leonardo/Micro, digital 2

SQW is the optional square-wave output you can get from the RTC if you have configured it to do so. Most people don't need or use this pin

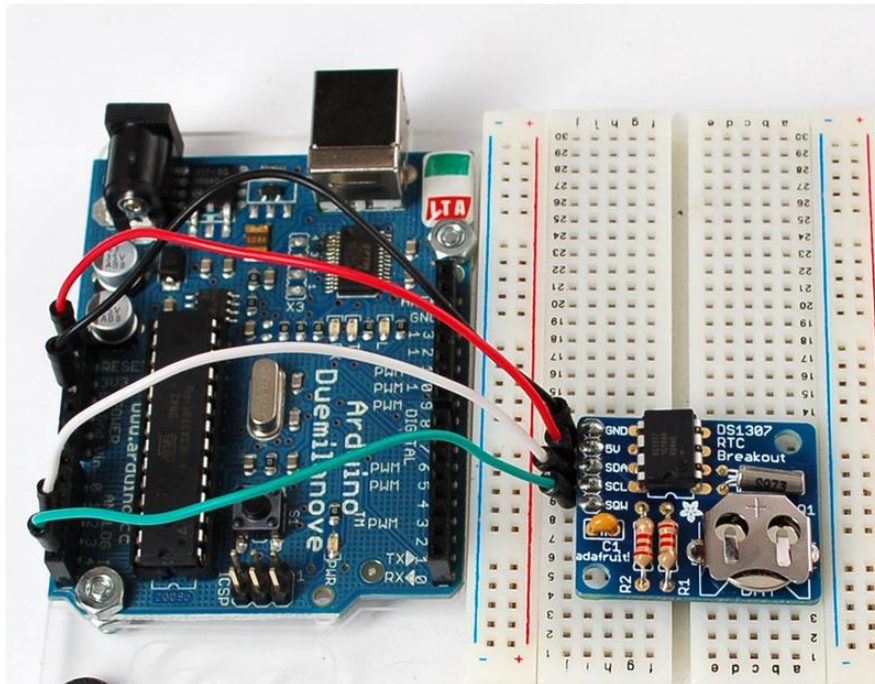

Fun Plug-in Hack for Arduino UNO

If you set analog pin A3 to an OUTPUT and HIGH and A2 to an OUTPUT and LOW you can power the RTC directly from the pins!

Connect Arduino UNO A4 to SDA. Connect Arduino analog pin A5 to SCL.

This only works on an UNO and other ATmega328-based Arduinos!

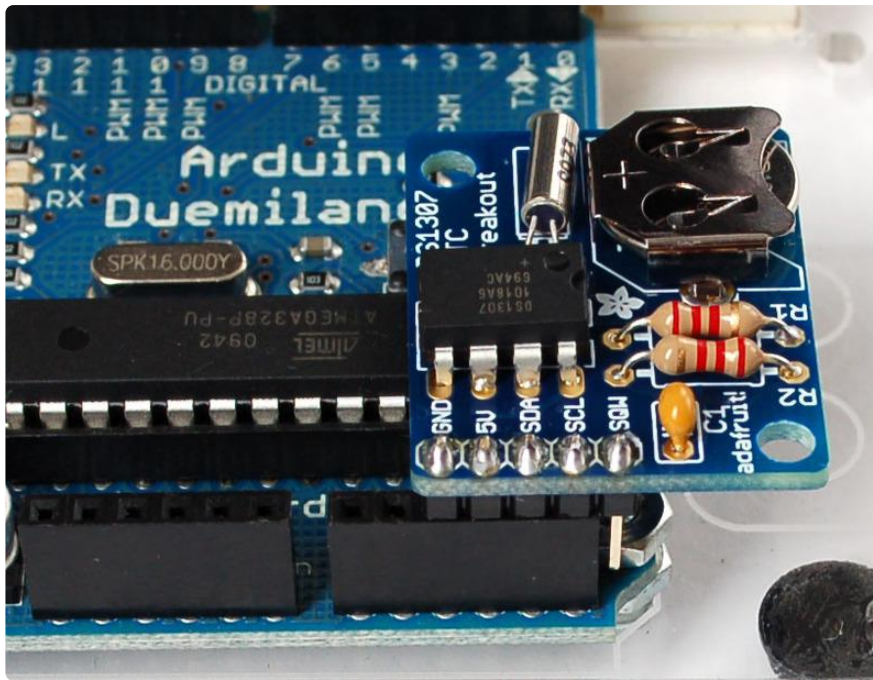

Arduino Library

Talking to the RTC

The RTC is an i2c device, which means it uses 2 wires to communicate. These two wires are used to set the time and retrieve it. On the Arduino UNO, these pins are also wired to the Analog 4 and 5 pins. This is a bit annoying since of course we want to have up to 6 analog inputs to read data and now we've lost two.

For the RTC library, we'll be using a fork of JeeLab's excellent RTC library, [which is available on GitHub \(\)](#). You can do that by visiting the github repo and manually downloading or, easier, just click this button to download the zip

Install Adafruit_RTCLib library

For the RTC library, we'll be using a fork of JeeLab's excellent RTC library.

To begin reading and writing to the RTC, you will need to [install the Adafruit_RTCLib library \(code on our github repository\) \(\)](#). It is available from the Arduino library manager so we recommend using that.

From the IDE open up the library manager...

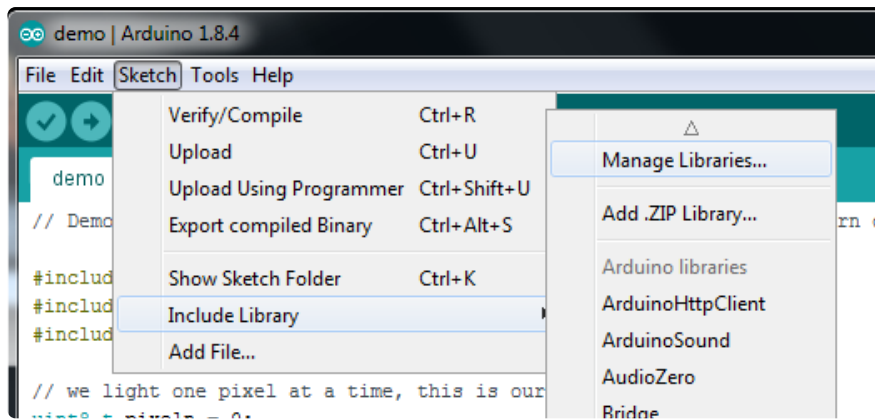

And type in RTCLib to locate the library.

Look for the Adafruit RTCLib (there may be others!)

Click Install



We also have a great tutorial on Arduino library installation at:

<http://learn.adafruit.com/adafruit-all-about-arduino-libraries-install-use>

Once done, restart the IDE

Understanding the Code

First RTC Test

The first thing we'll demonstrate is a test sketch that will read the time from the RTC once a second. We'll also show what happens if you remove the battery and replace it since that causes the RTC to halt. So to start, remove the battery from the holder while the Arduino is not powered or plugged into USB. Wait 3 seconds and then replace the battery. This resets the RTC chip. Now load up the following sketch (which is also found in Examples→RTCLib→ds1307) and upload it to your Arduino with the datalogger shield on!

[\(Don't forget to install the DS1307 library before running the code below\) \(\)](#)

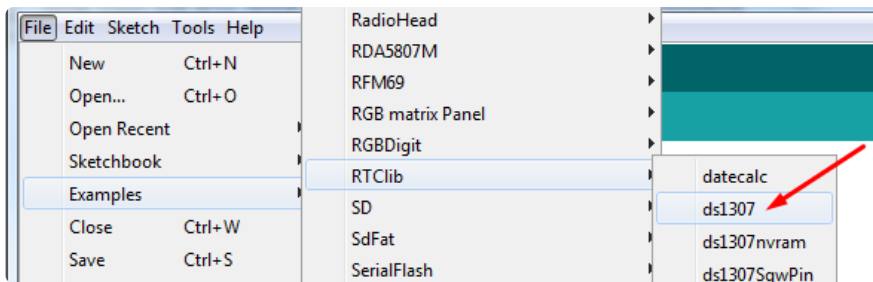

Now open up the Serial Console and make sure the baud rate is set correctly at 57600 baud you should see the following:

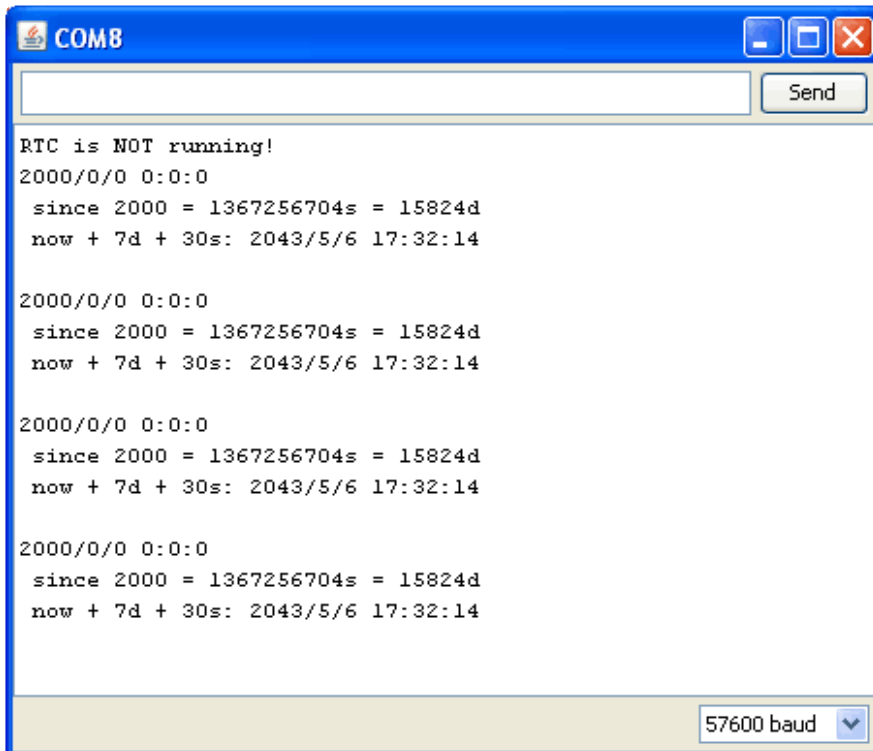

Whenever the RTC chip loses all power (including the backup battery) it will report the time as 0:0:0 and it won't count seconds (its stopped). Whenever you set the time, this will kick start the clock ticking. So basically the upshot here is that you should never ever remove the battery once you've set the time. You shouldn't have to and the battery holder is very snug so unless the board is crushed, the battery won't 'fall out'

Setting the Time

With the same sketch loaded, uncomment the line that starts with RTC.adjust like so:

```

if (! rtc.initialized()) {
  Serial.println("RTC is NOT running!");
  // following line sets the RTC to the date & time this sketch was compiled
  rtc.adjust(DateTime(F(__DATE__), F(__TIME__)));
}
  
```

This line is very cute, what it does is take the Date and Time according the computer you're using (right when you compile the code) and uses that to program the RTC. If your computer time is not set right you should fix that first. Then you must press the U load button to compile and then immediately upload. If you compile and then upload later, the clock will be off by that amount of time.

Then open up the Serial monitor window to show that the time has been set.

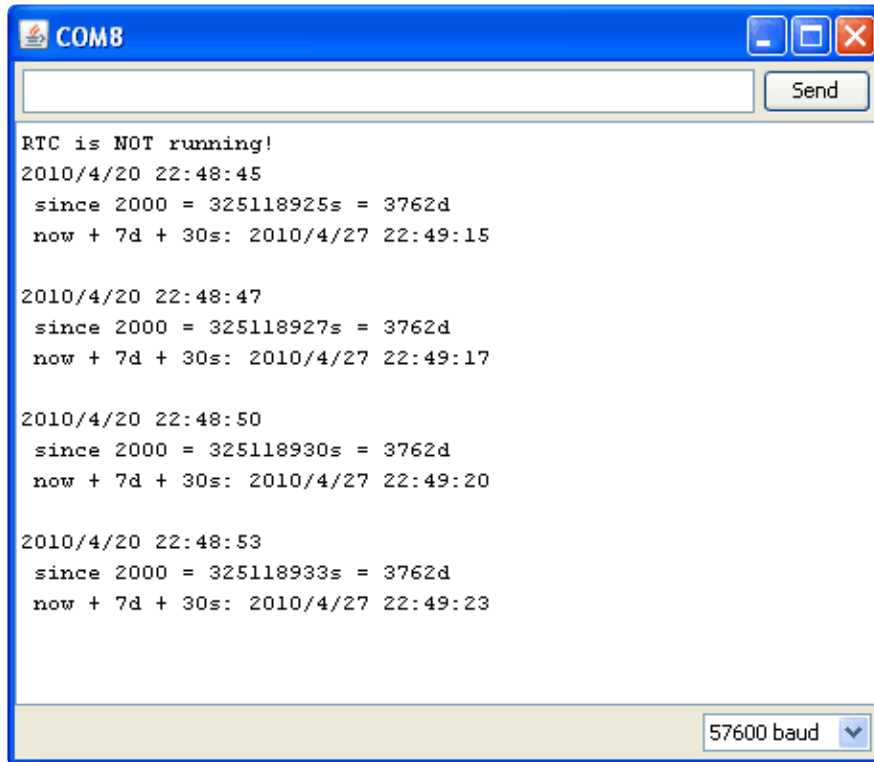

From now on, you wont have to ever set the time again: the battery will last 5 or more years.

Reading the Time

Now that the RTC is merrily ticking away, we'll want to query it for the time. Lets look at the sketch again to see how this is done.

```
void loop () {  
  DateTime now = rtc.now();  
  
  Serial.print(now.year(), DEC);  
  Serial.print('/');  
  Serial.print(now.month(), DEC);  
  Serial.print('/');  
  Serial.print(now.day(), DEC);  
  Serial.print(" ");  
  Serial.print(daysOfTheWeek[now.dayOfTheWeek()]);  
  Serial.print(" ");  
  Serial.print(now.hour(), DEC);  
  Serial.print(':');  
  Serial.print(now.minute(), DEC);  
  Serial.print(':');
```

```
Serial.print(now.second(), DEC);  
Serial.println();
```

There's pretty much only one way to get the time using the RTClib, which is to call `now()`, a function that returns a `DateTime` object that describes the year, month, day, hour, minute and second when you called `now()`.

There are some RTC libraries that instead have you call something like `RTC.year()` and `RTC.hour()` to get the current year and hour. However, there's one problem where if you happen to ask for the minute right at 3:14:59 just before the next minute rolls over, and then the second right after the minute rolls over (so at 3:15:00) you'll see the time as 3:14:00 which is a minute off. If you did it the other way around you could get 3:15:59 - so one minute off in the other direction.

Because this is not an especially unlikely occurrence - particularly if you're querying the time pretty often - we take a 'snapshot' of the time from the RTC all at once and then we can pull it apart into `day()` or `second()` as seen above. It's a tiny bit more effort but we think it's worth it to avoid mistakes!

We can also get a 'timestamp' out of the `DateTime` object by calling `unixtime` which counts the number of seconds (not counting leapseconds) since midnight, January 1st 1970

```
Serial.print(" since 1970 = ");  
Serial.print(now.unixtime());  
Serial.print("s = ");  
Serial.print(now.unixtime() / 86400L);  
Serial.println("d");
```

Since there are $60*60*24 = 86400$ seconds in a day, we can easily count days since then as well. This might be useful when you want to keep track of how much time has passed since the last query, making some math a lot easier (like checking if it's been 5 minutes later, just see if `unixtime()` has increased by 300, you don't have to worry about hour changes).

Downloads

Datasheets & Files

- [EagleCAD PCB files can be found at GitHub \(\)](#)
- [Fritzing object available in the Adafruit Fritzing library \(\)](#)
- [DS1307 product page \(\)](#)

Schematic

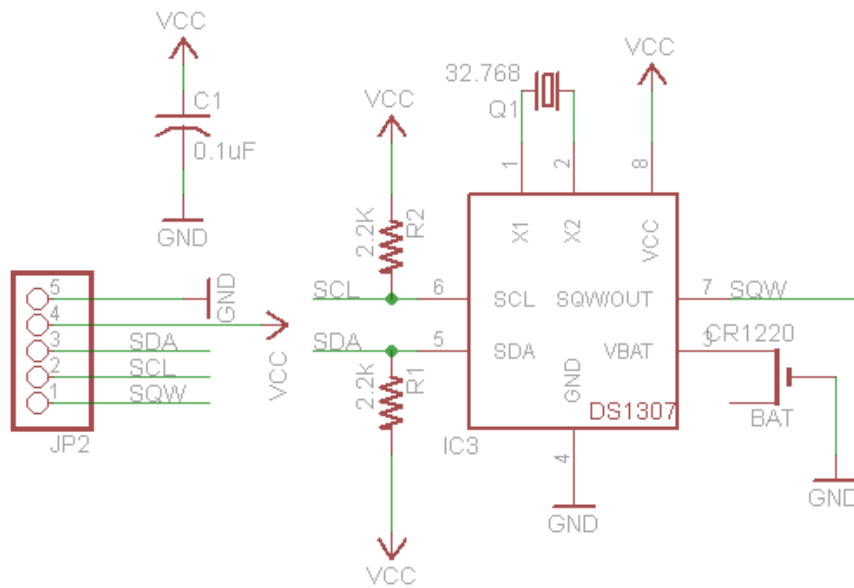

Fabrication Print

