

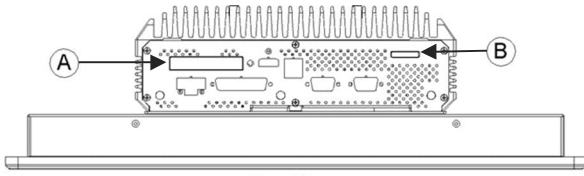

## 19" Fanless Industrial Panel PC with Intel® Core™ i3-7101TE/i5-7500T/i7-7700T Processor

- Choose Your Intel® Processor, Memory, and Storage
- Windows® 10 IoT Enterprise OS Standard
- Wi-Fi Option Available
- Panel or VESA mount
- Integrate with AVEVA™ Edge Software

System	CPU	Intel® Dual Core™ : i3-7101TE @ 3.4GHz Intel® Quad Core™ : i5-7500T @ 2.7GHz i7-7700T @ 2.9GHz
	System Chipset	Intel Q170 Chipset
	System Memory Options	2 x DDR4 260-pin SO-DIMM Non-ECC RAM slots (8, 16, 32 GB total)
I/O Ports	USB	4 x USB 3.0 type A
	Serial	2 x RS-232/422/485 DE-9P, COM1/COM2 (default RS-232) 2 x RS-232 DE-9P, COM3/COM4
	Audio	1 x 3.5 mm Line-in 1 x 3.5 mm Line-out 1 x 3.5 mm Mic-in
	Digital I/O	1x DB25S, 8 in/8 out
	LAN	2 x GbE RJ-45
	Display Interface	1 x DVI-I port (max. 1920 x 1080 pixels)
	Power	3-pin connector header, DC power input
	Power Switch	Momentary Toggle
	Remote Power Switch*	2-pin wire-to-wire connector (2.5mm pitch)
	Storage	Solid State Drive Options**
Expansion	SD Card Slot	N/A
	CFast Card Slot	Yes
Touch Screen	Internal Expansion	Optional Wi-Fi kit (Wi-Fi card and antenna)
	Expansion Slot	N/A
Display	Type	5-Wire Resistive Touch
	Interface	USB
	Display Type	19" TFT SXGA LCD
	Size (W x H)	15.0 x 12.0 inches [381.0 x 304.9 mm]
	Resolution (pixels)	1280 x 1024
	Max. Colors	16.7M
	Luminance (cd/m <sup>2</sup> )	400
	Viewing Angle (H°/V°)	160/160
Electrical	Contrast Ratio	600:1
	Backlight Lifetime (Hours)	50,000
	Input Voltage	9~36 VDC
	Input Current	Typ. 1.71A @ 24VDC; Max 6.25A @ 24VDC
Mechanical	Input Power	Typ. 41 W; Max. 150 W
	Dimensions (W x H x D)	18.54 x 15.59 x 5.16 inches [471 x 396 x 131mm]
	Net Weight	Approx. 19.62 lbs. [8.9kg]
	Panel Cutout Dimensions (W x H)	17.20 x 14.25 inches [437 x 362 mm]
	Mounting	Panel mounting, VESA 100 x 100
Environmental	Construction	Black Steel Chassis, Aluminum Heatsink
	Operating Temperature	32~113°F [0~45°C]
	Storage Temperature	-4~176°F [-20~80°C]
	Relative Humidity	20 to 90% @ 40°C, non-condensing
	Rating	NEMA4, IP65 compliant front panel
Operating System	Certifications	CE / FCC Class A / RoHS
	Microsoft Windows® Options	Microsoft Windows® 10 IoT Enterprise Embedded 2019 LTSC 64-bit (EPKEA) Microsoft Windows® 10 IoT Enterprise 2019 LTSC 64-bit (PKEA) Microsoft Windows® 11 IoT Enterprise Embedded 2022 GAC 64-bit (EPKEA)
Notes	* Maple Systems offers a 6' remote power switch cable (P/N: 7431-0127); contact Maple Systems to purchase. ** Additional SSD options available; contact Maple Systems for details	
Specifications subject to change without notice.		



Top View

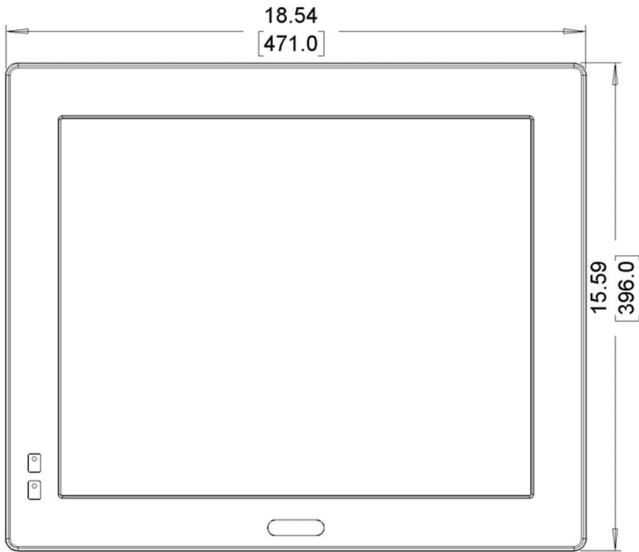

Front View

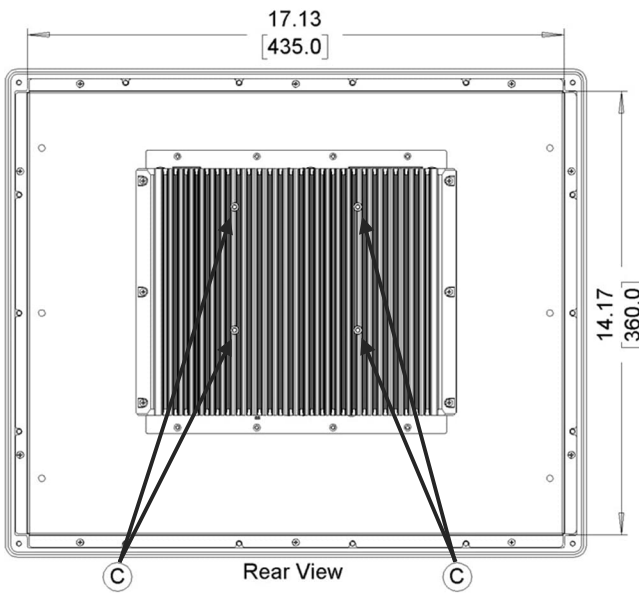

Rear View

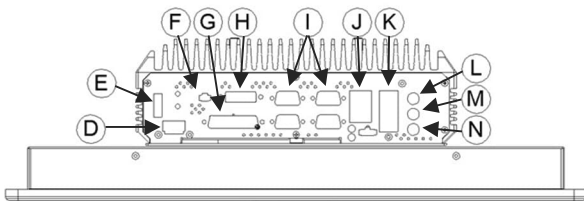

Bottom view

Dimensions are in inches [mm]

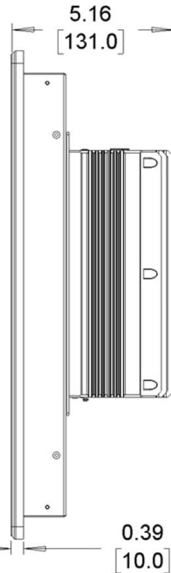

Side View

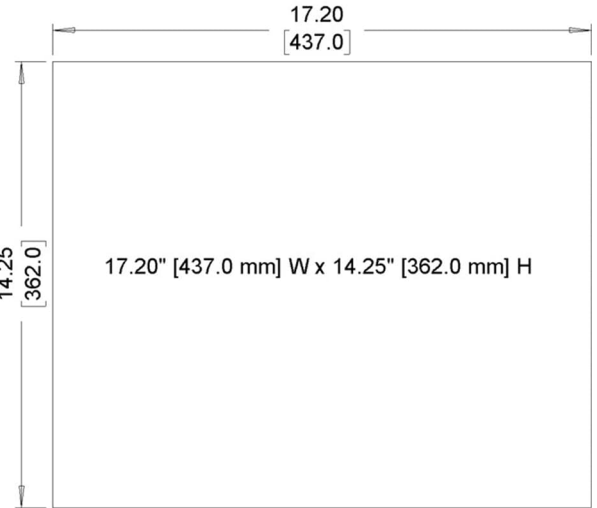

Cutout Dimensions

- |   |                               |   |                        |
|---|-------------------------------|---|------------------------|
| A | CFast Card Slot               | H | DVI-I Output Port      |
| B | SIM Card Slot                 | I | COM Ports DE9P         |
| C | VESA 100mm Screw Holes        | J | Gigabit Ethernet Ports |
| D | Power Connector               | K | USB 3.0 Host Ports     |
| E | Power Switch                  | L | 3.5mm Mic-In Port      |
| F | Remote Power Switch Connector | M | 3.5mm Line-Out Port    |
| G | Digital I/O Port DB25S        | N | 3.5mm Line-In Port     |

# Why Buy A Maple Industrial PC

In addition to our powerful and affordable hardware, we'll also continue to support your company long after a sale. Wide product selection, large in-stock inventory, outstanding product warranty, free technical support and software, and in-house repairs with quick turnaround times, Maple Systems has your business covered.



## Customize To Meet Your Needs

Companies have chosen Maple Systems solutions over Allen-Bradley, Omron, Siemens, Panasonic, and so many others, in hundreds of applications, in every industry, and in every type of organization. Our Industrial PCs are designed to resolve your toughest automation challenges in manufacturing, processing, and fabrication environments, and because we offer thousands of different configurations, designing your IPC to meet your unique requirements is easy.

All our Industrial PCs are ideal for applications in industrial automation, healthcare, manufacturing, oil & gas, packaging, building automation, water, energy, agriculture, food & beverage, and more. Our offerings include [high brightness/sunlight readable displays](#), [extended temperature IPCs](#), [stainless steel enclosures](#), and [Class I, Div 2 certified IPCs](#). Learn more about the [industries we serve](#) and discover why more and more companies are choosing Maple Systems.

## Supports Your 3rd Party Software

Since our Industrial PCs can be configured with either a Windows™ or [Linux™](#) Operating System, adding your own software is easy. Don't be tied to expensive industrial computers or HMIs just because of a name. Our IPCs support FactoryTalk®, Ignition SCADA®, Emerson Ovation®, Simatic SCADA®, Predator Touch HMI®, and hundreds of other HMI and SCADA software solutions.

We are a proud partner of Award-winning AVEVA™ Edge 2020. This powerful HMI/SCADA software package enables you to create custom industrial control applications for your unique industry, putting you in the driver's seat of creating your industrial process. With easy-to-use commands/tool bars and a Microsoft Windows® programming environment, AVEVA™ Edge 2020's feature-rich application puts you in the driver's seat of creating your industrial process. Learn more about [AVEVA Edge 2020](#).

## Build your SCADA

We offer all the components you need to create your own unique level of supervisory data acquisition and control, from the simplest stand-alone machine to sophisticated multi-device networked production line(s), all the way to enterprise-level operations and IIoT functionalities leveraging cloud connectivity.

Our products can help you standardize communications between devices, gluing different systems together for one source to your SCADA. No need to redesign your entire application. Keep the components that are already working for you, just add Maple Systems components to grow your abilities to supervise, control, and acquire data.



[Application Story](#)

## Pharmaceutical Equipment

Adding a Maple Systems [Stainless Steel Industrial Panel PC](#) with Wi Fi to an existing machine saved this OEM time and money

This OEM manufacturer uses a Maple Systems Industrial Panel PC for their production-series tablet pressing machines. The rotary tablet press boasts features essential for successful mid-sized tableting without the full-scale price. This application required a cost effective 12" panel touch screen industrial PC with enough computing power for their custom software and reporting system. They also required the front bezel be stainless steel with a IP69K rating to meet washdown sanitization requirements. See how we support the [Pharmaceutical and Medical Industry](#).

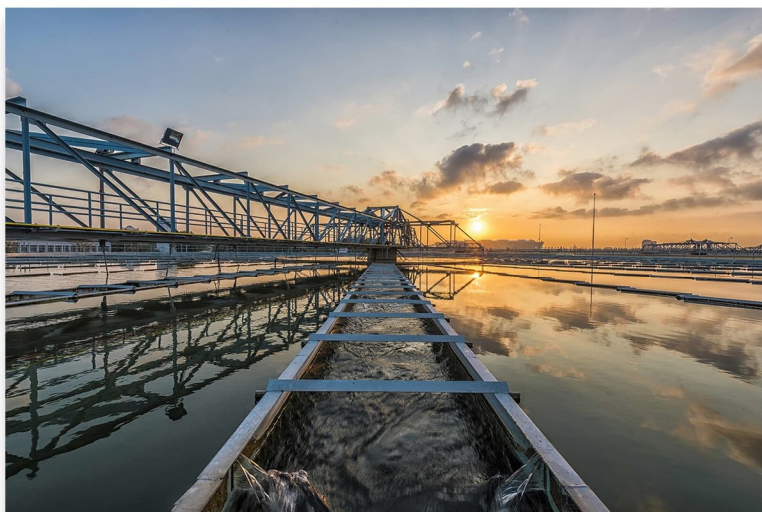

[Case Study](#)

## Water / Wastewater Treatment

Our [High Brightness Industrial Panel PC](#) with Wi-Fi checked all the boxes for this System Integrator

During their large revamping of a utility control system, Aqua Sierra's customer North Tahoe Utilities needed a PC-based HMI to run a simple Wonderware SCADA project as an interface. The PC needed to allow 3rd party software logging and reporting tools for their utility management system. The control room facility is climate controlled with large windows and bright overhead lighting. The remote facility did not have Ethernet cabling out to the PC location, however there was a Wi-Fi router connection nearby. Read how we support the [Water & Wastewater industry](#).

[Application Story](#)

## Dairy / Agriculture Equipment

The [Stainless Steel enclosure](#) makes this Industrial Panel PC the right choice for the food and beverage industry

This customer is a leading OEM manufacturer of custom stainless steel processing equipment and a preferred provider of quality products and services to the cheese, dairy, food, beverage and other sanitary industries. The customer's dairy processing equipment required an IPC that operators can interface with while wearing gloves. Another major requirement is that the PC be IP69K washdown rated to endure the regular cleaning and disinfecting required; and for compliance and record keeping, the customer needed real time data logging and storage using a 3rd party historian application running on the PC. Read more about the [Food & Beverage OEMs](#) we support everyday.

