

SRPE-03E1A0

Non-Isolated DC-DC Converter

The Bel SRPE-03E1A0 is part of the non-isolated DC/DC converter power module series. The modules use a SMD package. These converters are available in a range of output voltages from 0.6 VDC to 5.5 VDC over a wide range of input voltage ($V_{in} = 5.5 - 13.2$ VDC). The efficiency is typically 92% at 3.3 Vout ($V_{in} = 12$ VDC) at full load.



Key Features & Benefits

- 5.5 – 13.2 VDC Input
- 0.6 – 5.5 VDC / 3 A Output
- Non-Isolated
- Wide Output Trim Range
- Fixed Frequency
- High Efficiency
- OCP/SCP
- Wide Input Voltage Range
- Remote On/Off
- Low Cost
- Under-Voltage Lockout
- Class II, Category 2, Non-Isolated DC/DC Converter (refer to IPC-9592B)

Applications

- Networking
- Computers and Peripherals
- Telecommunications

1. MODEL SELECTION

MODEL NUMBER	OUTPUT VOLTAGE	INPUT VOLTAGE	MAX. OUTPUT CURRENT	MAX. OUTPUT POWER	TYPICAL EFFICIENCY
SRPE-03E1A0G SRPE-03E1A0R	0.6 – 5.5 VDC	5.5 - 13.2 VDC	3 A	16.5 W	92%

PART NUMBER EXPLANATION

S	R	PE	-	03	E	1A	0	x
Mounting Type	RoHS Status	Series Name		Output Current	Input Range	Output Voltage	Active Logic	Package Type
Surface Mount	RoHS	SMD SIP		3 A	5.5 - 13.2 V	0.6 - 5.5 V	Active High	G – Tray Package R – Tape and Reel Package

2. ABSOLUTE MAXIMUM RATINGS

PARAMETER	DESCRIPTION	MIN	TYP	MAX	UNITS
Continuous non-operating Input Voltage		-0.3	-	15	V
Output Enable Terminal Voltage		-0.3	-	15	V
Ambient Temperature		0	-	50	°C
Storage Temperature		-55	-	125	°C
Altitude		-	-	2000	m

NOTE: All specifications are typical at 25°C unless otherwise stated. Ratings used beyond the maximum ratings may cause a reliability degradation of the converter or may permanently damage the device.

3. INPUT SPECIFICATIONS

PARAMETER	DESCRIPTION	MIN	TYP	MAX	UNIT
Input Voltage		5.5	-	13.2	V
Input Current (full load)	This power module is not internally fused. An input line fuse must always be used.	-	-	2.6	A
Input Current (no load)		-	10	150	mA
Remote Off Input Current		-	1	5	mA
Input Reflected Ripple Current (pk-pk)	With simulated source impedance of 1000 nH, 5 Hz to 20 MHz. Use a 1000 µF/25 V AL-Cap with ESR = 0.03 ohm max and 2*100 µF/25 V Tan cap with ESR = 0.013 ohm max, at 100 kHz@25°C.	-	15	30	mA
Input Reflected Ripple Current (rms)		-	5	15	mA
I ² t Inrush Current Transient		-	-	1	A ² S
Turn-on Voltage Threshold		4.15	4.2	4.45	V
Turn-off Voltage Threshold		3.7	4	4.2	V

NOTE: All specifications are typical at 25 °C unless otherwise stated

4. OUTPUT SPECIFICATIONS

PARAMETER	DESCRIPTION	MIN	TYP	MAX	UNIT	
Output Voltage Set Point	$V_o, \text{set} \geq 0.9 \text{ VDC}$	-2	-	2	% V_o, set	
	$V_o, \text{set} < 0.9 \text{ VDC}$	-3	-	3	% V_o, set	
Load Regulation	$V_o \geq 3.3 \text{ VDC}$	-1.5	-	1.5	% V_o, set	
	$V_o < 3.3 \text{ VDC}$	-20	-	20	mV	
Line Regulation	$V_o \geq 3.3 \text{ VDC}$	-1.5	-	1.5	% V_o, set	
	$V_o < 3.3 \text{ VDC}$	-15	-	15	mV	
Regulation Over Temperature		-	0.8	-	% V_o, set	
Output Ripple and Noise (pk-pk)	0 - 20 MHz BW, with 360 μF ceramic capacitor at output.	-	20	50	mV	
Output Ripple and Noise (rms)		-	5	20	mV	
Output Current Range		0	-	3	A	
Output DC Current Limit		3.5	4	6	A	
Output Short-Circuit Current ($V_o \leq 20 \text{ mV}$) (Hiccup Mode)		-	-	2	ADC	
Rise Time		-	2	2.5	ms	
Turn On Time		-	3	5	ms	
Overshoot at Turn On		-	0	3.5	%	
Output Capacitance		200	-	1000	μF	
TRANSIENT RESPONSE						
ΔV 50%-100% of Max Load	Overshoot	-	30	60	mV	
	Settling Time	$di/dt = 0.25 \text{ A}/\mu\text{s}$, $V_{in} = 12 \text{ VDC}$, $T_a = 25^\circ\text{C}$, with 360 μF ceramic capacitor at output.	-	20	μs	
ΔV 100%-50% of Max Load	Overshoot		-	30	60	mV
	Settling Time		-	20	50	μs

NOTE: All specifications are typical, at 25°C unless otherwise stated.

5. GENERAL SPECIFICATIONS

PARAMETER	DESCRIPTION	MIN	TYP	MAX	UNIT
Efficiency	$V_o = 5.5 \text{ V}$	92	94	-	%
	$V_o = 3.3 \text{ V}$	90	92	-	
	$V_o = 0.6 \text{ V}$	72	74	-	
Switching Frequency		-	650	-	kHz
Output Voltage Trim Range (Wide Trim)	This voltage is achieved by trimming up output slowly.	0.6	-	5.5	V
Weight		-	2.5	-	g
FIT		-	16.8	-	-
Dimensions (L x W x H)		0.41 x 0.315 x 0.65			inch
		10.41 x 8.0 x 16.51			mm

NOTE: All specifications are typical, at 25°C unless otherwise stated.



Asia-Pacific
+86 755 298 85888

Europe, Middle East
+353 61 225 977

North America
+1 408 785 5200

6. EFFICIENCY DATA

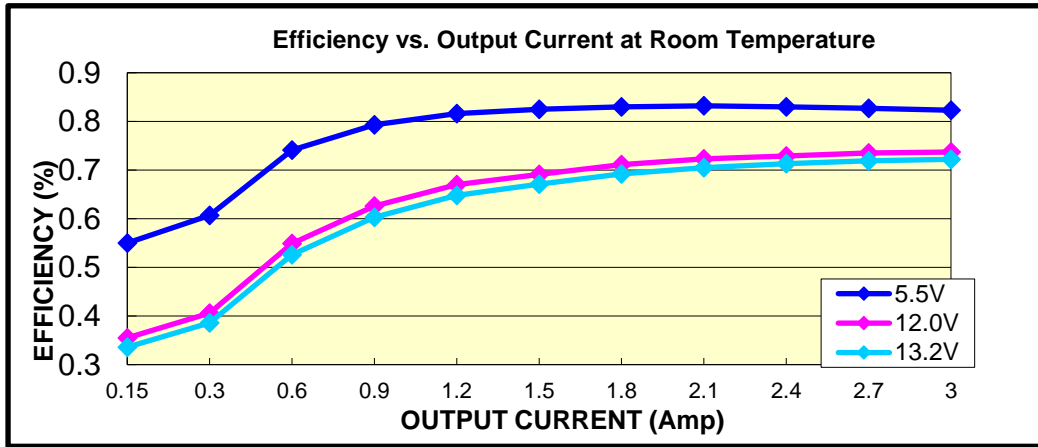

Figure 1. Efficiency data @ Vout: 0.6 V

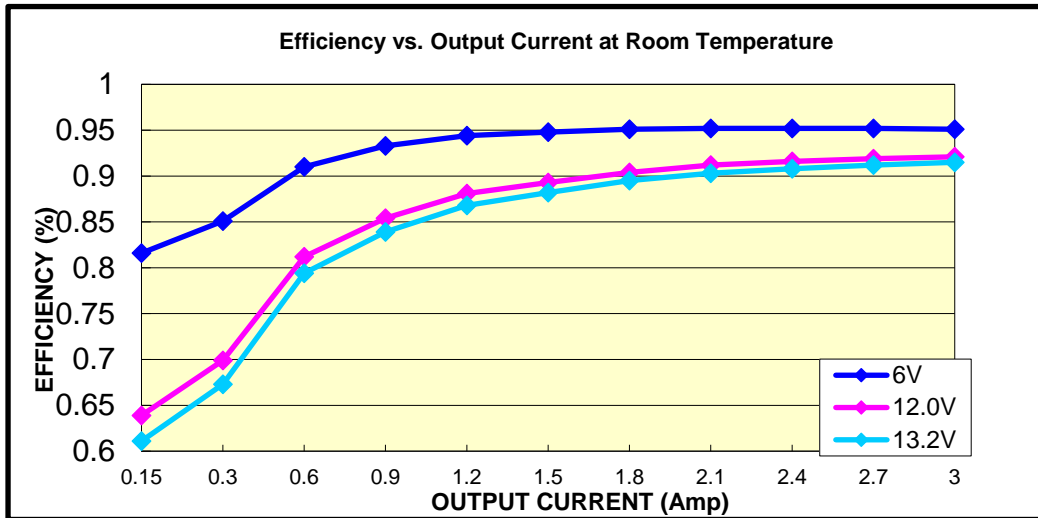

Figure 2. Efficiency data @ Vout: 3.3 V

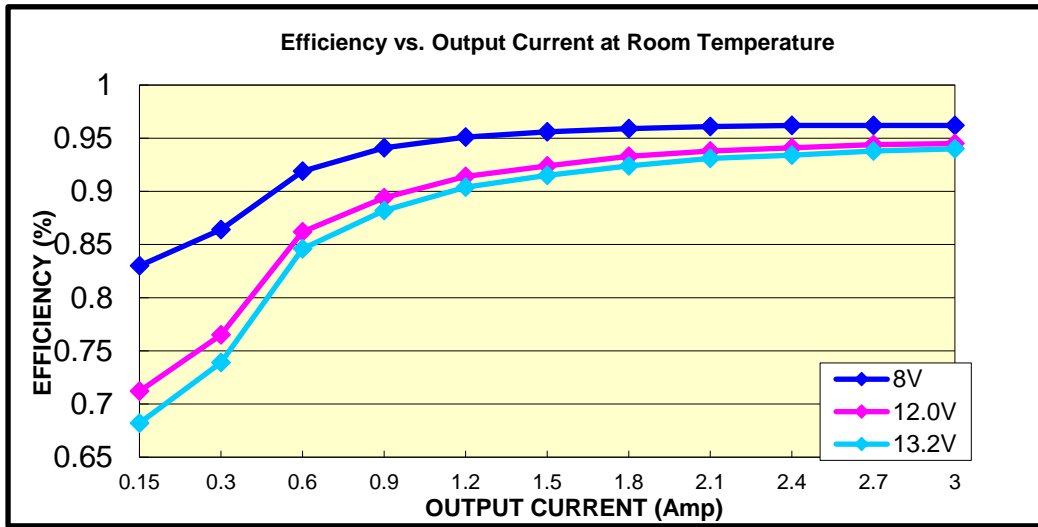

Figure 3. Efficiency data @ Vout: 5.5 V

7. REMOTE ON/OFF

PARAMETER	DESCRIPTION	MIN	TYP	MAX	UNIT
Signal Low (Unit Off)	Active High. Remote On/Off pin open, unit off.	-0.3	-	0.8	V
Signal High (Unit On)		2.4	-	15	V

Recommended remote on/off circuit for active high

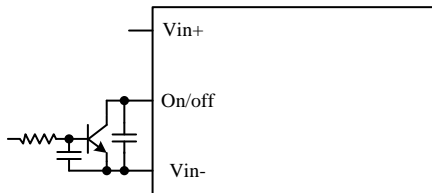

Figure 4. Control with open collector/drain circuit

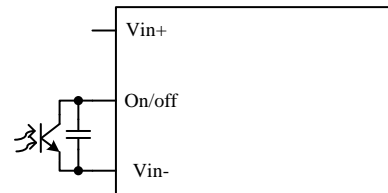

Figure 5. Control with photocoupler circuit

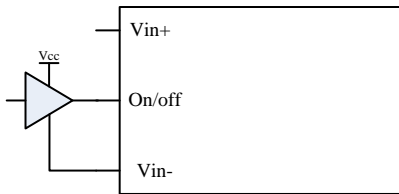

Figure 6. Control with logic circuit

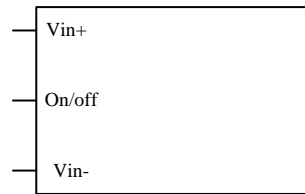

Figure 7. Permanently on

8. RIPPLE AND NOISE WAVEFORM

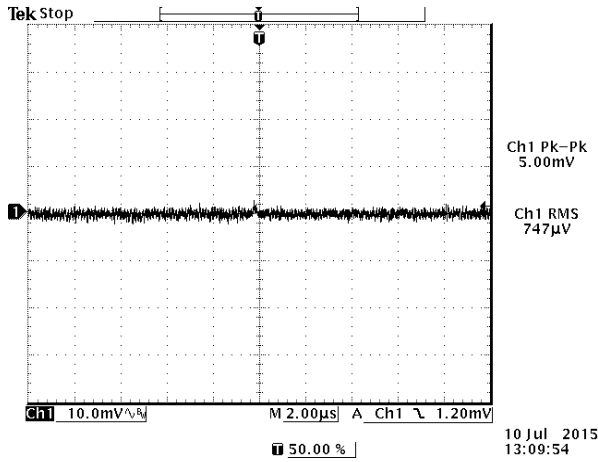

Figure 8. Ripple and noise at full load, 12 VDC input
0.6 VDC output and $T_a = 25^\circ\text{C}$

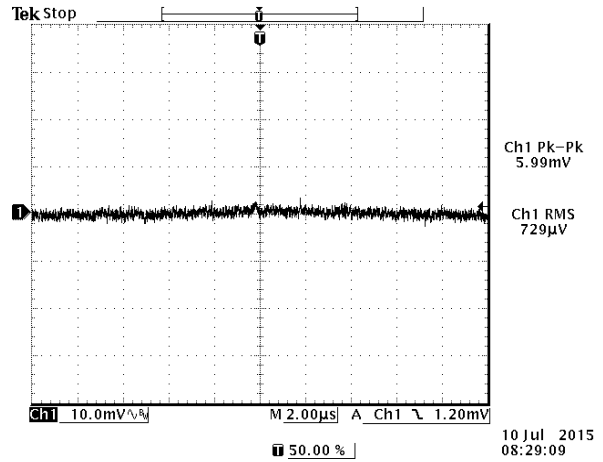

Figure 9. Ripple and noise at full load, 12 VDC input
3.3 VDC output and $T_a = 25^\circ\text{C}$

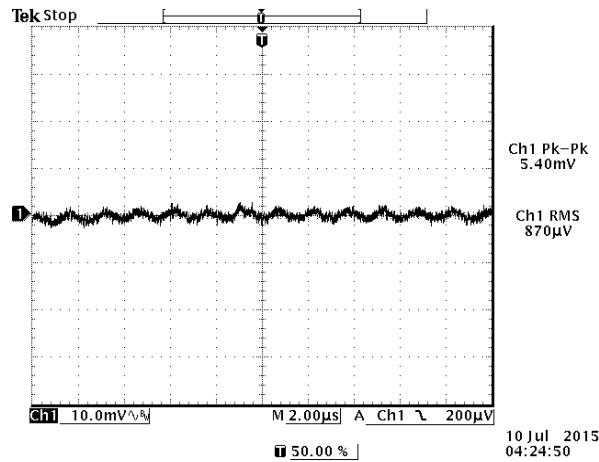

Figure 10. Ripple and noise at full load, 12 VDC input
5.5 VDC output and $T_a = 25^\circ\text{C}$

NOTE: Test condition of the output ripple and noise: 0-20 MHz BW, with 360 µF ceramic cap at output.

9. TRANSIENT RESPONSE WAVEFORMS

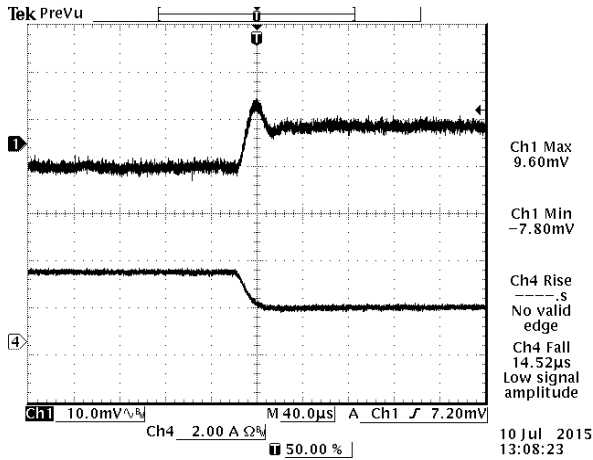

Figure 11. Vin = 100% - 50% Load Transient at Vin = 12 VDC
Vout = 0.6 VDC @ Ta = 25 °C

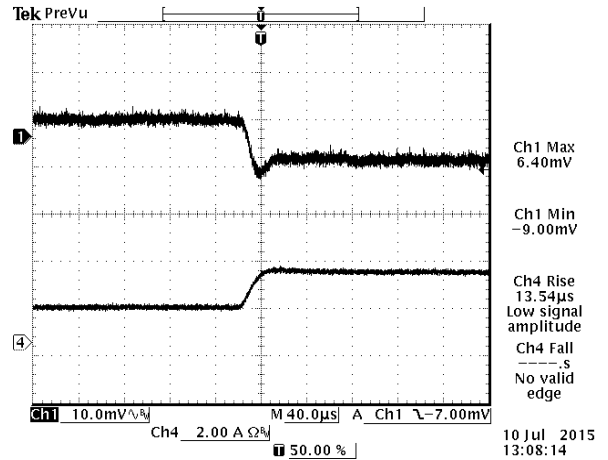

Figure 12. Vin = 50% - 100% Load Transient at Vin = 12 VDC
Vout = 0.6 VDC @ Ta = 25 °C

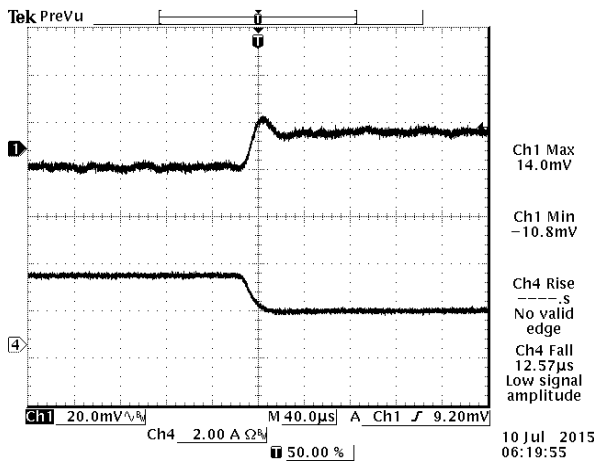

Figure 13. Vin = 100% - 50% Load Transient at Vin = 12 VDC
Vout = 3.3 VDC @ Ta = 25 °C

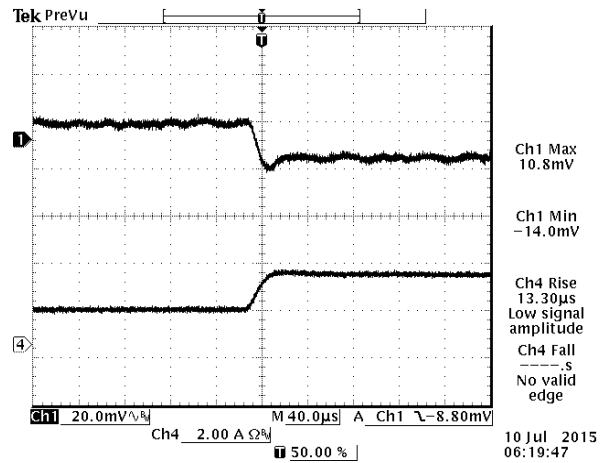

Figure 14. Vin = 50% - 100% Load Transient at Vin = 12 VDC
Vout = 3.3 VDC @ Ta = 25 °C

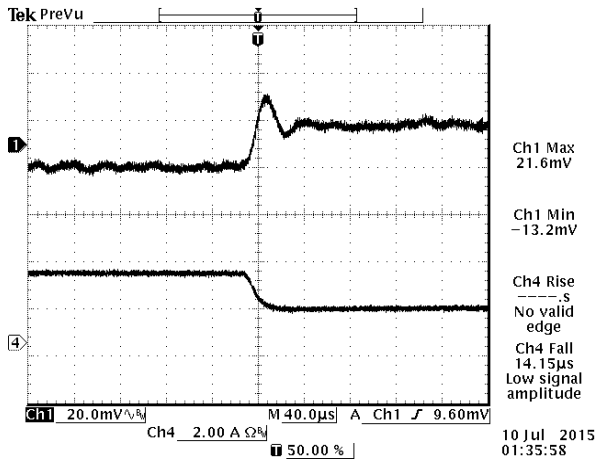

Figure 15. $V_{in} = 100\% - 50\%$ Load Transient at $V_{in} = 12\text{ VDC}$
 $V_{out} = 5.5\text{ VDC}$ @ $T_a = 25\text{ }^\circ\text{C}$

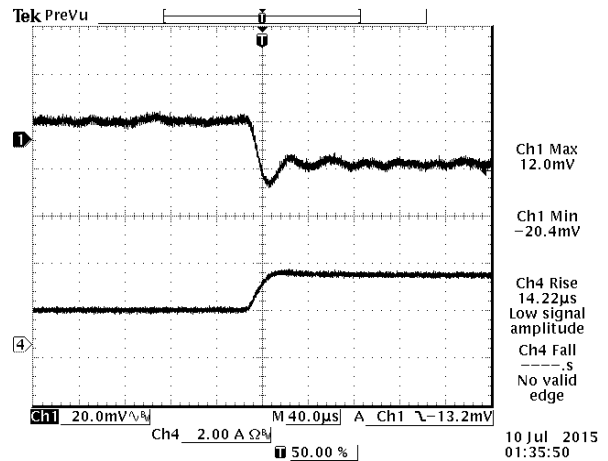

Figure 16. $V_{in}=50\% - 100\%$ Load Transient at $V_{in} = 12\text{ VDC}$
 $V_{out} = 5.5\text{ VDC}$ @ $T_a = 25\text{ }^\circ\text{C}$

NOTE: Test condition of the Transient response: $di/dt = 0.25\text{ A}/\mu\text{s}$, with $360\text{ }\mu\text{F}$ ceramic cap at output.

10. THERMAL DERATING CURVE

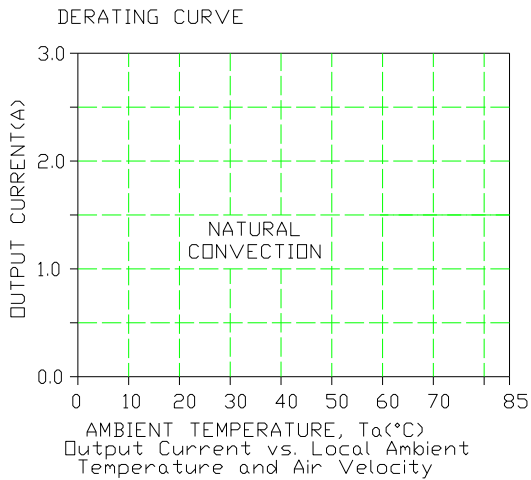

Figure 17. Thermal derating curve @ $V_{in} = 12\text{ V}$, with maximum junction temperature of semiconductors derated to $115\text{ }^\circ\text{C}$

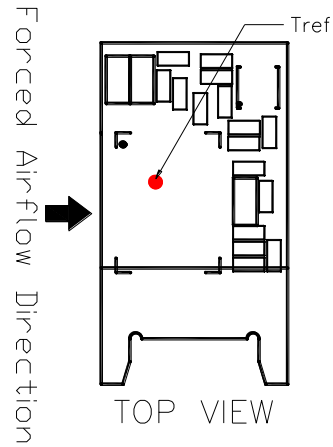

Figure 18. Hot spot and forced airflow direction

11. INPUT UNDER-VOLTAGE LOCKOUT

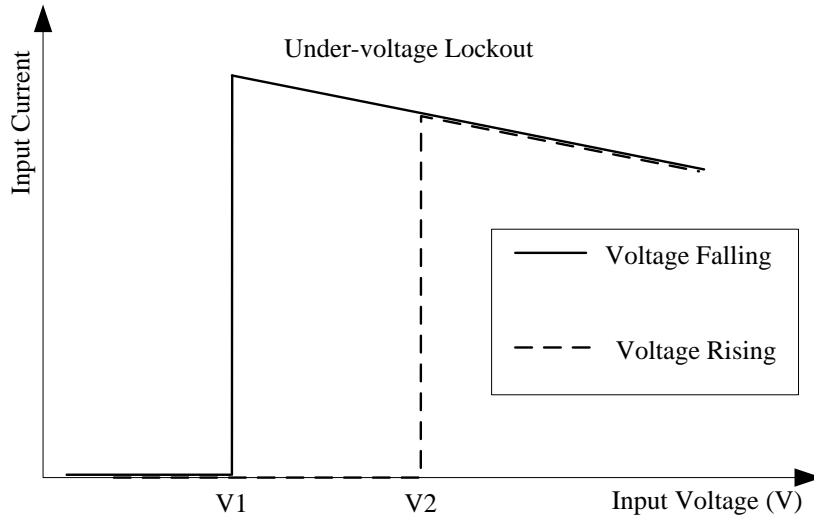

Figure 19. Input under-voltage lockout
 V1 = 4 V
 V2 = 4.2 V

12. TRIM

Trim up circuit (using an external resistor)

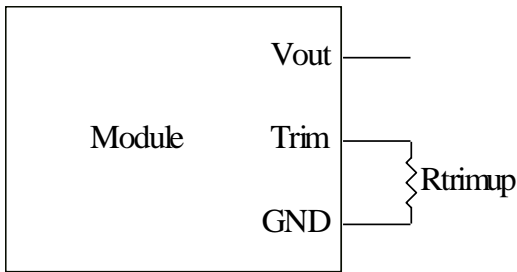

Figure 20. Trim up circuit

SRPE-03E1A0 Trim up Resistor Calculate:

$$R_{trim} = \frac{1.2}{V_o - 0.6} k\Omega$$

V_o is the desired output voltage
R_{trim} is the required resistance between TRIM and GND

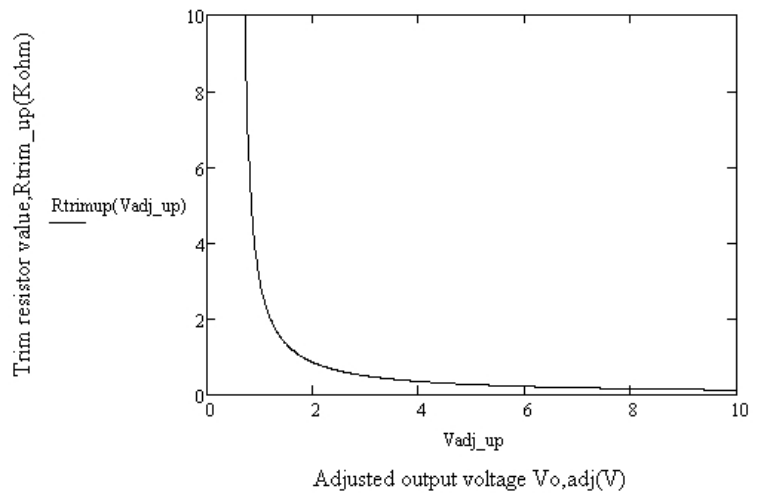

Figure 21. Trim up curve

13. SOLDERING INFORMATION

The SRPE-03E1A0 modules are designed to be compatible with reflow soldering process. The suggested Pb-free solder paste is Sn/Ag/Cu(SAC). The recommended reflow profile using Sn/Ag/Cu solder is shown in the following. Recommended reflow peak temperature is 245°C while the part can withstand peak temperature of 260°C maximum for 10 seconds. This profile should be used only as a guideline. Many other factors influence the success of SMT reflow soldering. Since your production environment may differ, please thoroughly review these guidelines with your process engineers.

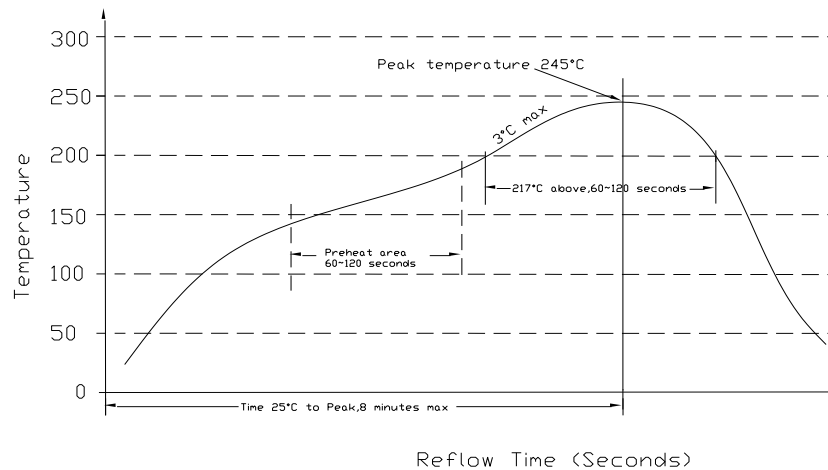

Figure 22. Soldering temperature

14. MSL RATING

The SRPE-03E1A0 modules have a MSL rating of 3.

15. STORAGE AND HANDLING

The SRPE-03E1A0 modules are designed to be compatible with J-STD-033 Rev: A (Handling, Packing, Shipping and Use of Moisture /Reflow Sensitive Surface Mount devices). Moisture barrier bags (MBB) with desiccant are applied. The recommended storage environment and handling procedure is detailed in J-STD-033.

16. PRE-BAKING

This component has been designed, handled, and packaged ready for Pb-free reflow soldering. If the assembly shop follows J-STD-033 guidelines, no pre-bake of this component is required before being reflowed to a PCB. However, if the J-STD-033 guidelines are not followed by the assembler, Bel recommends that the modules should be pre-baked @ 120-125°C for a minimum of 4 hours (preferably 24 hours) before reflow soldering.

17. MECHANICAL DIMENSIONS
OUTLINE

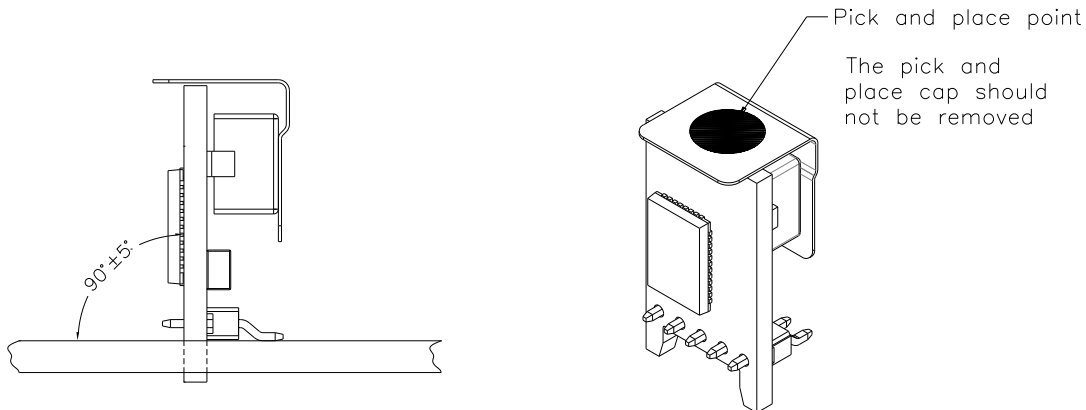
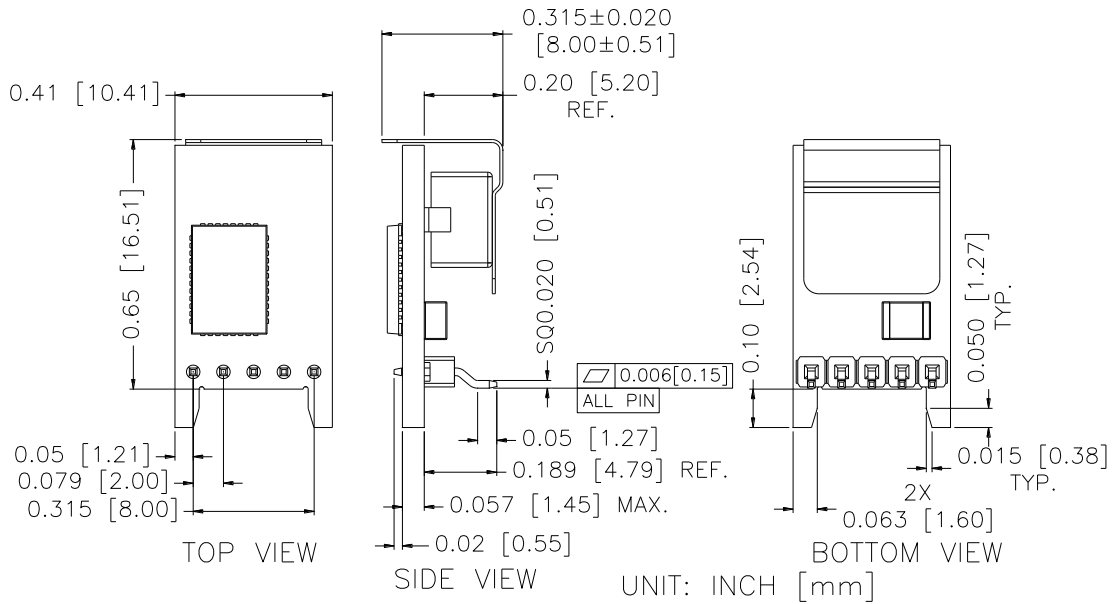

Figure 23. Outline

- NOTE:** 1) All Pins: Material - Copper Alloy;
Finish – 3 micro inches minimum Gold over 50 micro inches minimum Nickel plate
2) Un-dimensioned components are shown for visual reference only.
3) All dimensions in inch [mm]; Tolerances: x.xx +/-0.02 inch [0.51 mm]; x.xxx +/-0.010 inch [0.25 mm].

PIN DEFINITIONS

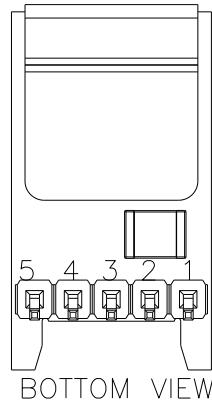

Figure 24. Pins

PIN	FUNCTION
1	Enable
2	Vin
3	GND
4	Vout
5	Trim

RECOMMENDED PAD LAYOUT

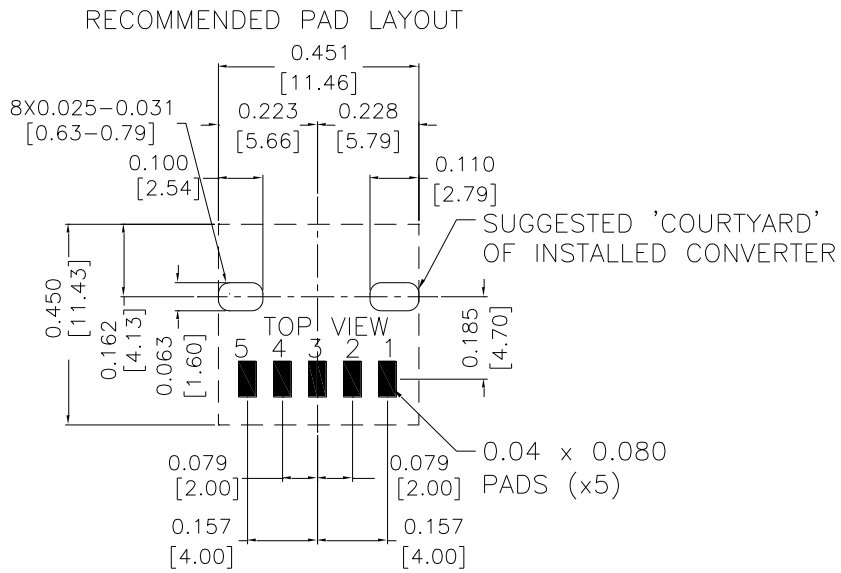

Figure 25. Recommended pad layout

18. REVISION HISTORY

DATE	REVISION	CHANGES DETAIL	APPROVAL
2013-08-20	A	First Release	XF.Jiang
2014-01-14	B	1.Mechanical drawing; 2. Output ripple and noise; 3.Output DC Current Limit; 4.Transient Response; 5.add ROHS logo; 6.Output Voltage Set Point; 7.Load Regulation; 8.Line Regulation; 9.Output DC Current Limit; 10.Efficiency; 11.Turn on/off Voltage Threshold; 11.Update on/off description, add a note for UVLO.	XF.Jiang
2014-04-08	C	Update MD.	XF.Jiang
2014-06-24	D	Update MD.	XF.Jiang
2014-07-03	E	Update part number explanation, RoHS compliance, Add MD Note.	XF.Jiang
2014-11-05	F	Update MD.	XF.Jiang
2014-11-18	G	Update General Specifications, TD, MD.	XF.Jiang
2015-11-17	H	Update Input Specs, Output Specs, General, Efficiency Data, NR, TR, MD.	XF.Jiang
2015-12-22	I	Update Output Specs.	XF.Jiang
2016-05-12	J	Update Thermal Derating Curves.	XF.Jiang
2018-03-14	AK	Update the form.	F.Tao
2020-08-06	AL	Update mechanical outline	XF.Jiang
2021-06-28	AM	Add object ID.	XF.Jiang

For more information on these products consult: tech.support@psbel.com

NUCLEAR AND MEDICAL APPLICATIONS - Products are not designed or intended for use as critical components in life support systems, equipment used in hazardous environments, or nuclear control systems.

TECHNICAL REVISIONS - The appearance of products, including safety agency certifications pictured on labels, may change depending on the date manufactured. Specifications are subject to change without notice.



Asia-Pacific
+86 755 298 85888

Europe, Middle East
+353 61 225 977

North America
+1 408 785 5200