

## 400 Watt

- 400 Watts Forced Cooled
- Efficiency up to 90%
- -40 to 70 degree operating temperature
- High power density : 23.70W/inch<sup>3</sup>
- Thermal Shut-Down feature / Dual fusing
- 2.56m Hours, Telcordia -SR332-issue 3 MTBF



The New FLS400 Series is designed to work with Forced air cooling. This is a highly efficient power supply that can deliver up to 400 W with air. This new series comes with two options. ie. Casing with Side Fan and Top Fan.

### 400 Watts

Model Number	Description	Voltage	Max. Load	Min. Load	Ripple <sup>1</sup>
FLS400-1312	with JST Connector	12V	25A	0.0A	5%
FLS400-1315	with JST Connector	15V	20A	0.0A	5%
FLS400-1324	with JST Connector	24V	16.70A	0.0A	2%
FLS400-1330	with JST Connector	30V	13.30A	0.0A	2%
FLS400-1348	with JST Connector	48V	8.30A	0.0A	2%
FLS400-1358	with JST Connector	58V	6.90A	0.0A	2%

For Top FAN version add "TF" Ex. FLS400-1324-TF

For Side FAN version add "SF" Ex. FLS400-1324-SF

### Pin Connection

J1 (Input)	PIN 1	AC LINE
	PIN 2	NOT FITTED
	PIN 3	AC NEUTRAL
J2 (Output)	PIN 1,2,3	V1 +VE
	PIN 4,5,6	V1 -VE
Self clinching nut		Earth
(J9) Signal Connector	PIN 1	+VS (Remote Sense)
	PIN 2	-VS (Remote Sense)

### Notes

1. Ripple is peak to peak with 20 MHz bandwidth and 10  $\mu$ F (Tantalum capacitor) in parallel with a 0.1  $\mu$ F capacitor at rated line voltage and load ranges.
2. Specifications are for nominal input voltage, 25°C unless otherwise stated.
3. 400W with Forced cooling at 115 VAC to 264VAC.
4. Combine Output Power of Main Output, Fan supply should not exceed 400 W.
5. Output ripple can be more than 2 % of the output voltage.

### Input

Characteristic	Minimum	Typical	Maximum	Units	Notes & Conditions
Input Voltage	85		264	VAC	De-rate linearly from 100% at 115VAC to 70% at 85VAC
Input Frequency	47		63	Hz	
Input Current			6.3	A	
Inrush Current			75	A	
Power Factor	exceeds 0.95 at Full Load				

### Output

Characteristic	Minimum	Typical	Maximum	Units	Notes & Conditions
Output Power			400	W	
Hold-up Time		8mS			At 230 VAC
Line Regulation			+/-0.5%		
Load Regulation			+/-0.5%		
Output Voltage Adjustability			+/-3%		
Rise Time		55		ms	
Set Point Tolerance		+/-1%			
Over Current Protection		> 105%			
Over Voltage Protection		110 to 140%			
Transient Response		25% step load change, at 0.1A/ $\mu$ S slew rate, 50% duty cycle, 50Hz=4% , recovery time < 5 ms			

### General

Characteristic	Minimum	Typical	Maximum	Units	Notes & Conditions
Efficiency		90%			At 230 VAC
Mean Time Between Failure	2.56m Hours				Telcordia -SR332-issue 3
Isolation: Input to Output		4000		VDC	ITAV
Input to Ground		2500			
Leakage Current		300 $\mu$ A Typical			

## Efficiency Vs Load

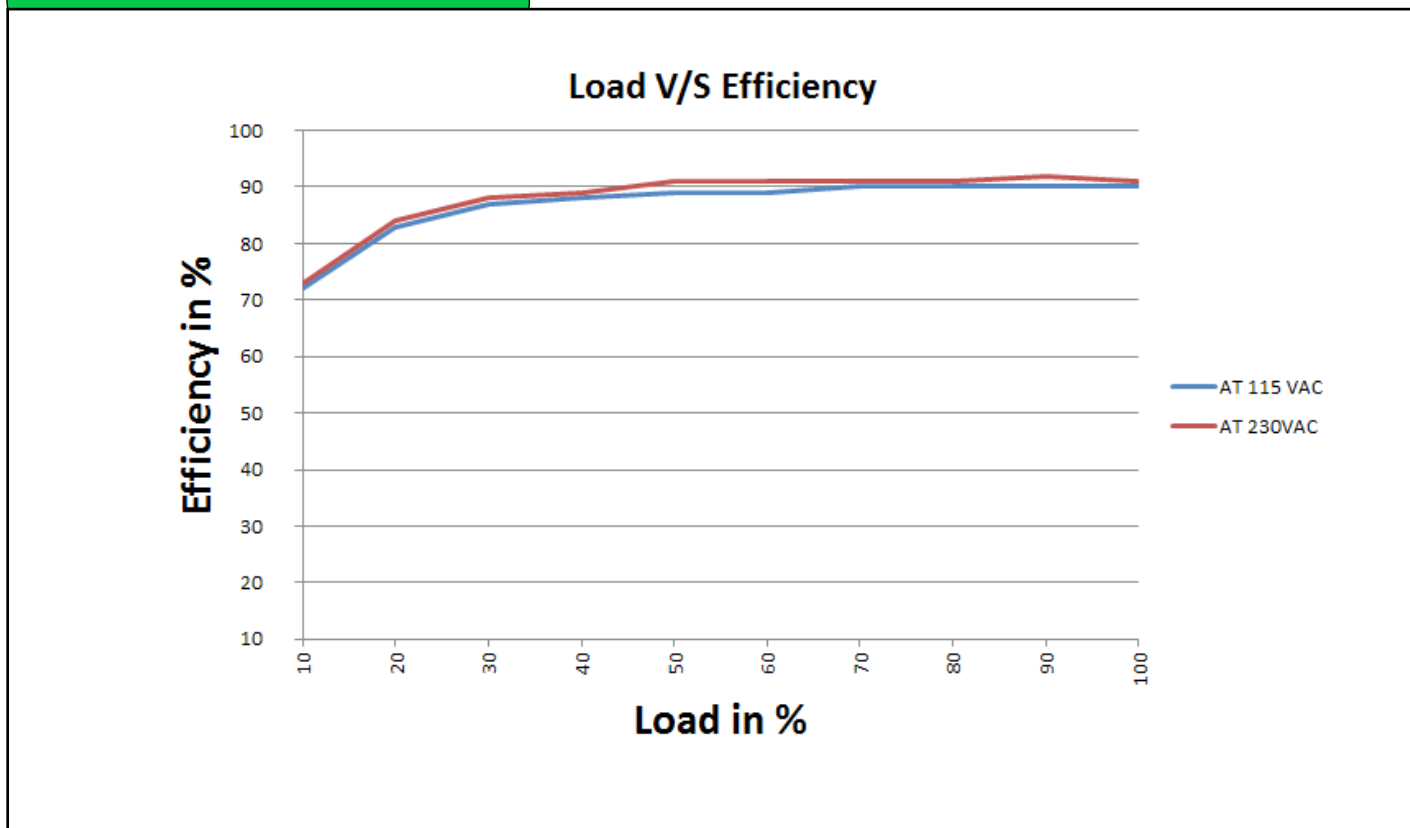

## Environmental

Characteristic	Minimum	Typical	Maximum	Units	Notes & Conditions
Operating Temperature	-40		70	°C	-40 to 0 startup is guaranteed with spec deviation. 70°C (Derated)
Storage Temperature	-40		85	°C	
Relative Humidity	5		95	%	RH, non-condensing
Operating Altitude			16,000	ft	
Short Circuit Protection		Hiccup mode			
Switching Frequency		PFC – 70 to 130 KHz ,PWM – 50-80 KHz			
Cooling					Inbuilt Fans for cooling

### Mechanical Specifications

AC Input Connector (J1)	TE Connectivity: 647676-3 Mating: 1-1123722-3 ; Crimp: 1123721-2	
DC Output Connector (J2)	TE Connectivity: 647676-6 Mating: 1-1123722-6 ; Crimp: 1123721-2	
Earth	Ø4.25 Self clinching nut, (PEM S-M3-0-ZI) or Equivalent	
Dimensions	CK with Top Fan	123.7 x 77.2 x 82.3 approx mm
	CK with Side Fan	135 x 109 x 50 mm
Weight	700 gm approx	

### EMC: Emissions

Phenomenon	Standard	Test Level	Notes & Conditions
Conducted	EN 55032	Level B	CISPR22-B, FCC PART15-B
Radiated	EN 55032	Level A	Level B with external core (King core K5B RC 25x12x15-M or Equivalent in input cable)

### EMC: Immunity

Phenomenon	Standard	Test Level	Criteria	Notes & Conditions
Input Current Harmonics	EN 61000-3-2		Class A	
Voltage Fluctuation and Flicker	EN 61000-3-3			compliance
ESD Immunity	EN 61000-4-2	Level 3	A	
Radiated Field Immunity	EN 61000-4-3	Level 3	A	
Electrical Fast Transient Immunity	EN61000-4-4	Level 3	A	
Surge Immunity	EN 61000-4-5	Level 3	A	
Conducted Immunity	EN61000-4-6	Level 3	A	
Magnetic Field Immunity	EN61000-4-8	Level 3	A	
Voltage dips, interruptions	EN61000-4-11		A & B	

### Safety Approvals

Safety Agency	Safety Standard	Notes & Conditions
CB	IEC 62368-1:2018	ITAV
Nemko	EN 62368-1:2020;A11	
UL	UL62368-1 ED 3.0	
CSA	CAN/CSA C22.2 No. 62368-1:19	
CE Mark	Complies with LVD Directive	

## Derating Curve

### Output Derating v/s Input Voltage

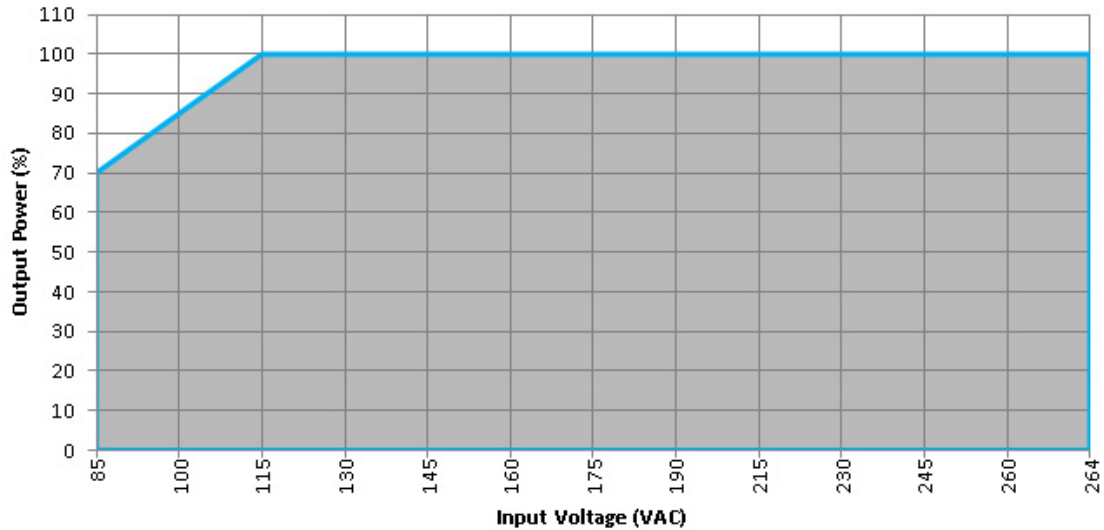

De-rate linearly from 100% at 115VAC to 70% at 85VAC

## Derating Curve

### Power Derating 24V 30V 48V 58V

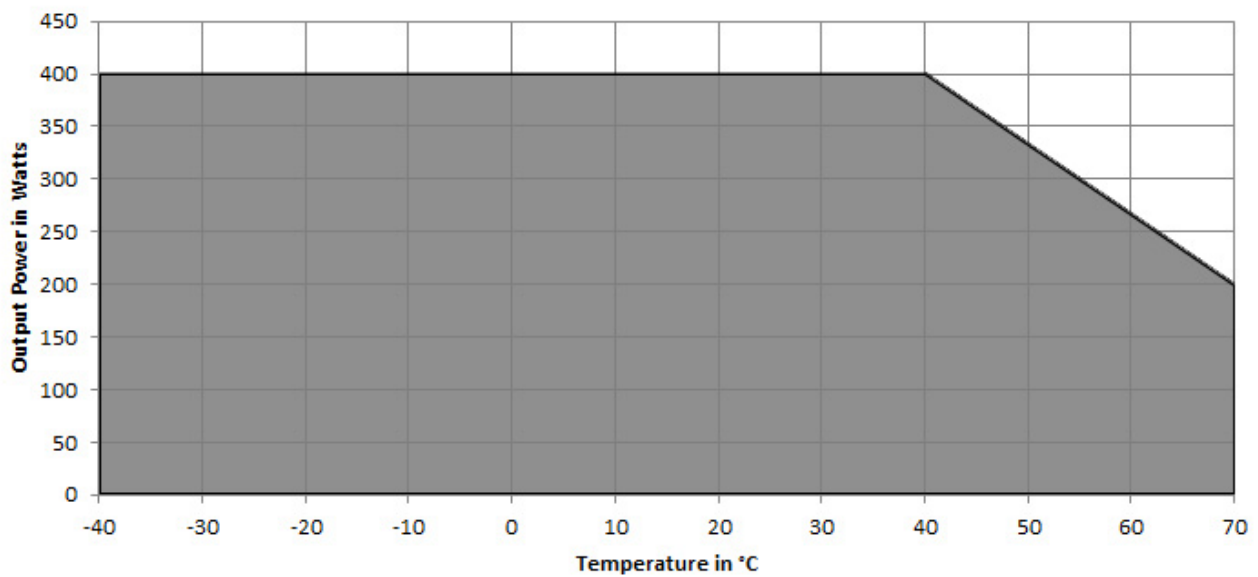

Forced air cooled load: 400W up to 40 °C. De-rate by 1.66% / °C above 40°C till 70°C

## Derating Curve

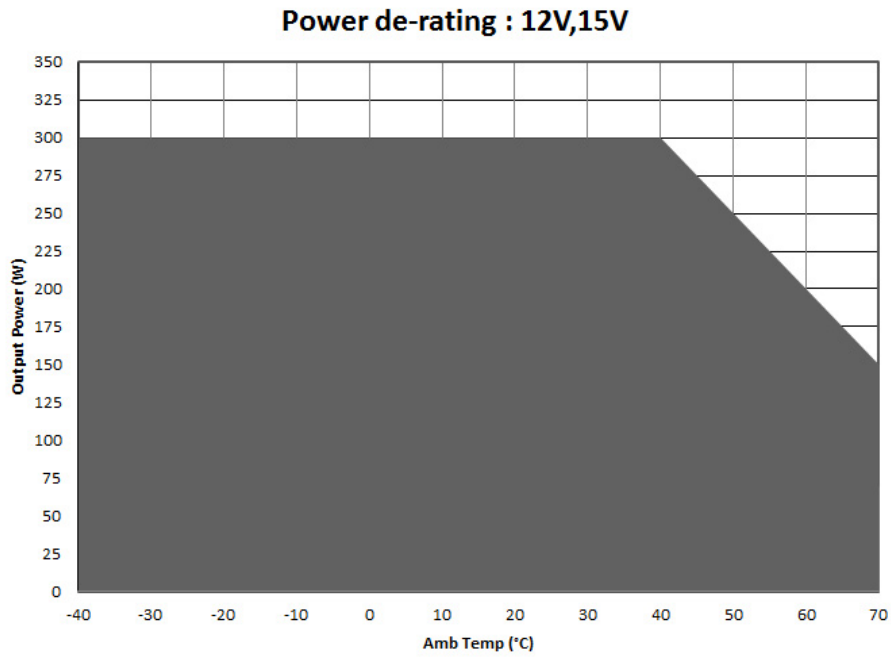

Forced air cooled load: 300W up to 40 °C. De-rate by 1.66% / °C above 40°C

### Mechanical Drawing

### Cover kit with Top FAN

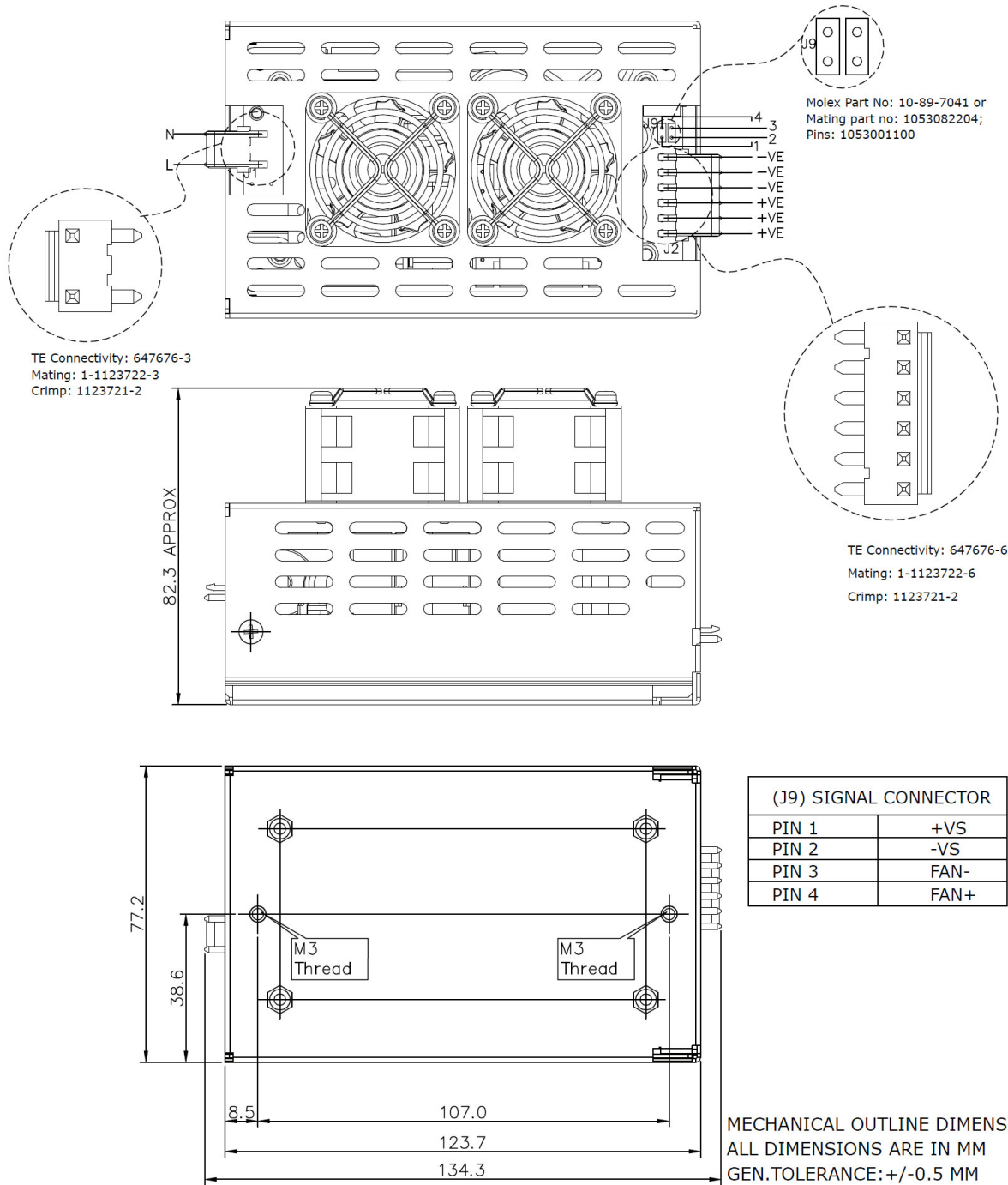

## Mechanical Drawing

### Cover kit with Side FAN

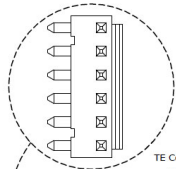

TE Connectivity: 647676-6  
Mating: 1-1123722-6  
Crimp: 1123721-2

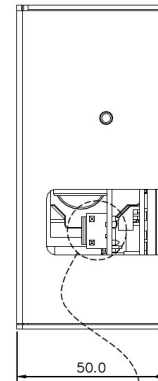
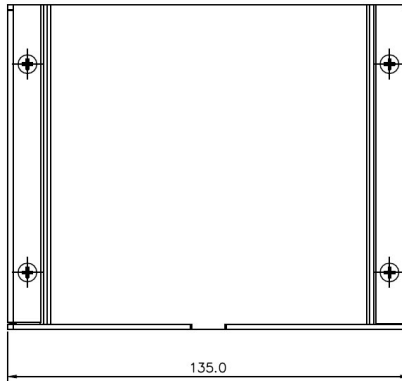
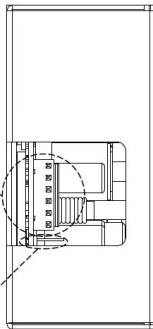
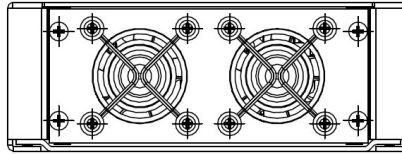

Molex Part No: 10-89-7041 or  
Mating part no: 1053082204;  
Pins: 1053001100

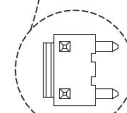
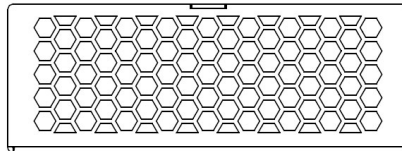

TE Connectivity: 647676-3  
Mating: 1-1123722-3  
Crimp: 1123721-2

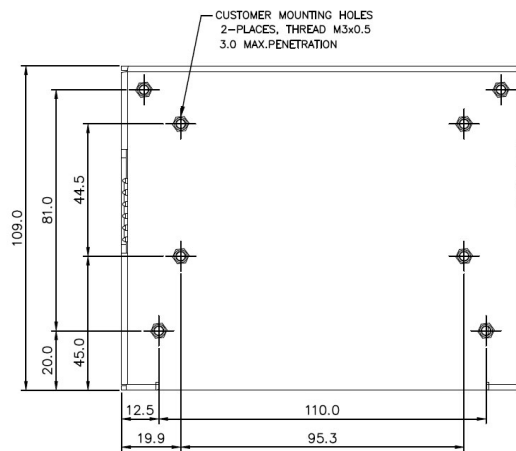

MECHANICAL OUTLINE DIMENSIONS  
ALL DIMENSIONS ARE IN MM  
GEN.TOLERANCE: +/-0.5 MM