

0RQP-X5M12

Isolated DC-DC Converter

The 0RQP-X5M12 series are isolated DC/DC converters that provide up to 1500 W of output power from a nominal 54 VDC input.

These converters are intended to provide isolation and step down to generate a regulated intermediate bus for the purpose of powering non-isolated Point-of-Load (POL) converters.

These converters are provided in 1/4th brick package.



Key Features & Benefits

- 48 – 60 VDC Input
- 12 VDC, 125 A Output
- Isolated
- Fixed Frequency
- High Efficiency
- High Power Density
- Input Under-Voltage Lockout
- OCP/SCP
- Output Over-Voltage Protection
- Over Temperature Protection
- Remote On/Off
- Power Management Bus
- Approved to EN/IEC 62368-1
- Approved to UL/CSA 62368-1
- Class II, Category 2, Isolated DC/DC Converter (refer to IPC-9592B)

Applications

- Networking
- Computers and Peripherals
- Telecommunications

1. MODEL SELECTION

MODEL NUMBER	OUTPUT VOLTAGE	INPUT VOLTAGE	MAX. OUTPUT CURRENT	MAX. OUTPUT POWER	TYPICAL EFFICIENCY
0RQP-X5M12AG					
0RQP-X5M12BG	12 VDC	48 – 60 VDC	125 A	1500 W	97.3%
0RQP-X5M12BAG					

PART NUMBER EXPLANATION

0	R	QP	-	X5	M	12	xxx
Mounting Type	RoHS Status	Series Name		Output Power	Input Range	Output Voltage	Options
Through Hole Mount	RoHS	1/4th Brick		1500 W	48 – 60 V	12 V	AG - Active Low, with Baseplate, Pin Length 0.22". BG - Active Low, with Baseplate, Pin Length 0.145". BAG - Active Low, with Baseplate and Coating, Pin Length 0.145".

2. ABSOLUTE MAXIMUM RATINGS

PARAMETER	DESCRIPTION	MIN	TYP	MAX	UNITS
Input Voltage Continuous	Input over voltage protection will shut down the output voltage when the input voltage exceeds threshold level. See Over-voltage Shutdown Threshold in Input Specification.	-0.3	-	60	V
Remote On/Off		-0.3	-	16	V
Data		-0.3	-	3.3	V
Clock		-0.3	-	3.3	V
Alert		-0.3	-	3.3	V
Addr		-0.3	-	3.3	V
Isolation Voltage		-	-	500	V
Ambient Temperature Long-Term	Long-Term Operating. All components on the Unit meet IPC-9592 (latest revision) derating guidelines. (96 hours/year). Unit's component temperatures exceed IPC-9592 (latest revision) derating guidelines but not exceed component temperature ratings.	-20	-	85	°C
Ambient Temperature Short-Term		-20	-	90	°C
Storage Temperature		-40	-	100	°C
Altitude		-500	-	16404	feet
Humidity		10	85	90	%

NOTE: Ratings used beyond the maximum ratings may cause a reliability degradation of the converter or may permanently damage the device.

3. INPUT SPECIFICATIONS

All specifications are typical at 25°C unless otherwise stated.

PARAMETER	DESCRIPTION	MIN	TYP	MAX	UNIT
Operating Input Voltage		48	54	60	V
Input Current (full load)		-	-	33	A
Input Current (no load)		-	130	170	mA
Remote Off Input Current		-	10	20	mA
Input Reflected Ripple Current (rms)	10 μ H source impedance, $V_{in} = 52 - 60$ V, $I_o = I_{o,max}$. Refer to section 12 for detail input capacitance and waveforms.	-	15	30	mA
Input Reflected Ripple Current (pk-pk)		-	70	100	mA
Input Terminal Ripple Current (rms)		-	1000	1500	mA
Input terminal ripple current over Temperature (rms)	$T_a = -20$ to 85°C	-	3	15	mA
Input Capacitor		260	-	1500	μ F
Input Turn off Voltage Threshold		42.5	44	45	V
Input Turn on Voltage Threshold		46	47	48	V
Over-Voltage Recovery Threshold		60	61	63	V
Over-Voltage Shutdown Threshold	Output shuts down immediately.	64	65	67	V
Recommended input fast-acting fuse on system board	CAUTION: This converter is not internally fused. An input line fuse must be used in application.	45	-	-	A

CAUTION: This converter is not internally fused. An input line fuse must be used in application.

4. OUTPUT SPECIFICATIONS

All specifications are typical at nominal input, full load at 25°C unless otherwise stated.

PARAMETER	DESCRIPTION	MIN	TYP	MAX	UNIT
Output Voltage Set Point	Vin = 54 V, Pout = 725 W	11.88	12	12.12	V
Output Voltage Total Range	Vin = 48 - 60 V, Pout = 0 – 1500 W	11.2	-	12.12	V
Load Regulation	Vin = 54 V, Io = 0~100% load	-	0.01	0.02	V
Line Regulation	Vin = 52 - 60 V, Io = 100% load	-	10	30	mV
Regulation Over Temperature	Vin = 54 V, Io = 100% load, Ta = -20 to 85°C	-	100	-	mV
Ripple and Noise (pk-pk)	Cout = 1470 µF (1000 µF ceramic capacitor + 470 µF POSCAP capacitor)	-	-	150	mV
Ripple and Noise (rms)		-	-	30	mV
Output Ripple and Noise (pk-pk) under worst case	Over entire operating input voltage range, load and ambient temperature condition.	-	-	200	mV
Output Current Range		0	-	125	A
Output DC Current Limit	OCP: Hiccup mode.	130	-	-	A
Peak output power	Power consumption during 10 ms	1560	-	1880	W
Rise Time	Defined as time between Vout at 10% of final value and Vout at 90% of final value.	-	-	20	ms
Turn on Time	Defined as time between Vin reaching Turn-On voltage and Vout reaching 10% of final value.	20	-	30	ms
	Defined as time between Enable and Vout reaching 10% of final value.	-	-	10	ms
Overshoot at Turn on		-	-	3	%
Pre-bias Voltage		-	-	3	V
Output Capacitance	Typically, 50% ceramic, 50% Oscon or POSCAP.	270	1470	10000	µF
Transient Response					
ΔV 50%~75% of Max Load		-	350	-	mV
Settling Time	1 A/µs, 4000 µF capacitors are near the brick output.	-	500	-	µs
ΔV 75%~50% of Max Load		-	350	-	mV
Settling Time		-	500	-	µs

5. OUTPUT PLOT VS INPUT

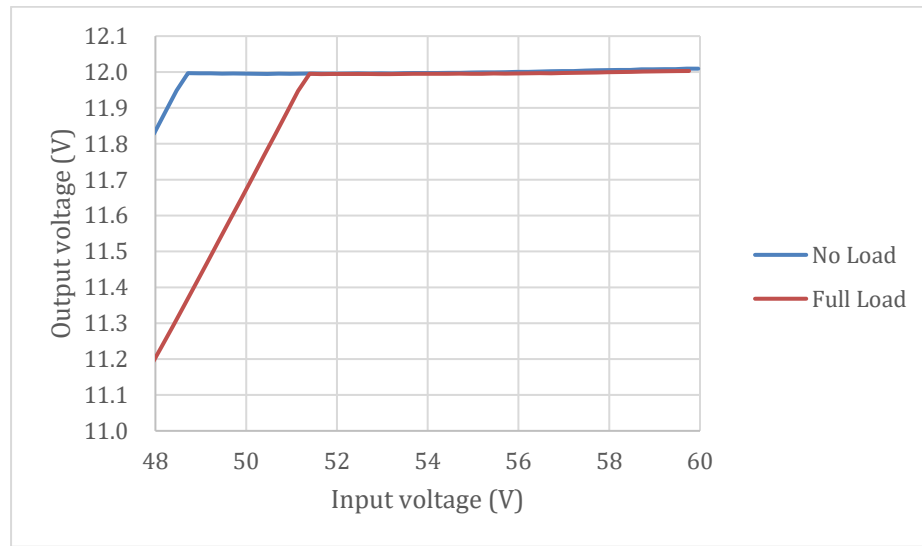

Figure 1. Output plot vs input

6. GENERAL SPECIFICATIONS

PARAMETER	DESCRIPTION	MIN	TYP	MAX	UNIT
Efficiency		-	97.3	-	%
Switching Frequency	Primary FETs	-	150	-	kHz
MTBF	Vin = 54 V, 80% load, 40°C	-	6.96	-	Mhrs
Over Temperature Protection	Auto-recovery.	-	130	-	°C
Output Over Voltage Protection		-	-	15	V
Weight		-	87.4	-	g
Dimensions (L x W x H)		2.30 x 1.45 x 0.57			inch
		58.42 x 36.83 x 14.50			mm
Isolation Characteristics					
Input to Output		-	-	500	V
Input to Case		-	-	500	V
Output to Case		-	-	500	V
Isolation Resistance		10M	-	-	Ohm
Isolation Capacitance		-	1000	-	pF



Asia-Pacific
+86 755 298 85888

Europe, Middle East
+353 61 49 8941

North America
+1 866 513 2839

7. REMOTE ON/OFF

PARAMETER	DESCRIPTION	MIN	TYP	MAX	UNIT
Signal Low (Unit On)	Active Low Remote On/Off pin is open, the module is off.	-0.3	-	0.8	V
Signal High (Unit Off)		2.4	-	16	V
Current (Out of pin)	Module On, On/Off Pin Voltage = -0.3 to 0.8 V	-	-	200	μA
	Module Off, On/Off Pin Voltage = 2.4 V	10	-	-	μA
Current (Into pin)	On/Off pin is pulled up externally to 10 V.	-	-	300	μA
	On/Off pin is pulled up externally to 15 V.	-	-	500	μA
Open circuit voltage		-	-	15	V

Recommended remote on/off circuit for active low

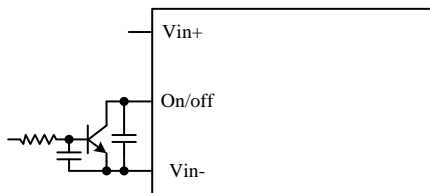

Figure 2. Control with open collector/drain circuit

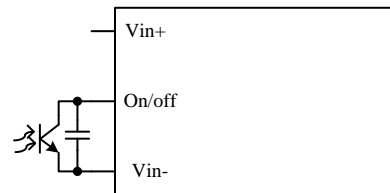

Figure 3. Control with photocoupler circuit

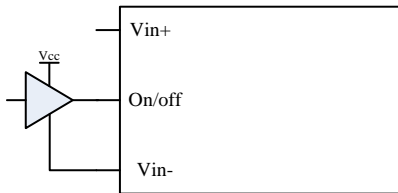

Figure 4. Control with logic circuit

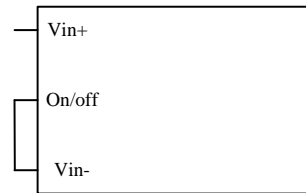

Figure 5. Permanently on

8. EFFICIENCY DATA

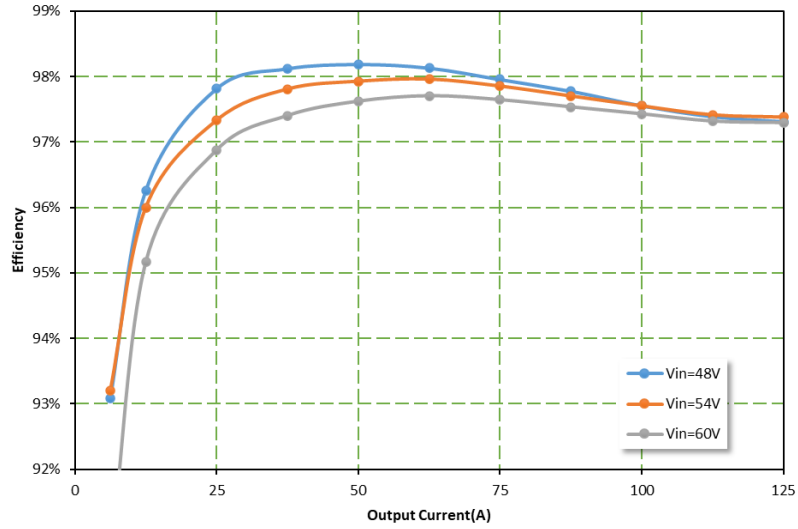

Figure 6. Efficiency vs Output Current

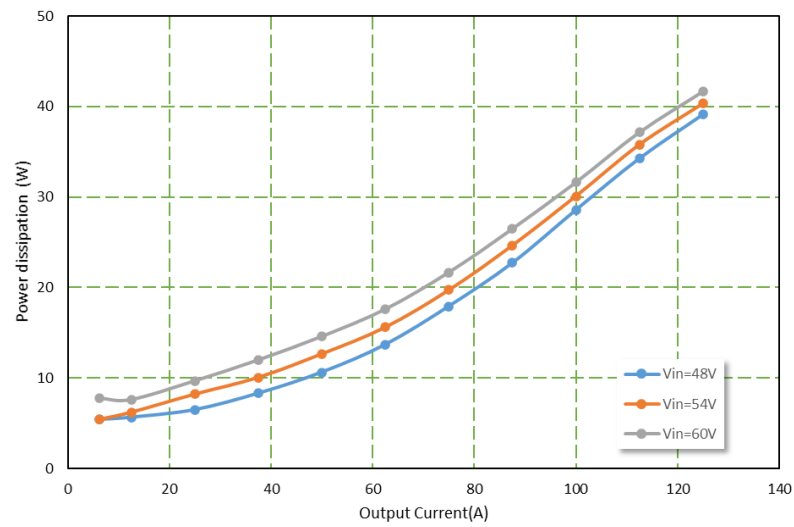

Figure 7. Output Current vs Power Dissipation

Note: The efficiency is measured at Ta = 25°C.

9. INPUT NOISE

Input reflected ripple current

Testing setup

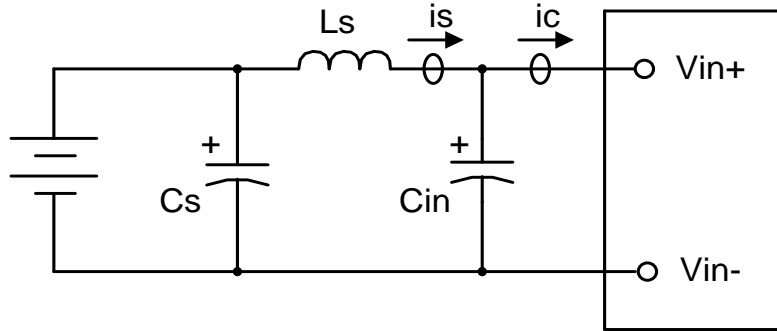

Figure 8. Input reflected ripple current

Notes and values in testing.

is: Input Reflected Ripple Current

ic: Input Terminal Ripple Current

Ls: Simulated Source Impedance (10 μ H)

Cs: Offset possible source impedance (100 μ F, ESR < 0.2 Ω @ 100 kHz, 20°C)

Cin: Electrolytic capacitor, should be as close as possible to the power module to damp ic ripple current and enhance stability.

Recommendation: 330 μ F, ESR < 0.2 Ω @ 100 kHz, 20°C.

Below measured waveforms are based on above simulated and recommended inductance and capacitance.

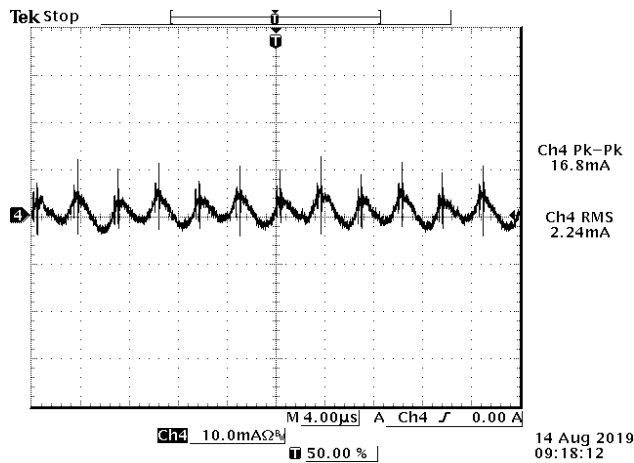

Figure 9. i_s (input reflected ripple current), AC component

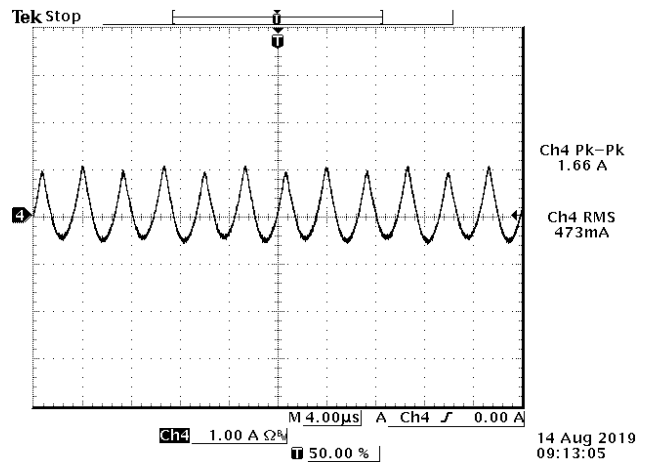

Figure 10. i_c (input terminal ripple current), AC component

Note: 54 Vdc input, 1500 W output, $T_a=25$ °C, with $C_{out} = 1470$ μ F (1000 μ F ceramic capacitor + 470 μ F POSCAP capacitor).

10. RIPPLE AND NOISE

Testing setup

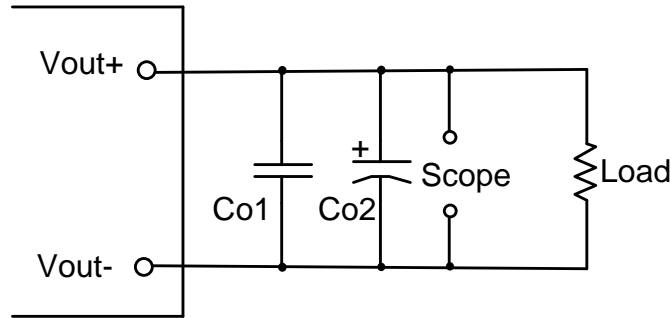

Figure 11.

Notes and values in testing.

Co1: 1000 uF ceramic capacitor

Co2: 470 uF POSCAP capacitor

The capacitor should be as close as possible to the power module to damp ripple current and enhance stability.

Below measured waveforms are based on above capacitance.

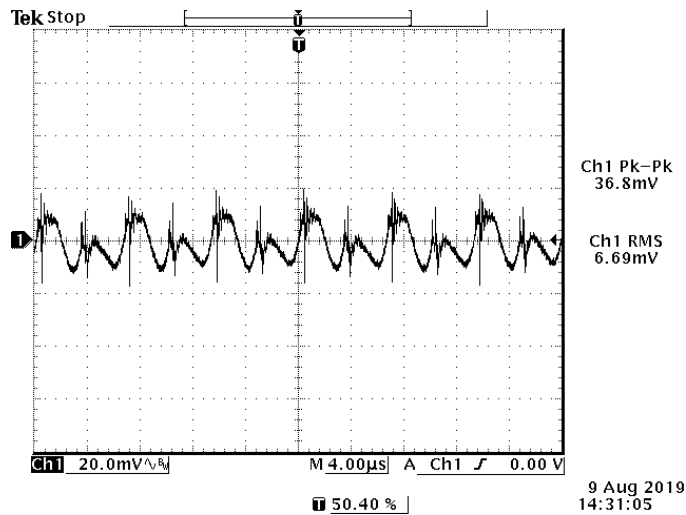

Figure 12. Ripple and noise waveform

Note: 54 Vdc input, 1500 W output, Ta=25 °C, with Cout = 1470 uF (1000 uF ceramic capacitor + 470 uF POSCAP capacitor).

11. TRANSIENT RESPONSE

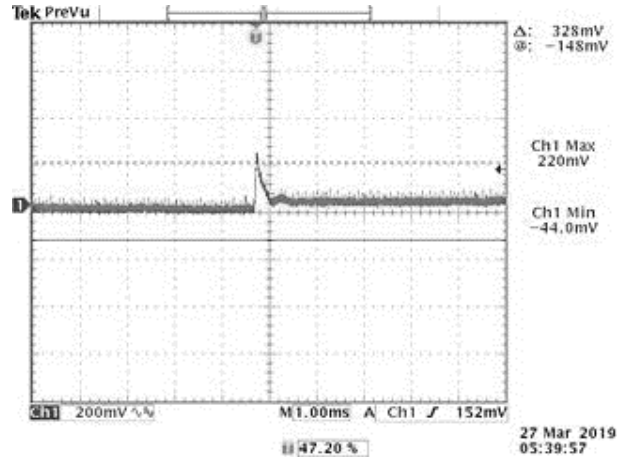
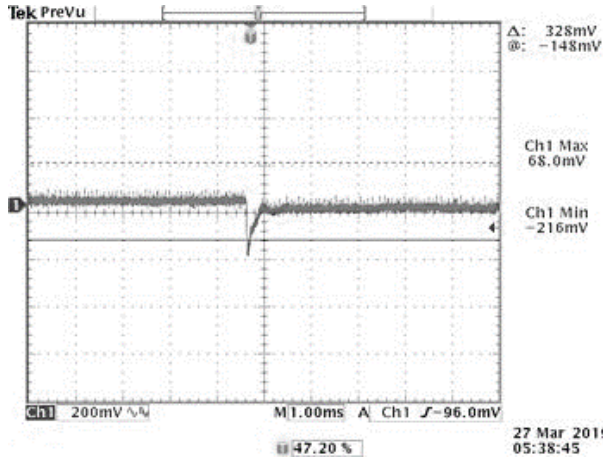

Figure 13. 50%-75% Load Transients at $V_{in} = 54 V @ T_a = 25^{\circ}C$

Figure 14. 75%-50% Load Transients at $V_{in} = 54 V @ T_a = 25^{\circ}C$

Note: 54 Vdc input, $T_a=25^{\circ}C$, with $C_{out} = 3400 \mu F$ (1000 μF ceramic capacitor + 3000 μF POSCAP capacitor).

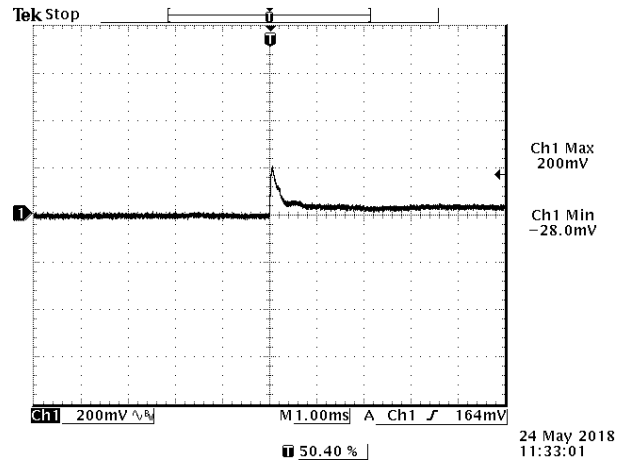
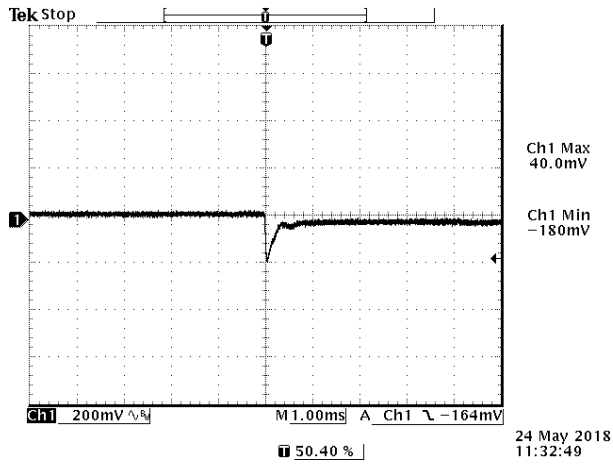

Figure 15. 50%-75% Load Transients at $V_{in} = 54 V @ T_a = 25^{\circ}C$

Figure 16. 75%-50% Load Transients at $V_{in} = 54 V @ T_a = 25^{\circ}C$

Note: 54 Vdc input, $T_a=25^{\circ}C$, with $C_{out} = 7000 \mu F$ (1000 μF ceramic capacitor + 6000 μF POSCAP capacitor).

12. STARTUP & SHUTDOWN

RISE TIME

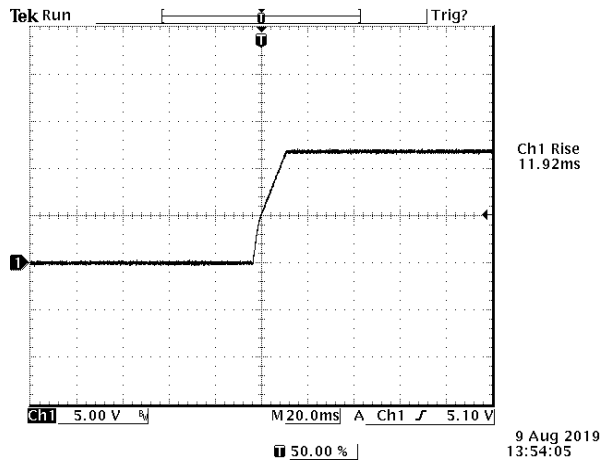

Figure 17. Rise Time

STARTUP TIME

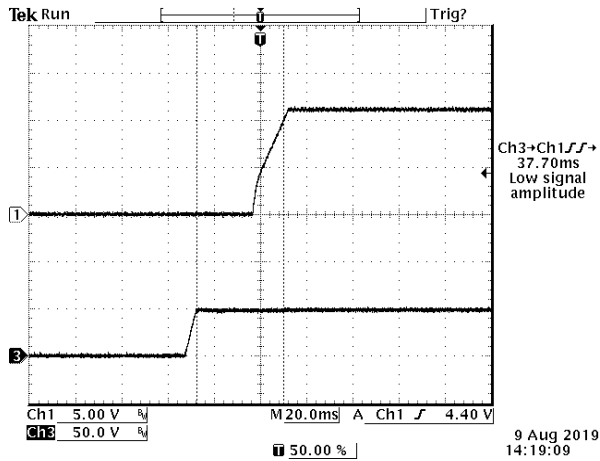

Figure 18. Startup from Vin; Ch1: Vo; Ch3: Vin

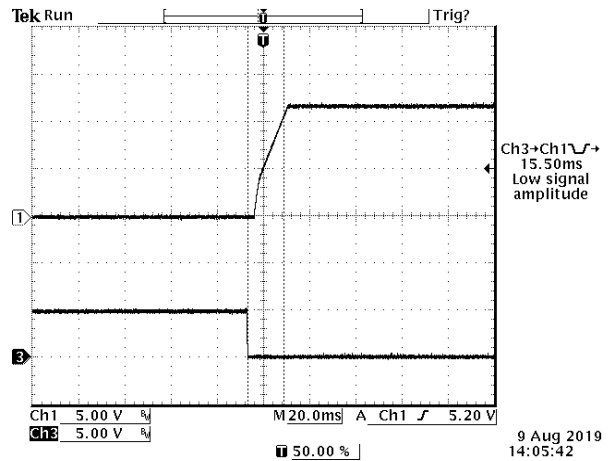

Figure 19. Startup from on/off; Ch1: Vo; Ch3: on/off

SHUT DOWN

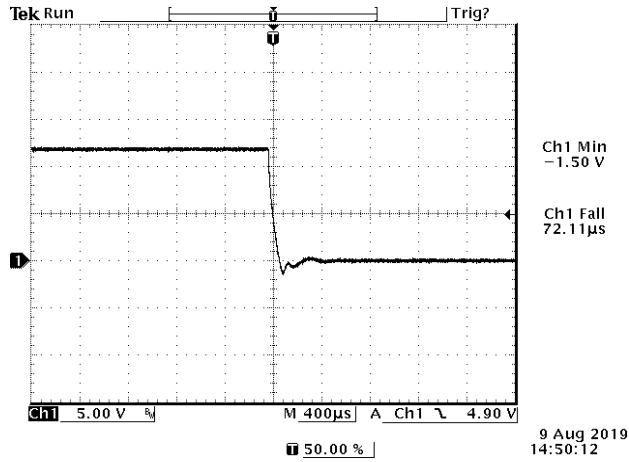

Figure 20. Shut Down

Note: 54 Vdc input, 1500 W output, Ta=25 °C, with Cout = 10000 uF (1000 uF ceramic capacitor + 9000 uF POSCAP capacitor).

13. OVER CURRENT PROTECTION

To provide protection in a fault output over-load condition, the module is equipped with internal over current protection circuitry. If the over current condition occurs, the module will shut down into hiccup mode and restart once every 250 ms. The module operates normally when the output current goes into specified range.

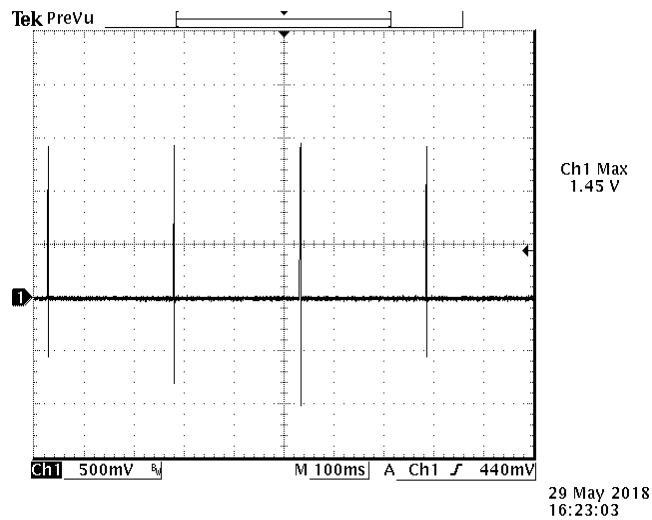

Figure 21. Over current protection
Vin = 54V @ Ta = 25 °C; CH1: Output Voltage

14. THERMAL DERATING CURVES

Hot spot location and allowed maximum temperature:

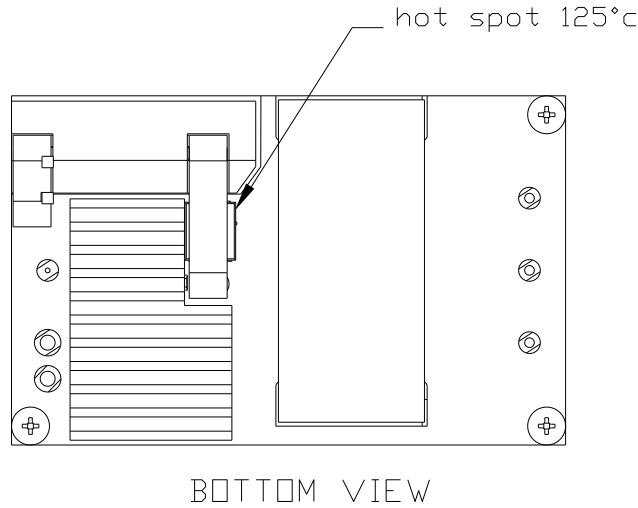

Figure 22. Module Bottom View hot spot

THERMAL CONSIDERATIONS

New high power architectures require an accurate thermal design. Design engineers have to optimize the module working conditions and ensure reliable operation. Convection cooling is the common mode to cool down the module. Heat transfer is dependent on a test setup and it is important to characterize the module in an environment similar to existent electronic applications. Reported thermal data reflects real operating conditions because the values are physically measured in a wind tunnel.

THERMAL TEST SETUP

A module in electronic cards is typically located in a busy area without relevant space around it. To simulate a real condition and avoid turbulence we add a cover with defined dimensions. The distance has to be 6.35 mm (0.25 inch) from the top of the module and 6.35 mm (0.25 inch) on the left and right side of the module. The values reflect most of the real applications and it is a common procedure in the power module market. Ambient temperature and airflow are measured in front of the module at the distance of 76.2 mm (3 inch).

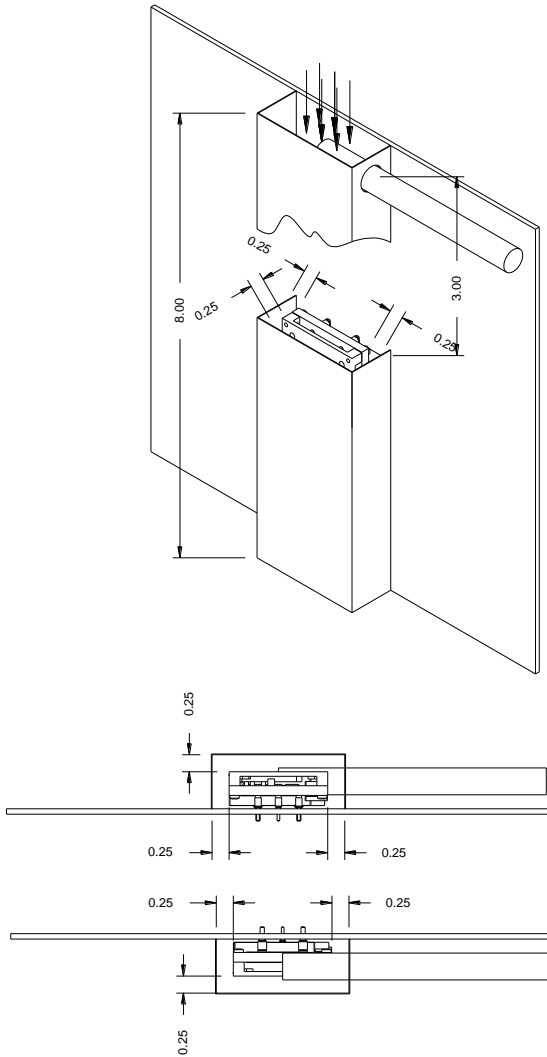

Figure 23. 0RQP-X5M12B

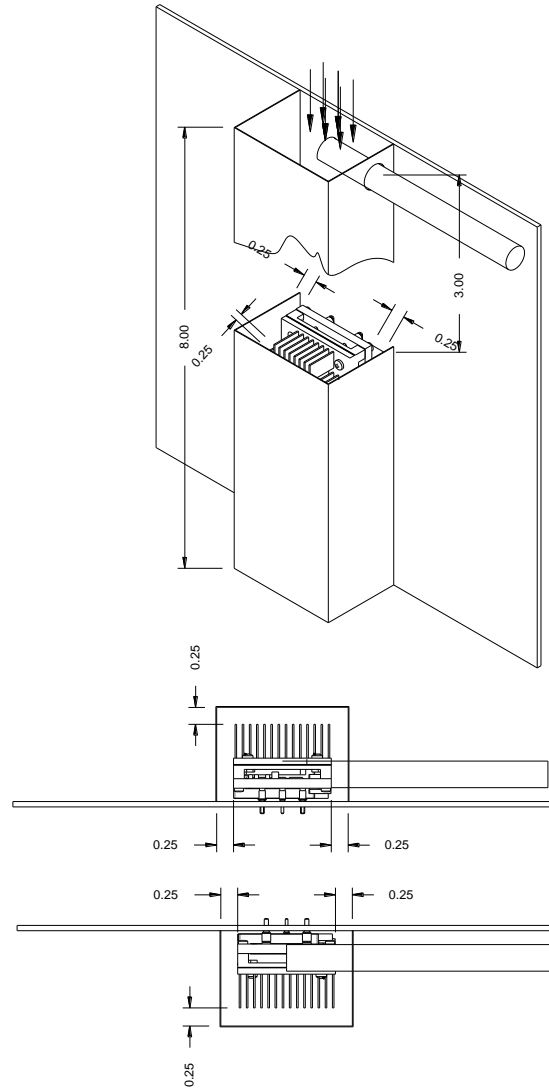

Figure 24. 0RQP-X5M12B + External heatsink

Test setup drawing all measures are in inch.

*The size of external heatsink is 2.30"×1.45"×0.61", recommended model number: S08CAA02 from ALPHA.

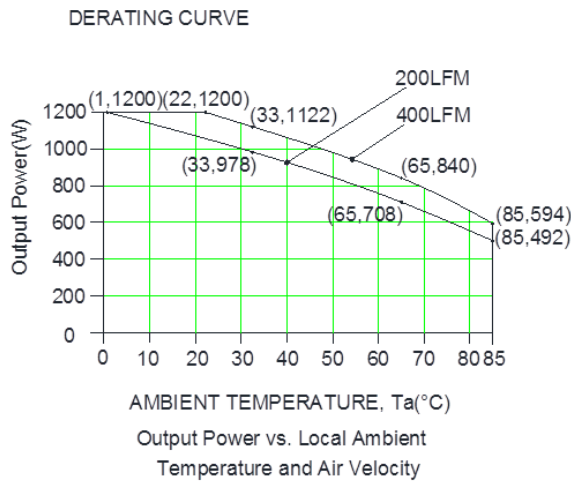

Figure 25. For ORQP-X5M12B

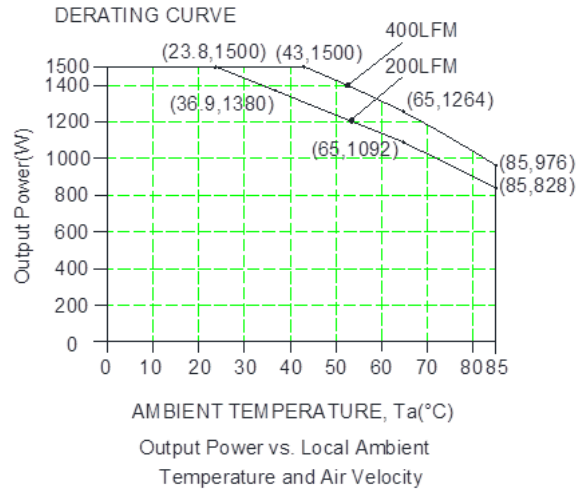

Figure 26. For ORQP-X5M12B + External heatsink

Note: Output power vs. ambient temperature and air velocity @Vin = 57 V (Longitudinal Orientation, airflow from Vout to Vin).

15. INPUT UNDER-VOLTAGE LOCKOUT

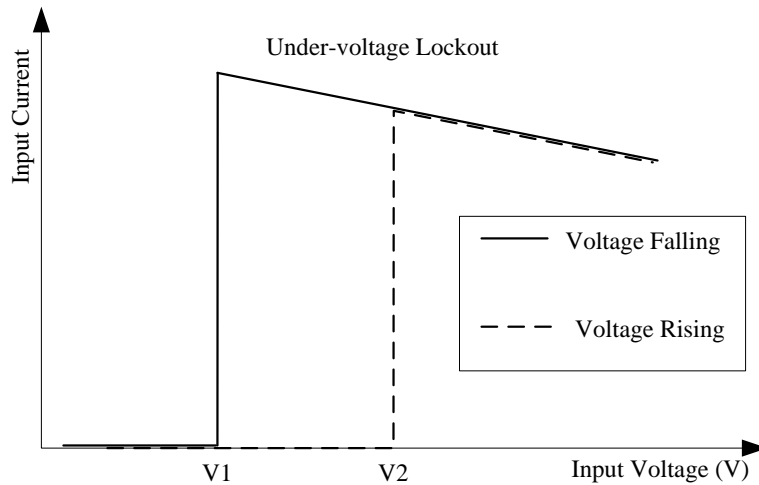

Figure 27. Input under-voltage lockout

V1 = 44 V; V2 = 47 V

16. POWER MANAGEMENT BUS

POWER MANAGEMENT BUS DIGITAL FEATURE DESCRIPTION

The module supports Power Management Bus to be monitored, controlled and configured by the system. More detailed Power Management Bus information can be found in the Power Management Bus Power Management Protocol Specification, Part I and part II, revision 1.3, which is shown in the System Management Interface Forum Web site: www.powerSIG.org. The supported Power Management Bus commands of the module are listed below in the Supported POWER MANAGEMENT BUS Commands section below.

The module supports three Power Management Bus signal lines: Data, Clock, Alert and one Address lines Addr.

Connection for the Power Management Bus interface should follow the High-Power DC specifications given in section 3.1.3 in the SMBus specification V2.0 or the Low Power DC specifications in section 3.1.2. The complete SMBus specification is shown in <http://smbus.org>.

SMBALERT protocol is supported. Alert line is also a wired-AND signal, by which the module can alert the Power Management Bus master via pulling the Alert pin to an active low to indicate a fault condition. The master will communicate with the slave module using the programmed address, and use the various READ_STATUS commands to find the cause for the Alert. The CLEAR_FAULTS command will clear the Alert.

The module also supports the Packet Error Checking (PEC) protocol. It can check the PEC byte provided by the Power Management Bus master, and include a PEC byte in all message transmitted back to the master.

POWER MANAGEMENT BUS ADDRESSING

The Module has configurable Power Management Bus addressing capability. By connecting different resistors from Addr pin to Vout(-) pin, 14 possible addresses can be acquired. The 7 bit Power Management Bus address is defined by the value of the resistor as shown in the table below, and +/-1% resistor accuracy is acceptable. If there is any resistance exceeding the requested range, address 127 will be returned.

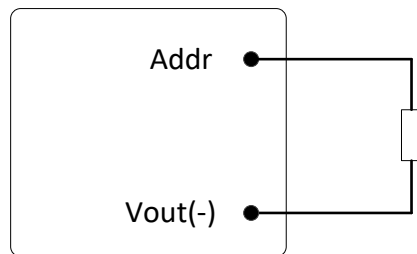

Figure 28.

Power Management Bus Address	Resistor (Kohm)
96	10
97	15
98	21
99	28
100	35.7
101	45.3
102	56.2
103	69.8
104	88.7
105	107
106	130
107	158
108	191
109	232

NOTE:

1. Power Management Bus communication is only supported when vin normal and remote on
2. If boot load function is needed, there can not be an I2C slave address of 0x58 on I2C bus

POWER MANAGEMENT BUS APPLICATION CIRCUIT

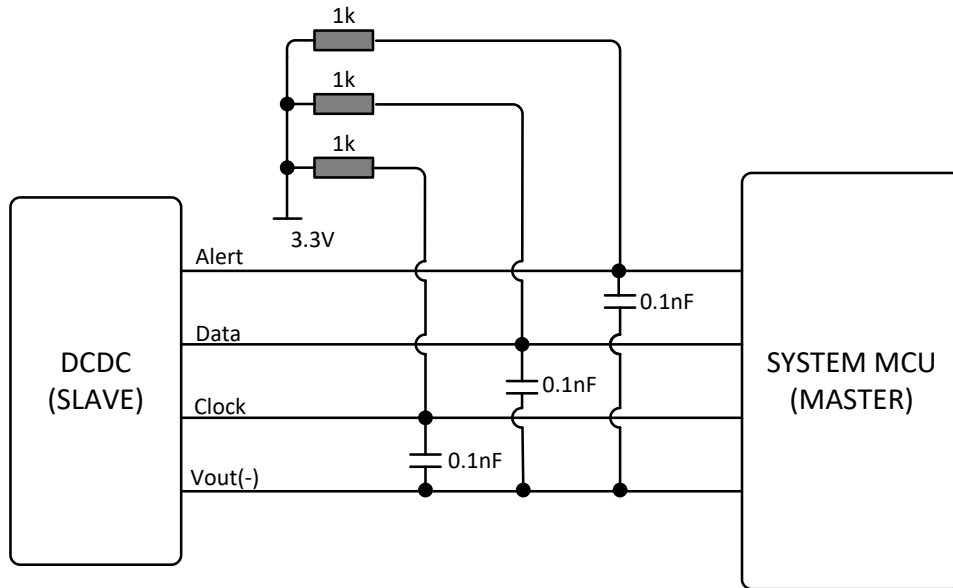

Figure 29. Power Management Bus Application Circuit

PARAMETER	NOTES	MIN	NOM	MAX	UNITS
Logic Input Low (VIL)	1	0		0.8	V
Logic Input High (VIH)	1	2.1		3.3	V
Logic Output Low (VOL)	2			0.65	V
Logic Output High (VOH)	3	2.3			V
Power Management Bus Operating Frequency Range			100/400		kHz
Output Current Reading Accuracy	4	-5		+5	%
	5	-3		+3	A
Output Voltage Reading Accuracy		-2		+2	%
Input Voltage Reading Accuracy		-4		+4	%
Temperature Reading Accuracy		-5		+5	°C
Notes					
1	Data, Clock pin				
2	Data, Alert, Clock pin; IOL=4mA				
3	Data, Alert, Clock pin; IOH=-4mA				
4	Vin=54V, Io=50% ~ 100% of Iomax;				
5	Vin=54V, Io=5% ~ 50% of Iomax;				

BLACK BOX

Black Box function is supported which has 10K erase cycles. Vin UVLO and Vin OVP event may not accurately record in black box. Black box only stores at the first fault event until next Vin power cycle or remote on/off cycle. 20 history information are stored in flash memory and each history information has 32 record content which is shown as below. EVENT# is the history event offset value. Every 20 history event store operation erase the flash once.

ADDRESS OFFSET	CONTENT
0	EVENT#
1	STATUS_WORD_HIGH_BYTE
2	STATUS_WORD_LOW_BYTE
3	STATUS_VOUT
4	STATUS_IOUT
5	STATUS_INPUT
6	STATUS_TEMPERATURE
7	STATUS_CML
8	VIN_DATA_HIGH_BYTE
9	VIN_DATA_LOW_BYTE
10	VOUT_DATA_HIGH_BYTE
11	VOUT_DATA_LOW_BYTE
12	IOUT_DATA_HIGH_BYTE
13	IOUT_DATA_LOW_BYTE
14	TEMPERATURE_DATA_HIGH_BYTE
15	TEMPERATURE_DATA_LOW_BYTE
16	FAULT_TIME_FIRST_BYTE
17	FAULT_TIME_SECOND_BYTE
18	FAULT_TIME_THIRD_BYTE
19	FAULT_TIME_FOURTH_BYTE
20~31	N/A

POWER MANAGEMENT BUS DATA FORMAT

For commands which is except to the output voltage, including input voltage, output current, temperature, PWM frequency, duty cycle, the controller will use the 2-byte linear format as defined by the Power Management Bus system management protocol. The linear data format contains 2 bytes which include a 5-bit two’s complement exponent and an 11-bit two’s complement mantissa as below. The transmitted value Y is reported as the form $Y = X * 2^N$.

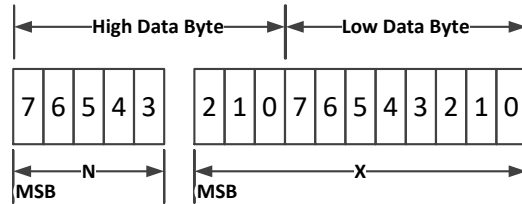

For example, to set the over temperature fault threshold 130 deg C by OT_FAULT_LIMIT command, the read/write data can be calculated refer to below: the binary number of N is 0, whose decimal number is 0.

$X = T_{OTP} / 2^{(0)} = 130$, whose binary is 0b00010000010.

Combine X and N, the binary is 0b0000000010000010. The hexadecimal of OT_FAULT_LIMIT is 0x0082.

The output voltage parameters use the Power Management Bus Vout linear format. The data format is shown below.

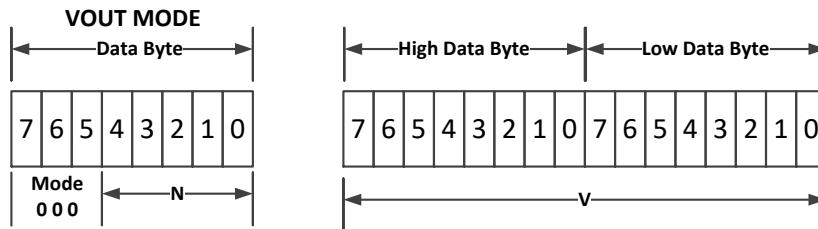

The voltage will be in the form $Voltage = V * 2^N$. The Mantissa and exponent in this equation will be read and reported using 3 bytes. The first byte is the VOUT_MODE byte which will always contain 000 in the 3 MSB’s. The 5 LSB’s are the exponent. The exponent N is fixed and equals -10. The other 2 bytes N will contain the Mantissa. In the above format N is a 5-bit two’s complement binary integer and V is a 16-bit unsigned binary integer. All 16 bits are reported to be compatible with the Power Management Bus protocol. For example, to set Vout to 12V by VOUT_COMMAND, the read/write data can be calculated refer to below process:

$V = Vout / 2^{(-10)} = 12 / 2^{(-10)} \approx 12288$

Convert the decimal to hexadecimal format is 0x3000. So the VOUT_COMMAND is 0x3000.

SUPPORTED POWER MANAGEMENT BUS COMMANDS

The main Power Management Bus commands described in the Power Management Bus 1.3 specification are supported by the module. Partial Power Management Bus commands are fully supported; Partial Power Management Bus commands have difference with the definition in Power Management Bus 1.3 specification. All the supported Power Management Bus commands are detailed summarized in the below table.

COMMAND	CODE	COMMAND DESCRIPTION	TYPE	DATA FORMAT	DEFAULT VALUE	DATA UNITS	NOTE
OPERATION	0x01	Configures the operational state of the module	R/W byte	Bit field	0x80	/	1
ON_OFF_CONFIG	0x02	Configures the combination of CONTROL pin input and serial bus commands needed to turn the module on and off	Read byte	Bit field	0x1C	/	1,2
CLEAR_FAULTS	0x03	Clear any fault bits that have been set	Send byte	/	/	/	/
WRITE_PROTECTION	0x10	Set or Clear the bit of Write protection	R/W byte	Bit field	0x80	/	1
RESTORE_DEFAULT_ALL	0x12	Restore the factory settings to the non-volatile memory	Write	/	/	/	5
STORE_DEFAULT_ALL	0x15	Store the current settings to the non-volatile memory	Write	/	/	/	5
VOUT_MODE	0x20	Vo data format	Read byte	mode exponent ⁺	0x16	/	/
VOUT_COMMAND	0x21	Set the output voltage normal value	R/W word	Vout linear	12.0	Volts	/
VOUT_MAX	0x24	Set an upper limit on the output voltage the module can command	Read word	Vout linear	12.6	Volts	/
VOUT_MARGIN_HIGH	0x25	Set the output voltage margin high value	Read word	Vout linear	12.5	Volts	/
VOUT_MARGIN_LOW	0x26	Set the output voltage margin low value	Read word	Vout linear	10	Volts	/
VOUT_MIN	0x2B	Set a lower limit on the output voltage the module can command	Read word	Vout linear	8	Volts	/
MAX_DUTY	0x32	Set the maximum duty cycle	Read word	Linear	50	%	/
FREQUENCY_SWITCH	0x33	Set the primary side switching frequency	Read word	Linear	150	kHz	/
VOUT_OV_FAULT_LIMIT	0x40	Set the output over voltage fault threshold	R/W word	Vout linear	13.5	Volts	4
VOUT_OV_FAULT_RESPONSE	0x41	Instructs what action to take in response to an output overvoltage fault	Read byte	Bit field	0x80	/	1
IOUT_OC_FAULT_LIMIT	0x46	Set the output overcurrent fault threshold	R/W word	Linear	145	A	3,4
IOUT_OC_FAULT_RESPONSE	0x47	Instructs what action to take in response to an output overcurrent fault	Read byte	Bit field	0xF8	/	1
OT_FAULT_LIMIT	0x4F	Set the over temperature fault threshold	R/W word	Linear	135	Deg C	3,4
OT_FAULT_RESPONSE	0x50	Instructs what action to take in response to an over temperature fault	Read byte	Bit field	0xB8	/	1
STATUS_WORD	0x79	Returns the information with a summary of the unit's fault condition	Read word	Bit field	0	/	1,6
STATUS_VOUT	0x7A	Returns the information with a summary of the unit's output voltage condition	Read byte	Bit field	0	/	1,6
STATUS_IOUT	0x7B	Returns the information with a summary of the unit's output current condition	Read byte	Bit field	0	/	1,6
STATUS_TEMPERATURE	0x7D	Returns the information with a summary of the unit's temperature condition	Read byte	Bit field	0	/	1,6
STATUS_CML	0x7E	Returns the information with a summary of the unit's communication condition	Read byte	Bit field	0	/	1,6
READ_VIN	0x88	Returns the input voltage of the module	Read word	Linear	/	Volts	/
READ_VOUT	0x8B	Returns the output voltage of the module	Read word	Vout Linear	/	Volts	/
READ_IOUT	0x8C	Returns the output current of the module	Read word	Linear	/	A	/
READ_TEMPERATURE_1	0x8D	Returns the temperature of the module	Read word	Linear	/	Deg C	/
POWER MANAGEMENT BUS_REVISION	0x98	Reads the revision of the Power Management Bus	Read byte	Bit field	0x33	/	1
MFR_ID	0x99	Reads the ID of the manufacture	Read block	ASCII	BELF	/	/

COMMAND	CODE	COMMAND DESCRIPTION	TYPE	DATA FORMAT	DEFAULT VALUE	DATA UNITS	NOTE
FIRMWARE_REV	0x9B	Reads the revision of the firmware	Read block	ASCII	A1*	/	7
BLACKBOX_EN	0xDF	Enable or disable the black box overwrite function	Read byte	Bit field	0x01	/	1
READ_HISTORY_EVENTS	0xE0	Read history event from black box	Read block	Bit field	/	/	1
SET_HISTORY_EVENT_OFFSET	0xE1	Set history event offset	R/W byte	Bit field	/	/	1

* The value changed with the revision of the firmware.

NOTES:

1. Refer to below detailed command description
2. OPERATION command controls module on/off
3. Before write operation, it is necessary to read the register data and parse out the corresponding linear format N value, then convert write value based on N.
4. In order to ensure that the product works properly, the adjustment range of the protection limit value is limited, when the set value exceeds the upper or lower limits, the lower limit value is automatically set. The following table shows the upper and lower limits

COMMAND	CODE	THE LOW LIMIT	THE UPPER LIMIT
VOUT_OV_FAULT_LIMIT	0x40	10	13.7
IOUT_OC_FAULT_LIMIT	0x46	20	145
OT_FAULT_LIMIT	0x4F	120	140

5. Read or write this command, PSU will shut down until next vin power cycle
6. ALL the warning or fault bits set in all the status registers remain set, even if the fault or warning condition is removed or corrected, until one of the following occur:
 - 1) A remote on/off cycle;
 - 2) The device receives a CLEAR_FAULTS command;
 - 3) Vin power is removed from the module.
7. Block read command, byte count=2.



Asia-Pacific
+86 755 298 85888

Europe, Middle East
+353 61 49 8941

North America
+1 866 513 2839

OPERATION (0x01)				
Bit number	Purpose	Bit value	Meaning	Default settings
7	Turn the module on/off	1	On	1
		0	Off	
6	Reserved	/	/	0
5:4	Control the source of the output voltage command	00	VOUT_COMMAND	00
		01	VOUT_MARGIN_LOW	
		10	VOUT_MARGIN_HIGH	
3:0	Reserved	11	/	0000
		/	/	

ON_OFF_CONFIG (0x02)				
Bit number	Purpose	Bit value	Meaning	Default settings
7:5	Reserved	/	/	000
4	Module powers up regardless of the state of the CONTROL pin and OPERATION command or not	0	/	1
		1	Wait CONTROL and OPERATION	
3	Module powers up regardless of the state of the OPERATION command or not	0	/	1
		1	Wait OPERATION command	
2	Module powers up regardless of the state of the CONTROL pin or not (Not supported)	0	/	1
		1	Wait CONTROL pin	
1:0	Reserved	/	/	00

WRITE_PROTECTION (0x10)				
Bit number	Purpose	Bit value	Meaning	Default settings
7	Enable / Disable the protection	1	Protection is enabled	1
		0	Protection is disabled	
6:0	Reserved	/	/	0000000

VOUT_OV_FAULT_RESPONSE (0x41)				
Bit number	Purpose	Bit value	Meaning	Default settings
7:6	Response when fault happens	00-01	/	10
		10	The module shuts down and response according to the retry setting in bits [5:3]	
		11	/	
5:3	Retry setting	000	Module does not attempt to restart until a RESET signal or OPERATION command, or Bias power is removed	000
		001-110	/	
		111	Attempts to restart continuously until it is commanded off	
2:0	Reserved	/	/	000

IOUT_OC_FAULT_RESPONSE (0x47)				
Bit number	Purpose	Bit value	Meaning	Default settings
7:6	Response when fault happens	00-10	/	11
		11	The module shuts down and response according to the retry setting in bits [5:3]	
5:3	Retry setting	000	Module does not attempt to restart until a RESET signal or OPERATION command, or Bias power is removed	111
		001-110	/	
		111	Attempts to restart continuously until it is commanded off	
2:0	Reserved	/	/	000

OT_FAULT_RESPONSE (0x50)				
Bit number	Purpose	Bit value	Meaning	Default settings
7:6	Response when fault happens	00-01	/	10
		10	The module shuts down and response according to the retry setting in bits [5:3]	
		11	/	
5:3	Retry setting	000	Module does not attempt to restart until a RESET signal or OPERATION command, or Bias power is removed	111
		001-110	/	
		111	Attempts to restart continuously until it is commanded off	
2:0	Reserved	/	/	000

STATUS_WORD (0x79)				
HIGH BYTE				
Bit number	Purpose	Bit value	Meaning	Default settings
7	VOUT	1	An output voltage fault has occurred	0
		0	Not occurred	
6	IOUT/POUT	1	An output current or output power fault has occurred	0
		0	Not occurred	
5	INPUT (Not supported)	1	An input overvoltage fault has occurred	0
		0	Not occurred	
4	Reserved	/	/	0
3	Power_Good	1	Power_Good signal is negated	0
		0	Power_Good signal is ok	
2:1	Reserved	/	/	00
0	UNKNOWN	1	A fault type not given in bits [15:1] of the STATUS_WORD has been detected	0
		0	Not occurred	



STATUS_WORD (0x79)				
LOW BYTE				
Bit number	Purpose	Bit value	Meaning	Default settings
7	Busy	1	A fault was declared because the device was busy and unable to respond	0
		0	Not occurred	
6	Off	1	This bit is asserted if the unit is not providing power to the output, regardless of the reason, including simply not being enabled	0
		0	Not occurred	
5	VOUT_OV_FAULT	1	An output overvoltage fault has occurred	0
		0	Not occurred	
4	IOUT_OC_FAULT	1	An output overcurrent fault has occurred	0
		0	Not occurred	
3	VIN_UV_FAULT (Not supported)	1	An input under voltage fault has occurred	0
		0	Not occurred	
2	TEMPERATURE	1	A temperature fault has occurred	0
		0	Not occurred	
1	CML	1	A communication, memory or logic fault has occurred	0
		0	Not occurred	
0	NONE_OF_THE_ABOVE	1	A fault not listed in bits [7:1] of this byte has occurred	0
		0	Not occurred	

STATUS_VOUT (0x7A)				
Bit number	Purpose	Bit value	Meaning	Default settings
7	VOUT_OV_FAULT	1	Occurred	0
		0	Not occurred	
6:5	Reserved	/	/	00
4	VOUT_UV_FAULT	1	Occurred	0
		0	Not occurred	
3:0	Reserved	/	/	0000

STATUS_IOUT (0x7B)				
Bit number	Purpose	Bit value	Meaning	Default settings
7	IOUT_OC_FAULT	1	Occurred	0
		0	Not occurred	
6:0	Reserved	/	/	0000000

STATUS_TEMPERATURE (0x7D)				
Bit number	Purpose	Bit value	Meaning	Default settings
7	OT_FAULT	1	Occurred	0
		0	Not occurred	
6:0	Reserved	/	/	0000000

STATUS_CML (0x7E)				
Bit number	Purpose	Bit value	Meaning	Default settings
7	Invalid or unsupported command received	1	Occurred	0
		0	Not occurred	
6	Invalid or unsupported data received	1	Occurred	0
		0	Not occurred	
5:0	Reserved	/	/	000000

POWER MANAGEMENT BUS_REVISION (0x98)				
Bit number	Purpose	Bit value	Meaning	Default settings
7:4	Indicate the revision of Power Management Bus Specification Part I to which the device is compliant	0000	1.0	1.3
		0001	1.1	
		0010	1.2	
		0011	1.3	
3:0	Indicate the revision of Power Management Bus Specification Part II to which the device is compliant	0000	1.0	1.3
		0001	1.1	
		0010	1.2	
		0011	1.3	

BLACKBOX_EN (0xDF)				
Bit number	Purpose	Bit value	Meaning	Default settings
7:1	Reserved	/	/	0000000
0	Enable/Disable the black box overwrite function	1	Overwrite function is enabled	1
		0	Overwrite function is disabled	

Note: if overwrite function is disabled, black box only records 20 times faults, then it will lock and no more faults will be recorded. If overwrite function is enabled. When fault log is full, the new fault will overwrite all the previous fault, and recount from history event offset value 1.



Asia-Pacific
+86 755 298 85888

Europe, Middle East
+353 61 49 8941

North America
+1 866 513 2839

HISTORY EVENT READ

0xE1 command: Write the offset value to slave to decide which history event for read.

0XE0 command: Read the history data after 0xE1 command.

READ HISTORY EVENT OFFSET (0xE1)

Send read command 0xE1 and read one byte, it will return the next history event log offset value x.

START	DEVICE ADDRESS & W	COMMAND (0xE1)	REPEATED START	DEVICE ADDRESS & R
-------	--------------------	----------------	----------------	--------------------

EVENT LOG OFFSET VALUE	PEC	STOP
------------------------	-----	------

SET HISTORY EVENT OFFSET (0xE1)

Then send write command 0xE1 and write the offset value X-1 to read back the last history event. The maximum value of the offset is 20, if the history data is large than 20, it will recount from 1.

READ HISTORY EVENTS [0xE0]

START	DEVICE ADDRESS & W	COMMAND (0XE0)	REPEATED START	DEVICE ADDRESS & R	Byte Count=20	EVENT#
-------	--------------------	----------------	----------------	--------------------	---------------	--------

STATUS_WORD_HIGH_BYTE	STATUS_WORD_LOW_BYTE	STATUS_VOUT	STATUS_IOUT	STATUS_INPUT
-----------------------	----------------------	-------------	-------------	--------------

STATUS_TEMPERATURE	STATUS_CML	VIN_DATA_HIGH_BYTE	VIN_DATA_LOW_BYTE	VOUT_DATA_HIGH_BYTE
--------------------	------------	--------------------	-------------------	---------------------

VOUT_DATA_LOW_BYTE	IOUT_DATA_HIGH_BYTE	IOUT_DATA_LOW_BYTE	TEMPERATURE_DATA_HIGH_BYTE
--------------------	---------------------	--------------------	----------------------------

TEMPERATURE_DATA_LOW_BYTE	FAULT_TIME_FIRST_BYTE	FAULT_TIME_SECOND_BYTE
---------------------------	-----------------------	------------------------

FAULT_TIME_THIRD_BYTE	FAULT_TIME_FOURTH_BYTE	PEC	STOP
-----------------------	------------------------	-----	------

17. SOLDERING INFORMATION

The module is designed to be compatible with a reflow soldering process. The suggested Pb-free solder paste is Sn/Ag/Cu (SAC). The recommended reflow profile using Sn/Ag/Cu solder is shown in the following. Recommended reflow peak temperature is 245°C while the part can withstand peak temperature of 260°C maximum for 10 seconds. This profile should be used only as a guideline. Many other factors influence the success of SMT reflow soldering. Since your production environment may differ, please thoroughly review these guidelines with your process engineers.

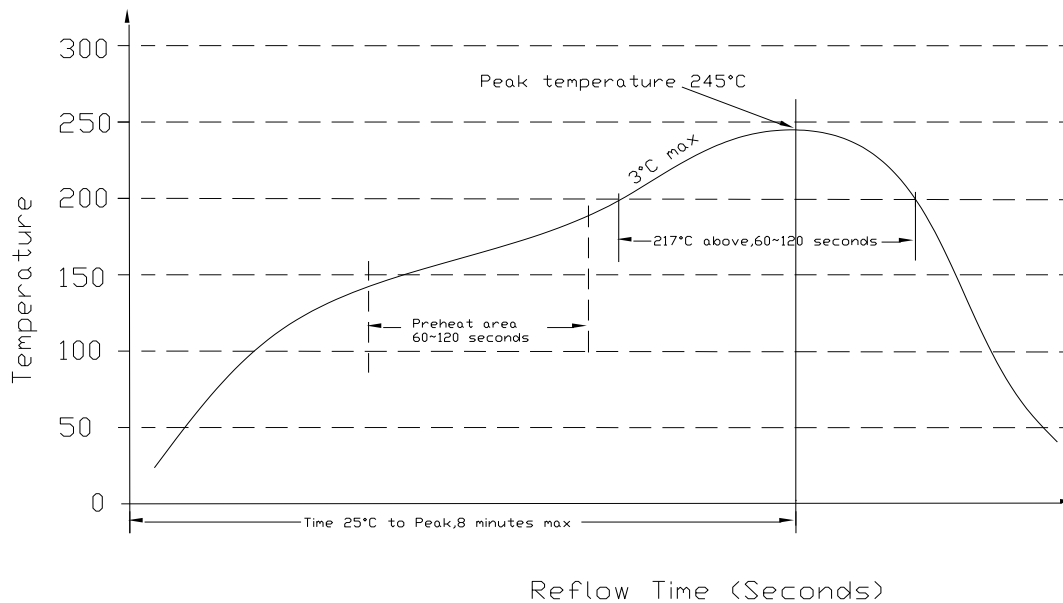

Figure 30. Soldering temperature

Note: Chapter 17,18,19,20 do not apply to 0RQP-X5M12BAG.

18. MSL RATING

The module has a MSL rating of 3.

19. STORAGE AND HANDLING

The module is designed to be compatible with J-STD-033 Rev: A (Handling, Packing, Shipping and Use of Moisture /Reflow Sensitive surface Mount devices). Moisture barrier bags (MBB) with desiccant are applied. The recommended storage environment and handling procedure is detailed in J-STD-033.

20. PRE-BAKING

This component has been designed, handled, and packaged ready for pb-free reflow soldering. If the assembly shop follows J-STD-033 guidelines, no pre-bake of this component is required before being reflowed to a PCB. However, if the J-STD-033 guidelines are not followed by the assembler, Bel recommends that the modules should be pre-baked @ 120~125°C for a minimum of 4 hours (preferably 24 hours) before reflow soldering.

21. MECHANICAL DIMENSIONS

0RQP-X5M12BG / 0RQP-X5M12BAG OUTLINE

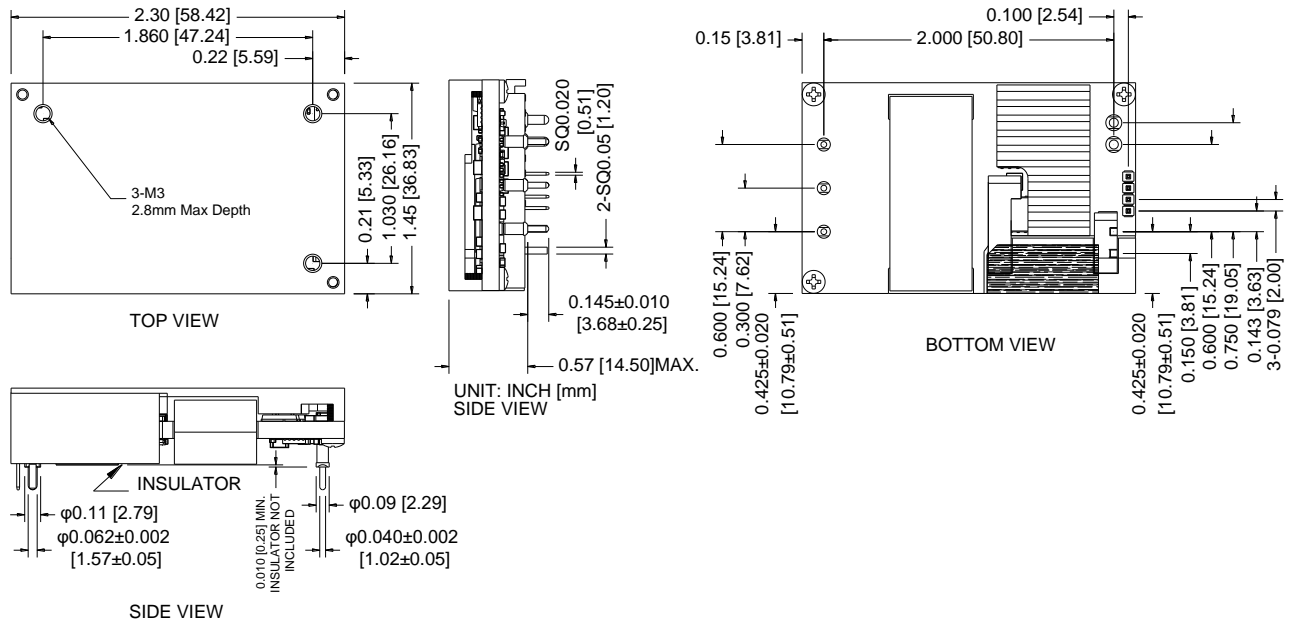

Figure 31. 0RQP-X5M12BG / 0RQP-X5M12BAG outline

NOTES:

- 1) All Pins: Material - Copper Alloy; Finish - Tin plated
- 2) Un-dimensioned components are shown for visual reference only.
- 3) All dimensions in inch [mm]; Tolerances: x.xx +/-0.02 inch [0.51 mm].
x.xxx +/-0.010 inch [0.25 mm].

ORQP-X5M12AG OUTLINE

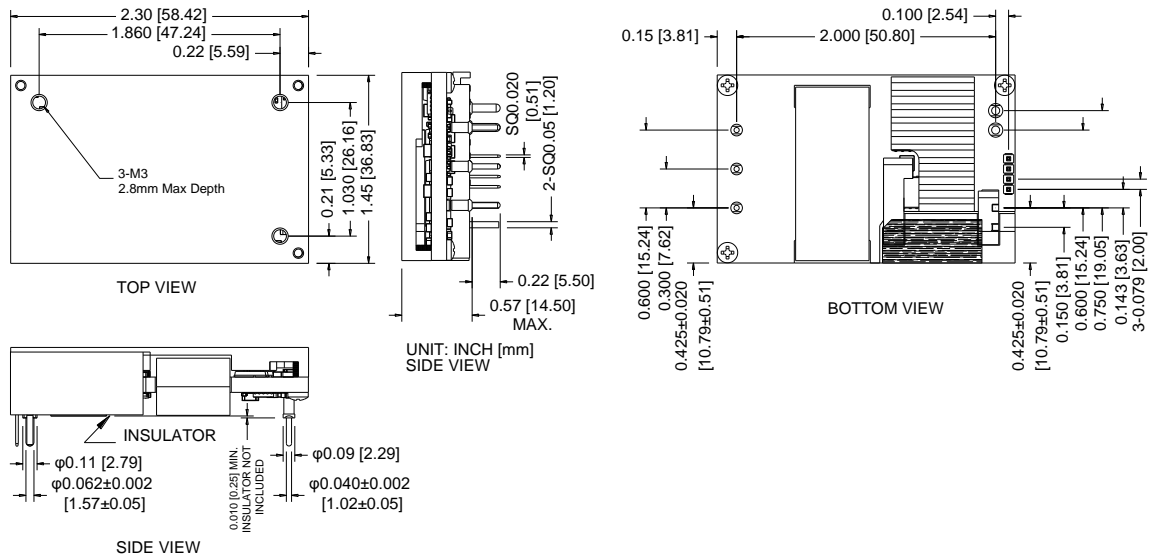

Figure 32. ORQP-X5M12AG outline

NOTES:

- 2) All Pins: Material - Copper Alloy;
Finish - Tin plated
- 2) Un-dimensioned components are shown for visual reference only.
- 3) All dimensions in inch [mm]; Tolerances: x.xx +/-0.02 inch [0.51 mm].
x.xxx +/-0.010 inch [0.25 mm].

RECOMMENDED PAD LAYOUT (ALL MODULES)

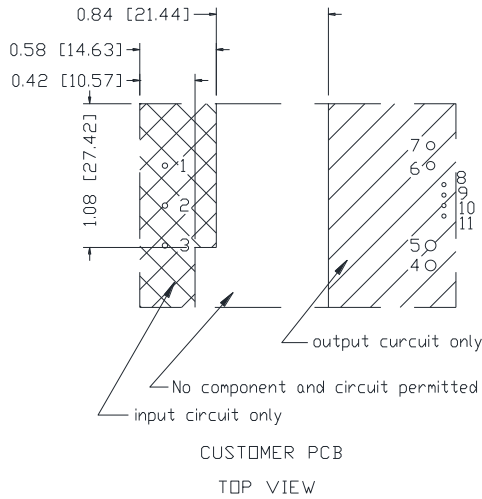

Figure 33. Recommended Pad Layout-1

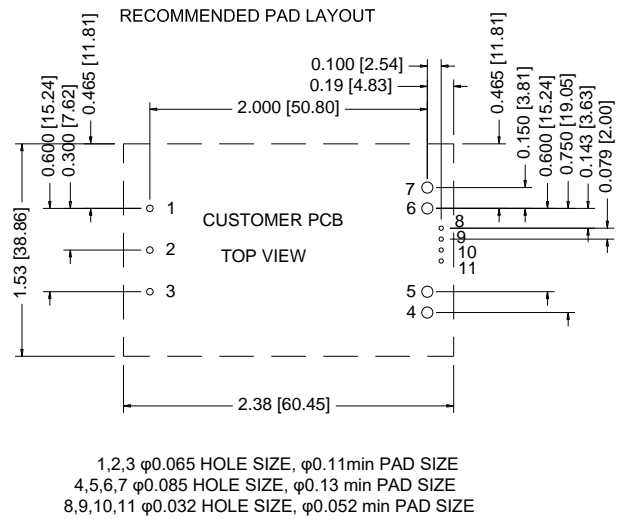

Figure 34. Recommended Pad Layout-2

PIN DEFINITIONS (ALL MODULES)

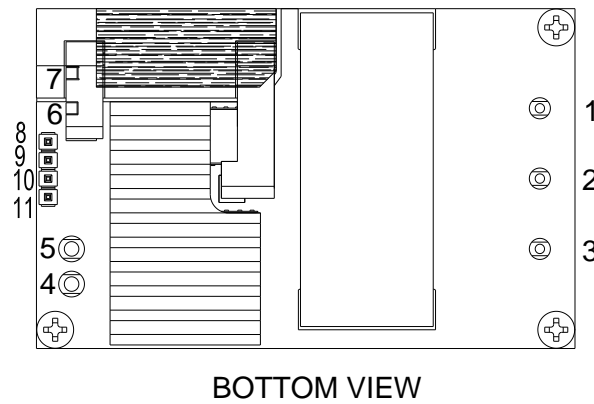

Figure 35. Pins

PIN	FUNCTION	DESCRIPTION	PIN SIZE
1	Vin (+)	Positive input voltage	0.04"
2	ON/OFF	Input to turn converter on and off, referenced to Vin(-)	0.04"
3	Vin (-)	Negative input voltage	0.04"
4	Vout(-)	Negative output voltage	0.062"
5	Vout(-)	Negative output voltage	0.062"

PIN	FUNCTION	DESCRIPTION	PIN SIZE
6	Vout(+)	Positive output voltage	SQ0.05"
7	Vout(+)	Positive output voltage	SQ0.05"
8	Addr	Power Management Bus address	SQ0.02"
9	Clock	Power Management Bus clock	SQ0.02"
10	Alert	Power Management Bus alert	SQ0.02"
11	Data	Power Management Bus data	SQ0.02"

22. FEATURE DISCRIPTIONS

OUTPUT OVER CURRENT PROTECTION

The module is equipped with internal output current limiting circuitry and can endure limiting current continuously. If the output current exceeds the limited value, the module will shutdown and enter either hiccup mode or latch mode, which is stated in the output spec table previously.

For hiccup mode, the module will try to restart after shutdown. If the over current situation still exists, the module will shut down continuously until this fault condition is cleared. The hiccup interval time is 250ms.

For latch mode, the module will latch off once shutdown. The latch mode can be reset by cycling the input power or resetting the remote on/off pin.

OVER TEMPERATURE PROTECTION

The module is equipped with internal over temperature protection circuitry to safeguard against thermal damage. If the maximum device reference temperature exceeds the limited value, the module will shutdown and enter either auto-recovery mode or latch mode, which is stated in the general spec table previously.

For auto-recovery mode, the module will keep monitoring the reference temperature after shutdown and auto restart once the temperature is lower than the protection threshold by ~20C hysteresis.

For latch mode, the module will latch off once shutdown. The latch mode can be reset by cycling the input power or resetting the remote on/off pin.

UNDER/OVER INPUT VOLTAGE PROTECTION

The module is equipped with internal input UVLO and OVLO protection. If the input voltage is below the UV threshold or above the OV threshold, the module will shutdown and auto-restart once the input voltage is within the limited range which is stated in the input spec table previously.

23. REVISION HISTORY

DATE	REVISION	CHANGES DETAIL	APPROVAL
2019-02-25	AA	First release.	J.Yao
2019-03-20	AB	Remove the Power Good pin and add PIH.	J.Yao
2019-05-23	AC	Increase peak output power maximum.	J.Yao
2019-08-19	AD	Update absolute maximum ratings, isolation characteristics and others.	J.Yao
2019-11-08	AE	Update External heatsink size.	J.Yao
2020-06-15	AF	Update mechanical dimensions.	J.Yao
2020-07-01	AG	Update module photo.	J.Yao
2020-08-21	AH	Delete preliminary watermark.	J.Yao
2020-11-04	AI	Update MTBF.	J.Yao
2020-12-01	AJ	Update mechanical outline notes.	J.Yao
2021-02-09	AK	Add safety certificate and recommended pad layout. Update altitude.	J.Yao
2021-04-15	AL	Add object ID. Update power management bus information.	J.Yao
2021-06-25	AM	Update mechanical outline by correcting the tolerance. Update thermal test setup drawings by correcting the height. Update power management bus information and efficiency data curves. Add 0RQB-X5M12BAG.	J.Yao
2022-04-21	AN	Add new PN 0RQP-X5M12AG. Add note: chapter 17,18,19,20 do not apply to 0RQP-X5M12BAG.	J.Yao

For more information on these products consult: tech.support@psbel.com

NUCLEAR AND MEDICAL APPLICATIONS - Products are not designed or intended for use as critical components in life support systems, equipment used in hazardous environments, or nuclear control systems.

TECHNICAL REVISIONS - The appearance of products, including safety agency certifications pictured on labels, may change depending on the date manufactured. Specifications are subject to change without notice.