

0RQP-E0T12

Isolated DC-DC Converter

The 0RQP-E0T12 is an isolated DC-DC converter that provides up to 800 W of output power in a quarter brick footprint.

It operates over an input voltage range of 36 V to 75 V and delivers a nominal 12 VDC output, making it suitable for industrial and telecommunication applications.

Multiple protections include short circuit protection, over current protection, under-voltage lockout, over-temperature protection and remote on/off. All operating features can be configured and monitored through digital interface.

The 0RQP-E0T12 is rated Class 2 and Category 2 and is safety approved to the latest IEC/EN 62368-1, UL/CSA 62368-1 standards.



Key Features & Benefits

- 36 – 75 VDC Telco Input
- 12 VDC / 66.8 A Output
- Industry Standard 1/4 Brick Converter with DOSA Footprint
- Fixed Frequency
- High Efficiency
- Input Under / Over Voltage Lockout
- Over Current Protection, Short Circuit Protection, Over Temperature Protection, Over Overvoltage Protection
- Digital Communication Interface for Monitoring and Control
- TRIM
- Remote Sense
- Approved to IEC/EN 62368-1, UL/CSA 62368-1 and IEC/EN 60950-1
- Class II, Category 2, Isolated DC/DC Converter (refer to IPC-9592B)
- Dimensions: 2.30 x 1.45 x 0.51 in (58.42 x 36.83 x 13.00 mm)

Applications

- Industrial
- Telecommunications

1. MODEL SELECTION

MODEL NUMBER	OUTPUT VOLTAGE	INPUT VOLTAGE	MAX. OUTPUT CURRENT	MAX. OUTPUT POWER	TYPICAL EFFICIENCY
0RQP-E0T12AG 0RQP-E0T12BG	12 VDC	36 – 75 VDC	66.8A	800 W	95.5% @ 48 Vin

PART NUMBER EXPLANATION

0	R	QP	-	E0	T	12	x	G
Mounting Type	RoHS Status	Series Name		Output Power	Input Range	Output Voltage	Logic and Optional Features	Package Type
Through hole mount	RoHS	QP (with Power management bus and Trim, sense)		800W	36 – 75 V	12 V	A- Active High, with baseplate B- Active Low, with baseplate	G – Tray package

2. ABSOLUTE MAXIMUM RATINGS

PARAMETER	DESCRIPTION	MIN	TYP	MAX	UNITS
Input Voltage	Continuous	-0.3	-	80	V
	Operating transient \leq 100 ms	-	-	100	
	Non- operating continuous	80	-	100	
Remote On/Off		-0.3	-	18	V
Current Sink		0	-	10	mA
Isolation Voltage	Input to output	-	-	2250	V
Operating Temperature	Ambient temperature	-40	-	85	°C
Storage Temperature		-55	-	125	°C
Altitude		-	-	5000	m

NOTE: Ratings used beyond the maximum ratings may cause a reliability degradation of the converter or may permanently damage the device.

3. INPUT SPECIFICATIONS

All specifications are typical at 25°C unless otherwise stated.

PARAMETER	DESCRIPTION	MIN	TYP	MAX	UNIT
Operating Input Voltage	Vin	36	48	75	V
Input Current (full load)	Iin	-	-	25	A
Input Current (no load)	Vin = 48 V	-	150	180	mA
Remote Off Input Current		-	15	20	mA
Input Reflected Ripple Current is (rms)	Vin = 48 V, Io = Iomax	-	50	70	mA
Input Reflected Ripple Current is (pk-pk)		-	150	-	mA
Under-voltage Turn on Threshold	Lockout turn on	33	35	36	V
Under-voltage Turn off Threshold	Lockout turn off, non-latching	31	33	35	V

CAUTION: This converter is not internally fused. An input line fuse must be used in application. Recommended input fast-acting fuse on system board.

4. OUTPUT SPECIFICATIONS

All specifications are typical at nominal input, full load at 25°C unless otherwise stated.

PARAMETER	DESCRIPTION	MIN	TYP	MAX	UNIT
Output Voltage Set Point	Test condition of the output set point: Vin = 48 V, Io = 50% load at 25°C ambient	11.97	12.00	12.03	V
Output Voltage Regulation	(Over all operating input voltage, resistive load, and temperature conditions until end of life)	11.76	12.00	12.24	V
Output Voltage Regulation					
Load Regulation	Io = 0~100 % load	-	20	40	mV
Line Regulation	Vin = 36 ~ 75 V	-	20	60	mV
Regulation Over Temperature		-	150	200	mV
Output Ripple and Noise (pk-pk)	Vin = 48 V, Io = 100% load at 25°C ambient, 20 MHz BW, Cext = 3*1000 µF / 16 V (OS-CON) + 1 µF / 16 V (Ceramic).	-	100	200	mV
Output Ripple and Noise (rms)		-	35	70	mV
Output Current Range		0	-	66.8	A
Output DC Current Limit	Hiccup mode	72	75	77	A
Rise Time	Trise = Time for Vo to rise from 10% to 90% of Vo,set	-	25	-	ms
Turn-On Delay	Tdelay = the time from Vin enabled to Vo = 10%* Vo,set	-	-	50	ms
	Tdelay = the time from on/off enabled to Vo =10%* Vo,set	-	-	50	
Overshoot at Turn on		-	0	3	%
Undershoot at Turn off		-	0	3	%
Output Capacitance	Typically, 25% ceramic and 75% solid electrolytic capacitor.	3000	-	10000	µF
Transient Response					
ΔV 50%~75% of Max Load		-	250	400	mV
Settling Time	di/dt = 1A/µs, Vin = 48 VDC, Ta = 25 °C, Tested with Cext = 3*1000 µF / 16 V (OS-CON) + 1 µF / 16 V (Ceramic).	-	700	-	us
ΔV 75%~50% of Max Load		-	250	400	mV
Settling Time		-	700	-	µs

5. GENERAL SPECIFICATIONS

PARAMETER	DESCRIPTION	MIN	TYP	MAX	UNIT
Efficiency	Io = 100% Irate	--	95.5	-	%
	Io = 60% Irate	--	95.9	-	%
Switching Frequency		-	260	-	kHz
MTBF	Calculated Per Bell Core SR-332	-	5.50	-	M hrs
FIT	(Vin = 48 V, Vo = 12 V, Io = 80 % Iomax A, Ta = 40°C, Airflow = 500 LFM, FIT = 10 ⁹ /MTBF)	-	181.87	-	10 ⁹ /Hours
Over Temperature Protection		-	140	-	°C
Output Voltage Trim Range	For all operating input voltage	9	-	12.6	V
Over Voltage Protection (Static)	Latching mode	13.5	-	13.8	V
Weight		-	76	-	g
Dimensions (L x W x H)	For base plate version		2.30 x 1.45 x 0.51 58.42 x 36.83 x 13.00		inch mm
Isolation Characteristics					
Input to Output		-	-	2250	VDC
Input to Heatsink		-	-	2250	VDC
Output to Heatsink		-	-	500	VDC
Isolation Resistance		10M	-	-	Ohm
Isolation Capacitance		-	-	3300	pF

6. EFFICIENCY DATA

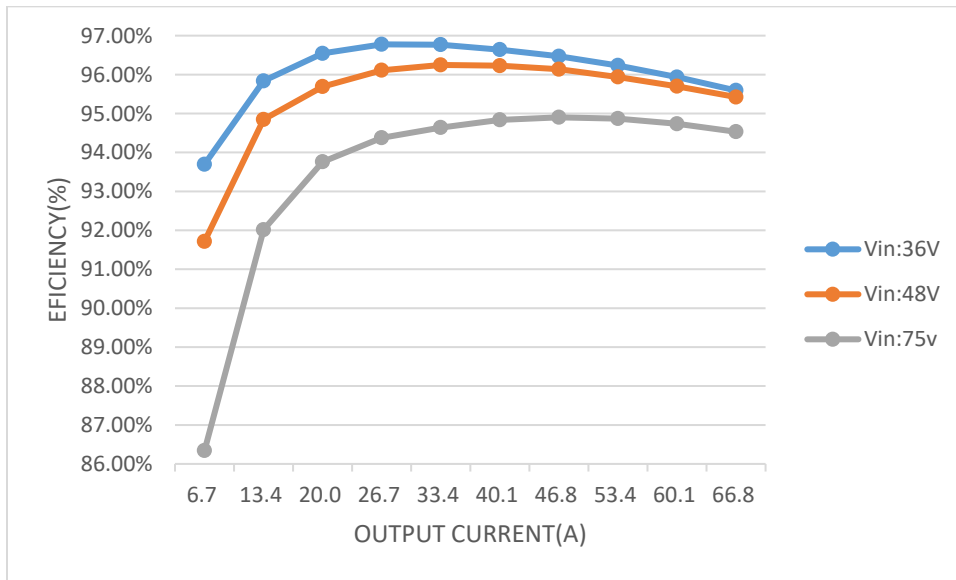

Figure 1. Efficiency data

7. REMOTE ON/OFF

PARAMETER	DESCRIPTION		MIN	TYP	MAX	UNIT
Signal Low (Unit Off)	Active High	Remote On/Off pin is open, the module is on	-0.3	-	0.8	V
Signal High (Unit On)			2.4	-	18	V
Signal Low (Unit On)	Active Low	Remote On/Off pin is open, the module is off	-0.3	-	0.8	V
Signal High (Unit Off)			2.4	-	18	V
Current Sink			0	-	1	mA

RECOMMENDED REMOTE ON/OFF CIRCUIT FOR ACTIVE HIGH

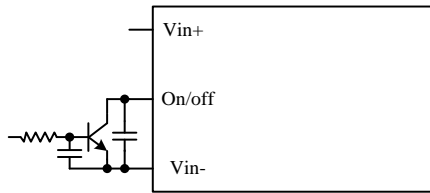

Figure 2. Control with open collector/drain circuit

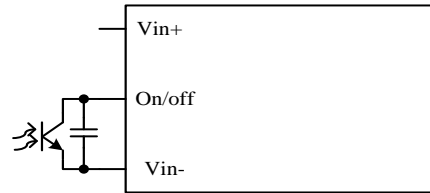

Figure 3. Control with photocoupler circuit

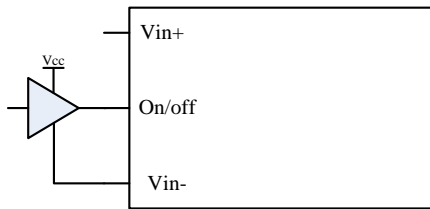

Figure 4. Control with logic circuit

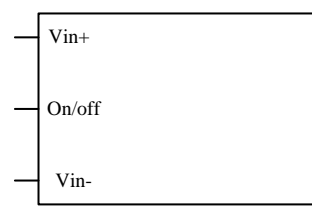

Figure 5. Permanently on

RECOMMENDED REMOTE ON/OFF CIRCUIT FOR ACTIVE LOW

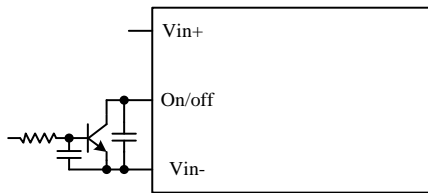

Figure 6. Control with open collector/drain circuit

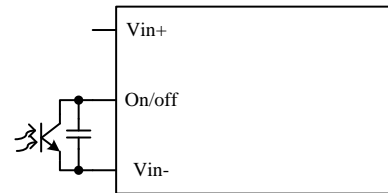

Figure 7. Control with photocoupler circuit

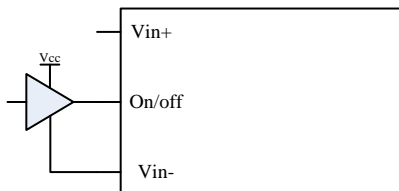

Figure 8. Control with logic circuit

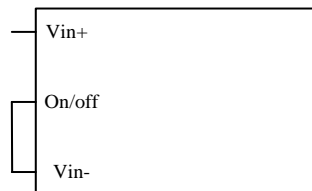

Figure 9. Permanently on

8. OUTPUT TRIM EQUATIONS

Equations for calculating the trim resistor are shown below. The Trim Down resistor should be connected between the Trim pin and Sense (-) pin. The Trim Up resistor should be connected between the Trim pin and the Sense (+). Only one of the resistors should be used for any given application.

TRIM DOWN TEST CIRCUIT

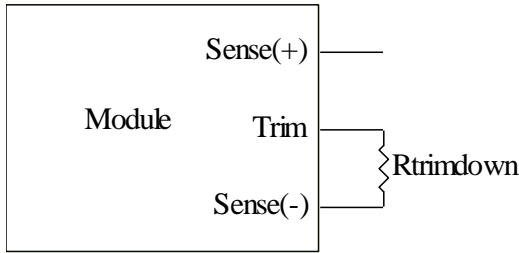

Figure 10. Trim down test circuit

$$R_{trimdown} = \frac{511}{|\delta|} - 10.22 [k\Omega]$$

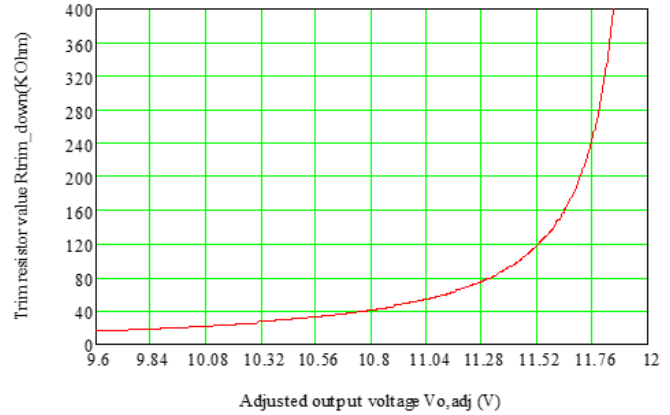

Figure 11. Trim down curve

TRIM UP TEST CIRCUIT

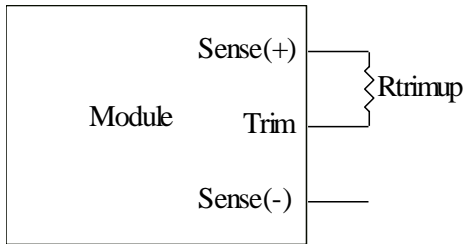

Figure 12. Trim up test circuit

$$R_{trimup} = \frac{(100 + \delta) \cdot V_o \cdot 5.11 - 626}{1.225 \cdot \delta} - 10.22 [k\Omega]$$

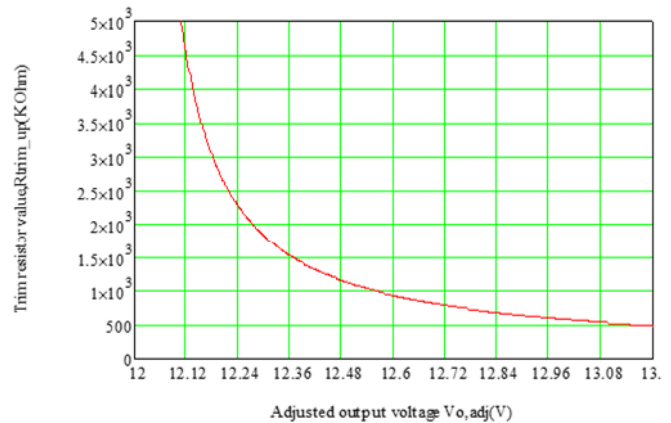

Figure 13. Trim up curve

Note:

Vo_req = Desired (trimmed) output voltage [V].

Output voltage Vo = 12 V.

$$\delta = \frac{(V_o_{req} - V_o)}{V_o} \times 100 [\%]$$

Note:

1 The trim used the VOUT_COMMAND of POWER MANAGEMENT BUS and the trim used the function of trim pin (6 pin) cannot be used at the same time.

2 If use VOUT_COMMAND of POWER MANAGEMENT BUS to trim Vout set point, then the function of trim pin (6 pin) will be disabled immediately. And if need enable the function of trim pin(6pin) to trim Vout set point again, should turn off and turn on the input voltage of module to restart module.

9. REMOTE SENSE

This module has remote sense compensation feature. It can minimize the effects of resistance between module's output and load in system layout and facilitates accurate voltage regulation at load terminals or other selected point.

1. Recommend the connection of remote sense compensation as below figure. There are a resistor RS+ (100 ohm) from Vo+ to Sense+ and a resistor RS- (100 ohm) from Vo- to Sense- inside of this module.

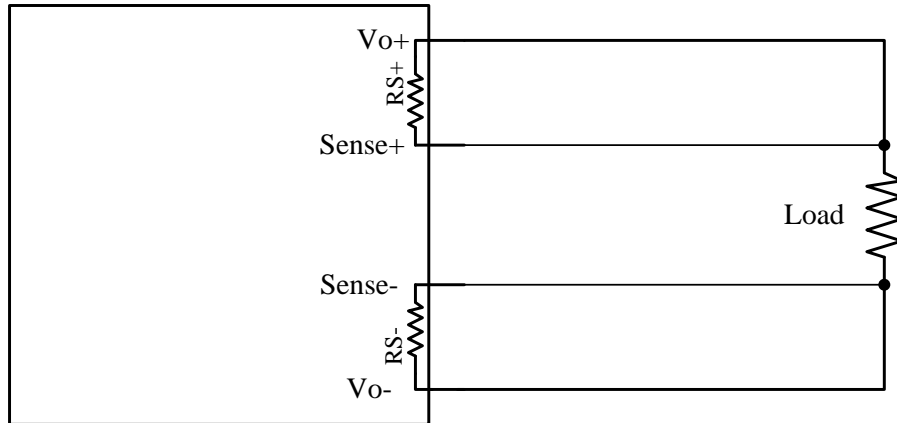

Figure 14.

2. If not using remote sense compensation, please connect sense directly to output at module's pin, that is, connect sense+ to Vo+ and sense- to Vo- at module's pin, the shorter the better. See below figure.

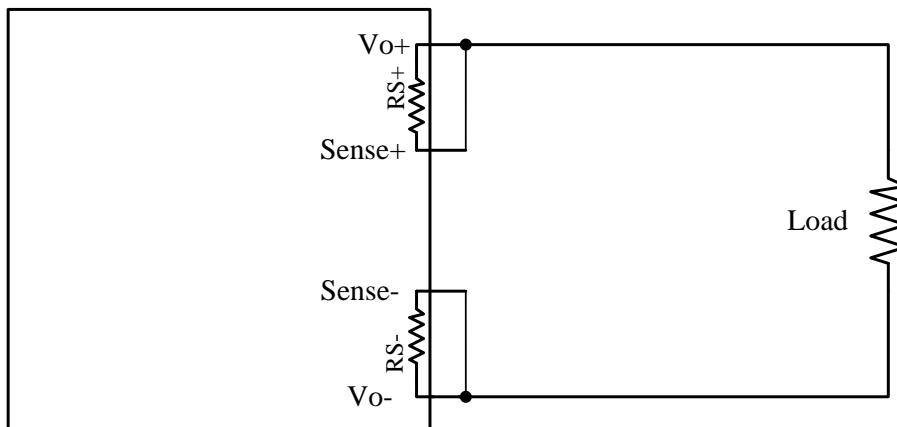

Figure 15.

10. INPUT NOISE

Input reflected ripple current.

TESTING SETUP

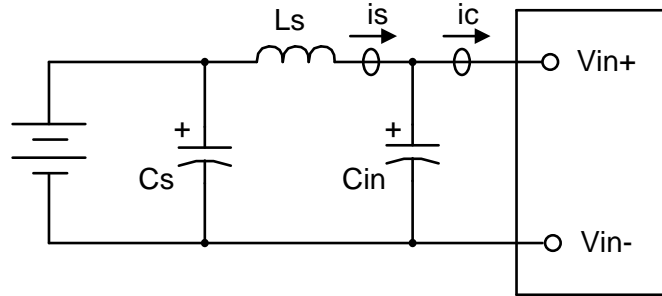

Figure 16. Test setup

Notes and values in testing.

is: Input Reflected Ripple Current

ic: Input Terminal Ripple Current

Ls: Simulated Source Impedance (10µH)

Cs: NIL

Cin: Electrolytic capacitor, should be as closed as possible to the power module to swallow ic ripple current and help with stability. Recommendation: 220 µF*2, ESR < 0.1Ω @ 100 kHz, 20 °C.

Below measured waveforms are based on above simulated and recommended inductance and capacitance.

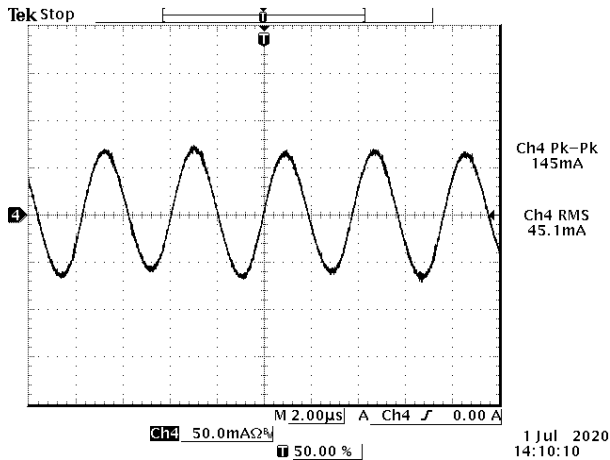

Figure 17. is (input reflected ripple current), AC component

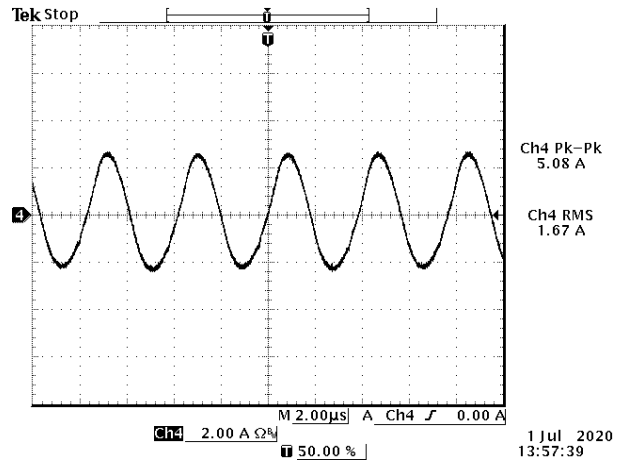

Figure 18. ic (input terminal ripple current), AC component

Test condition: 48 VDC input, 12 VDC / 66.8 A output and Ta = 25 °C

11. RIPPLE AND NOISE WAVEFORM

TESTING SETUP

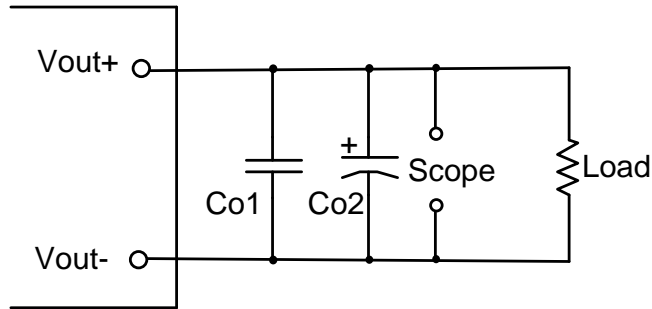

Figure 19.

Notes and values in testing.

Co1: 1 μ F ceramic capacitor

Co2: 3000 μ F OS-CON capacitor

The capacitor should be as closed as possible to the power module to swallow ripple current and help with stability. Below measured waveforms are based on above capacitance.

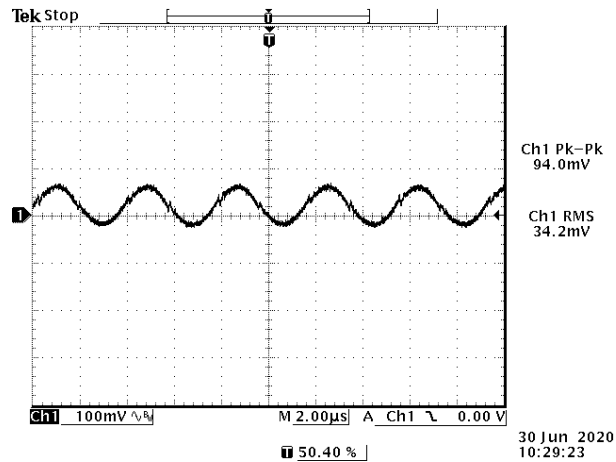

Figure 20. Ripple and noise waveform

Note: 48 VDC input, 12 VDC / 66.8 A output and $T_a = 25^\circ\text{C}$, $C_{ext} = 3 \times 1000 \mu\text{F} / 16 \text{ V (OS-CON)} + 1 \mu\text{F} / 16 \text{ V (Ceramic)}$.

12. TRANSIENT RESPONSE WAVEFORMS

Transient Response test condition: $di/dt = 1 \text{ A}/\mu\text{s}$, $C_{\text{ext}} = 3 \times 1000 \mu\text{F} / 16 \text{ V (OS-CON)} + 1 \mu\text{F} / 16 \text{ V (Ceramic)}$.

CHI: Vout, CH4: Iout

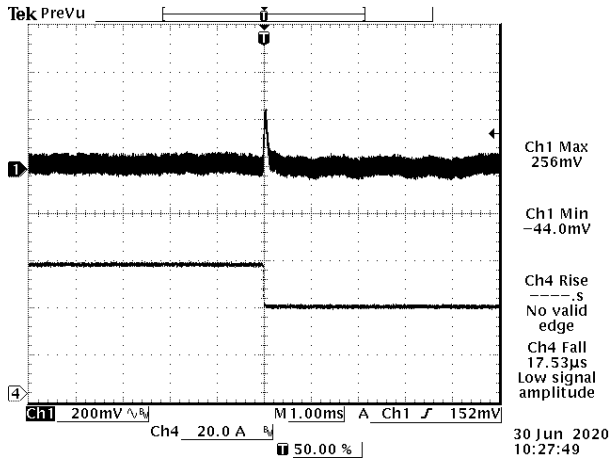

Figure 21. Vout = 12 V 75%-50% Load Transients at Vin = 48 V, Ta = 25 °C

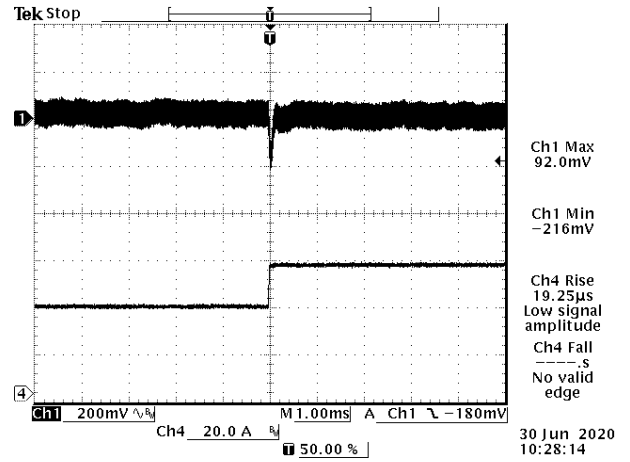

Figure 22. Vout = 12V 50%-75% Load Transients at Vin = 48 V, Ta = 25 °C

13. STARTUP & SHUTDOWN

STARTUP

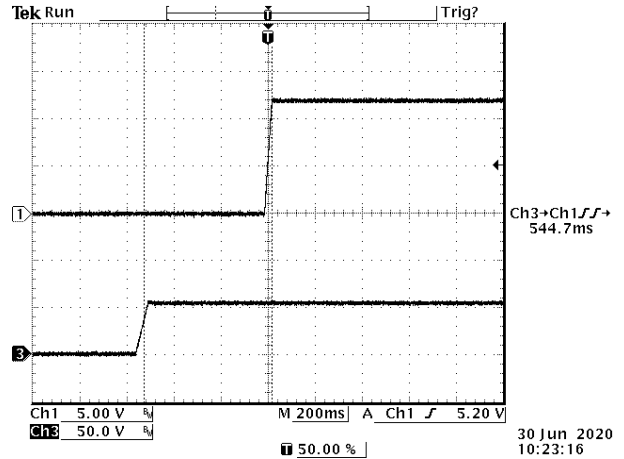
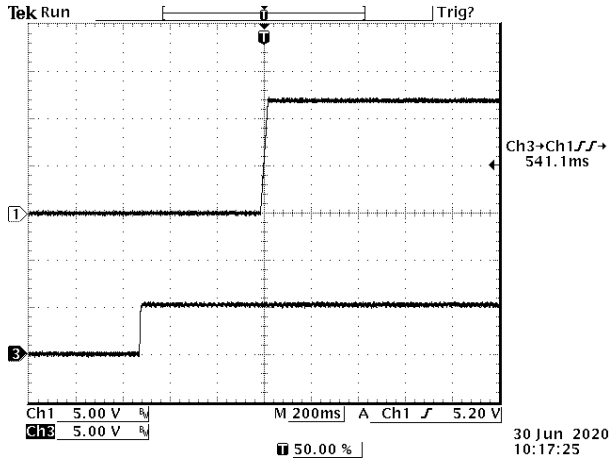

Figure 23. 48 VDC input, 12 VDC / 66.8 A output and $T_a = 25\text{ }^\circ\text{C}$,
 $C_{ext} = 3 \times 1000\text{ }\mu\text{F} / 16\text{ V (OS-CON)} + 1\text{ }\mu\text{F} / 16\text{ V (Ceramic)}$
 CH1: Vout, CH3: Remote on/off (Active high)

Figure 24. 48 VDC input, 12 VDC / 66.8 A output and $T_a = 25\text{ }^\circ\text{C}$,
 $C_{ext} = 3 \times 1000\text{ }\mu\text{F} / 16\text{ V (OS-CON)} + 1\text{ }\mu\text{F} / 16\text{ V (Ceramic)}$
 CH1: Vout, CH3: Vin

SHUTDOWN

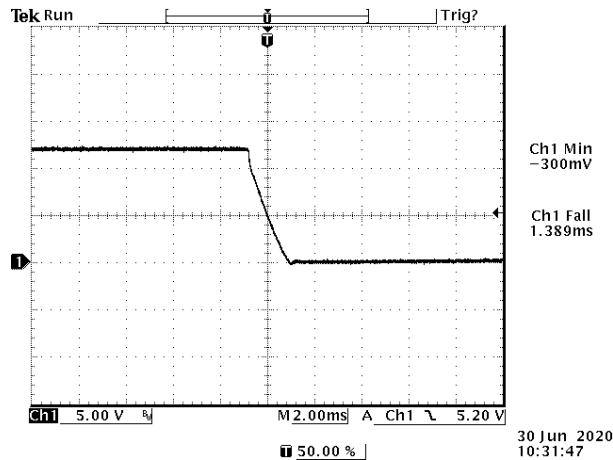

Figure 25. 48 VDC input, 12 VDC / 66.8 A output and $T_a = 25\text{ }^\circ\text{C}$,
 $C_{ext} = 3 \times 1000\text{ }\mu\text{F} / 16\text{ V (OS-CON)} + 1\text{ }\mu\text{F} / 16\text{ V (Ceramic)}$
 CH1: Vout



Asia-Pacific
 +86 755 298 85888

Europe, Middle East
 +353 61 225 977

North America
 +1 408 785 5200

14. UNDER VOLTAGE LOCKOUT

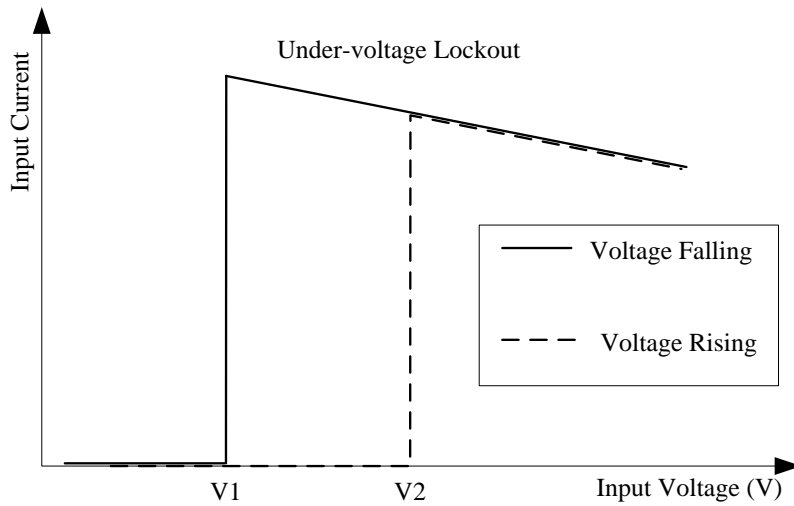

Figure 26. Under voltage lockout: $V_1 = 33\text{ V}$, $V_2 = 35\text{ V}$

15. THERMAL DERATING CURVES

THERMAL TEST SETUP

A module in electronic cards is typically located in a busy area without redundant space around it. To simulate a real condition and avoid turbulence we add a cover with defined dimensions.

The distance has to be 6.35 mm (0.25 in) from the top of the module and 6.35 mm (0.25 in) on the left and right side of the module. The values reflect most of the real applications and it is a common procedure in the power module market.

Ambient temperature and airflow are measured in front of the module at the distance of 76.2 mm (3 in).

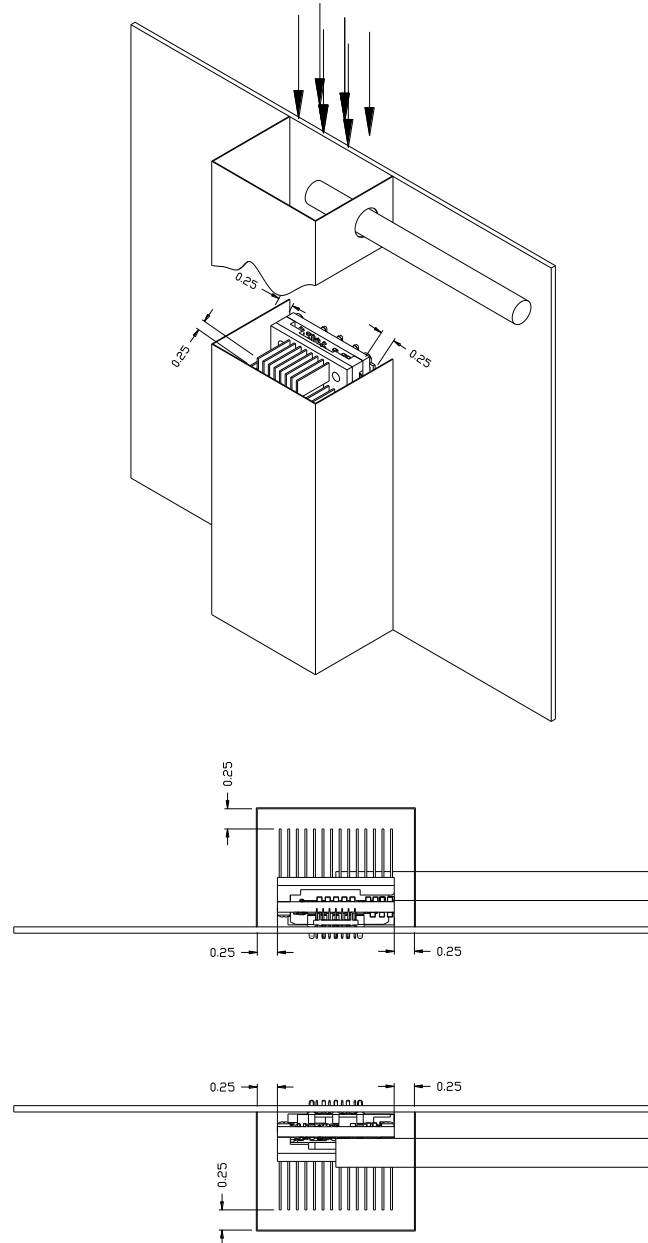

Figure 27. ORQP-E0T12 + External heatsink

Tests setup drawing and all measures are in inches.

*The size of external heatsink is 2.30"×1.45"×0.7".

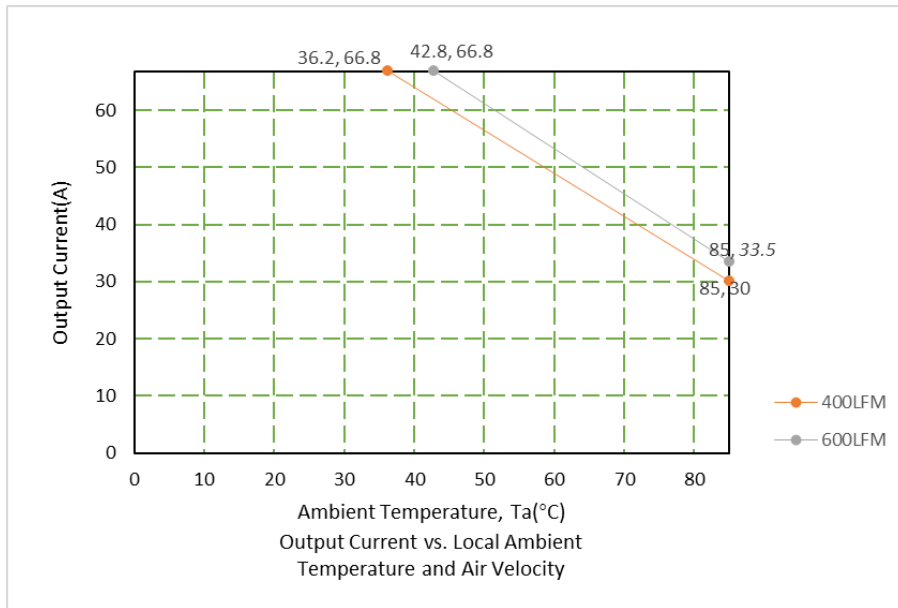

Figure 28. Thermal derating curve @ Vin = 48 V

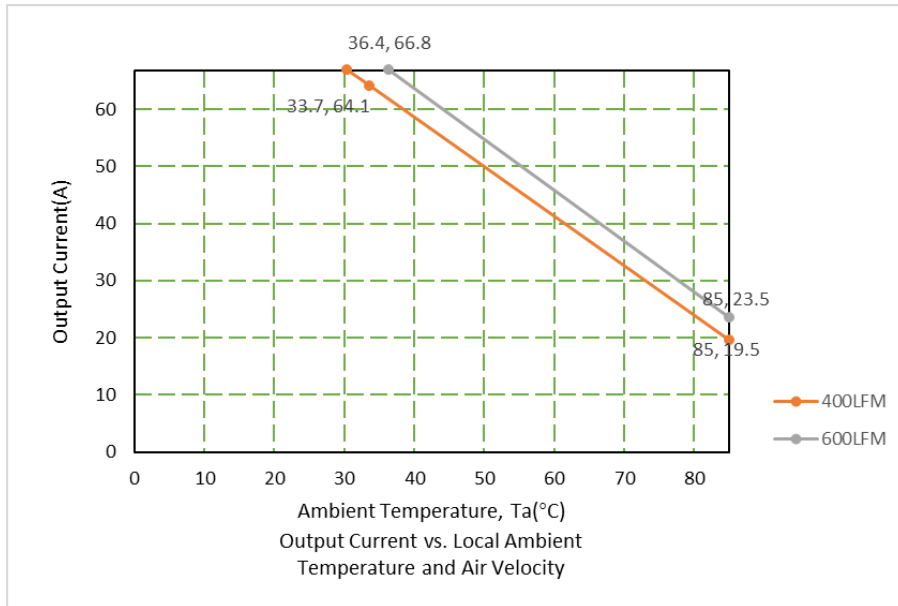

Figure 29. Thermal derating curve @ Vin = 75 V

16. SAFETY & EMC

SAFETY:

1. CSA u/cs Certification UL/CSA 62368-1
2. CB Certification IEC/EN 62368-1
3. CB Certification IEC/EN 60950-1
4. Nemko Certification EN 62368-1

EMC:

Compliance to EN 55032 class B (both peak and average) with the following inductive and capacitive filter.

SETUP:

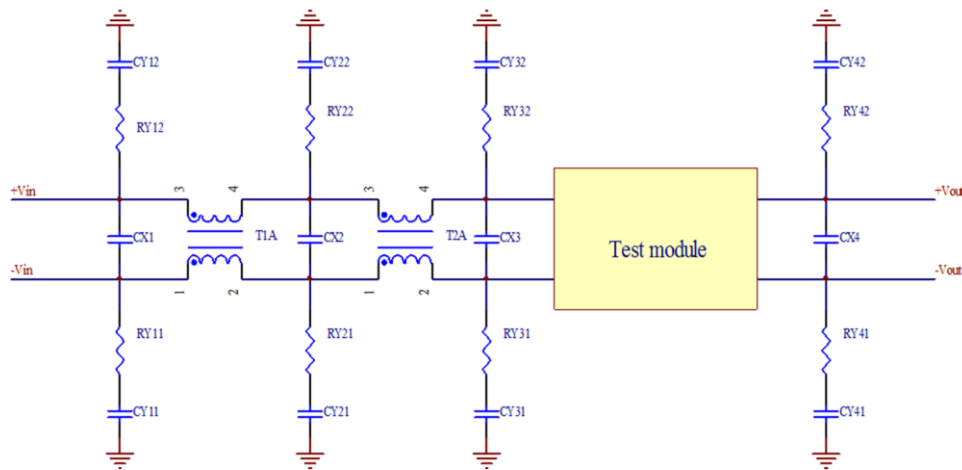

Figure 30.

T1A	CX1	RY11	RY12	CY11	CY12
1mH	10μF	-	-	4700pF	4700pF
T2A	CX2	RY21	RY22	CY21	CY22
2.5mH	10μF	-	-	2200pF	2200pF
-	CX3	RY31	RY32	CY31	CY32
-	10μF	-	-	4700pF	4700pF
-	CX4	RY41	RY42	CY41	CY42
-	-	-	-	-	-

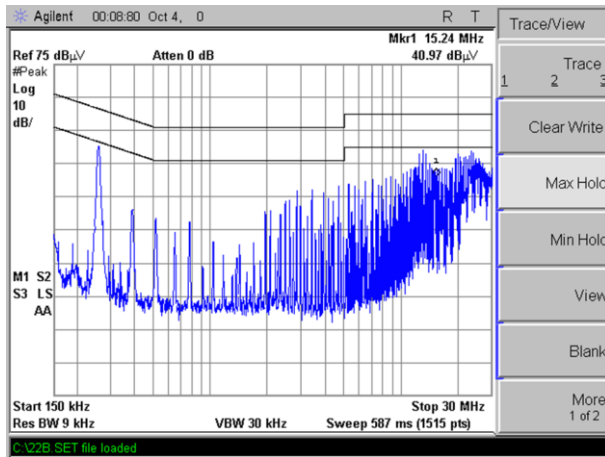

Figure 31. Positive

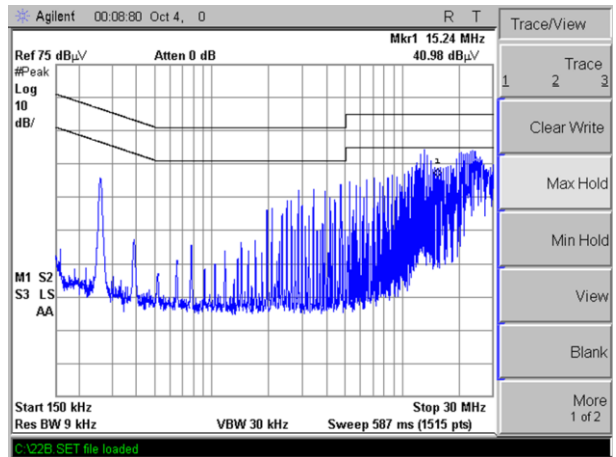

Figure 32. Negative

17. POWER MANAGEMENT BUS

POWER MANAGEMENT BUS DIGITAL FEATURE DESCRIPTION

The module supports Power Management Bus to allow to be monitored, controlled and configured by the system. More detailed Power Management Bus information can be found in the Power Management Bus Power Management Protocol Specification, Part I and part II, revision 1.3, which is shown in the System Management Interface Forum Web site: www.powerSIG.org. The supported Power Management Bus commands of the module are listed below in the supported POWER MANAGEMENT BUS COMMANDS section. The module supports four Power Management Bus signal lines: Data, Clock, SMBALERT (optional), Control (C2 pin, optional), and two Address lines: Addr0 and Addr1.

SMBALERT protocol is also supported by the module. SMBALERT line is also a wired-AND signal, by which the module can alert the POWER MANAGEMENT BUS master via pulling the SMBALERT pin to an active low. There is only one way that the master and the module response to the alert of SMBALERT line. The master will communicate with the slave module using the programmed address and using the various READ_STATUS commands to find the cause for the SMBALERT. The CLEAR_FAULTS command will clear the SMBALERT.

The module contains a data flash used to store configuration settings, which will not be programmed into the device data flash automatically. The STORE_DEFAULT_ALL can be used to store the current settings to the non-volatile memory. The RESTORE_DEFAULT_ALL can be used to restore the factory settings to the non-volatile memory.

The module also supports the Packet Error Checking (PEC) protocol. It can check the PEC byte provided by the Power Management Bus master and include a PEC byte in all message transmitted back to the master.

POWER MANAGEMENT BUS ADDRESSING

The Module has flexible POWER MANAGEMENT BUS addressing capability. When connect different resistor from Addr0 and Addr1 pin to GND pin, 64 possible addresses can be acquired. The address is in the form of octal digits; Each pin offers one octal digit, and then combine together to form the decimal address as shown in below.

$$\text{Address} = 8 * \text{ADDR1} + \text{ADDR0}$$

Corresponded to each octal digit, the requested resistor values are shown below, and +/-1% resistors accuracy can be accepted. If there are any resistances exceeding the requested range, address 64 will be return. 0-12 and 40, 44, 45, and 55 in decimal address cannot be used, since they are reserved according to the SMBus specifications, and which will also return address 16.

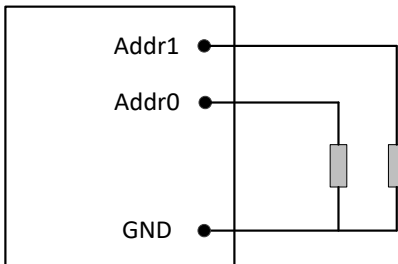

Octal Digit	Resistor (kOhm)
0	10
1	15.4
2	23.7
3	36.5
4	54.9
5	84.5
6	130
7	200

NOTE: Power Management Bus communication is only supported when vin normal and remote on.

POWER MANAGEMENT BUS DATA FORMAT

For commands which is except to the output voltage, including input voltage, output current, temperature, PWM frequency, duty cycle, the controller will use the 2-byte linear format as defined by the Power Management Bus system management protocol. The linear data format contains 2 bytes which include a 5-bit two's complement exponent and an 11-bit two's complement mantissa as below. The transmitted value Y is reported as the form $Y = X \cdot 2^N$.

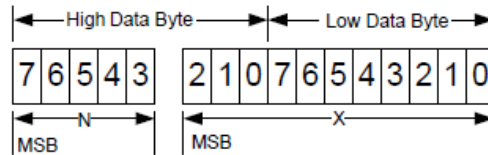

For example, to set the over temperature fault threshold 135 deg C by OT_FAULT_LIMIT command, the read/write data can be calculated refer to below: the binary number of N is 0, whose decimal number is 0.

$X = \text{TOTP}/2(0) = 135$, whose binary is 0b00010000111.

Combine X and N, the binary is 0b0000000010000111. The hexadecimal of OT_FAULT_LIMIT is 0x0087.

The output voltage parameters use the Power Management Bus Vout linear format. The data format is shown below.

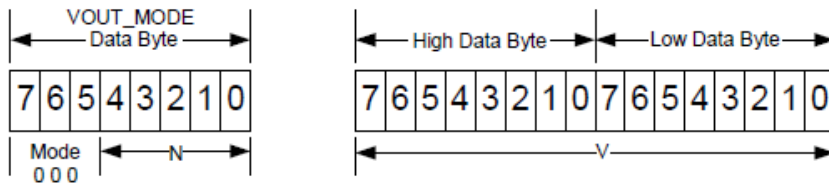

The voltage will be in the form $\text{Voltage} = V \cdot 2^N$. The Mantissa and exponent in this equation will be read and reported using 3 bytes. The first byte is the VOUT_MODE byte which will always contain 000 in the 3 MSB's. The 5 LSB's are the exponent. The exponent N is fixed and equals -10. The other 2 bytes N will contain the Mantissa. In the above format N is a 5-bit two's complement binary integer and V is a 16-bit unsigned binary integer. All 16 bits are reported to be compatible with the Power Management Bus protocol.

For example, to set Vout to 12V by VOUT_COMMAND, the read/write data can be calculated refer to below process:

$$V = \text{Vout}/2^{(-10)} = 12/2^{(-10)} \approx 12288$$

Convert the decimal to hexadecimal format is 0x3000. So the VOUT_COMMAND is 0x3000.

SUPPORTED POWER MANAGEMENT BUS COMMANDS

The main Power Management Bus commands described in the Power Management Bus 1.3 specification are supported by the module. Partial Power Management Bus commands are fully supported; Partial Power Management Bus commands have difference with the definition in Power Management Bus 1.3 specification. All the supported Power Management Bus commands are detailed summarized in the below table.

COMMAND	CODE	COMMAND DESCRIPTION	TYPE	DATA FORMAT	DEFAULT VALUE	DATA UNITS	NOTE
OPERATION	0x01	Configures the operational state of the module	R/W byte	Bit field	0x80	/	1
ON_OFF_CONFIG	0x02	Configures the combination of CONTROL pin input and serial bus commands needed to turn the module on and off	Read byte	Bit field	0x18	/	1, 2
CLEAR_FAULTS	0x03	Clear any fault bits that have been set	Send byte	/	/	/	/
RESTORE_DEFAULT_ALL	0x12	Restore the factory settings to the non-volatile memory	Write	/	/	/	5
STORE_USER_ALL	0x15	Store the current settings to the non-volatile memory	Write	/	/	/	5
VOUT_MODE	0x20	Vo data format	Read byte	mode + exponent	0x16	/	/
VOUT_COMMAND	0x21	Set the output voltage normal value	R/W word	Vout linear	12	Volts	/
VOUT_MAX	0x24	Set an upper limit on the output voltage the module can command	Read word	Vout linear	12.6	Volts	/
VOUT_MARGIN_HIGH	0x25	Set the output voltage margin high value	Read word	Vout linear	12.5	Volts	/
VOUT_MARGIN_LOW	0x26	Set the output voltage margin low value	Read word	Vout linear	10	Volts	/
VOUT_MIN	0x2B	Set a lower limit on the output voltage the module can command	Read word	Vout linear	8	Volts	/
MAX_DUTY	0x32	Set the maximum duty cycle	Read word	Linear	50	%	/
FREQUENCY_SWITCH	0x33	Set the primary side switching frequency	Read word	Linear	130	kHz	/
VOUT_OV_FAULT_LIMIT	0x40	Set the output over voltage fault threshold	R/W word	Vout linear	13.5	Volts	4
VOUT_OV_FAULT_RESPONSE	0x41	Instructs what action to take in response to an output overvoltage fault	R/W byte	Bit field	0x80	/	1
IOUT_OC_FAULT_LIMIT	0x46	Set the output overcurrent fault threshold	R/W word	Linear	75	A	3, 4
IOUT_OC_FAULT_RESPONSE	0x47	Instructs what action to take in response to an output overcurrent fault	R/W byte	Bit field	0xF8	/	1
OT_FAULT_LIMIT	0x4F	Set the over temperature fault threshold	R/W word	Linear	135	Deg C	3, 4
OT_FAULT_RESPONSE	0x50	Instructs what action to take in response to an over temperature fault	R/W byte	Bit field	0xB8	/	1
MFR_C1_C2_CONFIG	0x6C	Configure C2 pin function	R/W byte	Bit field	0x00	/	1
MFR_C2_CONFIG	0x6D	Configure C2 pin logic	R/W byte	Bit field	0x00	/	1
MFR_PGOOD_POLARITY	0x6E	Configure power good logic	R/W byte	Bit field	0x01	/	1
STATUS_WORD	0x79	Returns the information with a summary of the unit's fault condition	Read word	Bit field	0	/	1, 6
STATUS_VOUT	0x7A	Returns the information with a summary of the unit's output voltage condition	Read byte	Bit field	0	/	1, 6
STATUS_IOUT	0x7B	Returns the information with a summary of the unit's output current condition	Read byte	Bit field	0	/	1, 6
STATUS_TEMPERATURE	0x7D	Returns the information with a summary of the unit's temperature condition	Read byte	Bit field	0	/	1, 6
STATUS_CML	0x7E	Returns the information with a summary of the unit's communication condition	Read byte	Bit field	0	/	1, 6
READ_VIN	0x88	Returns the input voltage of the module	Read word	Linear	/	Volts	/
READ_VOUT	0x8B	Returns the output voltage of the module	Read word	Vout Linear	/	Volts	/
READ_IOUT	0x8C	Returns the output current of the module	Read word	Linear	/	A	/
READ_TEMPERATURE_1	0x8D	Returns the temperature of the module	Read word	Linear	/	Deg C	/
READ_PIN	0x97	Returns the input power of the module	Read word	Linear	/	Watts	/
POWER MANAGEMENT BUS_REVISION	0x98	Reads the revision of the Power Management Bus	Read byte	Bit field	0x33	/	1
MFR_ID	0x99	Reads the ID of the manufature	Read block	ASCII	BELF	/	/
FIRMWARE_REV	0x9B	Reads the revision of the firmware	Read block	ASCII	/	/	7

NOTES:

1. Refer to below detailed description.
2. OPERATION command controls module on/off
3. Before write operation, it is necessary to read the register data and parse out the corresponding linear format N value, then convert write value based on N.
4. In order to ensure that the product works properly, the adjustment range of the protection limit value is limited, when the set value exceeds the upper or lower limits, the lower limit value is automatically set. The following table shows the upper and lower limits.

COMMAND	CODE	THE LOW LIMIT	THE UPPER LIMIT
VOUT_OV_FAULT_LIMIT	0x40	13.2	14
IOUT_OC_FAULT_LIMIT	0x46	43	80
OT_FAULT_LIMIT	0x4F	120	140

5. Read or write this command, PSU will shut down until next vin power cycle
6. ALL the fault bits set in all the status registers remain set, even if the fault condition is removed or corrected, until one of the following occur:
 - (i) A remote off then remote on cycle
 - (ii) The device receives a CLEAR_FAULTS command
 - (iii) Vin power is removed from the module.
7. Two byte count command, value varies according to software version,

OPERATION (0x01)				
BIT NUMBER	PURPOSE	BIT VALUE	MEANING	DEFAULT SETTINGS
7	Turn the module on/off	1	on	1
		0	off	
6	Not supported	/	/	/
5:4	Control the source of the output voltage command	00	VOUT_COMMAND	00
		01	VOUT_MARGIN_LOW	
		10	VOUT_MARGIN_HIGH	
		11	Not supported	
3:0	Reserved or Not supported	/	/	/

ON_OFF_CONFIG (0x02)				
BIT NUMBER	PURPOSE	BIT VALUE	MEANING	DEFAULT SETTINGS
7:5	Reserved	/	/	/
4	Module powers up regardless of the state of the CONTROL pin and OPERATION command or not	0	Not supported	1
		1	Wait CONTROL and OPERATION	
3	Module powers up regardless of the state of the OPERATION command or not	0	Not supported	1
		1	Wait OPERATION command	
2	Module powers up regardless of the state of the CONTROL pin or not (Not supported)	0	Not supported	0
		1	Wait CONTROL pin	
1:0	Not supported	/	/	/

VOUT_OV_FAULT_RESPONSE (0x41)				
BIT NUMBER	PURPOSE	BIT VALUE	MEANING	DEFAULT SETTINGS
7:6	Response when fault happens	00	Not supported	10
		01	Not supported	
		10	The module shuts down and response according to the retry setting in bits [5:3]	
		11	Not supported	
5:3	Retry setting	000	Module does not attempt to restart until a RESET signal or OPERATION command, or Bias power is removed	000
		001-110	Not supported	
		111	Attempts to restart continuously until it is commanded off	
2:0	Delay time	/	Not supported	/

IOUT_OC_FAULT_RESPONSE (0x47)				
BIT NUMBER	PURPOSE	BIT VALUE	MEANING	DEFAULT SETTINGS
7:6	Response when fault happens	00	Not supported	11
		01	Not supported	
		10	Not supported	
		11	The module shuts down and response according to the retry setting in bits [5:3]	
5:3	Retry setting	000	Module does not attempt to restart until a RESET signal or OPERATION command or Bias power is removed	111
		001-110	Not supported	
		111	Attempts to restart continuously until it is commanded off	
2:0	Delay time	/	Not supported	/

OT_FAULT_RESPONSE (0x50)				
BIT NUMBER	PURPOSE	BIT VALUE	MEANING	DEFAULT SETTINGS
7:6	Response when fault happens	00	Not supported	10
		01	Not supported	
		10	The module shuts down and response according to the retry setting in bits [5:3]	
		11	Not supported	
5:3	Retry setting	000	Module does not attempt to restart until a RESET signal or OPERATION command or Bias power is removed	111
		001-110	Not supported	
		111	Attempts to restart continuously until it is commanded off	
2:0	Delay time	/	Not supported	/

MFR_C1_C2_CONFIG (0x6C)				
BIT NUMBER	PURPOSE	BIT VALUE	MEANING	DEFAULT SETTINGS
7:4	Reserved	/	/	/
3:0	Pin configuration	0000	C2 pin: POWER_GOOD	0000
		0010	C2 pin: ON/OFF (Secondary)	



Asia-Pacific
+86 755 298 85888

Europe, Middle East
+353 61 225 977

North America
+1 408 785 5200

MFR_C2_CONFIG (0x6D)				
BIT NUMBER	PURPOSE	BIT VALUE	MEANING	DEFAULT SETTINGS
7:2	Reserved	/	/	/
1	ON/OFF Configuration	1	And- Primary and secondary side on/off	0
		0	C2 pin signal is ignored	
0	Secondary Side ON/OFF logic	1	Positive Logic (High level enable: input > 2.64V)	0
		0	Negative Logic (Low level enable: input < 0.66V)	

MFR_PGOOG_POLARITY (0x6E)				
BIT NUMBER	PURPOSE	BIT VALUE	MEANING	DEFAULT SETTINGS
7:1	Reserved	/	/	/
0	Power Good Logic	1	Positive PGOOD logic	1
		0	Negative PGOOD logic	

STATUS_WORD (0x79)				
HIGH BYTE				
BIT NUMBER	PURPOSE	BIT VALUE	MEANING	DEFAULT SETTINGS
7	VOUT	1	An output voltage fault has occurred	0
		0	Not occurred	
6	IOUT	1	An output current fault has occurred	0
		0	Not occurred	
5	INPUT (Not supported)	1	An input overvoltage fault has occurred	0
		0	Not occurred	
4	Not supported	/	/	/
3	Power_Good	1	Power_Good signal is negated	0
		0	Power_Good signal is ok	
2:1	Not supported	/	/	/
0	UNKNOWN	1	A fault type not given in bits [15:1] of the STATUS_WORD has been detected	0
		0	Not occurred	

STATUS_WORD (0x79)				
LOW BYTE				
BIT NUMBER	PURPOSE	BIT VALUE	MEANING	DEFAULT SETTINGS
7	Busy	1	A fault was declared because the device was busy and unable to respond	0
		0	Not occurred	
6	Off	1	This bit is asserted if the unit is not providing power to the output, regardless of the reason, including simply not being enabled	0
		0	Not occurred	
5	VOUT_OV_FAULT	1	An output overvoltage fault has occurred	0
		0	Not occurred	
4	IOUT_OC_FAULT	1	An output overcurrent fault has occurred	0
		0	Not occurred	
3	VIN_UV_FAULT (Not supported)	1	An input under voltage fault has occurred	0
		0	Not occurred	
2	TEMPERATURE	1	A temperature fault has occurred	0
		0	Not occurred	
1	CML	1	A communication, memory or logic fault has occurred	0
		0	Not occurred	
0	NONE_OF_THE_ABOVE	1	A fault not listed in bits [7:1] of this byte has occurred	0
		0	Not occurred	

STATUS_VOUT (0x7A)				
BIT NUMBER	PURPOSE	BIT VALUE	MEANING	DEFAULT SETTINGS
7	VOUT_OV_FAULT	1	Occurred	0
		0	Not occurred	
6:5	Not supported	/	/	/
4	VOUT_UV_FAULT	1	Occurred	0
		0	Not occurred	
3:0	Not supported	/	/	/

STATUS_IOUT (0x7B)				
BIT NUMBER	PURPOSE	BIT VALUE	MEANING	DEFAULT SETTINGS
7	IOUT_OC_FAULT	1	Occurred	0
		0	Not occurred	
6:0	Reserved or Not supported	/	/	/

STATUS_TEMPERATURE (0x7D)				
BIT NUMBER	PURPOSE	BIT VALUE	MEANING	DEFAULT SETTINGS
7	OT_FAULT	1	Occurred	0
		0	Not occurred	
6:0	Reserved or Not supported	/	/	/



Asia-Pacific
+86 755 298 85888

Europe, Middle East
+353 61 225 977

North America
+1 408 785 5200

STATUS_CML (0x7E)				
BIT NUMBER	PURPOSE	BIT VALUE	MEANING	DEFAULT SETTINGS
7	Invalid or unsupported command received	1	Occurred	0
		0	Not occurred	
6:0	Reserved or Not supported	/	/	/

POWER MANAGEMENT BUS_REVISION (0x98)				
BIT NUMBER	PURPOSE	BIT VALUE	MEANING	DEFAULT SETTINGS
7:4	Indicate the revision of Power Management Bus specification Part I to which the device is compliant	0000	1.0	0011
		0001	1.1	
		0010	1.2	
		0011	1.3	
3:0	Indicate the revision of Power Management Bus specification Part II to which the device is compliant	0000	1.0	0011
		0001	1.1	
		0010	1.2	
		0011	1.3	

18. MECHANICAL DIMENSIONS

OUTLINE

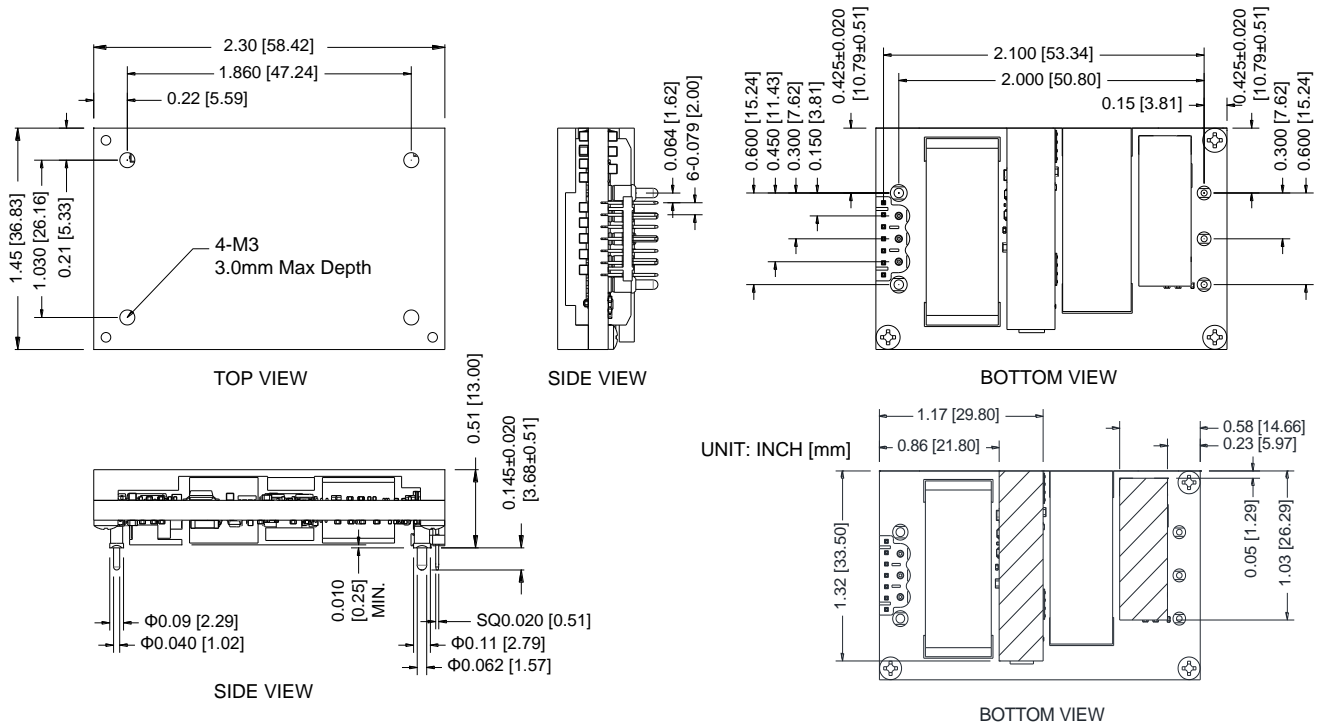

Figure 33. Outline

Note: This module is recommended and compatible with Pb-Free Wave Soldering and must be soldered using a peak solder temperature of no more than 260 °C for less than 5 seconds.

Note: All Pins: Material - Copper Alloy.
Finish - PIN 1/2/3/4/8 tin plated. Others gold plated.

- 1) Undimensioned components are shown for visual reference only.
- 2) All dimensions in inches; Tolerances: x.xx +/-0.02 in [0.5 mm]. x.xxx +/-0.010 in [0.25 mm]. Unless otherwise stated.

PIN DEFINITIONS

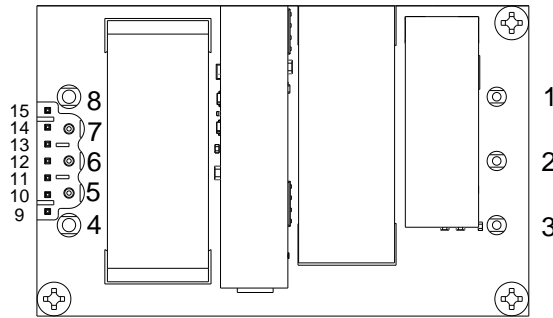

BOTTOM VIEW

Figure 34. Pins

PIN	DESCRIPTION	PIN	DESCRIPTION
1	Vin (+)	9	C2
2	ON/OFF	10	DGND
3	Vin (-)	11	PMBDATA
4	Vout (-)	12	SMBALERT
5	Sense (-)	13	PMBCLK
6	Trim	14	Addr1
7	Sense (+)	15	Addr0
8	Vout (+)		

RECOMMENDED PAD LAYOUT

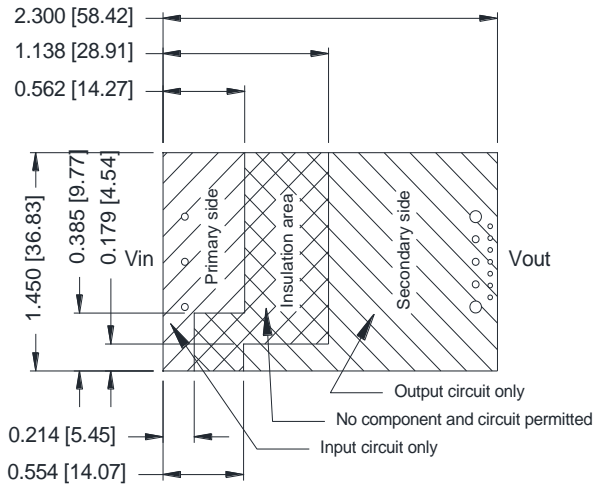

Figure 35. Recommended pad layout-1

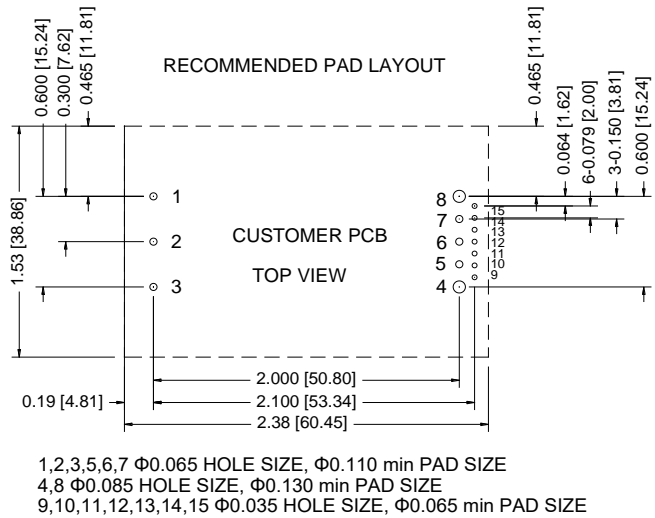

Figure 36. Recommended pad layout-2

19. REVISION HISTORY

DATE	REVISION	CHANGES DETAIL	APPROVAL
2018-11-14	AA	First release	Z.Tang
2019-03-15	AB	Second release, derating curve added, change mechanical dimension	Z.Tang
2019-11-11	AC	Update mechanical dimensions, power management bus and over temperature protection	J.Yao
2020-11-05	AD	Add new standard P/Ns to ORQP-E0T12 series. Update power management bus information.	H.Yu
2021-02-18	E	Update remote sense and EMC.	XF.Jiang

For more information on these products consult: tech.support@psbel.com

NUCLEAR AND MEDICAL APPLICATIONS - Products are not designed or intended for use as critical components in life support systems, equipment used in hazardous environments, or nuclear control systems.

TECHNICAL REVISIONS - The appearance of products, including safety agency certifications pictured on labels, may change depending on the date manufactured. Specifications are subject to change without notice.



Asia-Pacific
+86 755 298 85888

Europe, Middle East
+353 61 225 977

North America
+1 408 785 5200