

LTC7103-1 105V, 2.3A Low EMI Synchronous Step-Down Regulator

DESCRIPTION

Demonstration circuit 2833A is a 100V monolithic DC/DC step-down regulator featuring the [LTC[®]7103-1](#). The demo board is designed for a 5V/2.3A output from a 5V to 100V input operation at a 400kHz switching frequency. The wide input range makes it suitable for automotive, industrial, medical instrument, and telecom applications. This buck regulator has a peak efficiency of 93.5% at 12V_{IN}, 88.3% at 48V_{IN} and 81.5% at 100V_{IN} (see Figure 3).

The LTC7103-1 is a compact, high efficiency synchronous monolithic step-down switching regulator with fast current programming. The power switches, compensation network and other necessary circuits are inside of the LTC7103-1 to minimize external components and simplify design. The LTC7103-1 has wide operating range from 4.4V to 105V. A 40ns minimum on-time, together with 100% maximum duty cycle allow practical use at any output voltage between 1V and V_{IN}. The switching frequency can be programmed either via an oscillator resistor or an external clock over a 200kHz to 2MHz range. Additional features include a fast and accurate output current programming and monitoring, and ultralow EMI/EMC emissions.

The demo board has an EMI filter installed. The EMI performance of the board (with EMI filter) is shown in Figure 2. The figure shows that the circuit passes the

CISPR 25 radiated emission test with a wide margin. To achieve EMI/EMC performance as shown in Figure 2, the input EMI filter is required and the input voltage should be applied at +VIN_EMI turret pin.

The demo board provides current monitor and output clock signal to interface with an external application circuit. User selectable mode selection (JP1) is provided and Burst Mode[®] operation position is selected by default. Burst Mode operation increases light load efficiency while pulse-skipping mode allows constant-frequency operation to a lighter load. Forced continuous mode improves output voltage ripple at light load by allowing constant-frequency operation for entire range of output load. This demo board allows phase-locked loop (PLL) synchronization to an external clock by selecting SYNC mode on JP1 and by providing a clock signal on CLKIN turret.

The LTC7103-1 data sheet gives a complete description of the part, operation and application information. The data sheet must be read in conjunction with this demo manual for DC2833A. The LTC7103-1 is assembled in the 36 (26) lead QFN package. Proper board layout is essential for maximum thermal and electrical performance. See the data sheet sections for details.

[Design files for this circuit board are available.](#)

All registered trademarks and trademarks are the property of their respective owners.

PERFORMANCE SUMMARY Specifications are at T_A = 25°C

SYMBOL	PARAMETER	CONDITIONS	MIN	TYP	MAX	UNITS
V _{IN}	Input Supply Range		5		100	V
V _{OUT}	Output Voltage			5		V
I _{OUT}	Output Current Range, Continuous	Free Air	0		2.3	A
f _{SW}	Switching (Clock) Frequency			400		kHz
V _{OUTP-P}	Output Ripple	V _{IN} = 100V, V _{OUT} = 5V, I _{OUT} = 2.3A (20MHz BW)		50		mV _{P-P}
P _{OUT} /PIN	Efficiency	V _{IN} = 12V, I _{OUT} = 1A V _{IN} = 48V, I _{OUT} = 1A		92.6 88.1		% %
	Approximate Size	Component Area x Top Component Height		1.0 × 0.7 × 0.3		Inches

QUICK START PROCEDURE

Refer to Figure 1 for proper measurement equipment setup and follow the procedure below.

Note: When measuring the output voltage ripple, care must be taken to avoid a long ground lead on the oscilloscope probe. Measure the output voltage ripple by touching the probe tip and ground ring directly across the last output capacitor as shown in Figure 1.

1. Place SW1 to ON position.
2. With power off, connect the input power supply to +VIN_EMI and GND. If the EMI/EMC performance is not important, the input EMI filter can be bypassed by connecting the input power supply to +VIN and GND.
3. With power off, connect loads from +VOUT to GND.
4. Turn on the power at the input. Make sure that the input voltage does not exceeds 100V.

5. Check for the proper output voltage using a voltmeter. Output voltage should be within $5.0V \pm 0.1V$.

Note: If there is no output, temporarily disconnect the load to make sure that the load is not set too high.

6. Once the proper output voltage is established, adjust the load within the operating ranges and observe the output voltage regulation, ripple voltage, efficiency and other parameters.
7. An external clock can be added to the CLKIN terminal when SYNC mode is used (JP1 on the SYNC position). See the data sheet Frequency Selection and Phase-Locked Loop section for details.

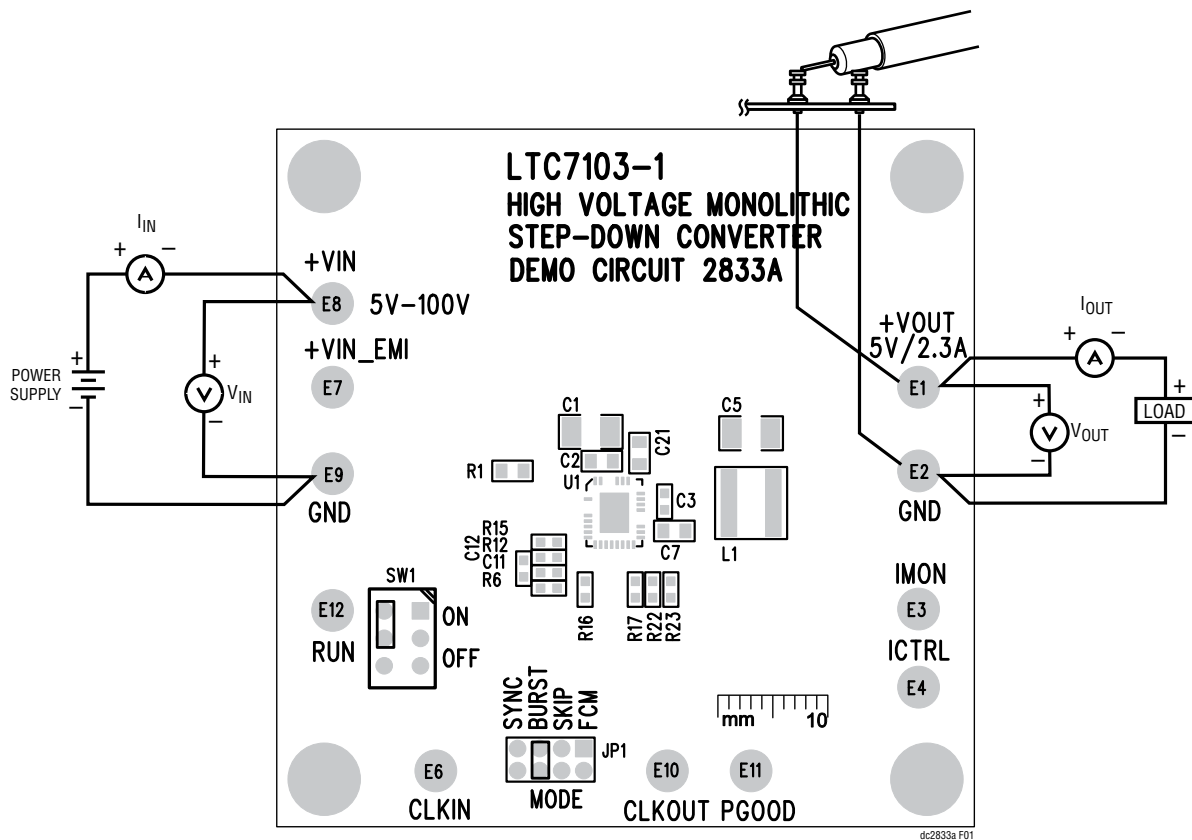

Figure 1. Proper Measurement Equipment Setup

QUICK START PROCEDURE

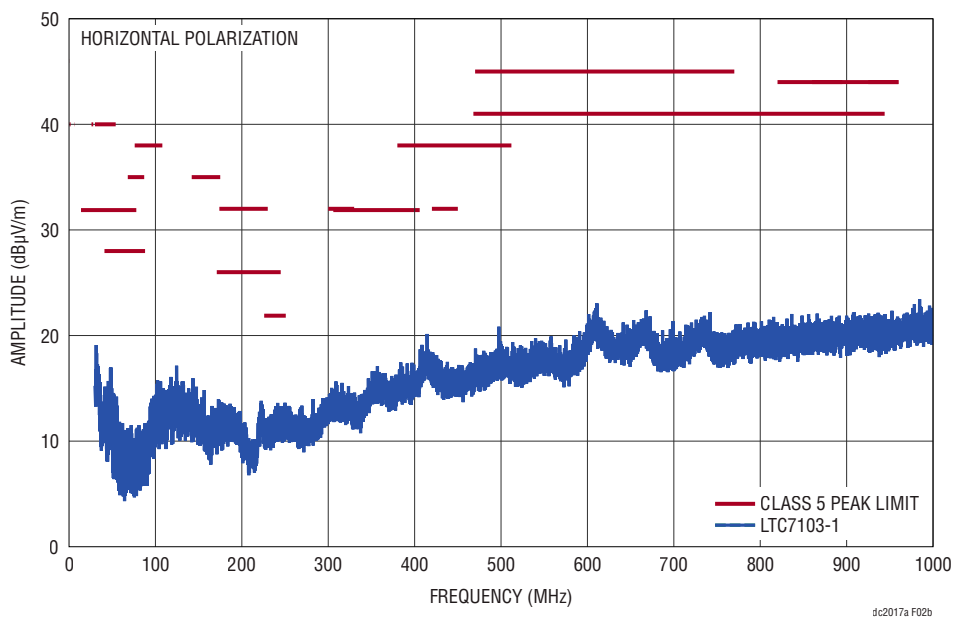
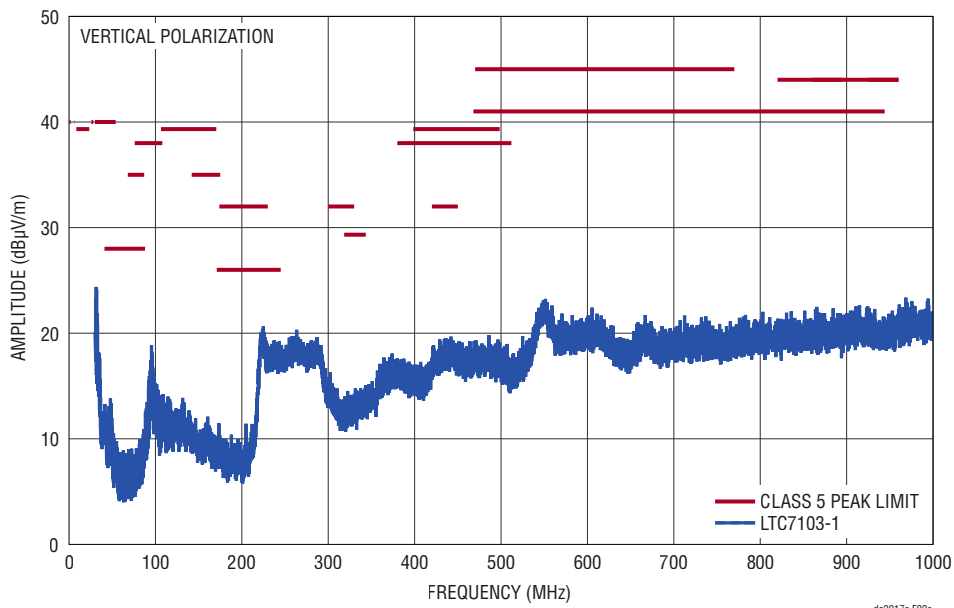

Figure 2. EMI Performance in CISPR 25 Radiated Emission Test (48V_{IN} from +VIN_EMI Turret Pin, 5V_{OUT}/2A, f_{SW} = 400kHz)

QUICK START PROCEDURE

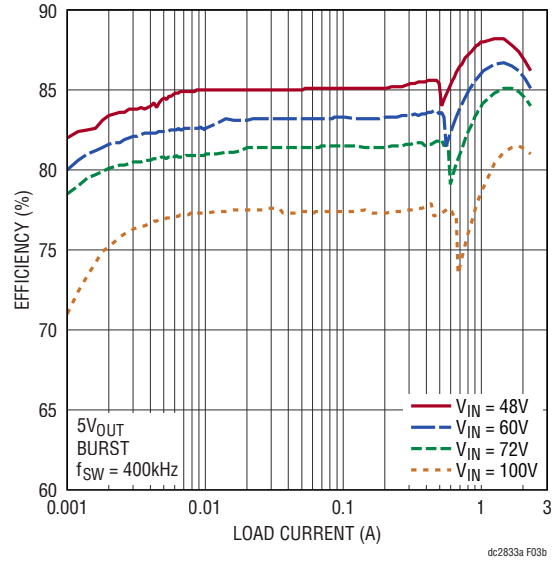
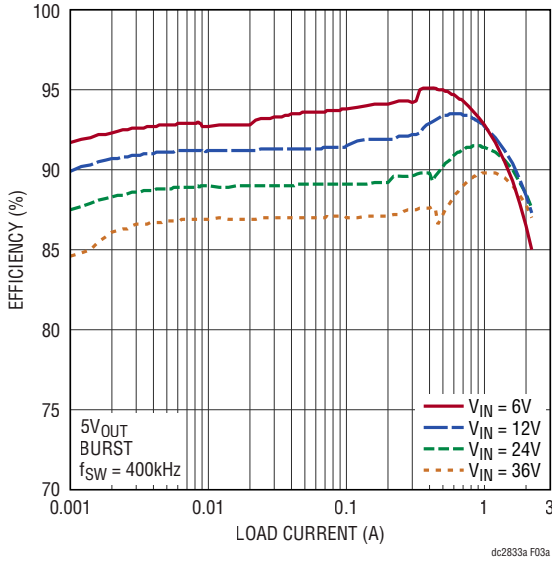

Figure 3. Efficiency at Various Input Voltages (Conditions: Burst Mode Operation)

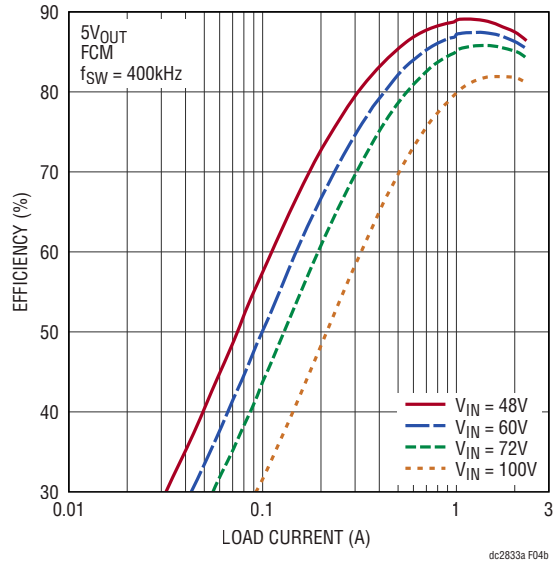
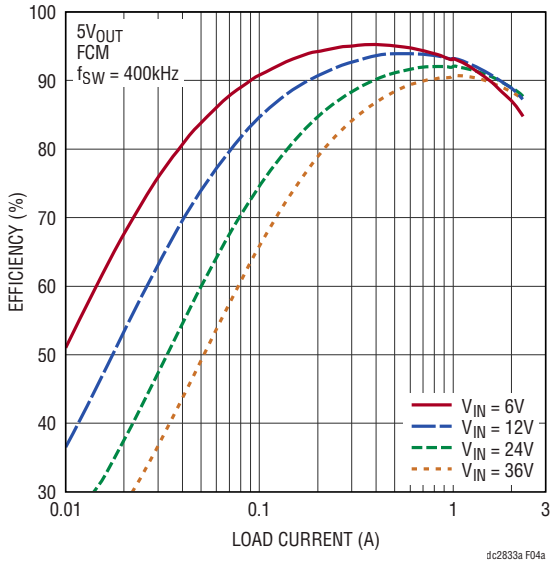

Figure 4. Efficiency at Various Input Voltages (Conditions: Forced Continuous Mode)

QUICK START PROCEDURE

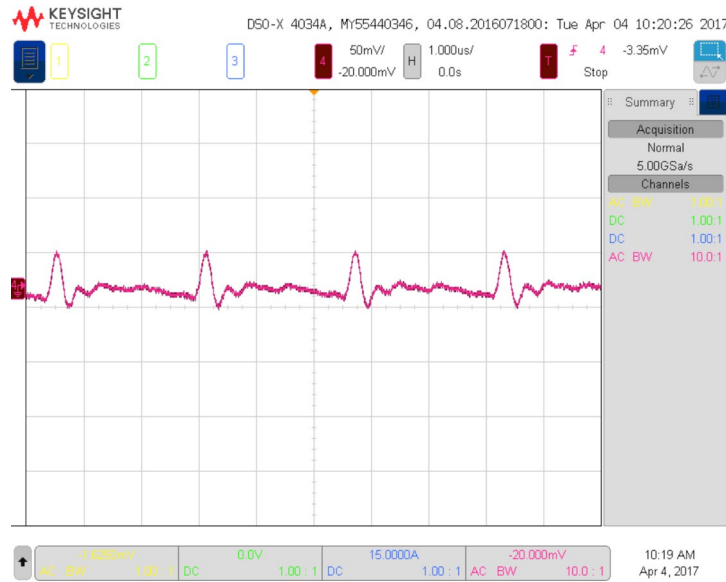

Figure 5. Output Ripple at 100V_{IN}, 5V_{OUT} and 2.3A_{OUT} (50mV, 500ns/DIV, 20MHz Bandwidth)

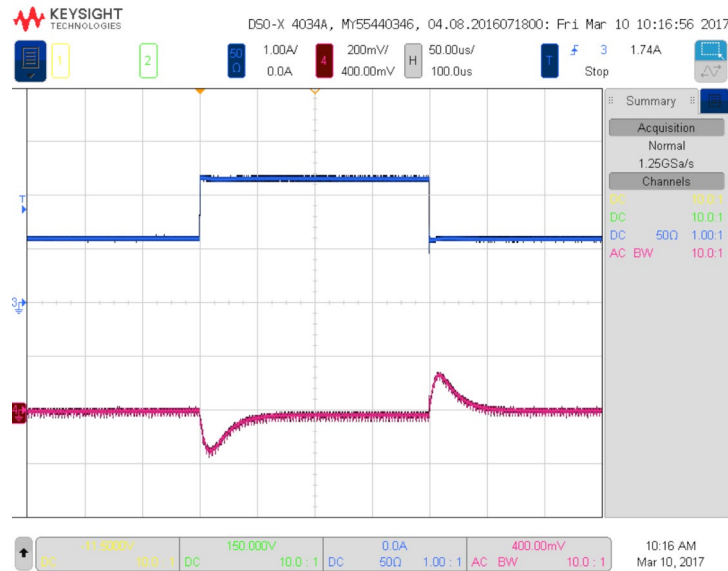

Figure 6. Transient Response Waveform at 48V_{IN}, 5V_{OUT} and 1.1A_{OUT} to 2.3A_{OUT} to 1.1A_{OUT} (1A, 200mV, 50μs/DIV, 20MHz Bandwidth)

QUICK START PROCEDURE

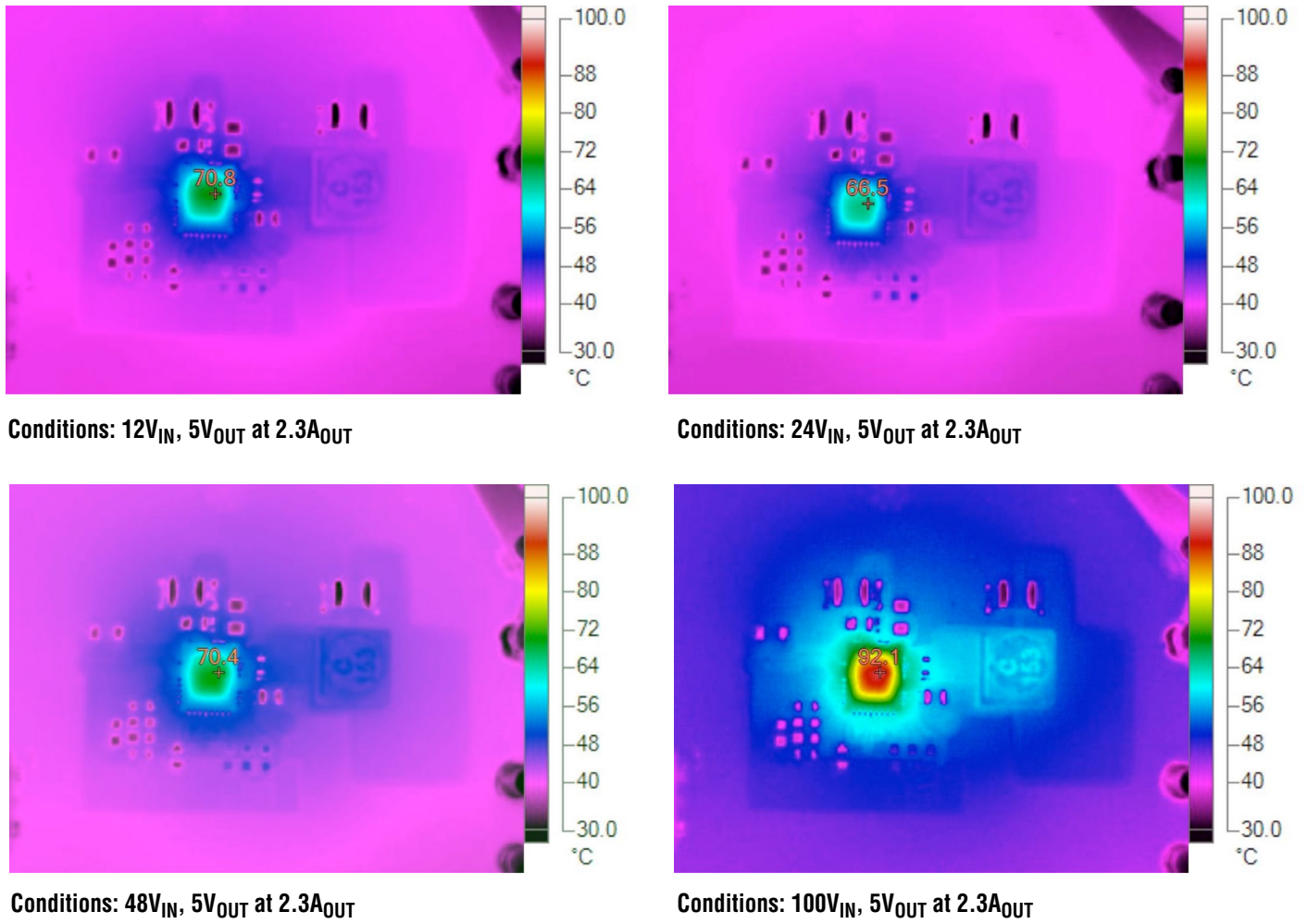

Figure 7. Thermal Plots ($T_A = 25^\circ\text{C}$, without Forced Air)

QUICK START PROCEDURE

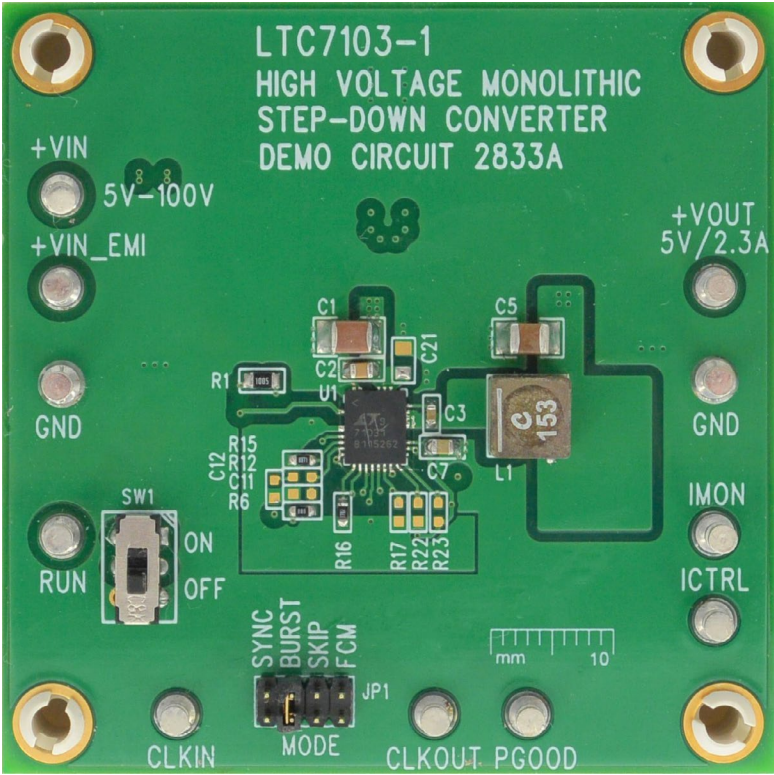

Figure 8. Board Photo

DEMO MANUAL DC2833A

PARTS LIST

ITEM	QTY	REFERENCE	PART DESCRIPTION	MANUFACTURER/PART NUMBER
Required Circuit Components				
1	3	C1, C13, C16	CAP, X7R 4.7 μ F, 100V, 10% 1210	MURATA, GRM32ER72A475KE14
2	1	C2	CAP, X7R, 0.1 μ F, 100V, 10%, 0805	MURATA, GCM21BR72A104KA37L
3	1	C3	CAP, X7R, 0.1 μ F, 25V, 10%, 0603	MURATA, GRM188R71E104KA01D
4	1	C5	CAP, X6S, 100 μ F, 6.3V, 20%, 1210	MURATA, GRM32EC80J107ME20L
5	1	C7	CAP, X7R, 1 μ F, 16V, 10%, 0805	AVX, 0805YC105KAT2A
6	1	C14	CAP, 33 μ F, 100V, 200mA	PANASONIC, EEEFK2A330P
7	1	C18	CAP, X7R, 1 μ F, 50V, 10%, 0603	YAGEO.,CC0603KRX7R9BB105
8	1	C20	CAP, X7R, 0.22 μ F, 100V, 10%, 0805	TAIYO YUDEN,HMK212B7224KGHT
9	1	L1	IND, 15 μ H	COILCRAFT, XEL6060-153ME
9	0	L1 (ALTERNATE)	IND, 15 μ H	WURTH, 74439346150
10	1	R1	RES, 10MEG, 1%, 0805	VISHAY, CRCW080510M0FKEA
11	5	R2, R5, R6, R14, R24	RES, 0 Ω , JUMPER 0603	VISHAY, CRCW06030000Z0EA
12	1	R8	RES, 1k, 1%, 0603	VISHAY, CRCW06031K00FKEA
13	1	R13	RES, 100k, 1%, 0603	VISHAY, CRCW0603100KFKEA
14	1	R15	RES, 8.87k, 1%, 0603	VISHAY, CRCW06038K87FKEA
15	1	R16	RES, 17.8k, 1%, 0603	NIC, NRC06F1782TRF
16	1	U1	LTC7103-1EUHE, QFN 5mm x 6mm	ANALOG DEVICES LTC7103-1EUHE#PBF
Additional Demo Board Circuit Components				
18	0	C4, C6, C8-C12, C15, C17, C19, C21	CAP, OPTIONAL	OPTIONAL
19	0	L2	IND, OPTIONAL	OPTIONAL
20	0	R3, R4, R7, R12, R17, R21-R23, R25-R27	RES, OPTIONAL	OPTIONAL
Hardware for Demo Board Only				
22	11	E1-E4, E6-E12	TESTPOINT, TURRET 0.095"	MILLMAX, 2501-2-00-80-00-00-07-0
23	2	FB1, FB2	FERRITE BEAD, 120 Ω AT 100MHz, 1206	MURATA., BLM31PG121SN1
24	1	FB3	RES, 0 Ω , SHUNT,1206	VISHAY, CRCW12060000Z0EA
25	1	JP1	HEADER, 4-PIN DBL ROW 2mm	SULLINS CONNECTOR, NRPN042PAEN-RC
26	1	XJP1	SHUNT	SAMTEC, 2SN-BK-G
27	1	SW1	SWITCHE, SUB MINIATURE SLIDE SWITCHE	C&K.,JS202011CQN
28	4	(STAND-OFFS)	STAND-OFF, NYLON 0.5" TALL	KEYSTONE, 8833 (SNAP ON)
29	1		FAB, PRINTED CIRCUIT BOARD	DEMO CIRCUIT 2833A
30	2		STENCILS TOP AND BOTTOM	STENCIL DC2833A

SCHEMATIC DIAGRAM

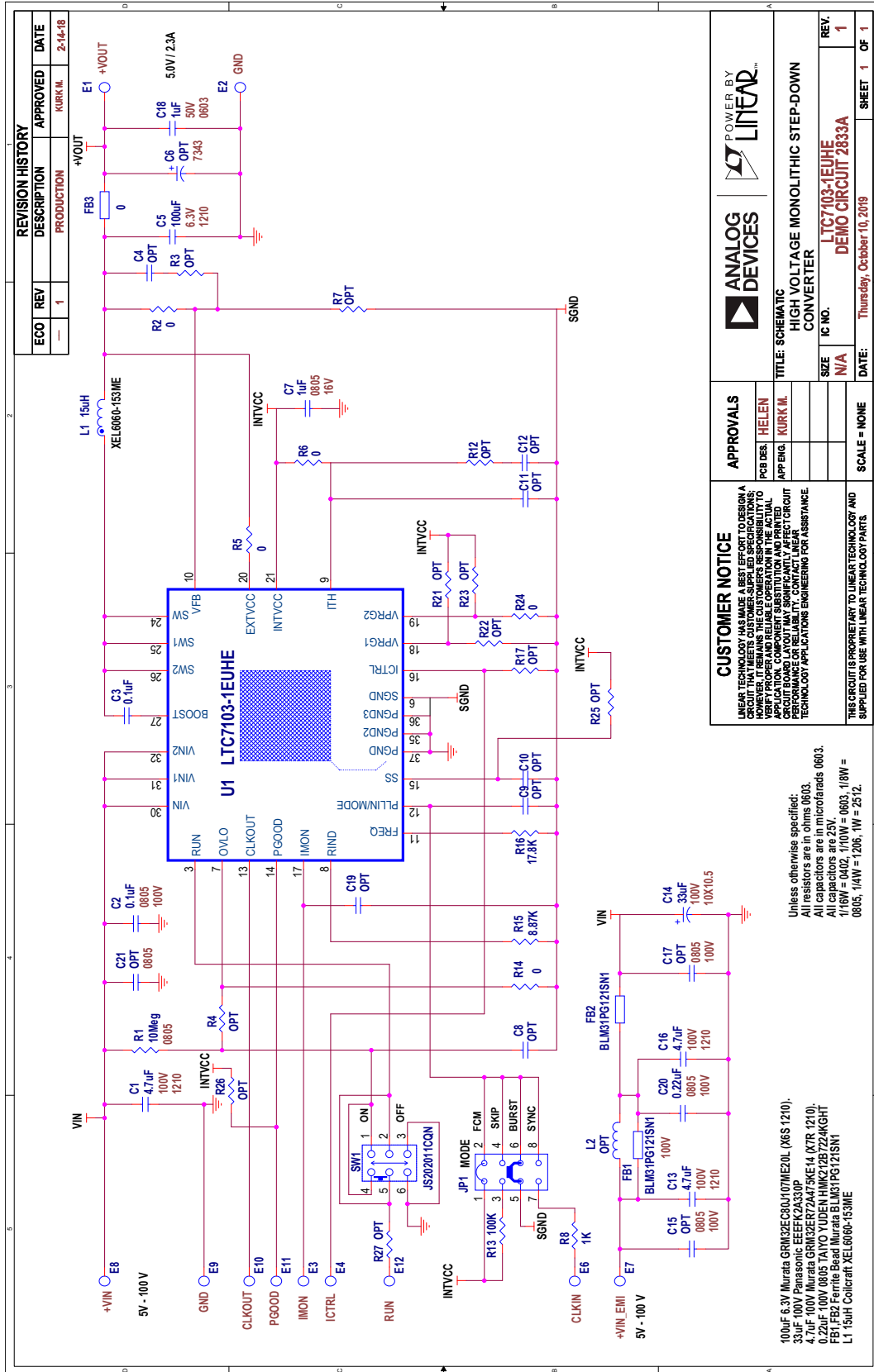

REVISION HISTORY			
ECO	REV	DESCRIPTION	APPROVED
—	1	PRODUCTION	KURK.M.
			DATE
			2-14-18

CUSTOMER NOTICE LINEAR TECHNOLOGY HAS MADE A BEST EFFORT TO DESIGN A CIRCUIT THAT MEETS CUSTOMER-SUPPLIED SPECIFICATIONS. CUSTOMER-SUPPLIED SPECIFICATIONS ARE THE BASIS FOR DESIGN AND TESTING. LINEAR TECHNOLOGY DOES NOT WARRANT THE PERFORMANCE OF ANY COMPONENT SUBSTITUTION AND PRINTED CIRCUIT BOARD FABRICATION. CUSTOMER MUST VERIFY PROPER AND RELIABLE OPERATION IN THE ACTUAL APPLICATION. CONTACT LINEAR TECHNOLOGY FOR RELIABILITY, CONTACT LINEAR TECHNOLOGY APPLICATIONS ENGINEERING FOR ASSISTANCE.	APPROVALS PCB DES. HELEN APP. ENG. KURK.M.	ANALOG DEVICES 	TITLE: SCHEMATIC HIGH VOLTAGE MONOLITHIC STEP-DOWN CONVERTER
	SCALE = NONE	SIZE N/A IC NO. LTC7103-1EUHE DEMO CIRCUIT 2833A	DATE: Thursday, October 10, 2019

Unless otherwise specified:
 All resistors are in ohms (Ω).
 All capacitors are in microfarads (µF).
 All capacitors are 25V.
 1/16W = 0402, 1/10W = 0803, 1/8W = 0805, 1/4W = 1206, 1W = 2512.

100µF 6.3V Murata GRM32EC60107ME20L (X6S 1210).
 33µF 100V Panasonic EEEFK2A33JP.
 4.7µF 100V Murata GRM32ER72A475KE14 (X7R 1210).
 0.22µF 100V TAIYO YUDEN HMK21281224KGHT.
 FB1, FB2 Ferrite Bead Murata BLM31PG121SN1.
 L1 150µH Coilcraft XEL6060-153ME.





ESD Caution

ESD (electrostatic discharge) sensitive device. Charged devices and circuit boards can discharge without detection. Although this product features patented or proprietary protection circuitry, damage may occur on devices subjected to high energy ESD. Therefore, proper ESD precautions should be taken to avoid performance degradation or loss of functionality.

Legal Terms and Conditions

By using the evaluation board discussed herein (together with any tools, components documentation or support materials, the "Evaluation Board"), you are agreeing to be bound by the terms and conditions set forth below ("Agreement") unless you have purchased the Evaluation Board, in which case the Analog Devices Standard Terms and Conditions of Sale shall govern. Do not use the Evaluation Board until you have read and agreed to the Agreement. Your use of the Evaluation Board shall signify your acceptance of the Agreement. This Agreement is made by and between you ("Customer") and Analog Devices, Inc. ("ADI"), with its principal place of business at One Technology Way, Norwood, MA 02062, USA. Subject to the terms and conditions of the Agreement, ADI hereby grants to Customer a free, limited, personal, temporary, non-exclusive, non-sublicensable, non-transferable license to use the Evaluation Board FOR EVALUATION PURPOSES ONLY. Customer understands and agrees that the Evaluation Board is provided for the sole and exclusive purpose referenced above, and agrees not to use the Evaluation Board for any other purpose. Furthermore, the license granted is expressly made subject to the following additional limitations: Customer shall not (i) rent, lease, display, sell, transfer, assign, sublicense, or distribute the Evaluation Board; and (ii) permit any Third Party to access the Evaluation Board. As used herein, the term "Third Party" includes any entity other than ADI, Customer, their employees, affiliates and in-house consultants. The Evaluation Board is NOT sold to Customer; all rights not expressly granted herein, including ownership of the Evaluation Board, are reserved by ADI. CONFIDENTIALITY. This Agreement and the Evaluation Board shall all be considered the confidential and proprietary information of ADI. Customer may not disclose or transfer any portion of the Evaluation Board to any other party for any reason. Upon discontinuation of use of the Evaluation Board or termination of this Agreement, Customer agrees to promptly return the Evaluation Board to ADI. ADDITIONAL RESTRICTIONS. Customer may not disassemble, decompile or reverse engineer chips on the Evaluation Board. Customer shall inform ADI of any occurred damages or any modifications or alterations it makes to the Evaluation Board, including but not limited to soldering or any other activity that affects the material content of the Evaluation Board. Modifications to the Evaluation Board must comply with applicable law, including but not limited to the RoHS Directive. TERMINATION. ADI may terminate this Agreement at any time upon giving written notice to Customer. Customer agrees to return to ADI the Evaluation Board at that time. LIMITATION OF LIABILITY. THE EVALUATION BOARD PROVIDED HEREUNDER IS PROVIDED "AS IS" AND ADI MAKES NO WARRANTIES OR REPRESENTATIONS OF ANY KIND WITH RESPECT TO IT. ADI SPECIFICALLY DISCLAIMS ANY REPRESENTATIONS, ENDORSEMENTS, GUARANTEES, OR WARRANTIES, EXPRESS OR IMPLIED, RELATED TO THE EVALUATION BOARD INCLUDING, BUT NOT LIMITED TO, THE IMPLIED WARRANTY OF MERCHANTABILITY, TITLE, FITNESS FOR A PARTICULAR PURPOSE OR NON-INFRINGEMENT OF INTELLECTUAL PROPERTY RIGHTS. IN NO EVENT WILL ADI AND ITS LICENSORS BE LIABLE FOR ANY INCIDENTAL, SPECIAL, INDIRECT, OR CONSEQUENTIAL DAMAGES RESULTING FROM CUSTOMER'S POSSESSION OR USE OF THE EVALUATION BOARD, INCLUDING BUT NOT LIMITED TO LOST PROFITS, DELAY COSTS, LABOR COSTS OR LOSS OF GOODWILL. ADI'S TOTAL LIABILITY FROM ANY AND ALL CAUSES SHALL BE LIMITED TO THE AMOUNT OF ONE HUNDRED US DOLLARS (\$100.00). EXPORT. Customer agrees that it will not directly or indirectly export the Evaluation Board to another country, and that it will comply with all applicable United States federal laws and regulations relating to exports. GOVERNING LAW. This Agreement shall be governed by and construed in accordance with the substantive laws of the Commonwealth of Massachusetts (excluding conflict of law rules). Any legal action regarding this Agreement will be heard in the state or federal courts having jurisdiction in Suffolk County, Massachusetts, and Customer hereby submits to the personal jurisdiction and venue of such courts. The United Nations Convention on Contracts for the International Sale of Goods shall not apply to this Agreement and is expressly disclaimed.