

0.5 Nm ovoid 3.9 Watts 3.9 W Part number made to order



- Torque rating of gearboxes : 0.5 Nm, high-performance plastic gears
- Motors : nominal power 3 W, interference suppression for standard stocked products
- Wide speed range : 0.3 to 430 rpm
- Optional encoder built into the motor

Part numbers

	Type	Type	Voltage	Standard speed (rpm)	Output speed (rpm)	Ratios (i)
82861023	3.9 W	828610	24 V	4300	3,6	1200

Specifications

General characteristics

Motor	828600
Gearbox	810210
Maximum permitted torque from gearmotor under continuous conditions for 1 million turns (Nm)	0.5
Axial load static (daN)	1
Radial load static (daN)	8
Max. output power (W)	3,9
Nominal output (W)	3
Gearbox case temperature rise (°C)	50
Weight (g)	160

Made to order products, available on request

Motors :

- Other supply voltages
- Motor with 2 ball bearings
- Shaft lengths at front and/or rear
- Lead outputs or radial tag terminals
- Special interference suppression
- Encoder : 5 pulses/rev

Gearboxes :

- Special shaft
- Ball bearing
- Special greasing
- Torque limiter F
- Gearbox fixing M3
- Other speeds

Dimensions (mm)

828610



N°	Legend

①	2 fixing holes \varnothing 3.2
②	2 standard tags NFC 20-120, series 2.8 x 0.5 mm
③	Shaft pushed-in
④	3.5 across flats

Dimensions (mm)

Shaft 70999421
SP1295.10



N°	Legend
①	Shaft pushed-in
②	5 across flats

Dimensions (mm)

Shaft 79200779



N°	Legend
①	Shaft pushed-in

Dimensions (mm)

Shaft 79200967

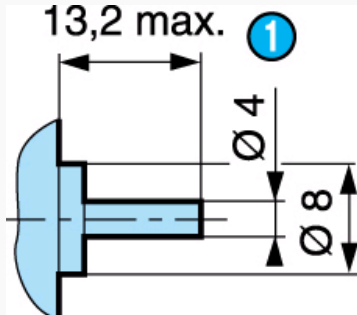

N°	Legend
----	--------

**Curves**

Curve : torque/nominal speed 828610



N°

Legend

①

rpm

Product adaptations

- Special supply voltage
- Lead output
- 1 or 5 pulse encoder
- Special connectors
- Special shaft
- Special reduction ratio
- Special materials for gears
- Special ball bearings
- Special adaptor plate
- EMC filter
- More than 200 reduction ratios available