

# XC40S-1503A0A00BA0

C4000 Select

SAFETY LIGHT CURTAINS

**SICK**  
Sensor Intelligence.

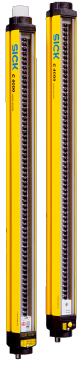

Illustration may differ



### Ordering information

Resolution	Scanning range	Protective field height	System part	Type	Part no.
30 mm	21 m	1,500 mm	Sender	XC40S-1503A0A00BA0	1204162

Other models and accessories → [www.sick.com/C4000\\_Select](http://www.sick.com/C4000_Select)

### Detailed technical data

#### Features

<b>Application</b>	Normal industrial environment
<b>System part</b>	Sender
<b>Resolution</b>	30 mm
<b>Scanning range</b>	21 m
<b>Protective field height</b>	1,500 mm
<b>Synchronization</b>	Optical synchronisation
<b>Integrated laser alignment aid</b>	✓

#### Safety-related parameters

<b>Type</b>	Type 4 (IEC 61496-1)
<b>Safety integrity level</b>	SIL3 (IEC 61508)
<b>Category</b>	Category 4 (EN ISO 13849)
<b>Performance level</b>	PL e (EN ISO 13849)
<b>PFH<sub>D</sub> (mean probability of a dangerous failure per hour)</b>	$3.2 \times 10^{-8}$ (EN ISO 13849)
<b>T<sub>M</sub> (mission time)</b>	20 years (EN ISO 13849)
<b>Safe state in the event of a fault</b>	At least one OSSD is in the OFF state.

#### Functions

	Functions	Delivery status
<b>Protective operation</b>	✓	
<b>Beam coding</b>	✓	Uncoded
<b>Configurable scanning range</b>	✓	
<b>Floating blanking</b>	✓	

#### Interfaces

<b>System connection</b>	Male connector M12, 5-pin
--------------------------	---------------------------

<sup>1)</sup> Depending on load, power supply and wire cross-section. The technical specifications must be observed.

Permitted cable length	≤ 30 m <sup>1)</sup>
<b>Extension connection</b>	Female connector M12, 5-pin
<b>Configuration method</b>	DIP switch
<b>Display elements</b>	7-segment display

<sup>1)</sup> Depending on load, power supply and wire cross-section. The technical specifications must be observed.

## Electrical data

<b>Protection class</b>	III (IEC 61140)
<b>Supply voltage <math>V_s</math></b>	24 V DC (19.2 V ... 28.8 V) <sup>1)</sup>
<b>Residual ripple</b>	≤ 10 % <sup>2)</sup>

<sup>1)</sup> The external voltage supply must be capable of buffering brief mains voltage failures of 20 ms as specified in EN 60204-1. Suitable power supplies are available as accessories from SICK.

<sup>2)</sup> Within the limits of  $V_s$ .

## Mechanical data

<b>Dimensions</b>	See dimensional drawing
<b>Housing material</b>	Aluminum extruded profile

## Ambient data

<b>Enclosure rating</b>	IP65 (EN 60529)
<b>Ambient operating temperature</b>	0 °C ... +55 °C
<b>Storage temperature</b>	-25 °C ... +70 °C
<b>Air humidity</b>	15 % ... 95 %, Non-condensing
<b>Vibration resistance</b>	5 g, 10 Hz ... 55 Hz (EN 60068-2-6)
<b>Shock resistance</b>	10 g, 16 ms (EN 60068-2-27)

## Other information

<b>Wave length</b>	950 nm
<b>Integrated laser alignment aid</b>	✓
Light source	LED
Laser class	1 (IEC 60825-1), eye-safe
Type of light	Visible red light

## Classifications

<b>eCl@ss 5.0</b>	27272704
<b>eCl@ss 5.1.4</b>	27272704
<b>eCl@ss 6.0</b>	27272704
<b>eCl@ss 6.2</b>	27272704
<b>eCl@ss 7.0</b>	27272704
<b>eCl@ss 8.0</b>	27272704
<b>eCl@ss 8.1</b>	27272704
<b>eCl@ss 9.0</b>	27272704
<b>eCl@ss 10.0</b>	27272704
<b>eCl@ss 11.0</b>	27272704
<b>eCl@ss 12.0</b>	27272704

<b>ETIM 5.0</b>	EC002549
<b>ETIM 6.0</b>	EC002549
<b>ETIM 7.0</b>	EC002549
<b>ETIM 8.0</b>	EC002549
<b>UNSPSC 16.0901</b>	46171620

### Dimensional drawing (Dimensions in mm (inch))

Sender

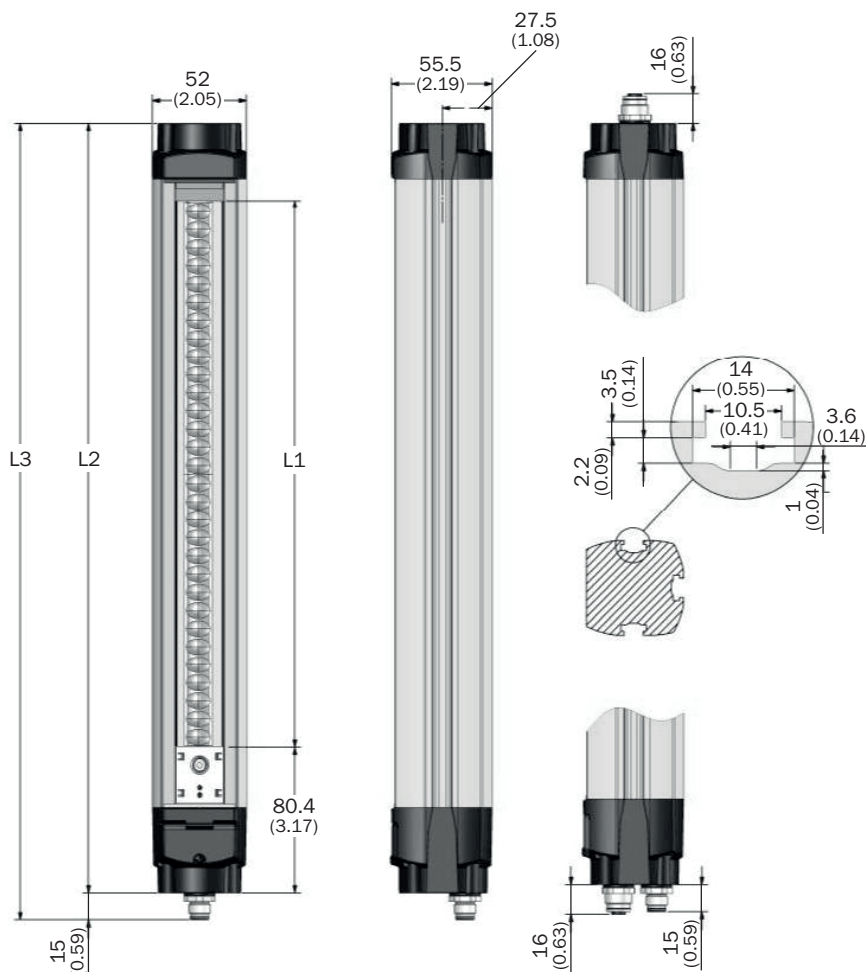







Protective field height S	L1	L2	L3
300 (11.81)	302 (11.89)	425 (16.73)	440 (17.32)
450 (17.72)	452 (17.80)	575 (22.64)	590 (23.23)
600 (23.62)	602 (23.70)	725 (28.54)	740 (29.13)
750 (29.53)	752 (29.61)	875 (34.45)	890 (35.04)
900 (35.43)	902 (35.51)	1,025 (40.35)	1,040 (40.94)
1,050 (41.34)	1,052 (41.42)	1,175 (46.26)	1,190 (46.85)
1,200 (47.24)	1,202 (47.32)	1,325 (52.17)	1,340 (52.76)
1,350 (53.15)	1,352 (53.23)	1,475 (58.07)	1,490 (58.66)

Protective field height S	L1	L2	L3
1,500 (59.06)	1,502 (59.13)	1,625 (63.98)	1,640 (64.57)
1,650 (64.96)	1,652 (65.04)	1,775 (69.88)	1,790 (70.47)
1,800 (70.87)	1,802 (70.94)	1,925 (75.79)	1,940 (76.38)

### Recommended accessories

Other models and accessories → [www.sick.com/C4000\\_Select](http://www.sick.com/C4000_Select)

	Brief description	Type	Part no.
<b>Alignment aids</b>			
	Laser alignment aid for various sensors, laser class 2 (IEC 60825). Do not look into the beam!, 19 mm x 67.3 mm x 66.9 mm	AR60	1015741
<b>Optics cloths</b>			
	Cloth for cleaning optical surfaces	Lens cloth	4003353
<b>Mounting brackets and plates</b>			
	4 pieces, Mounting kit 1, mounting bracket, rigid, L-shaped, including fixing screws and washers	BEF-3WNGBAST4	7021352
<b>Plug connectors and cables</b>			
	Head A: female connector, M12, 5-pin, straight, A-coded Head B: male connector, M12, 5-pin, straight, A-coded Cable: Sensor/actuator cable, PUR, halogen-free, unshielded, 2 m	YF2A15-020UB5M2A15	2096009
<b>Terminal and alignment brackets</b>			
	4 pieces, Mounting kit 6, side bracket, rotatable, zinc diecast	BEF-1SHABAZN4	2019506
	4 pieces, Mounting kit 12, rotatable, swivel mount	BEF-2SMGEAKU4	2030510

## SICK AT A GLANCE

SICK is one of the leading manufacturers of intelligent sensors and sensor solutions for industrial applications. A unique range of products and services creates the perfect basis for controlling processes securely and efficiently, protecting individuals from accidents and preventing damage to the environment.

We have extensive experience in a wide range of industries and understand their processes and requirements. With intelligent sensors, we can deliver exactly what our customers need. In application centers in Europe, Asia and North America, system solutions are tested and optimized in accordance with customer specifications. All this makes us a reliable supplier and development partner.

Comprehensive services complete our offering: SICK LifeTime Services provide support throughout the machine life cycle and ensure safety and productivity.

For us, that is “Sensor Intelligence.”

## WORLDWIDE PRESENCE:

Contacts and other locations –[www.sick.com](http://www.sick.com)