



WL27-3S3731S03

W27-3

COMPACT PHOTOELECTRIC SENSORS

**SICK**  
Sensor Intelligence.



Illustration may differ



## Ordering information

Type	Part no.
WL27-3S3731S03	1029145

Other models and accessories → [www.sick.com/W27-3](http://www.sick.com/W27-3)

## Detailed technical data

### Features

<b>Functional principle</b>	Photoelectric retro-reflective sensor
<b>Functional principle detail</b>	Dual lens
<b>Dimensions (W x H x D)</b>	24.6 mm x 80.6 mm x 54 mm
<b>Housing design (light emission)</b>	Rectangular
<b>Sensing range max.</b>	0.1 m ... 15 m <sup>1)</sup>
<b>Sensing range</b>	0.1 m ... 11 m <sup>1)</sup>
<b>Focus</b>	Approx. 1.5°
<b>Type of light</b>	Visible red light
<b>Light source</b>	LED <sup>2)</sup>
<b>Light spot size (distance)</b>	Ø 220 mm (10 m)
<b>Angle of dispersion</b>	Approx. 1.5°
<b>Wave length</b>	660 nm
<b>Adjustment</b>	Potentiometer

<sup>1)</sup> Reflector PL80A.

<sup>2)</sup> Average service life: 100,000 h at T<sub>U</sub> = +25 °C.

### Mechanics/electronics

<b>Supply voltage</b>	20 V AC/DC ... 250 V AC/DC <sup>1)</sup>
<b>Power consumption</b>	≤ 2.5 VA

<sup>1)</sup> Limit values.

<sup>2)</sup> Provide suitable spark suppression for inductive or capacitive loads.

<sup>3)</sup> With light/dark ratio 1:1.

<sup>4)</sup> A = V<sub>S</sub> connections reverse-polarity protected.

<sup>5)</sup> C = interference suppression.

<sup>6)</sup> Reference voltage: 250 V AC, overvoltage category 2.

<b>Switching output</b>	Relay, electrically isolated <sup>2)</sup>
<b>Output function</b>	Change-over contacts
<b>Switching mode</b>	Dark switching
<b>Switching current (switching voltage)</b>	4 A @ 250 V AC, 4 A @ 24 V DC, 0.125 A @ 250 V DC UL: 4 A @ 250 V AC, general use / 4 A @ 250 V AC, resistive (NO) / 3 A @ 250 V AC, resistive (NC) / 4 A @ 24 V DC, NO, general use / 3 A @ 24 V DC, NC, general use / R300 / B300 (NO contacts only) / 0 °C ... +60 °C
<b>Response time</b>	≤ 10 ms
<b>Switching frequency</b>	10 Hz <sup>3)</sup>
<b>Connection type</b>	Cable with connector Q7, 7-pin, AC/UC-coding, 150 mm
<b>Cable material</b>	PVC
<b>Circuit protection</b>	A <sup>4)</sup> C <sup>5)</sup>
<b>Protection class</b>	II <sup>6)</sup>
<b>Weight</b>	140 g
<b>Polarisation filter</b>	✓
<b>Special device</b>	✓
<b>Housing material</b>	Plastic, ABS
<b>Optics material</b>	Plastic, PMMA
<b>Enclosure rating</b>	IP66 IP67
<b>Ambient operating temperature</b>	-40 °C ... +60 °C
<b>Ambient temperature, storage</b>	-40 °C ... +75 °C
<b>UL File No.</b>	NRKH.E181493 & NRKH7.E181493

<sup>1)</sup> Limit values.

<sup>2)</sup> Provide suitable spark suppression for inductive or capacitive loads.

<sup>3)</sup> With light/dark ratio 1:1.

<sup>4)</sup> A = V<sub>S</sub> connections reverse-polarity protected.

<sup>5)</sup> C = interference suppression.

<sup>6)</sup> Reference voltage: 250 V AC, overvoltage category 2.

## Safety-related parameters

<b>MTTF<sub>D</sub></b>	1,147 years
<b>DC<sub>avg</sub></b>	0 %

## Classifications

<b>eCl@ss 5.0</b>	27270902
<b>eCl@ss 5.1.4</b>	27270902
<b>eCl@ss 6.0</b>	27270902
<b>eCl@ss 6.2</b>	27270902
<b>eCl@ss 7.0</b>	27270902
<b>eCl@ss 8.0</b>	27270902
<b>eCl@ss 8.1</b>	27270902
<b>eCl@ss 9.0</b>	27270902
<b>eCl@ss 10.0</b>	27270902

<b>eCl@ss 11.0</b>	27270902
<b>eCl@ss 12.0</b>	27270902
<b>ETIM 5.0</b>	EC002717
<b>ETIM 6.0</b>	EC002717
<b>ETIM 7.0</b>	EC002717
<b>ETIM 8.0</b>	EC002717
<b>UNSPSC 16.0901</b>	39121528

Connection type

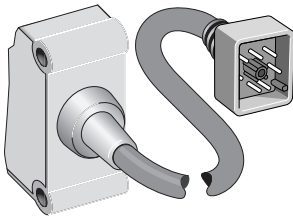

Connection diagram

Cd-193

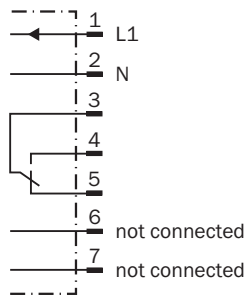

### Characteristic curve

WL27-3

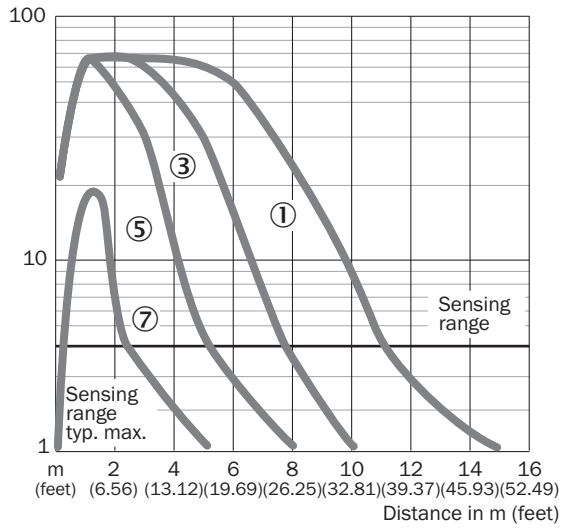

- ① Reflector PL80A
- ② Reflector PL50A
- ③ Reflector PL40A
- ⑤ Reflector PL20A
- ⑦ Reflective tape Diamond Grade

### Sensing range diagram

WL27-3

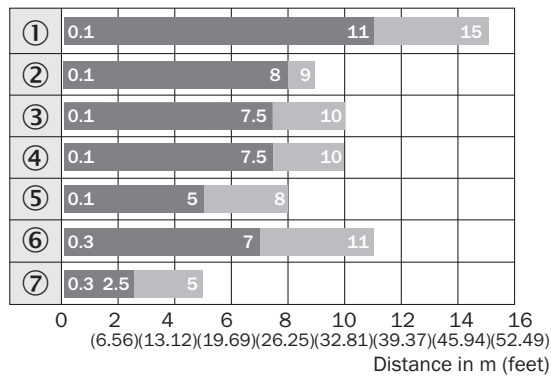

- Sensing range
- Sensing range max.
- ① Reflector PL80A
- ② Reflector PL50A
- ③ Reflector PL40A
- ④ Reflector PL30A
- ⑤ Reflector PL20A
- ⑥ Reflector C110A
- ⑦ Reflective tape Diamond Grade

## Adjustments

Potentiometer

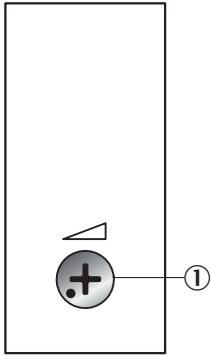

① Potentiometer

## Dimensional drawing (Dimensions in mm (inch))

WL27-3, potentiometer

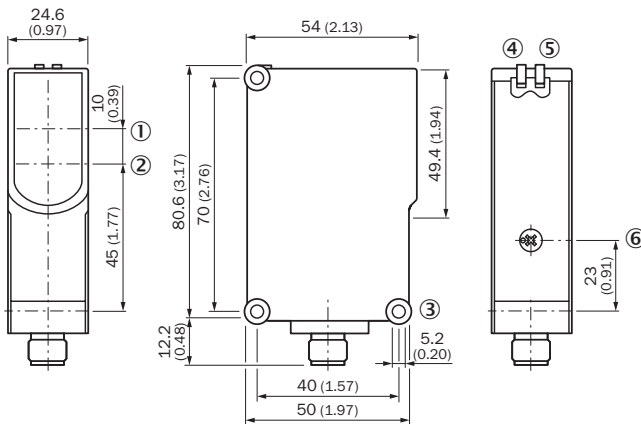



- ① Optical axis, sender
- ② Optical axis, receiver
- ③ Mounting hole  $\varnothing$  5.2 mm
- ④ LED indicator green: Supply voltage active
- ⑤ LED indicator yellow: Status of received light beam
- ⑥ Sensitivity control ( 10 revolutions)

## Recommended accessories

Other models and accessories → [www.sick.com/W27-3](http://www.sick.com/W27-3)

	Brief description	Type	Part no.
Device protection (mechanical)			
	Protective housing for W26, W27-3 and mounting rods with diameter 12 mm ... 20 mm, Zinc plated steel (protective housing), Zinc die cast (clamping bracket), Universal clamp BEF-KHS-KH1 (2022726), mounting hardware	BEF-SG-W27	2039601

	<b>Brief description</b>	<b>Type</b>	<b>Part no.</b>
<b>Mounting brackets and plates</b>			
	Universal mounting bracket for reflectors, steel, zinc coated	BEF-WN-REFX	2064574
<b>Plug connectors and cables</b>			
	Head A: female connector, Q7, 7-pin, angled, AC-coded Cable: unshielded	DOS-2207-W	6006821
<b>Reflectors</b>			
	Rectangular, screw connection, 84 mm x 84 mm, PMMA/ABS, Screw-on, 2 hole mounting	PL80A	1003865

## SICK AT A GLANCE

SICK is one of the leading manufacturers of intelligent sensors and sensor solutions for industrial applications. A unique range of products and services creates the perfect basis for controlling processes securely and efficiently, protecting individuals from accidents and preventing damage to the environment.

We have extensive experience in a wide range of industries and understand their processes and requirements. With intelligent sensors, we can deliver exactly what our customers need. In application centers in Europe, Asia and North America, system solutions are tested and optimized in accordance with customer specifications. All this makes us a reliable supplier and development partner.

Comprehensive services complete our offering: SICK LifeTime Services provide support throughout the machine life cycle and ensure safety and productivity.

For us, that is “Sensor Intelligence.”

## WORLDWIDE PRESENCE:

Contacts and other locations –[www.sick.com](http://www.sick.com)