



WL27-3P3402S17

RAY26 Reflex Array

MULTITASK PHOTOELECTRIC SENSORS

SICK
Sensor Intelligence.



Illustration may differ



Ordering information

Type	Part no.
WL27-3P3402S17	1051529

Other models and accessories → www.sick.com/RAY26_Reflex_Array

Detailed technical data

Features

Functional principle	Photoelectric retro-reflective sensor
Dimensions (W x H x D)	24.6 mm x 80 mm x 54.2 mm
Housing design (light emission)	Rectangular
Minimum object size	5 mm, position-independent detection within the light array
Sensing range max.	0 m ... 1.5 m ¹⁾
Sensing range	0 m ... 1.5 m ¹⁾
Distance of the sensor to reflector	0.5 m ... 1.5 m ¹⁾
Type of light	Visible red light
Light source	PinPoint LED ²⁾
Adjustment	Single teach-in button
AutoAdapt	✓
Special feature	Light band
Special applications	Detecting transparent objects, Detecting perforated objects, Detecting uneven, shiny objects, Detecting objects with position tolerances
Special features	Detection height 24 mm

¹⁾ Reflector PL40A.

²⁾ Average service life: 100,000 h at T_J = +25 °C.

Mechanics/electronics

Supply voltage	10 V DC ... 30 V DC ¹⁾
Ripple	< 5 V _{pp} ²⁾
Current consumption	35 mA ³⁾
Switching output	PNP
Output function	Complementary
Switching mode	Light/dark switching
Signal voltage PNP HIGH/LOW	Approx. V _S - 2.5 V / 0 V
Output current I_{max.}	≤ 100 mA
Response time	≤ 2.5 ms ⁴⁾
Switching frequency	200 Hz ⁵⁾
Connection type	Cable with M12 male connector, 4-pin, 270 mm ⁶⁾
Cable material	PVC
Circuit protection	A ⁷⁾ B ⁸⁾ C ⁹⁾
Protection class	II ¹⁰⁾
Weight	130 g
Housing material	Plastic, ABS
Optics material	Plastic, PMMA
Enclosure rating	IP67
Special feature	Light band
Ambient operating temperature	-30 °C ... +60 °C ¹¹⁾
Ambient temperature, storage	-40 °C ... +75 °C
UL File No.	NRKH.E181493 & NRKH7.E181493

¹⁾ Limit values when operated in short-circuit protected network: max. 8 A.

²⁾ May not exceed or fall below U_v tolerances.

³⁾ Without load.

⁴⁾ Signal transit time with resistive load.

⁵⁾ With light/dark ratio 1:1.

⁶⁾ Do not bend below 0 °C.

⁷⁾ A = V_S connections reverse-polarity protected.

⁸⁾ B = inputs and output reverse-polarity protected.

⁹⁾ C = interference suppression.

¹⁰⁾ Reference voltage: 50 V DC.

¹¹⁾ Avoid condensation on the front screen of the sensor and on the reflector.

Safety-related parameters

MTTF_D	976 years
DC_{avg}	0 %

Classifications

eCl@ss 5.0	27270902
eCl@ss 5.1.4	27270902
eCl@ss 6.0	27270902

eCl@ss 6.2	27270902
eCl@ss 7.0	27270902
eCl@ss 8.0	27270902
eCl@ss 8.1	27270902
eCl@ss 9.0	27270902
eCl@ss 10.0	27270902
eCl@ss 11.0	27270902
eCl@ss 12.0	27270902
ETIM 5.0	EC002717
ETIM 6.0	EC002717
ETIM 7.0	EC002717
ETIM 8.0	EC002717
UNSPSC 16.0901	39121528

Connection type

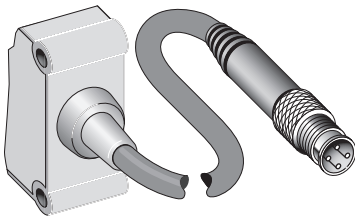

Connection diagram

Cd-083

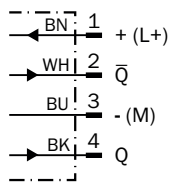

Adjustments

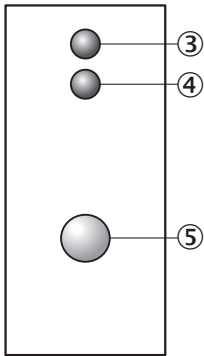

- ③ LED indicator green: Supply voltage active
- ④ LED indicator yellow: Status of received light beam
- ⑤ Sensitivity setting: single teach-in button

Dimensional drawing (Dimensions in mm (inch))

WL27-3P3402S17

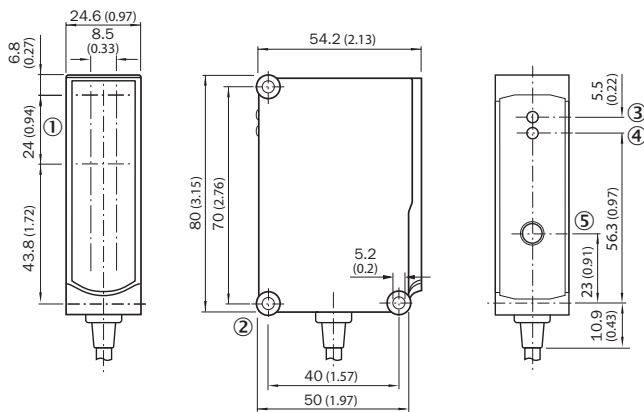

- ① Opening of light band
- ② Mounting hole \varnothing 5.2 mm
- ③ LED indicator green: Supply voltage active
- ④ LED indicator yellow: Status of received light beam
- ⑤ Sensitivity setting: single teach-in button



Recommended accessories

Other models and accessories → www.sick.com/RAY26_Reflex_Array

	Brief description	Type	Part no.
Mounting brackets and plates			
	Universal mounting bracket for reflectors, steel, zinc coated	BEF-WN-REFX	2064574

WL27-3P3402S17 | RAY26 Reflex Array

MULTITASK PHOTOELECTRIC SENSORS

	Brief description	Type	Part no.
Plug connectors and cables			
	Head A: female connector, M12, 4-pin, straight, A-coded Head B: Flying leads Cable: Sensor/actuator cable, PVC, unshielded, 5 m	YF2A14-050VB3XLEAX	2096235
	Head A: male connector, M12, 4-pin, straight Cable: unshielded	STE-1204-G	6009932
Reflectors			
	Rectangular, screw connection, 84 mm x 84 mm, PMMA/ABS, Screw-on, 2 hole mounting	PL80A	1003865

SICK AT A GLANCE

SICK is one of the leading manufacturers of intelligent sensors and sensor solutions for industrial applications. A unique range of products and services creates the perfect basis for controlling processes securely and efficiently, protecting individuals from accidents and preventing damage to the environment.

We have extensive experience in a wide range of industries and understand their processes and requirements. With intelligent sensors, we can deliver exactly what our customers need. In application centers in Europe, Asia and North America, system solutions are tested and optimized in accordance with customer specifications. All this makes us a reliable supplier and development partner.

Comprehensive services complete our offering: SICK LifeTime Services provide support throughout the machine life cycle and ensure safety and productivity.

For us, that is “Sensor Intelligence.”

WORLDWIDE PRESENCE:

Contacts and other locations –www.sick.com