



TIM781S-2174104

TiM-S

SAFETY LASER SCANNERS

SICK
Sensor Intelligence.



Ordering information

Type	Part no.
TIM781S-2174104	1096363

Other models and accessories → www.sick.com/TiM-S



Detailed technical data

Features

System part	Sensor
Measurement principle	HDDM ⁺
Application	Indoor
Light source	Infrared (850 nm)
Laser class	1 (IEC 60825-1:2014, EN 60825-1:2014)
Aperture angle	Horizontal 270°
Scanning frequency	15 Hz
Angular resolution	0.33°
Scan field flatness	± 1.5°
Working range	0.05 m ... 25 m (> 90% remission)
Safety-related working range	0.05 m ... 5 m (At 5% remission)
Blind zone	0 m ... 0.05 m
Scanning range	At 10% remission 8 m

Mechanics/electronics

Connection type	1 x "Ethernet" connection, 4-pin M12 female connector 1 x connection "Power", 12-pin, M12 male connector 1 x Micro USB female connector, type B
Supply voltage	9 V DC ... 28 V DC
Power consumption	Typ. 4 W, 16 W with 4 max. loaded digital outputs
Output current	≤ 100 mA
Housing color	Yellow
Enclosure rating	IP67, applies only when the plastic cover of the "Aux interface" is closed (IEC 60529:1989+AMD1:1999+AMD2:2013)

Protection class	III (IEC 61140:2016-1)
Weight	250 g, without connecting cables
Dimensions (L x W x H)	60 mm x 60 mm x 86 mm
MTBF	> 100 years

Safety-related parameters

Category	B (EN ISO 13849-1:2015)
Performance level	PL b (EN ISO 13849-1:2015)
Performance class SRS/SRSS	B (IEC TS 62998-1:2019)
T_M (mission time)	20 years (EN ISO 13849-1:2015)
Conformities	EN ISO 13849-1:2015, ANSI/ITSDF B56.5:2012, IEC TS 62998-1:2019, EN ISO 13482:2014, EN ISO 13855:2010
MTTF_D	100 years, at 25 °C ambient temperature (EN ISO 13849-1:2015)

Performance

Response time	1 scan, typ. 67 ms 2 scans, ≤ 134 ms ¹⁾
Detectable object shape	Almost any
Systematic error	± 60 mm ²⁾
Statistical error	< 20 mm ²⁾
Safety-related statistical error	< 100 mm (4,4 σ)
Integrated application	Protective field evaluation with flexible fields Output of measurement data
Protective field tolerance	100 mm, 0.66° (DIN CLC/TS 62046:2009, 5% remission)
Number of field sets	16 field triples (48 protective fields)
Simultaneous evaluation cases	3 simultaneous protective fields (per field set)

¹⁾ At +45° to +225° of the working range; max. 150 ms at -45° to +45° of the working range.

²⁾ Typical value at 90% remission up to maximum scanning range; real value depends on ambient conditions.

Interfaces

Ethernet	✓, TCP/IP
USB	✓
Remark	Micro USB
Function	Parameterization
Digital inputs	4 (PNP, for field set switching)
Digital outputs	3 (PNP, to display a protective field violation, additional 1 x "Device Ready")
Delay time	67 ms ... 30,000 ms (configurable)
Dwell time	67 ms ... 600,052 ms (configurable)
Optical indicators	2 LEDs (ON, "device ready")

Ambient data

Object remission	≥ 5 % (reflectors) ¹⁾
Electromagnetic compatibility (EMC)	
Emitted radiation	Residential area (IEC 61000-6-3:2006+AMD1:2010)
Electromagnetic immunity	Industrial environment (IEC 61000-6-2:2005)
Vibration resistance	
Sine resonance scan	10 Hz ... 1,000 Hz ²⁾
Sine test	10 Hz ... 500 Hz, 5 g, 10 frequency cycles ²⁾
Noise test	10 Hz ... 250 Hz, 4.24 g RMS, 5 h ³⁾
Shock resistance	50 g, 11 ms, ± 3 single shocks/axis ⁴⁾ 25 g, 6 ms, ± 1,000 continuous shocks/axis ⁴⁾ 50 g, 3 ms, ± 5,000 continuous shocks/axis ⁴⁾
Ambient operating temperature	-25 °C ... +50 °C ⁵⁾
Storage temperature	-40 °C ... +75 °C ⁵⁾
Switch-on temperature	-10 °C ... +50 °C
Temperature change	-25 °C ... +50 °C, 10 cycles ⁶⁾
Damp heat	+25 °C ... +55 °C, 95 % RH, 6 cycles ⁷⁾
Permissible relative humidity	
Operation	< 80 %, Non-condensing (EN 60068-2-30:2005)
Storage	≤ 90 %, Non-condensing (EN 60068-2-30:2005)
Ambient light immunity	80,000 lx 3,000 lx, With direct light

¹⁾ When using reflectors, observe notes in the operating instructions.

²⁾ IEC 60068-2-6:2007.

³⁾ IEC 60068-2-64:2008.

⁴⁾ IEC 60068-2-27:2008.

⁵⁾ IEC 60068-2-14:2009.

⁶⁾ EN 60068-2-14:2009.

⁷⁾ EN 60068-2-30:2005.

General notes

Note on use	The TIM781S is a safety-related sensor that is suitable for use in the following applications: Hazardous area, hazardous point, and access protection as well as mobile hazardous area protection (protection of automated guided vehicles and mobile platforms). The sensor must only ever be used within the limits of the prescribed and specified technical data and operating conditions.
--------------------	--

Classifications

eCl@ss 5.0	27270990
eCl@ss 5.1.4	27270990
eCl@ss 6.0	27270913
eCl@ss 6.2	27270913
eCl@ss 7.0	27270913
eCl@ss 8.0	27270913
eCl@ss 8.1	27270913
eCl@ss 9.0	27270913

eCl@ss 10.0	27270913
eCl@ss 11.0	27270913
eCl@ss 12.0	27270913
ETIM 5.0	EC002550
ETIM 6.0	EC002550
ETIM 7.0	EC002550
ETIM 8.0	EC002550
UNSPSC 16.0901	41111615

Dimensional drawing (Dimensions in mm (inch))

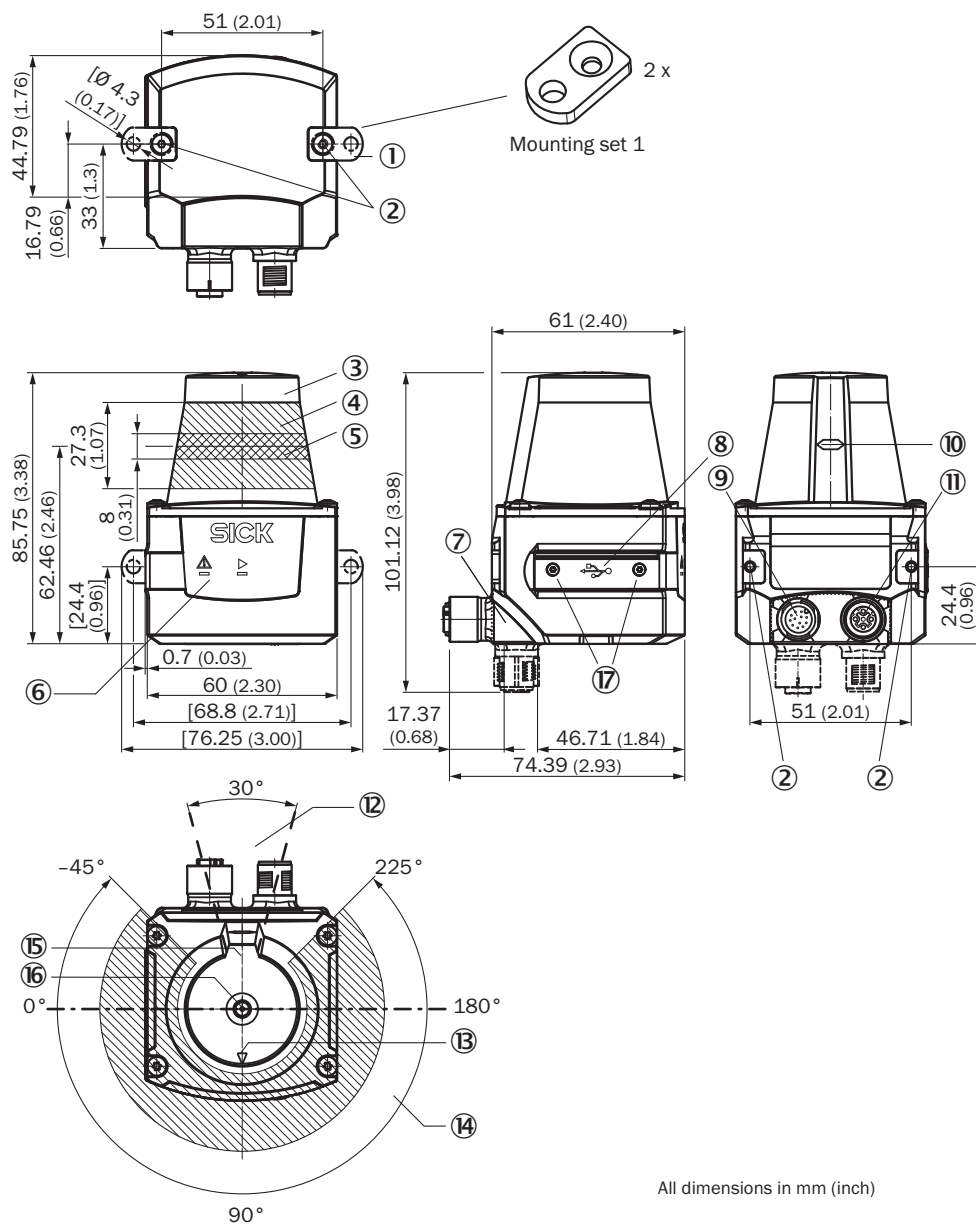

All dimensions in mm (inch)

- ① 2 x straight plates with M3 x 4 mm screw (included in delivery)
- ② M3 threaded mounting hole, 2.8 mm deep (blind hole thread), max. tightening torque 0.8 Nm
- ③ Optical hood
- ④ Receiving range (light inlet)
- ⑤ Transmission range (light emission)
- ⑥ Red and green LED (status displays)
- ⑦ Swivel connector unit
- ⑧ Micro USB port, behind the black rubber plate ("Aux interface" connection for configuration with PC)
- ⑨ "Power/inputs and outputs" connection, 12-pin M12 male connector
- ⑩ Marking for the position of the light emission level
- ⑪ 4-pin M12 female connector: not assigned
- ⑫ Area in which no reflective surfaces are allowed for mounted devices
- ⑬ Bearing marking to support alignment (90° axis)
- ⑭ Aperture angle 270° (scanning angle)
- ⑮ Internal reference target
- ⑯ Measurement origin
- ⑰ 2 x countersunk screw (Torx TX 6) M2 x 4 mm

Working range diagram

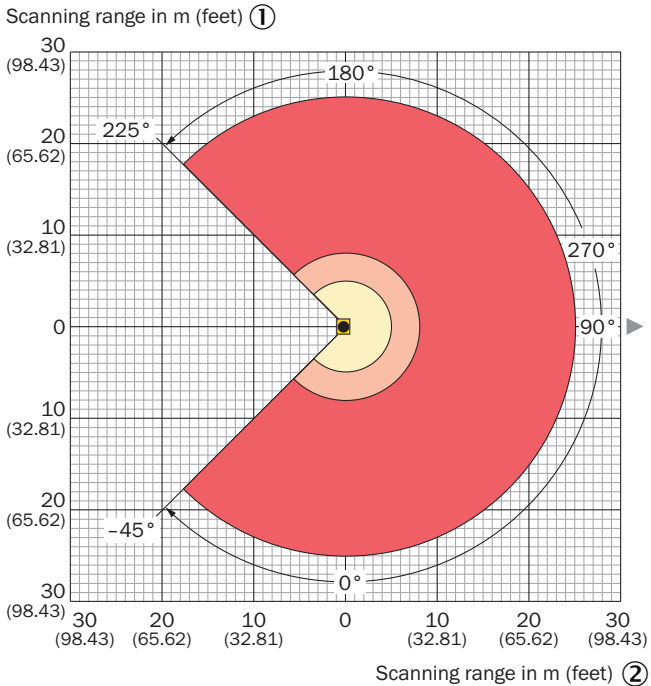

- Range for **not safety-related** detection at > 90% remission: 0.05 m (0.17 feet) to max. 25 m (82.02 feet) ③
- Range for **not safety-related** detection 10% remission: 0.05 m (0.17 feet) to max. 8 m (26.25 feet) ④
- Range for **safety-related** detection at 5% remission: 0.05 m (0.17 feet) to max. 5 m (16.40 feet) ⑤

Attention! From the measurement origin up to a distance of 0.05 m (0.17 feet) no objects are detected (blind zone!) over the entire radial field of view (scanning range of 270°). ⑥

- ① Scanning range in meters (feet)
- ② Scanning range in meters (feet)
- ③ Scanning range for non safety-related detection at > 90% remission: 0.05 m to max 25 m
- ④ Scanning range for non safety-related detection at > 10% remission: 0.05 m to max. 8 m
- ⑤ Scanning range for safety-related detection at 5% remission: 0.05 m to max. 5 m
- ⑥ **WARNING!** No objects will be detected within a range of 0.05 m from the measurement origin and across the entire radial field of view (scanning range of 270°) (blind zone!).

Connection type

Ethernet

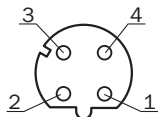

M12 female connector, 4-pin, D-coded

- ① TX+
- ② RX+
- ③ TX-
- ④ RX-

PIN assignment

Power I/O connection

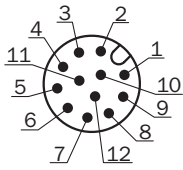



Connecting cable with male connector or M12 male connector, 12-pin, A-coded

- ① GND
- ② DC 9 V ... 28 V
- ③ In₁
- ④ In₂
- ⑤ OUT1
- ⑥ OUT2
- ⑦ OUT3
- ⑧ OUT4
- ⑨ PNP: INGND, NPN: IN 9 V ... 28 V
- ⑩ In3
- ⑪ In4
- ⑫ nc

Recommended accessories

Other models and accessories → www.sick.com/TiM-S

	Brief description	Type	Part no.
Mounting brackets and plates			
	Mounting kit with shock absorber, Anodized aluminum, mounting hardware included	Mounting kit	2086074
Plug connectors and cables			
	Head A: female connector, M12, 12-pin, straight, A-coded Head B: Flying leads Cable: Power, I/O, PUR, shielded, 10 m	YF2A6B-100XXXXLEAX	6054973
	Head A: male connector, USB-A Head B: male connector, Micro-B Cable: USB 2.0, unshielded, 2 m	USB cable	6036106

Recommended services

Additional services → www.sick.com/TiM-S

	Type	Part no.
Maintenance		
<ul style="list-style-type: none"> • Product area: 2D LiDAR sensors, 3D LiDAR sensors • Range of services: Inspection, analysis and restoring of defined functions, Inspection and adaptation of basic settings, parameters of field application, filters for raw data output, and product-specific configuration • Duration: Additional work will be invoiced separately • Travel expenses: The prices do not include travel costs such as hotel, flight, travel time and expenses. 	Maintenance LMS/MRS/NAV/TiM/LRS/multiScan	1682593
Commissioning		
<ul style="list-style-type: none"> • Product area: 2D LiDAR sensors, 3D LiDAR sensors • Range of services: Inspection of connection, fine adjustment, configuration of monitored areas, configuration and optimization of parameters as well as tests, Setup of previously defined functions of basic settings, parameters of field application, filters for raw data output and product-specific configuration • Travel expenses: The prices do not include travel costs such as hotel, flight, travel time and expenses. • Duration: Additional work will be invoiced separately 	Commissioning LMS/MRS/NAV/TiM/LRS/multiScan (Prime package)	1680672
Extended warranty		
<ul style="list-style-type: none"> • Product area: Identification solutions, machine vision, Distance sensors, Detection and ranging solutions • Range of services: The services correspond to the scope of the statutory manufacturer warranty (SICK general terms of delivery). • Duration: Five-year warranty from delivery date. 	Extended warranty for a total of five years from delivery date	1680671

SICK AT A GLANCE

SICK is one of the leading manufacturers of intelligent sensors and sensor solutions for industrial applications. A unique range of products and services creates the perfect basis for controlling processes securely and efficiently, protecting individuals from accidents and preventing damage to the environment.

We have extensive experience in a wide range of industries and understand their processes and requirements. With intelligent sensors, we can deliver exactly what our customers need. In application centers in Europe, Asia and North America, system solutions are tested and optimized in accordance with customer specifications. All this makes us a reliable supplier and development partner.

Comprehensive services complete our offering: SICK LifeTime Services provide support throughout the machine life cycle and ensure safety and productivity.

For us, that is “Sensor Intelligence.”

WORLDWIDE PRESENCE:

Contacts and other locations –www.sick.com