



# KT5G-2P1211

KT5

CONTRAST SENSORS

**SICK**  
Sensor Intelligence.



Illustration may differ



### Ordering information

Type	Part no.
KT5G-2P1211	1015999

Other models and accessories → [www.sick.com/KT5](http://www.sick.com/KT5)

### Detailed technical data

#### Features

<b>Dimensions (W x H x D)</b>	30.4 mm x 53 mm x 80 mm
<b>Sensing distance</b>	≤ 20 mm <sup>1)</sup>
<b>Housing design</b>	Rectangular
<b>Light source</b>	LED, green <sup>2)</sup>
<b>Wave length</b>	520 nm
<b>Light emission</b>	Long and short side of housing, exchangeable
<b>Light spot size</b>	1.5 mm x 5.5 mm
<b>Light spot direction</b>	Vertical <sup>3)</sup>
<b>Adjustment</b>	Potentiometer
<b>Output function</b>	Light/dark switching

<sup>1)</sup> From leading edge of lens.

<sup>2)</sup> Average service life: 100,000 h at T<sub>J</sub> = +25 °C.

<sup>3)</sup> In relation to long side of housing.

#### Mechanics/electronics

<b>Supply voltage</b>	10 V DC ... 30 V DC <sup>1)</sup>
<b>Ripple</b>	≤ 5 V <sub>pp</sub> <sup>2)</sup>
<b>Current consumption</b>	< 80 mA <sup>3)</sup>
<b>Switching frequency</b>	10 kHz <sup>4)</sup>
<b>Response time</b>	50 μs <sup>5)</sup>

<sup>1)</sup> Limit values when operated in short-circuit protected network: max. 8 A.

<sup>2)</sup> May not exceed or fall below U<sub>v</sub> tolerances.

<sup>3)</sup> Without load.

<sup>4)</sup> With light/dark ratio 1:1.

<sup>5)</sup> Signal transit time with resistive load.

<sup>6)</sup> Short-circuit-proof.

<sup>7)</sup> Reference voltage DC 50 V.

<b>Switching output</b>	PNP
<b>Switching output (voltage)</b>	PNP: HIGH = $U_V \leq 2 \text{ V}$ / LOW approx. 0 V
<b>Switching mode</b>	Light/dark switching
<b>Output current <math>I_{\text{max}}</math></b>	100 mA <sup>6)</sup>
<b>Connection type</b>	Male connector M12, 4-pin
<b>Protection class</b>	II <sup>7)</sup>
<b>Circuit protection</b>	$U_V$ connections, reverse polarity protected Output Q short-circuit protected Interference pulse suppression
<b>Enclosure rating</b>	IP67
<b>Weight</b>	400 g
<b>Housing material</b>	Metal, zinc diecast

- 1) Limit values when operated in short-circuit protected network: max. 8 A.
- 2) May not exceed or fall below  $U_V$  tolerances.
- 3) Without load.
- 4) With light/dark ratio 1:1.
- 5) Signal transit time with resistive load.
- 6) Short-circuit-proof.
- 7) Reference voltage DC 50 V.

#### Ambient data

<b>Ambient operating temperature</b>	-10 °C ... +55 °C
<b>Ambient temperature, storage</b>	-25 °C ... +75 °C
<b>Shock load</b>	According to IEC 60068
<b>UL File No.</b>	NRKH.E181493 & NRKH7.E181493

#### Classifications

<b>eCl@ss 5.0</b>	27270906
<b>eCl@ss 5.1.4</b>	27270906
<b>eCl@ss 6.0</b>	27270906
<b>eCl@ss 6.2</b>	27270906
<b>eCl@ss 7.0</b>	27270906
<b>eCl@ss 8.0</b>	27270906
<b>eCl@ss 8.1</b>	27270906
<b>eCl@ss 9.0</b>	27270906
<b>eCl@ss 10.0</b>	27270906
<b>eCl@ss 11.0</b>	27270906
<b>eCl@ss 12.0</b>	27270906
<b>ETIM 5.0</b>	EC001820
<b>ETIM 6.0</b>	EC001820
<b>ETIM 7.0</b>	EC001820
<b>ETIM 8.0</b>	EC001820
<b>UNSPSC 16.0901</b>	39121528

### Dimensional drawing (Dimensions in mm (inch))

#### KT5-2 Potentiometer

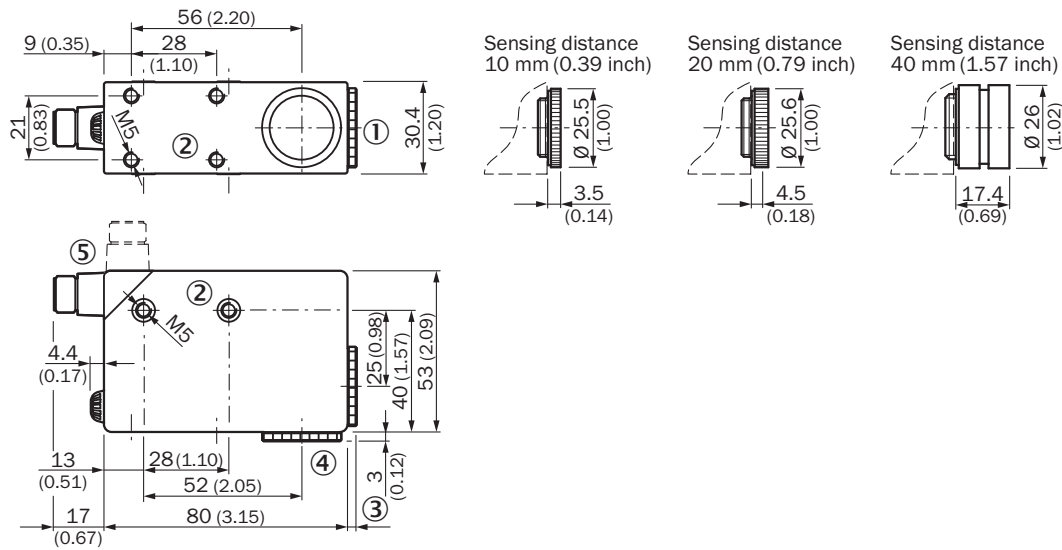

- ① Lens (light transmission), can be exchanged for pos. 4
- ② M5 threaded mounting hole, 5.5 mm deep
- ③ See dimensional drawings of lenses
- ④ Blind screw can be replaced by pos. 1
- ⑤ Connector M12 (rotatable up to 90°)

### Adjustments

#### KT5-2 Potentiometer

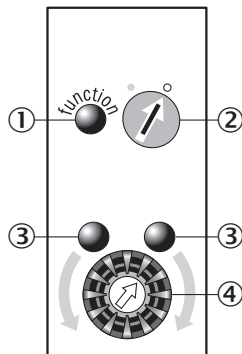

- ① Function signal indicator (yellow)
- ② Pre-selection switch (light/dark switching)
- ③ Switching threshold adjustment
- ④ Installation aid (green)

## Connection diagram

Cd-327

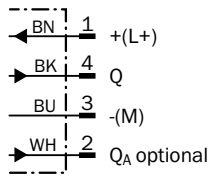

## Concept of operation

KT5-2 Potentiometer

### 1. Select switching function (light/dark)

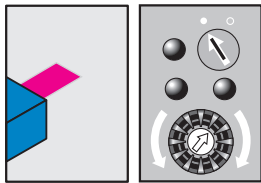

Turn the rotary switch to the desired position.

- = light switching
- = dark switching

### 2. Position mark

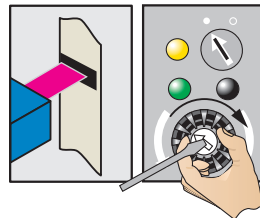

Turn potentiometer in the direction shown (green LED illuminates) until the yellow LED status changes and the green LED opposite illuminates.

### 3. Position background

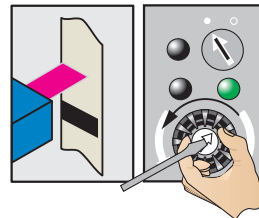

Gradually turn back the potentiometer (count the number of turns) until the yellow LED changes status again and illuminates.

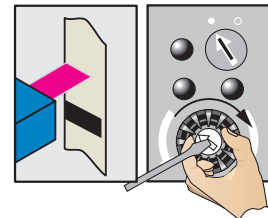

Turn the potentiometer forward again by half the number of turns to ensure that the switching threshold is optimally set.

## Example

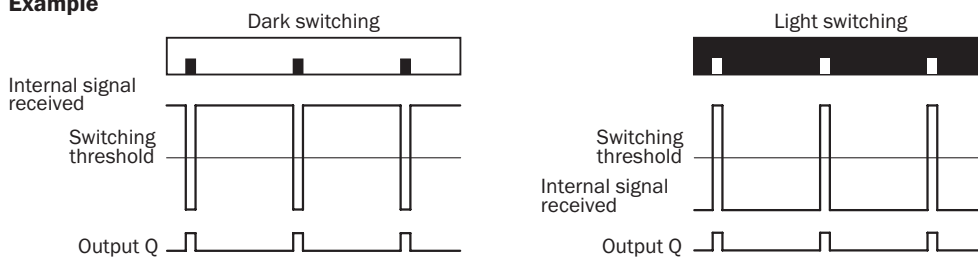

## Switching characteristics

The switching threshold is set in the center between the background and the mark.

### Sensing distance

Sensing distance

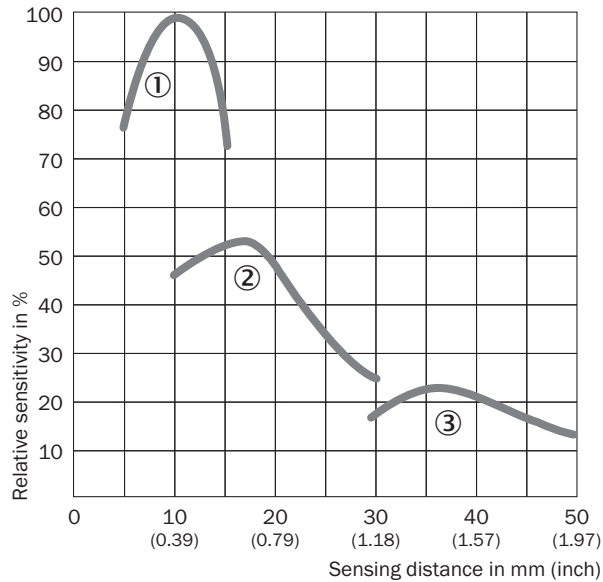











- ① Sensing distance 10 mm
- ② Sensing distance 20 mm
- ③ Sensing distance 40 mm

### Recommended accessories

Other models and accessories → [www.sick.com/KT5](http://www.sick.com/KT5)

	Brief description	Type	Part no.
<b>Lenses and accessories</b>			
	Lens, 40 mm sensing distance, M20 x 0.75	OBJ-210	2010945
	Lens, 10 mm sensing distance, M20 x 0.75	OBJ-211	1004936
	Lens, 20 mm sensing distance, M20 x 0.75	OBJ-212	1011506
<b>Universal bar clamp systems</b>			
		BEF-KHS-G01	2022464
		BEF-KHS-K01	2022718
		BEF-KHS-KH1	2022726
		BEF-MS12G-A	4056054
		BEF-MS12G-B	4056055

	Brief description	Type	Part no.
		BEF-MS12L-A	4056052
		BEF-MS12L-B	4056053
Plug connectors and cables			
		YF2A14-020VB3XLEAX	2096234
		YF2A14-050VB3XLEAX	2096235
		YF2A14-100VB3XLEAX	2096236
		YF2A14-150VB3XLEAX	2096237
		YG2A14-020VB3XLEAX	2095895
		YG2A14-050VB3XLEAX	2095897
		YG2A14-100VB3XLEAX	2095898
		DOS-1204-G	6007302
		DOS-1204-W	6007303

## SICK AT A GLANCE

SICK is one of the leading manufacturers of intelligent sensors and sensor solutions for industrial applications. A unique range of products and services creates the perfect basis for controlling processes securely and efficiently, protecting individuals from accidents and preventing damage to the environment.

We have extensive experience in a wide range of industries and understand their processes and requirements. With intelligent sensors, we can deliver exactly what our customers need. In application centers in Europe, Asia and North America, system solutions are tested and optimized in accordance with customer specifications. All this makes us a reliable supplier and development partner.

Comprehensive services complete our offering: SICK LifeTime Services provide support throughout the machine life cycle and ensure safety and productivity.

For us, that is “Sensor Intelligence.”

## WORLDWIDE PRESENCE:

Contacts and other locations –[www.sick.com](http://www.sick.com)