

# DAC82001 16-Bit, Low-Glitch, Single-Channel Voltage-Output, Unbuffered DAC

## 1 Features

- 16-bit performance: 1-LSB DNL and 2-LSB INL
- Low glitch energy: 0.5 nV-s
- Fast settling: 1  $\mu$ s
- Wide power supply: 2.7 V to 5.5 V
- Wide reference range: 2.0 V to  $V_{DD}$
- Low power: 250  $\mu$ A at 5.0 V
- 3-wire serial peripheral interface (SPI) up to 50-MHz
- Reset to zero scale or midscale
- 1.62-V  $V_{IH}$  with  $V_{DD} = 5.5$  V
- Temperature range:  $-40^{\circ}\text{C}$  to  $+85^{\circ}\text{C}$
- Package: Tiny 10-pin WSON

## 2 Applications

- [Oscilloscope \(DSO\)](#)
- [Battery test](#)
- [Semiconductor test](#)
- [Ultrasound scanner](#)
- [DC power supply, ac source, electronic load](#)

## 3 Description

The 16-bit DAC82001 is a highly accurate, low-power, single-channel digital-to-analog converter (DAC) with an unbuffered voltage output.

The DAC82001 works with 3.3-V and 5-V supplies and offers linearity of 1-LSB DNL and 2-LSB INL. The high accuracy combined with a tiny package make the device an excellent choice for applications such as gain and offset calibration, voltage set point generation, and power-supply control. The DAC82001 incorporates a power-on-reset (POR) circuit. The POR circuit makes sure that the DAC output powers up at zero scale or midscale based on the status of RSTSEL pin, and remains at that scale until a valid code is written to the device. All internal registers are asynchronously reset after the  $\overline{\text{RESET}}$  pin is pulled low.

The DAC82001 uses a versatile, three-wire serial peripheral interface (SPI) that operates at clock rates of up to 50 MHz.

### Package Information

PART NUMBER	PACKAGE <sup>(1)</sup>	BODY SIZE (NOM)
DAC82001	DRX (WSON, 10)	2.50 mm $\times$ 2.50 mm

(1) For all available packages, see the package option addendum at the end of the data sheet.

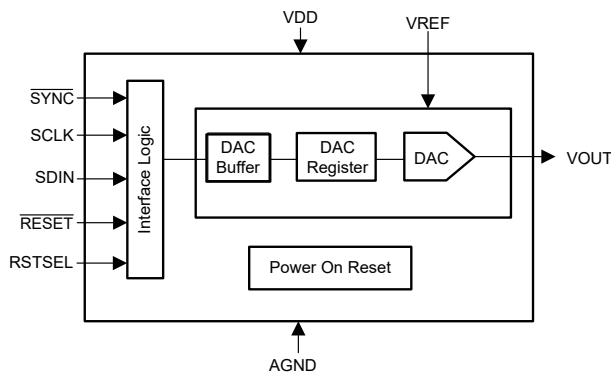

Functional Block Diagram

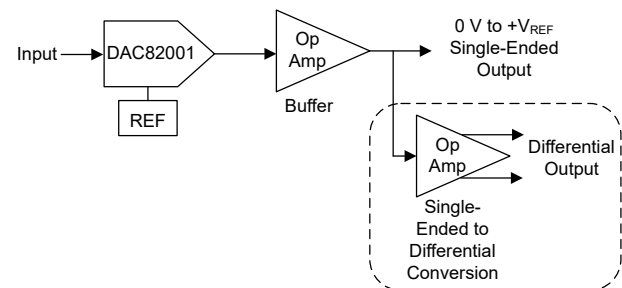

DAC82001 for Generating Time Gain Compensation (TGC) Control



## Table of Contents

<b>1 Features</b> .....	1	7.4 Device Functional Modes.....	13
<b>2 Applications</b> .....	1	7.5 Programming.....	14
<b>3 Description</b> .....	1	7.6 Register Maps.....	15
<b>4 Revision History</b> .....	2	<b>8 Application and Implementation</b> .....	17
<b>5 Pin Configuration and Functions</b> .....	3	8.1 Application Information.....	17
<b>6 Specifications</b> .....	4	8.2 Typical Applications.....	17
6.1 Absolute Maximum Ratings.....	4	8.3 Power Supply Recommendations.....	21
6.2 ESD Ratings.....	4	8.4 Layout.....	21
6.3 Recommended Operating Conditions.....	4	<b>9 Device and Documentation Support</b> .....	22
6.4 Thermal Information.....	4	9.1 Documentation Support.....	22
6.5 Electrical Characteristics.....	5	9.2 Receiving Notification of Documentation Updates....	22
6.6 Timing Requirements.....	6	9.3 Support Resources.....	22
6.7 Timing Diagram .....	6	9.4 Trademarks.....	22
6.8 Typical Characteristics.....	7	9.5 Electrostatic Discharge Caution.....	22
<b>7 Detailed Description</b> .....	11	9.6 Glossary.....	22
7.1 Overview.....	11	<b>10 Mechanical, Packaging, and Orderable Information</b> .....	22
7.2 Functional Block Diagram.....	11		
7.3 Feature Description.....	12		

## 4 Revision History

NOTE: Page numbers for previous revisions may differ from page numbers in the current version.

<b>Changes from Revision * (September 2022) to Revision A (November 2022)</b>	<b>Page</b>
• Changed device status from advanced information (preview) to production data (active).....	1

## 5 Pin Configuration and Functions

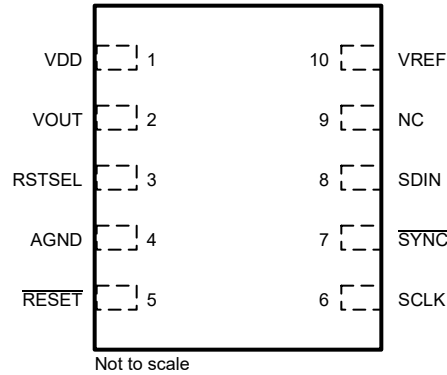

**Figure 5-1. DRX (10-Pin WSON) Package, Top View**

**Table 5-1. Pin Functions**

PIN		TYPE	DESCRIPTION
NAME	NO.		
AGND	4	Ground	Ground reference point for all circuitry on the device.
NC	9	—	Do not connect
$\overline{\text{RESET}}$	5	Input	Asynchronous reset. Active low. If $\overline{\text{RESET}}$ is low, all DAC channels reset either to zero-scale (RSTSEL = AGND) or to midscale (RSTSEL = V <sub>DD</sub> ).
RSTSEL	3	Input	Reset select pin. DAC powers up to zero scale if RSTSEL = AGND. DAC powers up to midscale if RSTSEL = V <sub>DD</sub> .
SCLK	6	Input	Serial interface clock of SPI.
SDIN	8	Input	Serial interface data input of SPI. Data are clocked into the input shift register on each falling edge of the SCLK pin.
$\overline{\text{SYNC}}$	7	Input	Serial data enable of SPI. Active low. This input is the frame-synchronization signal for the serial data. When the signal goes low, the serial interface input shift register is enabled.
VDD	1	Power	Analog supply voltage (2.7 V to 5.5 V)
VOUT	2	Output	Analog output voltage from DAC
VREF	10	Input	This pin is the external reference input to the device.

## 6 Specifications

### 6.1 Absolute Maximum Ratings

over operating free-air temperature range (unless otherwise noted)<sup>(1)</sup>

			MIN	MAX	UNIT
V <sub>S</sub>	Input voltage	VDD to AGND	-0.3	6	V
		VREF to AGND	-0.3	V <sub>DD</sub> + 0.3	
		Digital inputs to AGND	-0.3	V <sub>DD</sub> + 0.3	
	Output voltage, VOUT to AGND		-0.3	V <sub>DD</sub> + 0.3	V
	Input current into any digital pin		-10	10	mA
T <sub>J</sub>	Junction temperature		-40	150	°C
T <sub>stg</sub>	Storage temperature		-65	150	°C

- (1) Operation outside the Absolute Maximum Ratings may cause permanent device damage. Absolute Maximum Ratings do not imply functional operation of the device at these or any other conditions beyond those listed under Recommended Operating Conditions. If used outside the Recommended Operating Conditions but within the Absolute Maximum Ratings, the device may not be fully functional, and this may affect device reliability, functionality, performance, and shorten the device lifetime.

### 6.2 ESD Ratings

			VALUE	UNIT
V <sub>(ESD)</sub>	Electrostatic discharge	Human body model (HBM), per ANSI/ESDA/JEDEC JS-001, all pins <sup>(1)</sup>	±1500	V
		Charged device model (CDM), per ANSI/ESDA/JEDEC JS-002, all pins <sup>(2)</sup>	±1000	

- (1) JEDEC document JEP155 states that 500-V HBM allows safe manufacturing with a standard ESD control process.  
 (2) JEDEC document JEP157 states that 250-V CDM allows safe manufacturing with a standard ESD control process.

### 6.3 Recommended Operating Conditions

over operating free-air temperature range (unless otherwise noted)

		MIN	NOM	MAX	UNIT
<b>POWER SUPPLY</b>					
V <sub>S</sub>	Positive supply voltage to ground, VDD to AGND	2.7		5.5	V
<b>DIGITAL INPUTS</b>					
V <sub>IH</sub>	Input high voltage	1.62			V
V <sub>IL</sub>	Input low voltage			0.45	V
<b>REFERENCE INPUT</b>					
V <sub>REF</sub>	Reference voltage to ground, VREF to AGND	2.0		V <sub>DD</sub>	V
<b>TEMPERATURE</b>					
T <sub>A</sub>	Operating temperature	-40		85	°C

### 6.4 Thermal Information

THERMAL METRIC <sup>(1)</sup>		DAC82001	UNIT
		DRX (WSON)	
		10 PINS	
R <sub>θJA</sub>	Junction-to-ambient thermal resistance	99.7	°C/W
R <sub>θJC(top)</sub>	Junction-to-case (top) thermal resistance	49.9	°C/W
R <sub>θJB</sub>	Junction-to-board thermal resistance	35.9	°C/W
Ψ <sub>JT</sub>	Junction-to-top characterization parameter	1.7	°C/W
Ψ <sub>JB</sub>	Junction-to-board characterization parameter	35.7	°C/W

- (1) For information about traditional and new thermal metrics, see the [Semiconductor and IC Package Thermal Metrics application report](#).

## 6.5 Electrical Characteristics

all minimum and maximum values at  $T_A = -40^{\circ}\text{C}$  to  $+85^{\circ}\text{C}$  and all typical values at  $T_A = 25^{\circ}\text{C}$ ,  $2.7\text{ V} \leq V_{DD} \leq 5.5\text{ V}$ ,  $2.0\text{ V} \leq V_{REF} \leq 5.5\text{ V}$ ,  $AGND = 0\text{ V}$ , and digital inputs at  $V_{DD}$  or  $AGND$  (unless otherwise noted)

PARAMETER		TEST CONDITIONS	MIN	TYP	MAX	UNIT
<b>STATIC PERFORMANCE</b>						
	Resolution		16			Bits
INL	Integral nonlinearity		-2	$\pm 0.6$	2	LSB
DNL	Differential nonlinearity		-1	$\pm 0.5$	1	LSB
TUE	Total unadjusted error		-0.06	0.04	0.06	%FSR
	Zero code error		-2.6	0.5	2.6	LSB
	Zero code error temperature coefficient			$\pm 0.02$		ppm/ $^{\circ}\text{C}$
	Gain error		-20	4	20	LSB
	Gain error temperature coefficient			$\pm 0.1$		ppm/ $^{\circ}\text{C}$
<b>OUTPUT CHARACTERISTICS</b>						
$V_O$	Output voltage		0		$V_{REF}$	V
$Z_O$	Output impedance			6.25		k $\Omega$
PSRR DC	Power supply rejection ratio (dc)	DAC at midscale; $V_{DD} = 5\text{ V} \pm 10\%$ , $V_{REF} = 2.5\text{ V}$		5		$\mu\text{V/V}$
<b>DYNAMIC PERFORMANCE</b>						
$t_s$	Output voltage settling time	To 1/2 LSB of FS, $C_L = 10\text{ pF}$		1		$\mu\text{s}$
	Output noise	DAC at midcode, 0.1 Hz to 10 Hz		0.1		$\mu\text{V}_{PP}$
	Output noise density	DAC at midcode, measured at 10 kHz		10		nV/ $\sqrt{\text{Hz}}$
SFDR	Spurious free dynamic range	1-kHz sinusoid at DAC output (unbuffered, full scale), DAC updated at 200 kSPS with 40-kHz low-pass filter, include up to 7th harmonics		-96		dB
THD	Total harmonic distortion	1-kHz sinusoid at DAC output (unbuffered, full scale), DAC updated at 200 kSPS with 40-kHz low-pass filter, include up to 7th harmonics		-91		dB
PSRR AC	Power supply rejection ratio (ac)	DAC at midscale, $V_{REF} = 2.5\text{ V}$ , $V_{DD} = 5\text{ V} \pm 200\text{ mV}$ at 10 kHz		-72		dB
	Code change glitch impulse	$\pm 1$ LSB around major carry		0.5		nV-s
	Digital feedthrough			0.5		nV-s
	Power on glitch magnitude	$C_{LOAD} = 10\text{ pF}$		0.8		V
<b>VOLTAGE REFERENCE INPUT</b>						
	Reference input voltage		2.0		$V_{DD}$	V
$Z_{REF}$	Reference input impedance		5			k $\Omega$
$C_{REF}$	Reference input capacitance			75		pF
<b>DIGITAL INPUTS</b>						
	Hysteresis voltage			0.4		V
	Input current		-5		5	$\mu\text{A}$
	Pin capacitance	Per pin		10		pF
<b>POWER</b>						
$I_{DD}$	Power-supply current	$V_{DD} = 3\text{ V}$		250	350	$\mu\text{A}$
		$V_{DD} = 5\text{ V}$		250	350	
	Power	$V_{DD} = 3\text{ V}$		750	1050	$\mu\text{W}$
		$V_{DD} = 5\text{ V}$		1250	1750	

## 6.6 Timing Requirements

all input signals are specified with  $t_R = t_F = 1 \text{ ns/V}$  and timed from a voltage level of  $(V_{IL} + V_{IH}) / 2$ .  $2.7 \text{ V} \leq V_{DD} \leq 5.5 \text{ V}$ ,  $V_{IH} = 1.62 \text{ V}$ ,  $V_{IL} = 0.15 \text{ V}$ ,  $2.0 \text{ V} \leq V_{REF} \leq 5.5 \text{ V}$ , and  $T_A = -40^\circ\text{C}$  to  $+85^\circ\text{C}$  (unless otherwise noted)

		MIN	NOM	MAX	UNIT
$f_{\text{SCLK}}$	SCLK frequency			50	MHz
$t_{\text{SCLKHIGH}}$	SCLK high time	9			ns
$t_{\text{SCLKLOW}}$	SCLK low time	9			ns
$t_{\text{SDIS}}$	SDIN setup	5			ns
$t_{\text{SDIH}}$	SDIN hold	10			ns
$t_{\text{SYNCS}}$	$\overline{\text{SYNC}}$ falling edge to SCLK falling edge setup	13			ns
$t_{\text{SYNCH}}$	SCLK falling edge to $\overline{\text{SYNC}}$ rising edge	10			ns
$t_{\text{SYNCHIGH}}$	$\overline{\text{SYNC}}$ high time	160			ns
$t_{\text{SYNCSIGNORE}}$	SCLK falling edge to $\overline{\text{SYNC}}$ ignore	15			ns
$t_{\text{DACWAIT}}$	Sequential DAC update wait time	1			$\mu\text{s}$

## 6.7 Timing Diagram

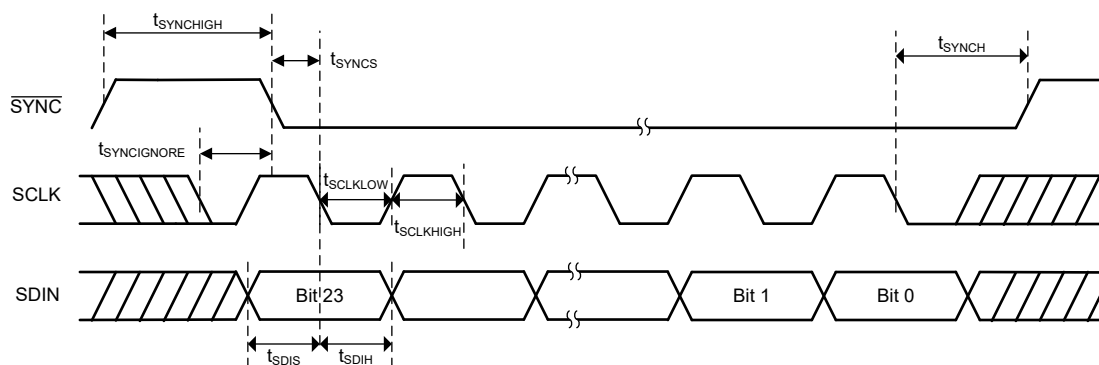
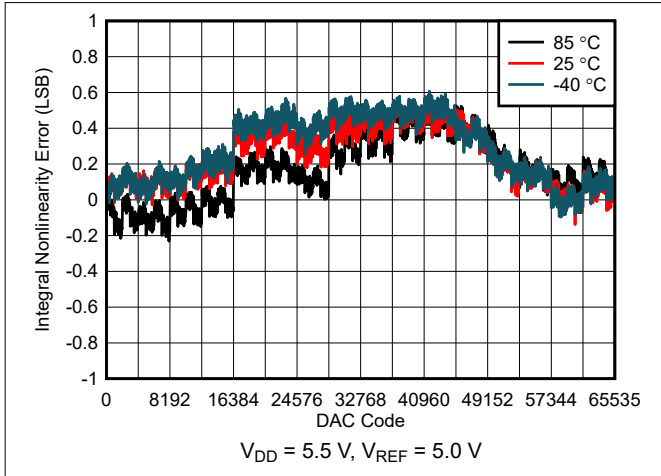

Figure 6-1. Timing Diagram

## 6.8 Typical Characteristics

at  $T_A = 25^\circ\text{C}$ , channel output shown, and DAC outputs unloaded (unless otherwise noted)



**Figure 6-2. Integral Linearity Error vs Digital Input Code**

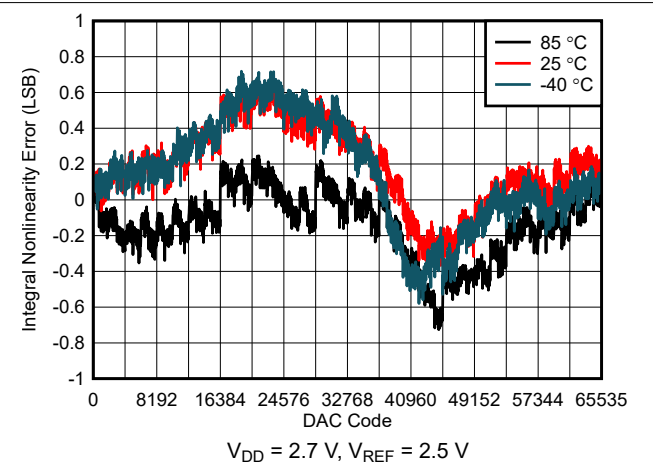

**Figure 6-3. Integrated Linearity Error vs Digital Input Code**

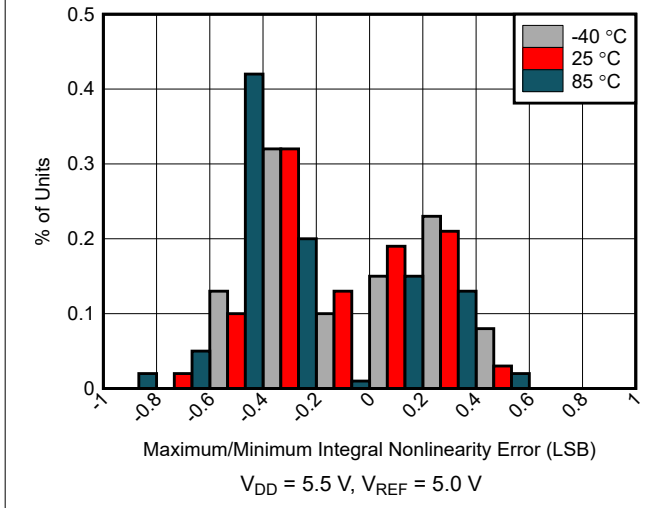

**Figure 6-4. Integral Linearity Error Histogram**

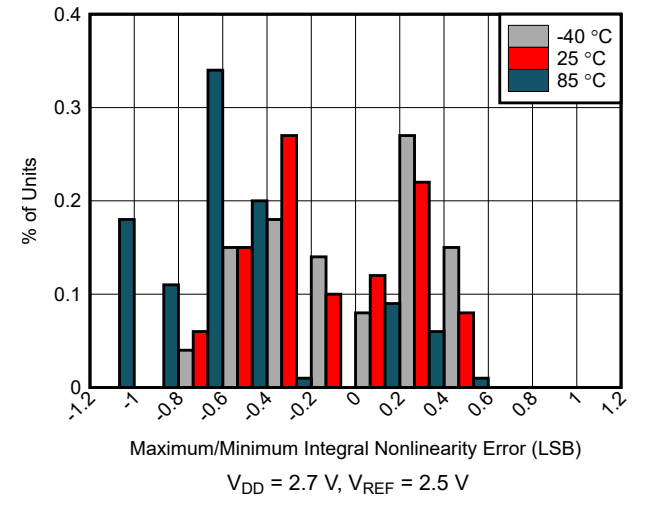

**Figure 6-5. Integrated Linearity Error Histogram**

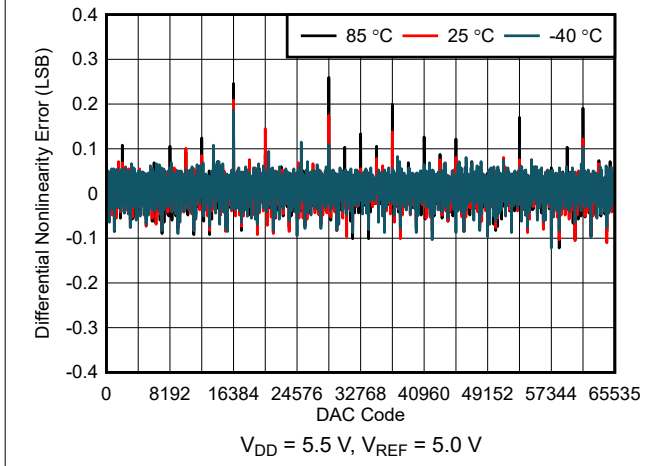

**Figure 6-6. Differential Linearity Error vs Digital Input Code**

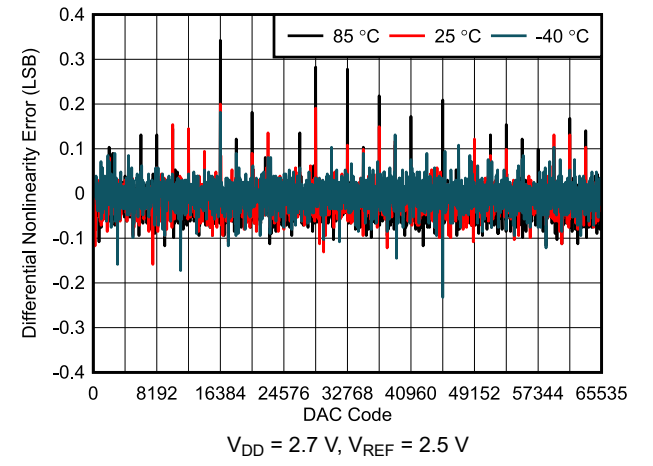

**Figure 6-7. Differential Linearity Error vs Digital Input Code**

### 6.8 Typical Characteristics (continued)

at  $T_A = 25^\circ\text{C}$ , channel output shown, and DAC outputs unloaded (unless otherwise noted)

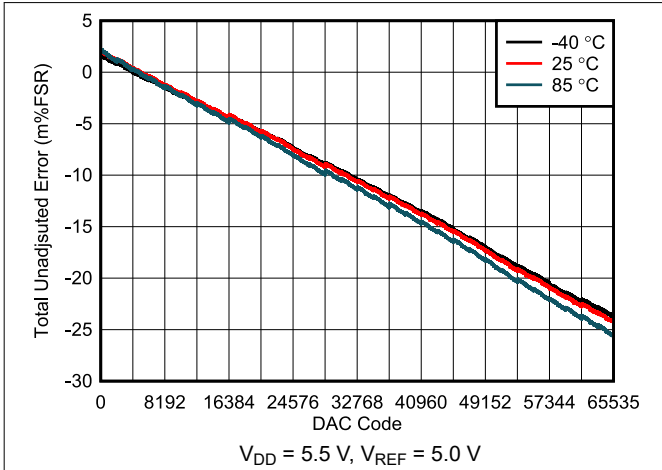

Figure 6-8. Total Unadjusted Error vs Digital Input Code

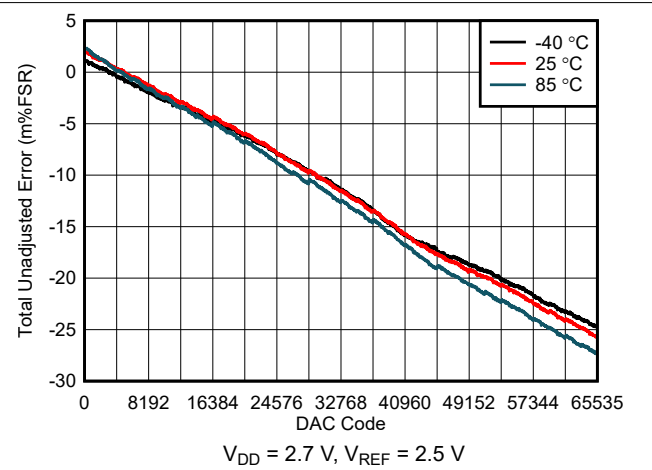

Figure 6-9. Total Unadjusted Error vs Digital Input Code

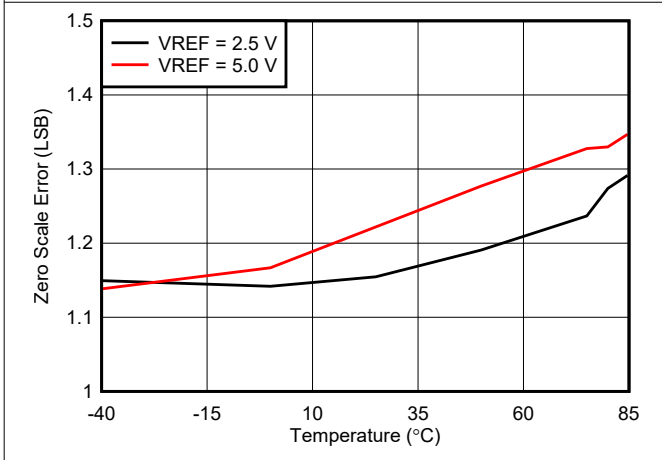

Figure 6-10. Zero-Code Error vs Temperature

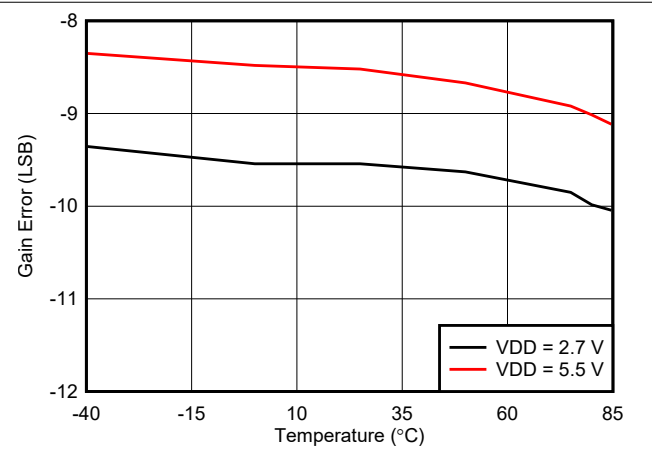

Figure 6-11. Gain Error vs Temperature

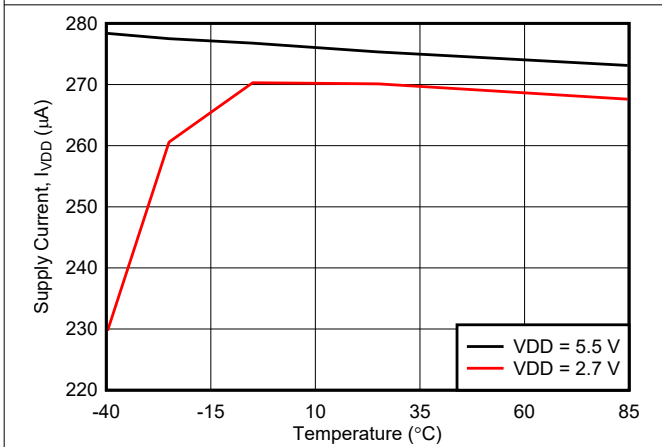

Figure 6-12. Supply Current vs Temperature

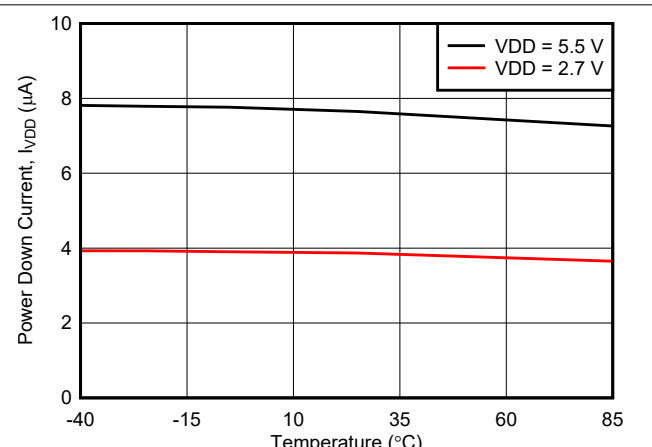
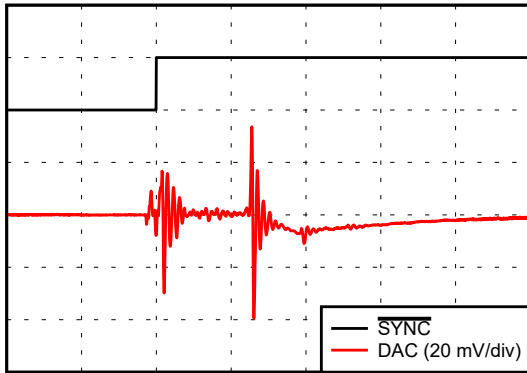

Figure 6-13. Power-down Current vs Temperature



### 6.8 Typical Characteristics (continued)

at  $T_A = 25^\circ\text{C}$ , channel output shown, and DAC outputs unloaded (unless otherwise noted)



Time (100 ns/div)

$V_{DD} = 5.5\text{ V}$ ,  $V_{REF} = 5.0\text{ V}$ ,

DAC code transition from midscale - 1 to midscale LSB

Figure 6-14. Glitch Impulse, Rising Edge, 1-LSB Step

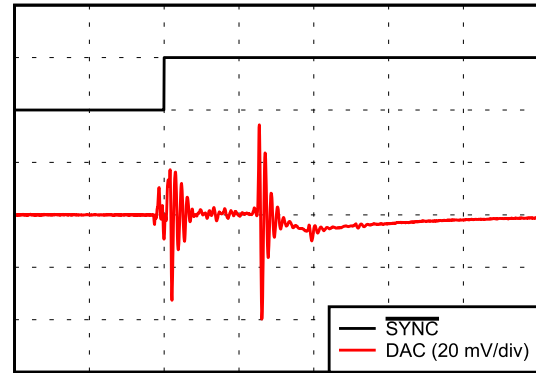

Time (100 ns/div)

$V_{DD} = 5.5\text{ V}$ ,  $V_{REF} = 5.0\text{ V}$ ,

DAC code transition from midscale to midscale - 1 LSB

Figure 6-15. Glitch Impulse, Falling Edge, 1-LSB Step

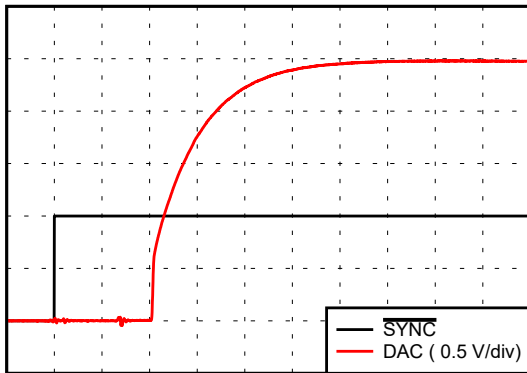

Time (100 ns/div)

$V_{DD} = 2.7\text{ V}$ ,  $V_{REF} = 2.5\text{ V}$

Figure 6-16. Full-Scale Settling Time, Rising Edge

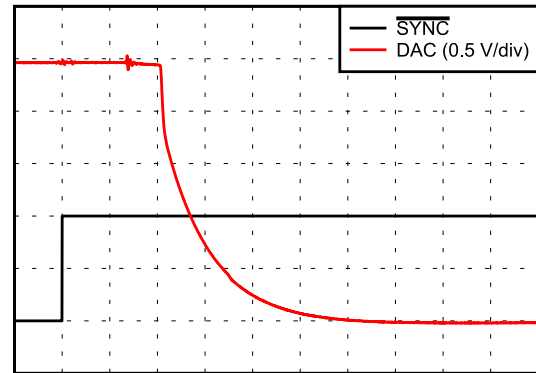

Time (100 ns/div)

$V_{DD} = 2.7\text{ V}$ ,  $V_{REF} = 2.5\text{ V}$

Figure 6-17. Full-Scale Settling Time, Falling Edge

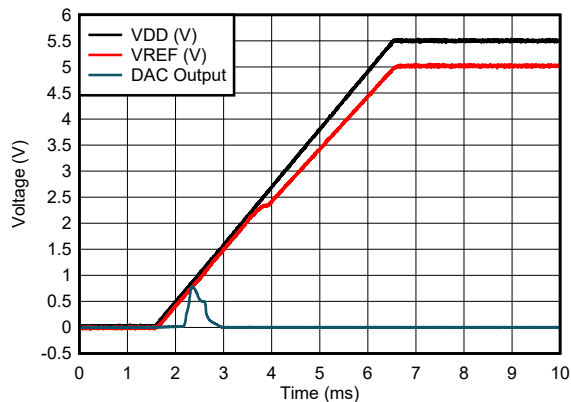

$V_{DD} = 5.5\text{ V}$ ,  $V_{REF} = 5.0\text{ V}$

Figure 6-18. Power-On Glitch

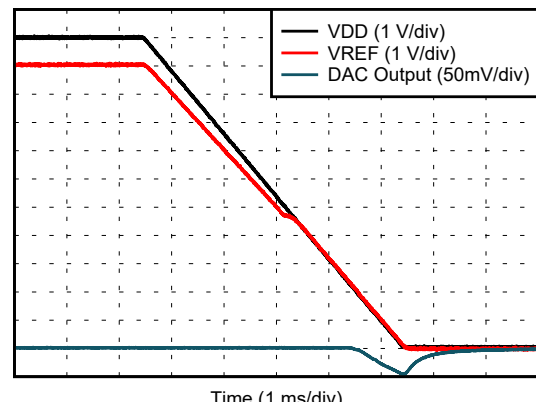

$V_{DD} = 5.5\text{ V}$ ,  $V_{REF} = 5.0\text{ V}$

Figure 6-19. Power-Off Glitch

## 6.8 Typical Characteristics (continued)

at  $T_A = 25^\circ\text{C}$ , channel output shown, and DAC outputs unloaded (unless otherwise noted)

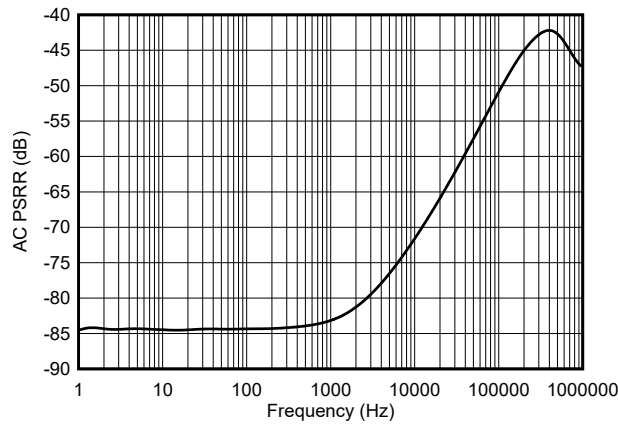

$V_{DD} = 5.5\text{ V}$ , DAC code at midscale

Figure 6-20. Power-Supply Rejection Ratio (PSRR)

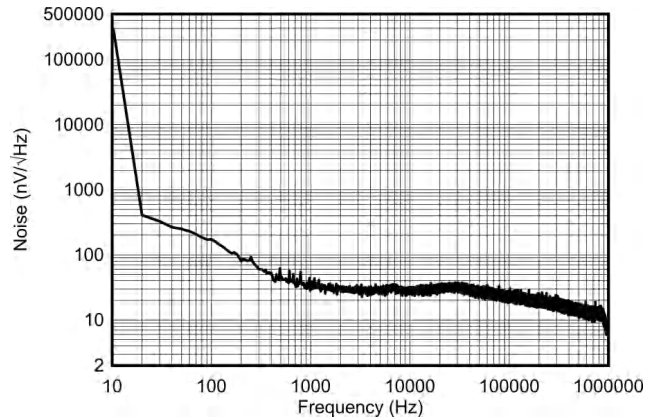

$V_{DD} = 5.5\text{ V}$ ,  $V_{REF} = 5.0\text{ V}$

Figure 6-21. Output Noise Density vs Frequency

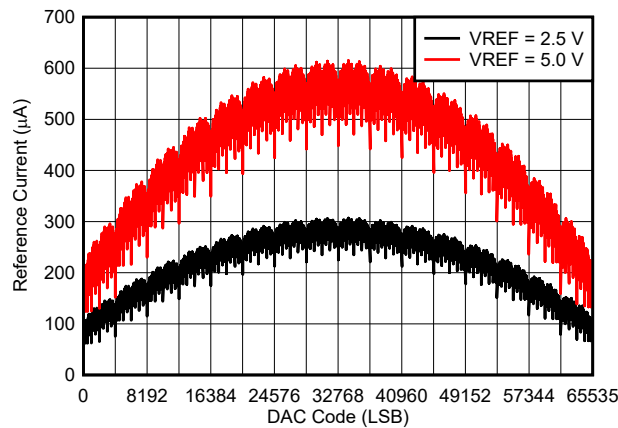
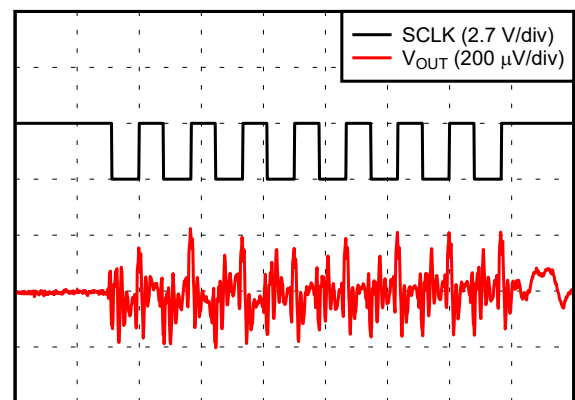

Figure 6-22. Reference Current vs Digital Input Code



Time (100 ns/div)

$V_{DD} = 2.7\text{ V}$ ,  $V_{REF} = 2.5\text{ V}$

Figure 6-23. Clock Feedthrough

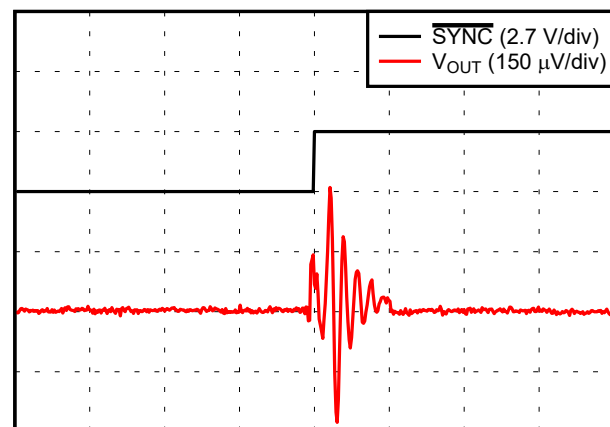

Time (50 ns/div)

$V_{DD} = 2.7\text{ V}$ ,  $V_{REF} = 2.5\text{ V}$

Figure 6-24. Control Feedthrough

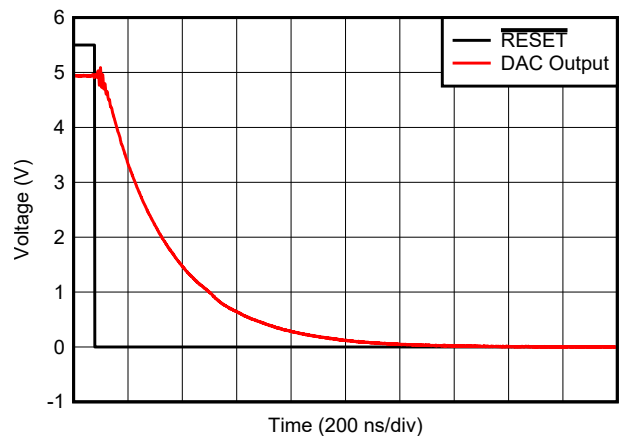

$V_{DD} = 5.5\text{ V}$ ,  $V_{REF} = 5.0\text{ V}$

Figure 6-25. RESET Response

## 7 Detailed Description

### 7.1 Overview

The DAC82001 device is a single-channel, unbuffered voltage output, 16-bit digital-to-analog converter (DAC) operating from a single 3.3-V to 5-V power supply. This converter provides 1-LSB DNL and 2-LSB INL linearity. With a 10-pF load, the output of the DAC82001 settles to  $\frac{1}{2}$  LSB of full scale at 1  $\mu$ s. The glitch impulse of 1-LSB code change around major carry is 0.5 nV-s.

The device incorporates a power-on-reset circuit to make sure that the DAC output powers up at zero scale or midscale, depending on status of the RSTSEL pin, and remains at that scale until a valid code is written to the device. All internal registers are asynchronously reset after the RESET pin is pulled low. Similar to the power-on-reset, the RESET signal sets the DAC output to zero scale or midscale based on the status of the RSTSEL pin.

The digital interface of the DAC82001 uses a 3-wire serial peripheral interface (SPI) that operates at clock rates of up to 50 MHz.

### 7.2 Functional Block Diagram

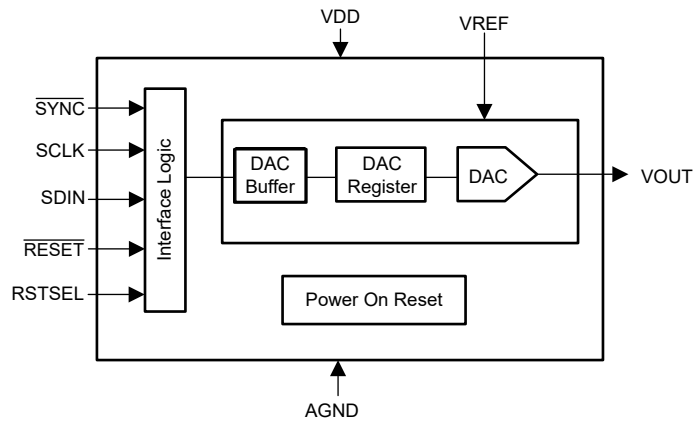

## 7.3 Feature Description

### 7.3.1 Digital-to-Analog Converter (DAC) Architecture

The output channel in the DAC82001 device consists of a segmented R-2R architecture. Figure 7-1 shows a block diagram of the DAC architecture. The four MSBs of the 16-bit data word are decoded to drive 15 switches, E1 to E15. Each of these switches connects one of 15 matched resistors to either AGND or VREF. The remaining 12 bits of the data word drive switches S0 to S11 of a 12-bit voltage mode R-2R ladder network.

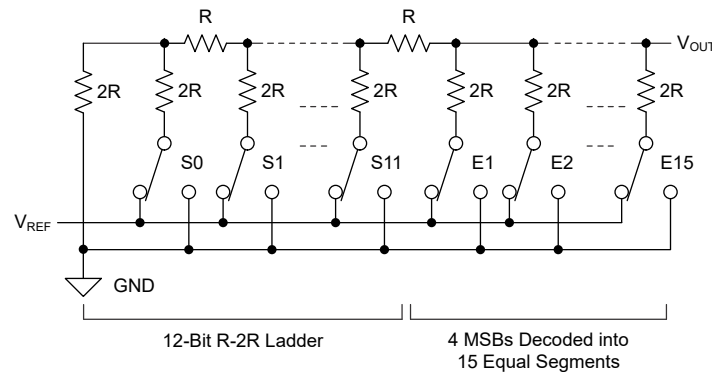

Figure 7-1. DAC82001 DAC Block Diagram

#### 7.3.1.1 DAC Transfer Function

The input data writes to the individual DAC data registers in straight binary format. After a power-on or a reset event, all DAC registers are set to zero code (RSTSEL = AGND) or midscale code (RSTSEL = V<sub>DD</sub>). The DAC transfer function is shown by Equation 1.

$$V_{OUT} = \frac{DAC\_DATA}{2^N} \times V_{REF} \quad (1)$$

where:

- N = 16 (resolution in bits)
- DAC\_DATA = decimal equivalent of the binary code that is loaded to the DAC register (address 8h), DAC\_DATA ranges from 0 to 2<sup>N</sup> – 1
- V<sub>REF</sub> = DAC external reference voltage. V<sub>REF</sub> ranges from 2.0 V to V<sub>DD</sub>

#### 7.3.1.2 DAC Register Structure

Data written to the DAC data registers are initially stored in the DAC buffer registers. The update mode of the DAC output is determined by the status of the DAC\_SYNC\_EN bit (address 2h).

In asynchronous mode (default, DAC\_SYNC\_EN = 0), a write to the DAC buffer register results in an immediate update of the DAC active register. The DAC output (V<sub>OUT</sub> pin) updates on the rising edge of SYNC.

In synchronous mode (DAC\_SYNC\_EN = 1), writing to the DAC buffer register does not automatically update the DAC active register. Instead, the update occurs only after a software LDAC trigger event. A software LDAC trigger generates through the LDAC bit in the TRIGGER register (address 5h).

### 7.3.2 Power-On Reset (POR)

The DAC82001 device includes a power-on reset function that controls the output voltage at power up. After the  $V_{DD}$  supply has been established, a POR event is issued. The POR causes all registers to initialize to default values, and communication with the device is valid only after a 250- $\mu$ s, power-on-reset delay. The default value for all DACs is zero code if RSTSEL = AGND, and midscale code if RSTSEL =  $V_{DD}$ . The DAC channel remains at the power-up voltage until a valid command is written to the channel.

When the device powers up, a POR circuit sets the device to the default mode. Figure 7-2 shows that the POR circuit requires specific  $V_{DD}$  levels to make sure that the internal capacitors discharge and reset the device at power up. To make sure that a POR occurs,  $V_{DD}$  must be less than 0.7 V for at least 1 ms. When  $V_{DD}$  drops to less than 2.2 V but remains greater than 0.7 V (shown as the undefined region in Figure 7-2), the device may or may not reset under all specified temperature and power-supply conditions; in this case, initiate a POR. When  $V_{DD}$  remains greater than 2.2 V, a POR does not occur.

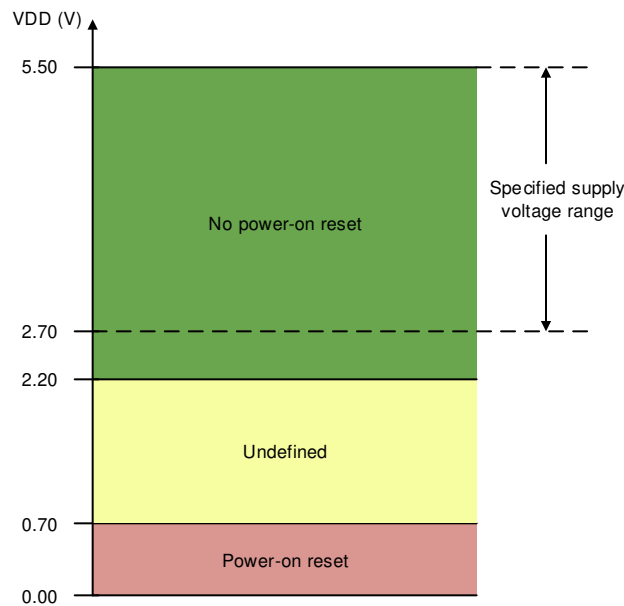

Figure 7-2. Threshold Levels for the  $V_{DD}$  POR Circuit

### 7.3.3 Hardware Reset

The DAC output is asynchronously set to zero code if RSTSEL = AGND, and midscale code if RSTSEL =  $V_{DD}$ , immediately after the  $\overline{\text{RESET}}$  pin is brought low. The  $\overline{\text{RESET}}$  signal resets all internal registers, meaning all registers initialize to default values. Bring the  $\overline{\text{RESET}}$  pin back to high before a write sequence starts. Similar to the POR delay, communication with the device is valid only after a 250- $\mu$ s delay. The default value for the DAC channel remains at the reset voltage until a valid command is written to the channel. The RSTSEL pin can be reconfigured without a power cycle. The DAC output always reflects the current RSTSEL status when the  $\overline{\text{RESET}}$  pin is pulled low.

### 7.3.4 Software Reset

A device software reset event is initiated by writing the reserved code 0x1010 to the SOFT-RESET bits in the TRIGGER register (address 5h). A software reset initiates a POR event.

## 7.4 Device Functional Modes

The DAC82001 has one mode of operation: normal.

In normal mode, the DAC82001 is fully operational. The device translates digital input or reset input to corresponding analog output.

## 7.5 Programming

### 7.5.1 Serial Peripheral Interface (SPI)

The DAC82001 is controlled through a 3-wire serial peripheral interface (SPI) using  $\overline{\text{SYNC}}$ , SCLK, and SDIN. The serial interface operates at up to 50 MHz. The input shift register is 24-bits wide.

Table 7-1 shows the SPI frame format.

**Table 7-1. SPI Frame Format**

BIT	23	22	21	20	19	18	17	16	15	14	13	12	11	10	9	8	7	6	5	4	3	2	1	0	
DESC	$\overline{\text{W}}$	Register Address - Command Byte								16-Bit MSB-Aligned DAC Data															

Serial clock SCLK is a continuous or a gated clock. The first falling edge of  $\overline{\text{SYNC}}$  starts the operation cycle. When  $\overline{\text{SYNC}}$  is high, the SCLK and SDIN signals are blocked. The device internal registers are updated from the shift register on the rising edge of  $\overline{\text{SYNC}}$ .

#### 7.5.1.1 $\overline{\text{SYNC}}$ Interrupt

For SPI operation, the  $\overline{\text{SYNC}}$  line stays low for at least 24 falling edges of SCLK, and the addressed DAC register updates on the  $\overline{\text{SYNC}}$  rising edge. However, if the  $\overline{\text{SYNC}}$  line is brought high before the 24th SCLK falling edge, this event acts as an interrupt to the write sequence. The shift register resets and the write sequence is discarded. As Figure 7-3 shows, the data buffer contents and the DAC register contents do not update, and the operating mode does not change.

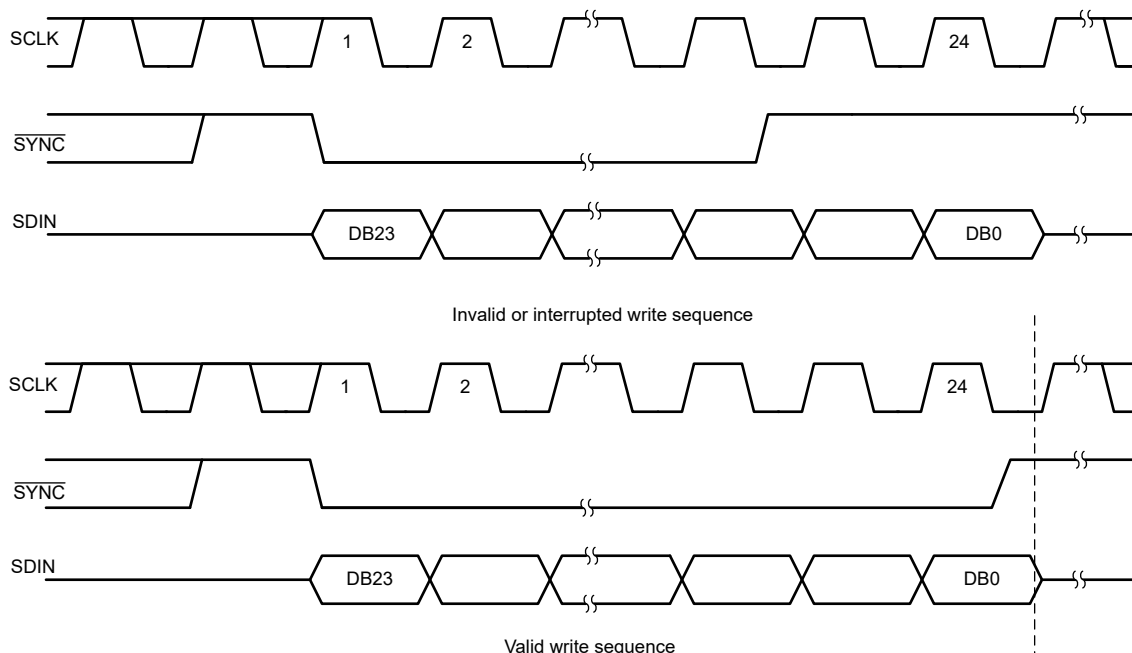

**Figure 7-3.  $\overline{\text{SYNC}}$  Interrupt**

## 7.6 Register Maps

### 7.6.1 Registers

**Table 7-2. DAC82001 Registers**

Offset	Register Description	Section
0h	No Operation	<a href="#">NOOP Register</a>
2h	Synchronization	<a href="#">SYNC Register</a>
5h	Trigger	<a href="#">TRIGGER Register</a>
8h	DAC	<a href="#">DAC Register</a>

#### 7.6.1.1 NOOP Register (offset = 0h) [reset = 0000h]

**Figure 7-4. NOOP Register**

15	14	13	12	11	10	9	8	7	6	5	4	3	2	1	0
NOOP															
W-0h															

**Table 7-3. NOOP Register Field Descriptions**

Bit	Field	Type	Reset	Description
15-0	NOOP	W	0h	No operation command

**7.6.1.2 SYNC Register (offset = 2h) [reset = 0000h]**
**Figure 7-5. SYNC Register**

15	14	13	12	11	10	9	8	7	6	5	4	3	2	1	0
RESERVED														DAC-SYNC-EN	
W-0h														W-0h	

**Table 7-4. SYNC Register Field Descriptions**

Bit	Field	Type	Reset	Description
15-1	RESERVED	W	0h	These bits are reserved.
0	DAC-SYNC-EN	W	0h	When set to 1, the DAC output is set to update in response to an LDAC trigger (synchronous mode). When cleared to 0, the DAC output is set to update immediately (asynchronous mode), default.

**7.6.1.3 TRIGGER Register (offset = 5h) [reset = 0000h]**
**Figure 7-6. TRIGGER Register**

15	14	13	12	11	10	9	8	7	6	5	4	3	2	1	0
RESERVED										LDAC	SOFT-RESET [3:0]				
W-0h										W-0h	W-0h				

**Table 7-5. TRIGGER Register Field Descriptions**

Bit	Field	Type	Reset	Description
15-5	RESERVED	W	0h	These bits are reserved.
4	LDAC	W	0h	Set this bit to 1 to synchronously load the DAC that is set to synchronous mode in the SYNC register. This bit self-resets.
3-0	SOFT-RESET [3:0]	W	0h	When set to reserved code 1010, this bit resets the device to the default state. This bit self-resets.

**7.6.1.4 DAC Register (offset = 8h) [reset = 0000h when RSTSEL is logic low, or reset = 8000h when RSTSEL is logic high]**
**Figure 7-7. DAC Register**

15	14	13	12	11	10	9	8	7	6	5	4	3	2	1	0
DAC-DATA [15:0]															
W-0000h when RSTSEL is logic low or 8000h when RSTSEL is logic high															

**Table 7-6. DAC Data Register Field Descriptions (8h)**

Bit	Field	Type	Reset	Description
15-0	DAC-DATA [15:0]	W	0000h when RSTSEL is logic low or 8000h when RSTSEL is logic high	Data are MSB aligned in straight binary format.



## 8 Application and Implementation

### Note

Information in the following applications sections is not part of the TI component specification, and TI does not warrant its accuracy or completeness. TI's customers are responsible for determining suitability of components for their purposes, as well as validating and testing their design implementation to confirm system functionality.

### 8.1 Application Information

Generating accurate, stable, programmable dc voltages is a key requirement in most precision end equipment. The DAC82001 serves a wide range of end equipment, such as battery testers, communications equipment, factory automation and control, test and measurement. The DAC82001 tiny package, high resolution, fast settling, and simple interface makes this device an excellent choice for applications such as offset and gain control, arbitrary waveform generation (AWG), closed-loop control, and bipolar analog outputs. A wide variety of operational amplifiers can be used as output buffers for the DAC82002, allowing the user to choose components that best fit their design.

### 8.2 Typical Applications

#### 8.2.1 Arbitrary Waveform Generator

Arbitrary waveform generation (AWG) circuits are common in test and measurement equipment. These circuits are used to generate ac waveforms for test applications. The key performance parameters in test and measurement circuits are total harmonic distortion and noise (THD+N), signal-to-noise ratio (SNR), and the update rate. [Figure 8-1](#) shows a basic example of an AWG circuit using the DAC82001.

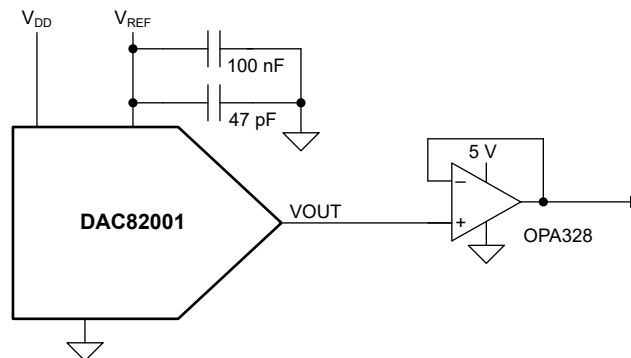

**Figure 8-1. Arbitrary Waveform Generator**

#### 8.2.1.1 Design Requirements

- DAC output range: 0 V to 2.5 V
- THD+N at 1 kHz: < -91 dB
- Update rate: 200 kHz

#### 8.2.1.2 Detailed Design Procedure

[Figure 8-1](#) shows a simplified circuit diagram of an arbitrary waveform generator. The DAC82001 specifies a THD+N of -91 dB at 1 kHz. The [OPA328](#) provides a great balance between fast settling, bandwidth, and voltage and current noise. The buffer must have a negative voltage supply rail or an output offset to make sure the DAC output is not clipped. Attach two decoupling capacitors as close as possible to the VREF pin. Use 100 nF for the first capacitor to provide very good noise performance for the system. Use 47 pF for the second capacitor to allow for a good dynamic response performance that improves any code-to-code glitch. The [REF5025](#) is a low-noise, very low-drift, precise voltage reference that generates a 2.5-V reference for this application.

### 8.2.1.3 Application Curves

Figure 8-2 shows the THD+N plot vs frequency of the buffer output using a 20-Hz to 20-kHz sine wave sweep with a DAC code range of  $0x81FF \pm 0x7E00$  to prevent voltage clipping. A 40-kHz low-pass filter is also used in the measurement tool.

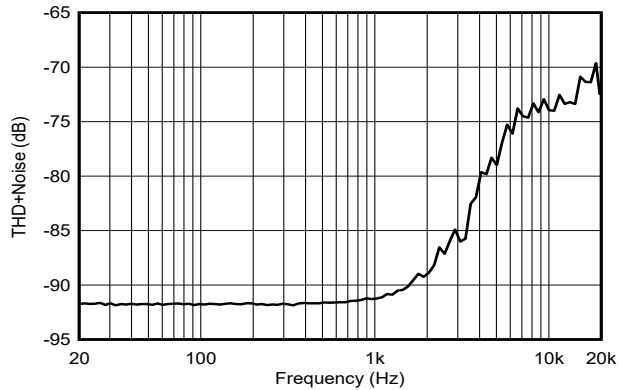

20-Hz to 20-kHz sine wave sweep with a code range of  $0x81FF \pm 0x7E00$   
40-kHz low-pass filter

**Figure 8-2. THD+N vs Frequency**

Figure 8-3 shows the FFT of the buffer output using a 1-kHz sine wave with a code range of  $0x81FF \pm 0x7E00$  to prevent voltage clipping. 32768 bins, 8 averages, and a 40-kHz low-pass filter are also used in the measurement tool.

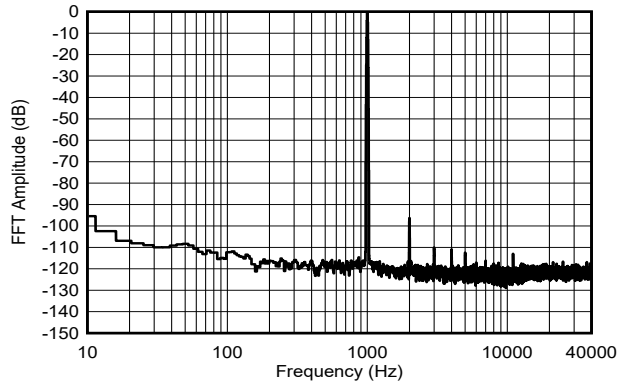

1-kHz sine wave with a code range of  $0x81FF \pm 0x7E00$   
32768 bins, 8 averages, 40-kHz low-pass filter

**Figure 8-3. FFT Amplitude vs Frequency**

## 8.2.2 Bipolar Analog Output Configuration

Programmable logic circuits (PLCs) have analog output modules that typically output  $\pm 10$  V. This bipolar analog output circuit converts the unipolar DAC output to a bipolar  $\pm 10$ -V output. The key performance parameters of these circuits are noise and slew rate. The circuit can also be used to force voltage in [semiconductor test applications](#). Figure 8-4 shows the example configuration using the DAC82001.

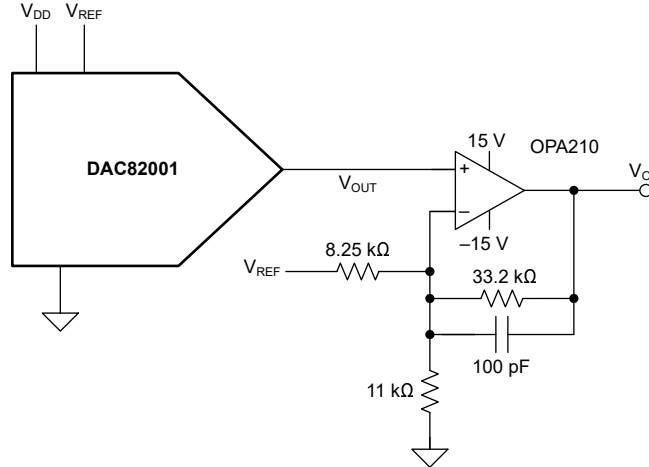

**Figure 8-4. Bipolar Analog Output Circuit**

### 8.2.2.1 Design Requirements

- DAC output range: 0 V to 2.5 V
- PLC analog output range:  $-10$  V to  $+10$  V
- Noise:  $< 3 \mu\text{V}/\sqrt{\text{Hz}}$
- Slew rate:  $> 1 \text{ V}/\mu\text{s}$

### 8.2.2.2 Detailed Design Procedure

The OPA210 output buffer provides a balance between fast settling, bandwidth, voltage and current noise, and wide voltage rails. The buffer uses  $\pm 15$ -V voltage rails to make sure there is no voltage clipping. The REF5025 is a low-noise, very low-drift, precise voltage reference and is used to generate a stable 2.5-V reference for this application. To further reduce noise, use a 100-pF capacitor between the non-inverting input pin and the output of the OPA210.

### 8.2.2.3 Application Curves

Figure 8-5 shows the noise on the buffer output vs frequency using a 100-Hz to 1-MHz frequency sweep with a grounded reference to isolate the noise in the circuit.

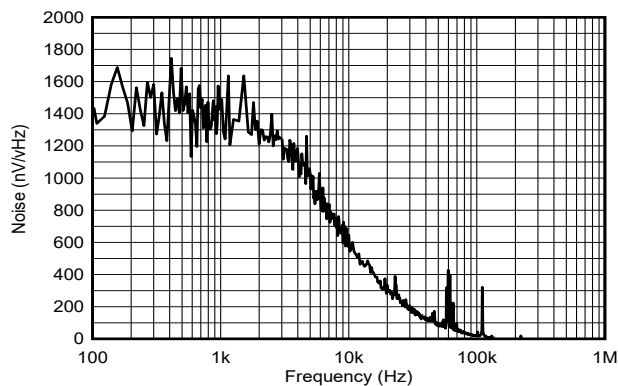

**Figure 8-5. Noise vs Frequency**

Figure 8-6 shows the output of the circuit rising from  $-10\text{ V}$  to  $+10\text{ V}$ , with the DAC starting at code  $0x0000$  and ending at code  $0xFFFF$ . The measured slew rate is  $2.5\text{ V}/\mu\text{s}$ . The REF5025 is used as a  $2.5\text{-V}$  reference.

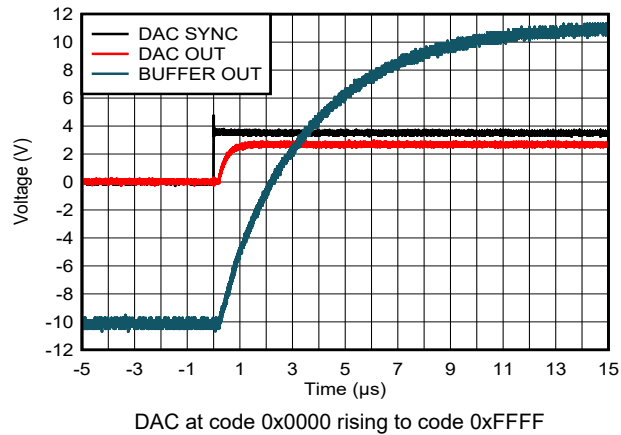

Figure 8-6. Bipolar Output Rising Slew Rate

Figure 8-7 shows the output of the circuit falling from  $+10\text{ V}$  to  $-10\text{ V}$ , with the DAC starting at code  $0xFFFF$  and ending at code  $0x0000$ . This measured slew rate is  $2.5\text{ V}/\mu\text{s}$ . The REF5025 is used as a  $2.5\text{-V}$  reference.

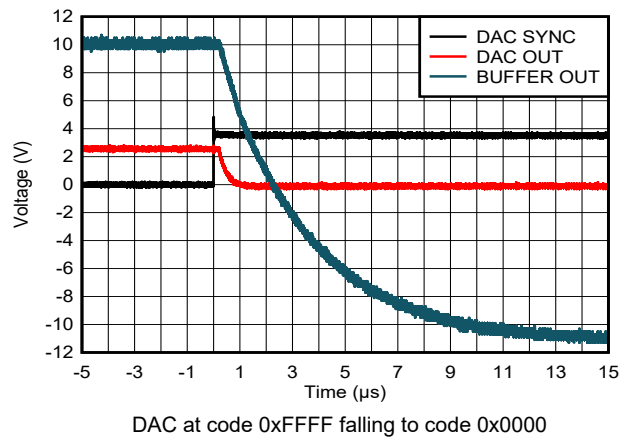

Figure 8-7. Bipolar Output Falling Slew Rate

### 8.3 Power Supply Recommendations

The DAC82001 operates within the specified  $V_{DD}$  supply range of 2.7 V to 5.5 V. The DAC82001 does not require specific supply sequencing, but  $V_{REF}$  must be less than  $V_{DD}$ , as noted in the [Absolute Maximum Ratings](#). The  $V_{DD}$  supply must be well-regulated and low-noise. Switching power supplies and DC/DC converters often have high-frequency glitches or spikes riding on the output voltage. Digital components also create similar high-frequency spikes. This noise can easily couple into the DAC output voltage through various paths between the power connections and analog output. To further minimize noise from the power supply, include a 1- $\mu$ F to 10- $\mu$ F capacitor and 0.1- $\mu$ F bypass capacitor.

### 8.4 Layout

#### 8.4.1 Layout Guidelines

A precision analog component requires careful layout. The following list provides some insight into good layout practices.

- Bypass the  $V_{DD}$  to ground with a low ESR ceramic bypass capacitor. The typical recommended bypass capacitance is 0.1- $\mu$ F to 0.22- $\mu$ F ceramic capacitor, with a X7R or NP0 dielectric.
- Bypass  $V_{REF}$  to ground with low ESR ceramic bypass capacitors.
- Place power supplies and REF bypass capacitors close to the pins to minimize inductance and optimize performance.
- The output pin,  $V_{OUT}$ , has relatively high impedance and is susceptible to high parasitic capacitance. Use short and direct traces when routing  $V_{OUT}$ .

#### 8.4.2 Layout Example

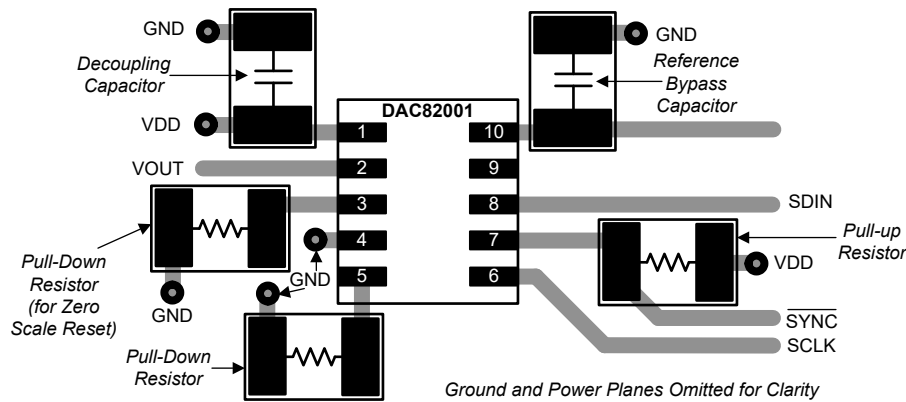

**Figure 8-8. Layout Example**

## 9 Device and Documentation Support

### 9.1 Documentation Support

#### 9.1.1 Related Documentation

For related documentation see the following: Texas Instruments, [DAC82002EVM user's guide](#)

### 9.2 Receiving Notification of Documentation Updates

To receive notification of documentation updates, navigate to the device product folder on [ti.com](#). Click on *Subscribe to updates* to register and receive a weekly digest of any product information that has changed. For change details, review the revision history included in any revised document.

### 9.3 Support Resources

[TI E2E™ support forums](#) are an engineer's go-to source for fast, verified answers and design help — straight from the experts. Search existing answers or ask your own question to get the quick design help you need.

Linked content is provided "AS IS" by the respective contributors. They do not constitute TI specifications and do not necessarily reflect TI's views; see TI's [Terms of Use](#).

### 9.4 Trademarks

TI E2E™ is a trademark of Texas Instruments.

All trademarks are the property of their respective owners.

### 9.5 Electrostatic Discharge Caution



This integrated circuit can be damaged by ESD. Texas Instruments recommends that all integrated circuits be handled with appropriate precautions. Failure to observe proper handling and installation procedures can cause damage.

ESD damage can range from subtle performance degradation to complete device failure. Precision integrated circuits may be more susceptible to damage because very small parametric changes could cause the device not to meet its published specifications.

### 9.6 Glossary

[TI Glossary](#) This glossary lists and explains terms, acronyms, and definitions.

## 10 Mechanical, Packaging, and Orderable Information

The following pages include mechanical, packaging, and orderable information. This information is the most current data available for the designated devices. This data is subject to change without notice and revision of this document. For browser-based versions of this data sheet, refer to the left-hand navigation.

**PACKAGING INFORMATION**

Orderable Device	Status (1)	Package Type	Package Drawing	Pins	Package Qty	Eco Plan (2)	Lead finish/ Ball material (6)	MSL Peak Temp (3)	Op Temp (°C)	Device Marking (4/5)	Samples
DAC82001DRXR	ACTIVE	WSO	DRX	10	3000	RoHS & Green	NIPDAUAG	Level-2-260C-1 YEAR	-40 to 85	D821	Samples

(1) The marketing status values are defined as follows:

**ACTIVE:** Product device recommended for new designs.

**LIFEBUY:** TI has announced that the device will be discontinued, and a lifetime-buy period is in effect.

**NRND:** Not recommended for new designs. Device is in production to support existing customers, but TI does not recommend using this part in a new design.

**PREVIEW:** Device has been announced but is not in production. Samples may or may not be available.

**OBSELETE:** TI has discontinued the production of the device.

(2) **RoHS:** TI defines "RoHS" to mean semiconductor products that are compliant with the current EU RoHS requirements for all 10 RoHS substances, including the requirement that RoHS substance do not exceed 0.1% by weight in homogeneous materials. Where designed to be soldered at high temperatures, "RoHS" products are suitable for use in specified lead-free processes. TI may reference these types of products as "Pb-Free".

**RoHS Exempt:** TI defines "RoHS Exempt" to mean products that contain lead but are compliant with EU RoHS pursuant to a specific EU RoHS exemption.

**Green:** TI defines "Green" to mean the content of Chlorine (Cl) and Bromine (Br) based flame retardants meet JS709B low halogen requirements of <=1000ppm threshold. Antimony trioxide based flame retardants must also meet the <=1000ppm threshold requirement.

(3) MSL, Peak Temp. - The Moisture Sensitivity Level rating according to the JEDEC industry standard classifications, and peak solder temperature.

(4) There may be additional marking, which relates to the logo, the lot trace code information, or the environmental category on the device.

(5) Multiple Device Markings will be inside parentheses. Only one Device Marking contained in parentheses and separated by a "-" will appear on a device. If a line is indented then it is a continuation of the previous line and the two combined represent the entire Device Marking for that device.

(6) Lead finish/Ball material - Orderable Devices may have multiple material finish options. Finish options are separated by a vertical ruled line. Lead finish/Ball material values may wrap to two lines if the finish value exceeds the maximum column width.

**Important Information and Disclaimer:**The information provided on this page represents TI's knowledge and belief as of the date that it is provided. TI bases its knowledge and belief on information provided by third parties, and makes no representation or warranty as to the accuracy of such information. Efforts are underway to better integrate information from third parties. TI has taken and continues to take reasonable steps to provide representative and accurate information but may not have conducted destructive testing or chemical analysis on incoming materials and chemicals. TI and TI suppliers consider certain information to be proprietary, and thus CAS numbers and other limited information may not be available for release.

In no event shall TI's liability arising out of such information exceed the total purchase price of the TI part(s) at issue in this document sold by TI to Customer on an annual basis.

**TAPE AND REEL INFORMATION**

**QUADRANT ASSIGNMENTS FOR PIN 1 ORIENTATION IN TAPE**

\*All dimensions are nominal

Device	Package Type	Package Drawing	Pins	SPQ	Reel Diameter (mm)	Reel Width W1 (mm)	A0 (mm)	B0 (mm)	K0 (mm)	P1 (mm)	W (mm)	Pin1 Quadrant
DAC82001DRXR	WS0N	DRX	10	3000	178.0	8.4	2.75	2.75	0.95	4.0	8.0	Q2



**TAPE AND REEL BOX DIMENSIONS**

\*All dimensions are nominal

Device	Package Type	Package Drawing	Pins	SPQ	Length (mm)	Width (mm)	Height (mm)
DAC82001DRXR	WSON	DRX	10	3000	205.0	200.0	33.0



# EXAMPLE BOARD LAYOUT

DRX0010A

WSON - 0.8 mm max height

PLASTIC SMALL OUTLINE - NO LEAD

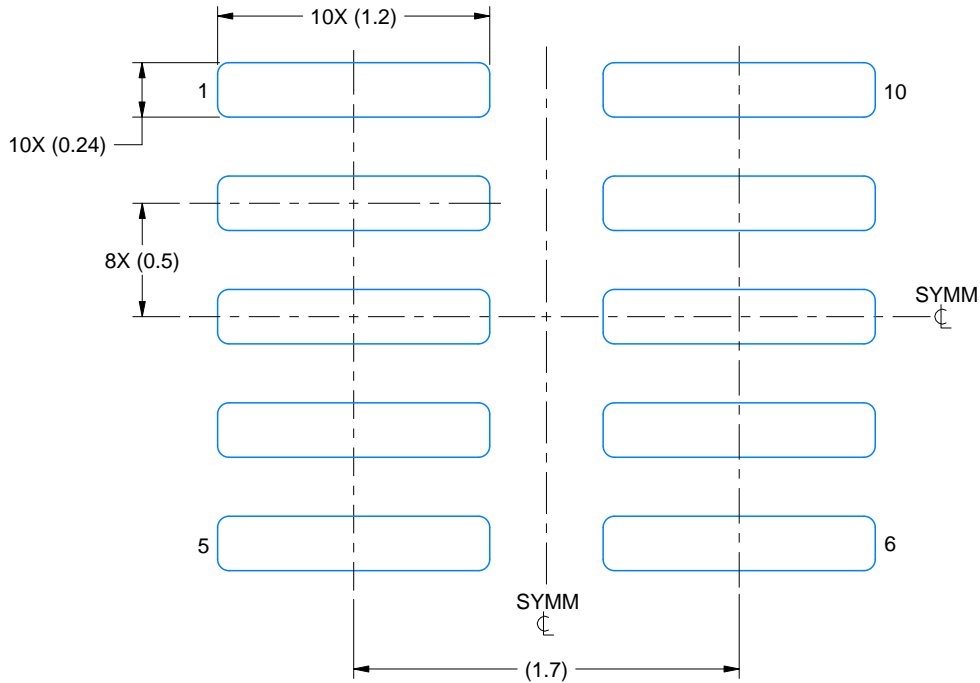

**LAND PATTERN EXAMPLE**  
EXPOSED METAL SHOWN  
SCALE:30X

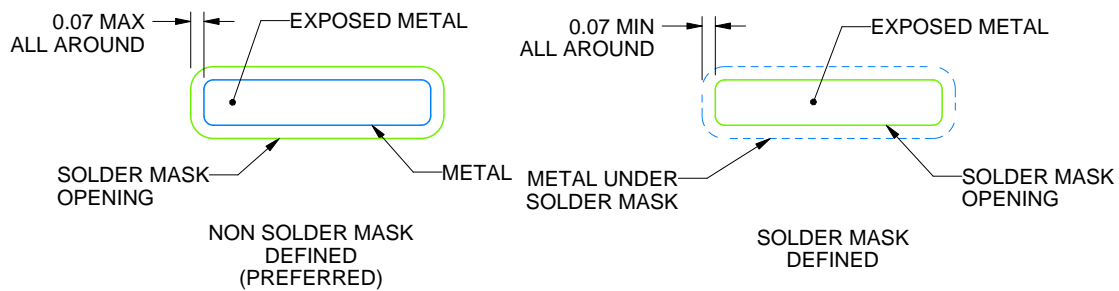

**SOLDER MASK DETAILS**

4223856/B 01/2020

NOTES: (continued)

3. For more information, see Texas Instruments literature number SLUA271 ([www.ti.com/lit/slua271](http://www.ti.com/lit/slua271)).

# EXAMPLE STENCIL DESIGN

DRX0010A

WSON - 0.8 mm max height

PLASTIC SMALL OUTLINE - NO LEAD

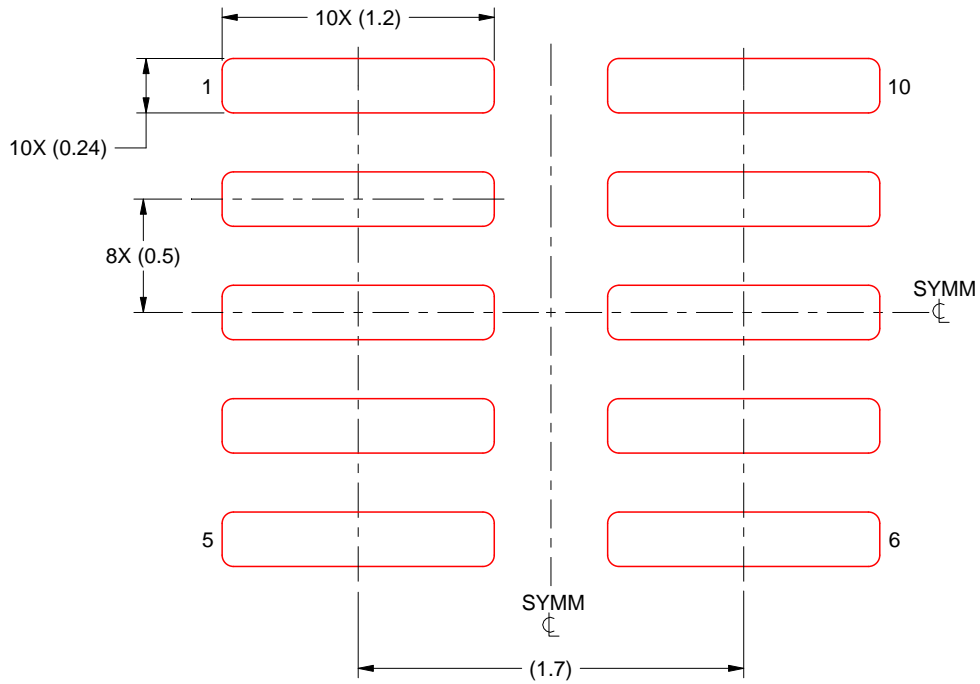

SOLDER PASTE EXAMPLE  
BASED ON 0.1 mm THICK STENCIL  
SCALE:30X

4223856/B 01/2020

NOTES: (continued)

4. Laser cutting apertures with trapezoidal walls and rounded corners may offer better paste release. IPC-7525 may have alternate design recommendations.

## IMPORTANT NOTICE AND DISCLAIMER

TI PROVIDES TECHNICAL AND RELIABILITY DATA (INCLUDING DATA SHEETS), DESIGN RESOURCES (INCLUDING REFERENCE DESIGNS), APPLICATION OR OTHER DESIGN ADVICE, WEB TOOLS, SAFETY INFORMATION, AND OTHER RESOURCES "AS IS" AND WITH ALL FAULTS, AND DISCLAIMS ALL WARRANTIES, EXPRESS AND IMPLIED, INCLUDING WITHOUT LIMITATION ANY IMPLIED WARRANTIES OF MERCHANTABILITY, FITNESS FOR A PARTICULAR PURPOSE OR NON-INFRINGEMENT OF THIRD PARTY INTELLECTUAL PROPERTY RIGHTS.

These resources are intended for skilled developers designing with TI products. You are solely responsible for (1) selecting the appropriate TI products for your application, (2) designing, validating and testing your application, and (3) ensuring your application meets applicable standards, and any other safety, security, regulatory or other requirements.

These resources are subject to change without notice. TI grants you permission to use these resources only for development of an application that uses the TI products described in the resource. Other reproduction and display of these resources is prohibited. No license is granted to any other TI intellectual property right or to any third party intellectual property right. TI disclaims responsibility for, and you will fully indemnify TI and its representatives against, any claims, damages, costs, losses, and liabilities arising out of your use of these resources.

TI's products are provided subject to [TI's Terms of Sale](#) or other applicable terms available either on [ti.com](https://www.ti.com) or provided in conjunction with such TI products. TI's provision of these resources does not expand or otherwise alter TI's applicable warranties or warranty disclaimers for TI products.

TI objects to and rejects any additional or different terms you may have proposed.

Mailing Address: Texas Instruments, Post Office Box 655303, Dallas, Texas 75265  
Copyright © 2023, Texas Instruments Incorporated