





links for paralleling with connection terminal, 3-pole for motor contactors, Size S0 3RT102. and 3RT202.

Certificates/ approvals

General Product Approval	EMC	Declaration of Conformity
  		
		Miscellaneous

Test Certificates	Shipping Approval	other
Type Test Certificates/Test Report	 	
		Confirmation

other	Railway
	Vibration and Shock

Further information

- Information- and Downloadcenter (Catalogs, Brochures,...)
<https://www.siemens.com/ic10>
- Industry Mall (Online ordering system)
<https://mall.industry.siemens.com/mall/en/en/Catalog/product?mlfb=3RT2926-4BB31>
- Cax online generator
<http://support.automation.siemens.com/WW/CAXorder/default.aspx?lang=en&mlfb=3RT2926-4BB31>
- Service&Support (Manuals, Certificates, Characteristics, FAQs,...)
<https://support.industry.siemens.com/cs/ww/en/ps/3RT2926-4BB31>
- Image database (product images, 2D dimension drawings, 3D models, device circuit diagrams, EPLAN macros, ...)
http://www.automation.siemens.com/bilddb/cax_de.aspx?mlfb=3RT2926-4BB31&lang=en

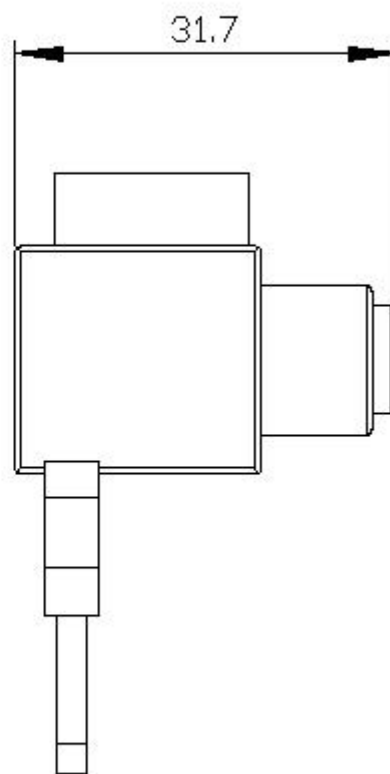
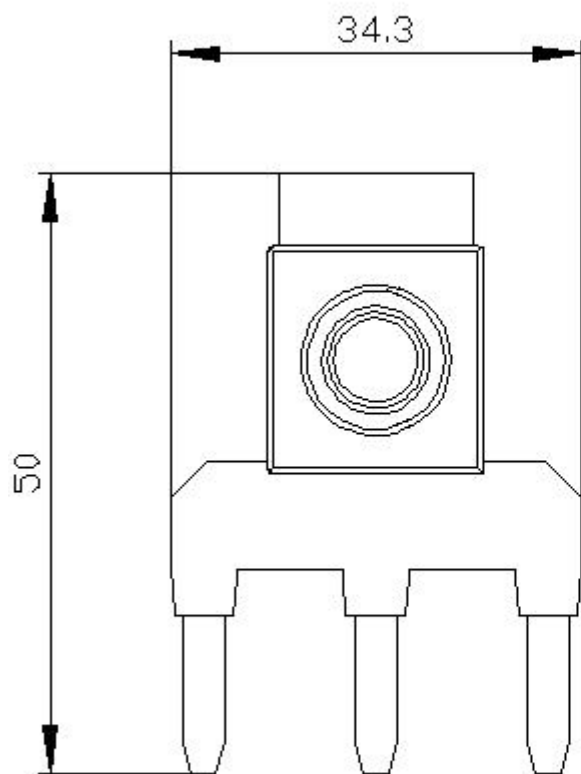

last modified:

11/4/2020 