

Intel[®] Core[™]2 Duo Processor E8000^Δ and E7000^Δ Series, Intel[®] Pentium[®] Dual-Core Processor E6000^Δ and E5000^Δ Series, and Intel[®] Celeron[®] Processor E3000^Δ Series

Thermal and Mechanical Design Guidelines

November 2010



THIS DOCUMENT AND RELATED MATERIALS AND INFORMATION ARE PROVIDED "AS IS" WITH NO WARRANTIES, EXPRESS OR IMPLIED, INCLUDING BUT NOT LIMITED TO ANY IMPLIED WARRANTY OF MERCHANTABILITY, FITNESS FOR A PARTICULAR PURPOSE, NON-INFRINGEMENT OF INTELLECTUAL PROPERTY RIGHTS, OR ANY WARRANTY OTHERWISE ARISING OUT OF ANY PROPOSAL, SPECIFICATION, OR SAMPLE. INTEL ASSUMES NO RESPONSIBILITY FOR ANY ERRORS CONTAINED IN THIS DOCUMENT AND HAS NO LIABILITIES OR OBLIGATIONS FOR ANY DAMAGES ARISING FROM OR IN CONNECTION WITH THE USE OF THIS DOCUMENT. Intel products are not intended for use in medical, life saving, life sustaining, critical control or safety systems, or in nuclear facility applications.

Intel Corporation may have patents or pending patent applications, trademarks, copyrights, or other intellectual property rights that relate to the presented subject matter. The furnishing of documents and other materials and information does not provide any license, express or implied, by 2stoppels or otherwise, to any such patents, trademarks, copyrights, or other intellectual property rights.

Intel may make changes to specifications and product descriptions at any time, without notice. Intel accepts no duty to update specifications or product descriptions with information. Designers must not rely on the absence or characteristics of any features or instructions marked "reserved" or "undefined." Intel reserves these for future definition and shall have no responsibility whatsoever for conflicts or incompatibilities arising from future changes to them.

The hardware vendor remains solely responsible for the design, sale and functionality of its product, including any liability arising from product infringement or product warranty. Intel provides this information for customer's convenience only. Use at your own risk. Intel accepts no liability for results if customer chooses at its discretion to implement these methods within its business operations. Intel makes no representations or warranties regarding the accuracy or completeness of the information provided.

Copies of documents which have an order number and are referenced in this document, or other Intel literature, may be obtained by calling 1-800-548-4725, or by visiting <http://www.intel.com>.

The Intel® Core™2 Duo processor E8000, E7000 series and Intel® Pentium® Dual-Core processor E6000, E5000 series and Intel® Celeron® processor E3000 series components may contain design defects or errors known as errata, which may cause the product to deviate from published specifications. Current characterized errata are available on request.

⁴Intel processor numbers are not a measure of performance. Processor numbers differentiate features within each processor family, not across different processor families. Over time processor numbers will increment based on changes in clock, speed, cache, FSB, or other features, and increments are not intended to represent proportional or quantitative increases in any particular feature. Current roadmap processor number progression is not necessarily representative of future roadmaps. See www.intel.com/products/processor_number for details.

Intel, Pentium, Intel Core, Celeron, Intel Inside, and the Intel logo are trademarks of Intel Corporation in the U.S. and other countries.

*Other names and brands may be claimed as the property of others.

Copyright © 2008–2010 Intel Corporation



Contents

1	Introduction	9
1.1	Document Goals and Scope	9
1.1.1	Importance of Thermal Management	9
1.1.2	Document Goals	9
1.1.3	Document Scope	10
1.2	References	11
1.3	Definition of Terms	11
2	Processor Thermal/Mechanical Information	13
2.1	Mechanical Requirements	13
2.1.1	Processor Package	13
2.1.2	Heatsink Attach	15
2.1.2.1	General Guidelines	15
2.1.2.2	Heatsink Clip Load Requirement	15
2.1.2.3	Additional Guidelines	16
2.2	Thermal Requirements	16
2.2.1	Processor Case Temperature	16
2.2.2	Thermal Profile	17
2.2.3	Thermal Solution Design Requirements	17
2.2.4	T _{CONTROL}	18
2.3	Heatsink Design Considerations	19
2.3.1	Heatsink Size	20
2.3.2	Heatsink Mass	20
2.3.3	Package IHS Flatness	21
2.3.4	Thermal Interface Material	21
2.4	System Thermal Solution Considerations	22
2.4.1	Chassis Thermal Design Capabilities	22
2.4.2	Improving Chassis Thermal Performance	22
2.4.3	Summary	23
2.5	System Integration Considerations	23
3	Thermal Metrology	25
3.1	Characterizing Cooling Performance Requirements	25
3.1.1	Example	26
3.2	Processor Thermal Solution Performance Assessment	27
3.3	Local Ambient Temperature Measurement Guidelines	27
3.4	Processor Case Temperature Measurement Guidelines	30
4	Thermal Management Logic and Thermal Monitor Feature	31
4.1	Processor Power Dissipation	31
4.2	Thermal Monitor Implementation	31
4.2.1	PROCHOT# Signal	32
4.2.2	Thermal Control Circuit	32
4.2.2.1	Thermal Monitor	32
4.2.3	Thermal Monitor 2	33
4.2.4	Operation and Configuration	34
4.2.5	On-Demand Mode	35



	4.2.6	System Considerations	35
	4.2.7	Operating System and Application Software Considerations	36
	4.2.8	THERMTRIP# Signal	36
	4.2.9	Cooling System Failure Warning	36
	4.2.10	Digital Thermal Sensor	37
	4.2.11	Platform Environmental Control Interface (PECI)	38
5		Balanced Technology Extended (BTX) Thermal/Mechanical Design Information.....	39
	5.1	Overview of the BTX Reference Design	39
	5.1.1	Target Heatsink Performance	39
	5.1.2	Acoustics	40
	5.1.3	Effective Fan Curve	41
	5.1.4	Voltage Regulator Thermal Management.....	42
	5.1.5	Altitude	43
	5.1.6	Reference Heatsink Thermal Validation	43
	5.2	Environmental Reliability Testing	43
	5.2.1	Structural Reliability Testing	43
	5.2.1.1	Random Vibration Test Procedure	43
	5.2.1.2	Shock Test Procedure	44
	5.2.2	Power Cycling	45
	5.2.3	Recommended BIOS/CPU/Memory Test Procedures	46
	5.3	Material and Recycling Requirements.....	46
	5.4	Safety Requirements	47
	5.5	Geometric Envelope for Intel® Reference BTX Thermal Module Assembly	47
	5.6	Preload and TMA Stiffness.....	48
	5.6.1	Structural Design Strategy.....	48
	5.6.2	TMA Preload verse Stiffness	48
6		ATX Thermal/Mechanical Design Information.....	51
	6.1	ATX Reference Design Requirements	51
	6.2	Validation Results for Reference Design	53
	6.2.1	Heatsink Performance	53
	6.2.2	Acoustics	54
	6.2.3	Altitude	54
	6.2.4	Heatsink Thermal Validation.....	55
	6.3	Environmental Reliability Testing	55
	6.3.1	Structural Reliability Testing	55
	6.3.1.1	Random Vibration Test Procedure	55
	6.3.1.2	Shock Test Procedure	56
	6.3.2	Power Cycling	57
	6.3.3	Recommended BIOS/CPU/Memory Test Procedures	58
	6.4	Material and Recycling Requirements.....	58
	6.5	Safety Requirements	59
	6.6	Geometric Envelope for Intel® Reference ATX Thermal Mechanical Design.....	59
	6.7	Reference Attach Mechanism	60
	6.7.1	Structural Design Strategy.....	60
	6.7.2	Mechanical Interface to the Reference Attach Mechanism	61
7		Intel® Quiet System Technology (Intel® QST)	63
	7.1	Intel® QST Algorithm.....	63
	7.1.1	Output Weighting Matrix.....	64
	7.1.2	Proportional-Integral-Derivative (PID)	64
	7.2	Board and System Implementation of Intel® QST.....	66



7.3	Intel® QST Configuration and Tuning	68
7.4	Fan Hub Thermistor and Intel® QST	68
Appendix A	LGA775 Socket Heatsink Loading	69
A.1	LGA775 Socket Heatsink Considerations	69
A.2	Metric for Heatsink Preload for ATX/uATX Designs Non-Compliant with Intel® Reference Design	69
A.3	Heatsink Preload Requirement Limitations	69
A.3.1	Motherboard Deflection Metric Definition	70
A.3.2	Board Deflection Limits	71
A.3.3	Board Deflection Metric Implementation Example	72
A.3.4	Additional Considerations	73
A.3.4.1	Motherboard Stiffening Considerations	74
A.4	Heatsink Selection Guidelines	74
Appendix B	Heatsink Clip Load Metrology	75
B.1	Overview	75
B.2	Test Preparation	75
B.2.1	Heatsink Preparation	75
B.2.2	Typical Test Equipment	78
B.3	Test Procedure Examples	78
B.3.1	Time-Zero, Room Temperature Preload Measurement	79
B.3.2	Preload Degradation under Bake Conditions	79
Appendix C	Thermal Interface Management	81
C.1	Bond Line Management	81
C.2	Interface Material Area	81
C.3	Interface Material Performance	81
Appendix D	Case Temperature Reference Metrology	83
D.1	Objective and Scope	83
D.2	Supporting Test Equipment	83
D.3	Thermal Calibration and Controls	85
D.4	IHS Groove	85
D.5	Thermocouple Attach Procedure	89
D.5.1	Thermocouple Conditioning and Preparation	89
D.5.2	Thermocouple Attachment to the IHS	90
D.5.3	Solder Process	95
D.5.4	Cleaning and Completion of Thermocouple Installation	98
D.6	Thermocouple Wire Management	102
Appendix E	Balanced Technology Extended (BTX) System Thermal Considerations	103
Appendix F	Fan Performance for Reference Design	107
Appendix G	Mechanical Drawings	109
Appendix H	Intel® Enabled Reference Solution Information	125



Figures

Figure 2-1. Package IHS Load Areas	13
Figure 2-2. Processor Case Temperature Measurement Location	17
Figure 2-3. Example Thermal Profile.....	18
Figure 3-1. Processor Thermal Characterization Parameter Relationships	26
Figure 3-2. Locations for Measuring Local Ambient Temperature, Active ATX Heatsink	29
Figure 3-3. Locations for Measuring Local Ambient Temperature, Passive Heatsink ...	29
Figure 4-1. Thermal Monitor Control.....	33
Figure 4-2. Thermal Monitor 2 Frequency and Voltage Ordering.....	34
Figure 4-3. T_{CONTROL} for Digital Thermal Sensor	37
Figure 5-1. Effective TMA Fan Curves with Reference Extrusion	42
Figure 5-2. Random Vibration PSD	44
Figure 5-3. Shock Acceleration Curve	44
Figure 5-4. Intel® Type II TMA 65W Reference Design.....	47
Figure 5-5. Upward Board Deflection During Shock	48
Figure 5-6. Minimum Required Processor Preload to Thermal Module Assembly Stiffness.....	49
Figure 5-7. Thermal Module Attach Pointes and Duct-to-SRM Interface Features.....	50
Figure 6-1. E18764-001 Reference Design – Exploded View	52
Figure 6-2. Bottom View of Copper Core Applied by TC-1996 Grease.....	52
Figure 6-3. Random Vibration PSD	56
Figure 6-4. Shock Acceleration Curve	56
Figure 6-5. Upward Board Deflection during Shock.....	60
Figure 6-6. Reference Clip/Heatsink Assembly	61
Figure 6-7. Critical Parameters for Interfacing to Reference Clip	62
Figure 6-8. Critical Core Dimension.....	62
Figure 7-1. Intel® QST Overview	64
Figure 7-2. PID Controller Fundamentals	65
Figure 7-3. Intel® QST Platform Requirements	66
Figure 7-4. Example Acoustic Fan Speed Control Implementation	67
Figure 7-5. Digital Thermal Sensor and Thermistor	68
Figure 7-6. Board Deflection Definition	71
Figure 7-7. Example—Defining Heatsink Preload Meeting Board Deflection Limit	73
Figure 7-8. Load Cell Installation in Machined Heatsink Base Pocket – Bottom View ..	76
Figure 7-9. Load Cell Installation in Machined Heatsink Base Pocket – Side View	77
Figure 7-10. Preload Test Configuration.....	77
Figure 7-11. Omega Thermocouple	84
Figure 7-12. 775-LAND LGA Package Reference Groove Drawing at 6 o'clock Exit	86
Figure 7-13. 775-LAND LGA Package Reference Groove Drawing at 3 o'clock Exit (Old Drawing)	87
Figure 7-14. IHS Groove at 6 o'clock Exit on the 775-LAND LGA Package	88
Figure 7-15. IHS Groove at 6 o'clock Exit Orientation Relative to the LGA775 Socket	88
Figure 7-16. Inspection of Insulation on Thermocouple.....	89
Figure 7-17. Bending the Tip of the Thermocouple	90
Figure 7-18. Securing Thermocouple Wires with Kapton* Tape Prior to Attach.....	90
Figure 7-19. Thermocouple Bead Placement.....	91
Figure 7-20. Position Bead on the Groove Step.....	92
Figure 7-21. Detailed Thermocouple Bead Placement	92
Figure 7-22. Third Tape Installation	93
Figure 7-23. Measuring Resistance between Thermocouple and IHS	93
Figure 7-24. Applying Flux to the Thermocouple Bead	94
Figure 7-25. Cutting Solder.....	94
Figure 7-26. Positioning Solder on IHS	95



Figure 7-27. Solder Station Setup.....	96
Figure 7-28. View Through Lens at Solder Station.....	97
Figure 7-29. Moving Solder back onto Thermocouple Bead.....	97
Figure 7-30. Removing Excess Solder.....	98
Figure 7-31. Thermocouple placed into groove.....	99
Figure 7-32. Removing Excess Solder.....	99
Figure 7-33. Filling Groove with Adhesive.....	100
Figure 7-34. Application of Accelerant.....	100
Figure 7-35. Removing Excess Adhesive from IHS.....	101
Figure 7-36. Finished Thermocouple Installation.....	101
Figure 7-37. Thermocouple Wire Management.....	102
Figure 7-38. System Airflow Illustration with System Monitor Point Area Identified.....	104
Figure 7-39. Thermal sensor Location Illustration.....	105
Figure 7-40. ATX/μATX Motherboard Keep-out Footprint Definition and Height Restrictions for Enabling Components - Sheet 1.....	110
Figure 7-41. ATX/μATX Motherboard Keep-out Footprint Definition and Height Restrictions for Enabling Components - Sheet 2.....	111
Figure 7-42. ATX/μATX Motherboard Keep-out Footprint Definition and Height Restrictions for Enabling Components - Sheet 3.....	112
Figure 7-43. BTX Thermal Module Keep Out Volumetric – Sheet 1.....	113
Figure 7-44. BTX Thermal Module Keep Out Volumetric – Sheet 2.....	114
Figure 7-45. BTX Thermal Module Keep Out Volumetric – Sheet 3.....	115
Figure 7-46. BTX Thermal Module Keep Out Volumetric – Sheet 4.....	116
Figure 7-47. BTX Thermal Module Keep Out Volumetric – Sheet 5.....	117
Figure 7-48. ATX Reference Clip – Sheet 1.....	118
Figure 7-49. ATX Reference Clip - Sheet 2.....	119
Figure 7-50. Reference Fastener - Sheet 1.....	120
Figure 7-51. Reference Fastener - Sheet 2.....	121
Figure 7-52. Reference Fastener - Sheet 3.....	122
Figure 7-53. Reference Fastener - Sheet 4.....	123
Figure 7-54. Intel® E18764-001 Reference Solution Assembly.....	124

Tables

Table 2–1. Heatsink Inlet Temperature of Intel® Reference Thermal Solutions.....	22
Table 2–2. Heatsink Inlet Temperature of Intel® Boxed Processor Thermal Solutions.....	22
Table 5–1. Balanced Technology Extended (BTX) Type II Reference TMA Performance.....	39
Table 5–2. Acoustic Targets.....	40
Table 5–3. VR Airflow Requirements.....	42
Table 5–4. Processor Preload Limits.....	49
Table 6–1. E18764-001 Reference Heatsink Performance.....	53
Table 6–2. Acoustic Results for ATX Reference Heatsink (E18764-001).....	54
Table 7–1. Board Deflection Configuration Definitions.....	70
Table 7–2. Typical Test Equipment.....	78
Table 7–3. Fan Electrical Performance Requirements.....	107
Table 7–4. Intel® Representative Contact for Licensing Information of BTX Reference Design.....	125
Table 7–5. E18764-001 Reference Thermal Solution Providers.....	125
Table 7–6. BTX Reference Thermal Solution Providers.....	126



Revision History

Revision Number	Description	Revision
001	<ul style="list-style-type: none">Initial release.	January 2008
002	<ul style="list-style-type: none">Added Intel® Core™2 Duo processor E8300 and E7200	April 2008
003	<ul style="list-style-type: none">Added Intel® Core™2 Duo processor E8600 and E7300	August 2008
004	<ul style="list-style-type: none">Added Intel® Pentium dual-core processor E5200	August 2008
005	<ul style="list-style-type: none">Added Intel® Core™2 Duo processor E7400	October 2008
006	<ul style="list-style-type: none">Added Intel® Pentium dual-core processor E5300	December 2008
007	<ul style="list-style-type: none">Added Intel® Pentium dual-core processor E5400Added Intel® Core™2 Duo processor E7500	January 2009
008	<ul style="list-style-type: none">Added Intel® Pentium dual-core processor E6300	May 2009
009	<ul style="list-style-type: none">Added Intel® Core™2 Duo processor E7600	June 2009
010	<ul style="list-style-type: none">Added Intel® Pentium dual-core processor E6500	August 2009
011	<ul style="list-style-type: none">Intel® Celeron® processor E3x00 series	August 2009
012	<ul style="list-style-type: none">Added Intel® Pentium dual-core processor E6600Intel® Celeron® processor E3400	January 2010
013	<ul style="list-style-type: none">Added Intel® Pentium dual-core processor E5500	April 2010
014	<ul style="list-style-type: none">Added Intel® Pentium dual-core processor E6700	June 2010
015	<ul style="list-style-type: none">Added Intel® Pentium dual-core processor E5700	August 2010
016	<ul style="list-style-type: none">Added Intel® Pentium dual-core processor E6800Added Intel® Celeron® processor E3500Changed the processor numbering from Intel Celeron processor E3x00 series to Intel Celeron processor E3000 series.	August 2010
017	<ul style="list-style-type: none">Added Intel® Pentium dual-core processor E5800	November 2010

§



1 Introduction

1.1 Document Goals and Scope

1.1.1 Importance of Thermal Management

The objective of thermal management is to ensure that the temperatures of all components in a system are maintained within their functional temperature range. Within this temperature range, a component is expected to meet its specified performance. Operation outside the functional temperature range can degrade system performance, cause logic errors or cause component and/or system damage. Temperatures exceeding the maximum operating limit of a component may result in irreversible changes in the operating characteristics of this component.

In a system environment, the processor temperature is a function of both system and component thermal characteristics. The system level thermal constraints consist of the local ambient air temperature and airflow over the processor as well as the physical constraints at and above the processor. The processor temperature depends in particular on the component power dissipation, the processor package thermal characteristics, and the processor thermal solution.

All of these parameters are affected by the continued push of technology to increase processor performance levels and packaging density (more transistors). As operating frequencies increase and packaging size decreases, the power density increases while the thermal solution space and airflow typically become more constrained or remains the same within the system. The result is an increased importance on system design to ensure that thermal design requirements are met for each component, including the processor, in the system.

1.1.2 Document Goals

Depending on the type of system and the chassis characteristics, new system and component designs may be required to provide adequate cooling for the processor. The goal of this document is to provide an understanding of these thermal characteristics and discuss guidelines for meeting the thermal requirements imposed on single processor systems using the Intel® Core™2 Duo processor E8000, E7000 series, Intel® Pentium® dual-core processor E6000, E5000 series, and Intel® Celeron® processor E3000 series.

The concepts given in this document are applicable to any system form factor. Specific examples used will be the Intel enabled reference solution for ATX/uATX systems. See the applicable BTX form factor reference documents to design a thermal solution for that form factor.



1.1.3 Document Scope

This design guide supports the following processors:

- Intel® Core™2 Duo processor E8000 series with 6 MB cache applies to Intel® Core™2 Duo processors E8600, E8500, E8400, E8300, E8200, and E8190
- Intel® Core™2 Duo processor E7000 series with 3 MB cache applies to Intel® Core™2 Duo processors E7600, E7500, E7400, E7300, and E7200
- Intel® Pentium® dual-core processor E5000 series with 2 MB cache applies to Intel® Pentium® dual-core processors E5800, E5700, E5500, E5400, E5300, and E5200
- Intel® Pentium® dual-core processor E6000 series with 2 MB cache applies to Intel® Pentium® dual-core processor E6800, E6700, E6600, E6500, and E6300
- Intel® Celeron® processor E3000 series with 1 MB cache applies to the Intel® Celeron® processor E3500, E3400, E3300, and E3200

In this document when a reference is made to “the processor” it is intended that this includes all the processors supported by this document. If needed for clarity, the specific processor will be listed.

In this document, when a reference is made to the “the reference design” it is intended that this means ATX reference designs (E18764-001) supported by this document. If needed for clarify, the specific reference design will be listed.

In this document, when a reference is made to “the datasheet”, the reader should refer to the *Intel® Core™2 Duo Processor E8000 and E7000 Series Datasheet*, *Intel® Pentium® Dual-Core Processor E6000 and E5000 Series Datasheet*, and *Intel® Celeron® Processor E3000 Series Datasheet*. If needed for clarity the specific processor datasheet will be referenced.

Chapter 2 of this document discusses package thermal mechanical requirements to design a thermal solution for the processor in the context of personal computer applications.

Chapter 3 discusses the thermal solution considerations and metrology recommendations to validate a processor thermal solution.

Chapter 4 addresses the benefits of the processor’s integrated thermal management logic for thermal design.

Chapter 5 gives information on the Intel reference thermal solution for the processor in BTX platform.

Chapter 6 gives information on the Intel reference thermal solution for the processor in ATX platform.

Chapter 7 discusses the implementation of acoustic fan speed control.

The physical dimensions and thermal specifications of the processor that are used in this document are for illustration only. Refer to the datasheet for the product dimensions, thermal power dissipation and maximum case temperature. In case of conflict, the data in the datasheet supersedes any data in this document.



1.2 References

Material and concepts available in the following documents may be beneficial when reading this document.

Material and concepts available in the following documents may be beneficial when reading this document.

Document	Location
Intel® Core™2 Duo Processor E8000 and E7000 Series Datasheet	www.intel.com/design/processor/datashts/318732.htm
Intel® Pentium® Dual-Core Processor E6000 and E5000 Series Datasheet	http://download.intel.com/design/processor/datashts/320467.pdf
Intel® Celeron® Processor E3000 Series Datasheet	http://download.intel.com/design/processor/datashts/322567.pdf
LGA775 Socket Mechanical Design Guide	http://developer.intel.com/design/Pentium4/guides/302666.htm
uATX SFF Design Guidance	http://www.formfactors.org/
Fan Specification for 4-wire PWM Controlled Fans	http://www.formfactors.org/
ATX Thermal Design Suggestions	http://www.formfactors.org/
microATX Thermal Design Suggestions	http://www.formfactors.org/
Balanced Technology Extended (BTX) System Design Guide	http://www.formfactors.org/
Thermally Advantaged Chassis Design Guide	http://www.intel.com/go/chassis/

1.3 Definition of Terms

Term	Description
T_A	The measured ambient temperature locally surrounding the processor. The ambient temperature should be measured just upstream of a passive heatsink or at the fan inlet for an active heatsink.
T_C	The case temperature of the processor, measured at the geometric center of the topside of the IHS.
T_E	The ambient air temperature external to a system chassis. This temperature is usually measured at the chassis air inlets.
T_S	Heatsink temperature measured on the underside of the heatsink base, at a location corresponding to T_C .
T_{C-MAX}	The maximum case temperature as specified in a component specification.
Ψ_{CA}	Case-to-ambient thermal characterization parameter (psi). A measure of thermal solution performance using total package power. This is defined as: $(T_C - T_A) / \text{Total Package Power}$. Note: Heat source must be specified for Ψ measurements.



Term	Description
Ψ_{CS}	Case-to-sink thermal characterization parameter. A measure of thermal interface material performance using total package power. This is defined as: $(T_C - T_S) / \text{Total Package Power}$. Note: Heat source must be specified for Ψ measurements.
Ψ_{Sa}	Sink-to-ambient thermal characterization parameter. A measure of heatsink thermal performance using total package power. This is defined as: $(T_S - T_A) / \text{Total Package Power}$. Note: Heat source must be specified for Ψ measurements.
TIM	Thermal Interface Material: The thermally conductive compound between the heatsink and the processor case. This material fills the air gaps and voids, and enhances the transfer of the heat from the processor case to the heatsink.
P_{MAX}	The maximum power dissipated by a semiconductor component.
TDP	Thermal Design Power: a power dissipation target based on worst-case applications. Thermal solutions should be designed to dissipate the thermal design power.
IHS	Integrated Heat Spreader: a thermally conductive lid integrated into a processor package to improve heat transfer to a thermal solution through heat spreading.
LGA775 Socket	The surface mount socket designed to accept the processors in the 775-Land LGA package.
ACPI	Advanced Configuration and Power Interface.
Bypass	Bypass is the area between a passive heatsink and any object that can act to form a duct. For this example, it can be expressed as a dimension away from the outside dimension of the fins to the nearest surface.
Thermal Monitor	A feature on the processor that attempts to keep the processor die temperature within factory specifications.
TCC	Thermal Control Circuit: Thermal Monitor uses the TCC to reduce die temperature by lowering the effective processor frequency when the die temperature has exceeded its operating limits.
DTS	Digital Thermal Sensor: Processor die sensor temperature defined as an offset from the onset of PROCHOT#.
FSC	Fan Speed Control: Thermal solution that includes a variable fan speed which is driven by a PWM signal and uses the on-die thermal diode as a reference to change the duty cycle of the PWM signal.
$T_{CONTROL}$	$T_{CONTROL}$ is the specification limit for use with the on-die thermal diode.
PWM	Pulse width modulation is a method of controlling a variable speed fan. The enabled 4-wire fans use the PWM duty cycle % from the fan speed controller to modulate the fan speed.
Health Monitor Component	Any standalone or integrated component that is capable of reading the processor temperature and providing the PWM signal to the 4-pin fan header.
BTX	Balanced Technology Extended.
TMA	Thermal Module Assembly. The heatsink, fan and duct assembly for the BTX thermal solution



2 Processor Thermal/Mechanical Information

2.1 Mechanical Requirements

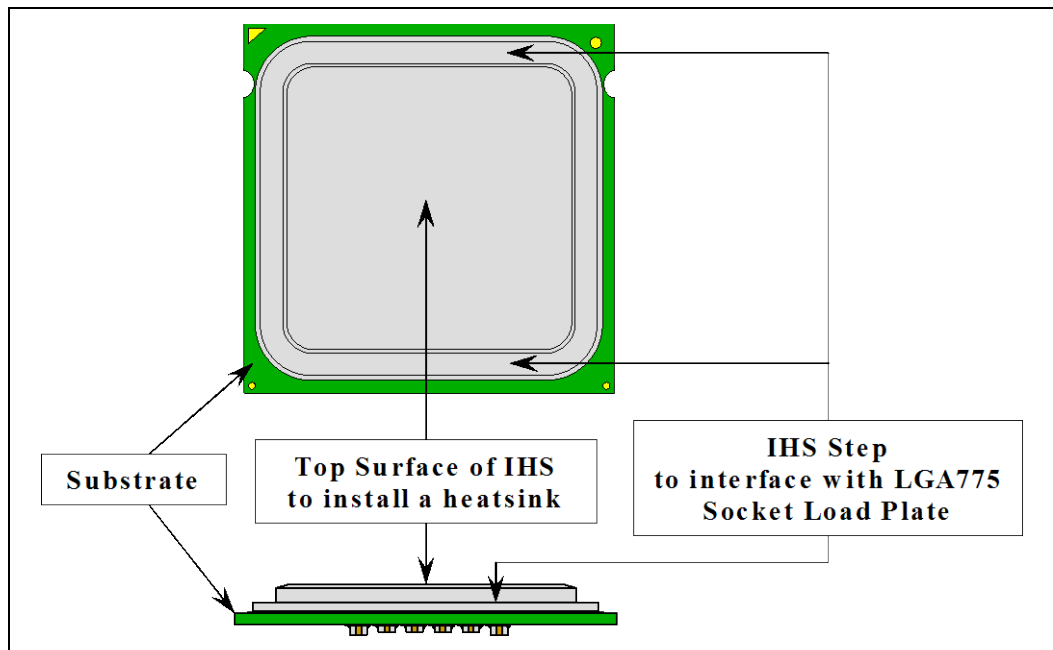
2.1.1 Processor Package

The processors covered in the document are packaged in a 775-Land LGA package that interfaces with the motherboard using a LGA775 socket. Refer to the datasheet for detailed mechanical specifications.

The processor connects to the motherboard through a land grid array (LGA) surface mount socket. The socket contains 775 contacts arrayed about a cavity in the center of the socket with solder balls for surface mounting to the motherboard. The socket is named LGA775 socket. A description of the socket can be found in the *LGA775 Socket Mechanical Design Guide*.

The package includes an integrated heat spreader (IHS) that is shown in Figure 2-1 for illustration only. Refer to the processor datasheet for further information. In case of conflict, the package dimensions in the processor datasheet supersedes dimensions provided in this document.

Figure 2-1. Package IHS Load Areas





The primary function of the IHS is to transfer the non-uniform heat distribution from the die to the top of the IHS, out of which the heat flux is more uniform and spread over a larger surface area (not the entire IHS area). This allows more efficient heat transfer out of the package to an attached cooling device. The top surface of the IHS is designed to be the interface for contacting a heatsink.

The IHS also features a step that interfaces with the LGA775 socket load plate, as described in *LGA775 Socket Mechanical Design Guide*. The load from the load plate is distributed across two sides of the package onto a step on each side of the IHS. It is then distributed by the package across all of the contacts. When correctly actuated, the top surface of the IHS is above the load plate allowing proper installation of a heatsink on the top surface of the IHS. After actuation of the socket load plate, the seating plane of the package is flush with the seating plane of the socket. Package movement during socket actuation is along the Z direction (perpendicular to substrate) only. Refer to the *LGA775 Socket Mechanical Design Guide* for further information about the LGA775 socket.

The processor package has mechanical load limits that are specified in the processor datasheet. The specified maximum static and dynamic load limits should not be exceeded during their respective stress conditions. These include heatsink installation, removal, mechanical stress testing, and standard shipping conditions.

- When a compressive static load is necessary to ensure thermal performance of the thermal interface material between the heatsink base and the IHS, it should not exceed the corresponding specification given in the processor datasheet.
- When a compressive static load is necessary to ensure mechanical performance, it should remain in the minimum/maximum range specified in the processor datasheet
- The heatsink mass can also generate additional dynamic compressive load to the package during a mechanical shock event. Amplification factors due to the impact force during shock must be taken into account in dynamic load calculations. The total combination of dynamic and static compressive load should not exceed the processor datasheet compressive dynamic load specification during a vertical shock. For example, with a 0.550 kg [1.2 lb] heatsink, an acceleration of 50G during an 11 ms trapezoidal shock with an amplification factor of 2 results in approximately a 539 N [117 lbf] dynamic load on the processor package. If a 178 N [40 lbf] static load is also applied on the heatsink for thermal performance of the thermal interface material the processor package could see up to a 717 N [156 lbf]. The calculation for the thermal solution of interest should be compared to the processor datasheet specification.

No portion of the substrate should be used as a load-bearing surface.

Finally, the processor datasheet provides package handling guidelines in terms of maximum recommended shear, tensile and torque loads for the processor IHS relative to a fixed substrate. These recommendations should be followed in particular for heatsink removal operations.



2.1.2 Heatsink Attach

2.1.2.1 General Guidelines

There are no features on the LGA775 socket to directly attach a heatsink: a mechanism must be designed to attach the heatsink directly to the motherboard. In addition to holding the heatsink in place on top of the IHS, this mechanism plays a significant role in the robustness of the system in which it is implemented, in particular:

- Ensuring thermal performance of the thermal interface material (TIM) applied between the IHS and the heatsink. TIMs based on phase change materials are very sensitive to applied pressure: the higher the pressure, the better the initial performance. TIMs such as thermal greases are not as sensitive to applied pressure. Designs should consider a possible decrease in applied pressure over time due to potential structural relaxation in retention components.
- Ensuring system electrical, thermal, and structural integrity under shock and vibration events. The mechanical requirements of the heatsink attach mechanism depend on the mass of the heatsink and the level of shock and vibration that the system must support. The overall structural design of the motherboard and the system have to be considered when designing the heatsink attach mechanism. Their design should provide a means for protecting LGA775 socket solder joints. One of the strategies for mechanical protection of the socket is to use a preload and high stiffness clip. This strategy is implemented by the reference design and described in Section 6.7.

Note: Package pull-out during mechanical shock and vibration is constrained by the LGA775 socket load plate (refer to the *LGA775 Socket Mechanical Design Guide* for further information).

2.1.2.2 Heatsink Clip Load Requirement

The attach mechanism for the heatsink developed to support the processor should create a static preload on the package between **18 lbf** and **70 lbf** throughout the life of the product for designs compliant with the reference design assumptions:

- 72 mm x 72 mm mounting hole span for ATX (refer to Figure 7-40)
- TMA preload versus stiffness for BTX within the limits shown on Figure 5-6
- And no board stiffening device (backing plate, chassis attach, and so forth).

The minimum load is required to protect against fatigue failure of socket solder joint in temperature cycling.

It is important to take into account potential load degradation from creep over time when designing the clip and fastener to the required minimum load. This means that, depending on clip stiffness, the initial preload at beginning of life of the product may be significantly higher than the minimum preload that must be met throughout the life of the product. For additional guidelines on mechanical design, in particular on designs departing from the reference design assumptions refer to Appendix A.

For clip load metrology guidelines, refer to Appendix B.



2.1.2.3 Additional Guidelines

In addition to the general guidelines given above, the heatsink attach mechanism for the processor should be designed to the following guidelines:

- Holds the heatsink in place under mechanical shock and vibration events and applies force to the heatsink base to maintain desired pressure on the thermal interface material. Note that the load applied by the heatsink attach mechanism must comply with the package specifications described in the processor datasheet. One of the key design parameters is the height of the top surface of the processor IHS above the motherboard. The IHS height from the top of board is expected to vary from 7.517 mm to 8.167 mm. This data is provided for information only, and should be derived from:
 - The height of the socket seating plane above the motherboard after reflow, given in the LGA775 Socket Mechanical Design Guide with its tolerances.
 - The height of the package, from the package seating plane to the top of the IHS, and accounting for its nominal variation and tolerances that are given in the corresponding processor datasheet.
- *Engages easily, and if possible, without the use of special tools.* In general, the heatsink is assumed to be installed after the motherboard has been installed into the chassis.
- *Minimizes contact with the motherboard surface during installation and actuation to avoid scratching the motherboard.*

2.2 Thermal Requirements

Refer to the datasheet for the processor thermal specifications. The majority of processor power is dissipated through the IHS. There are no additional components (such as BSRAMs) that generate heat on this package. The amount of power that can be dissipated as heat through the processor package substrate and into the socket is usually minimal.

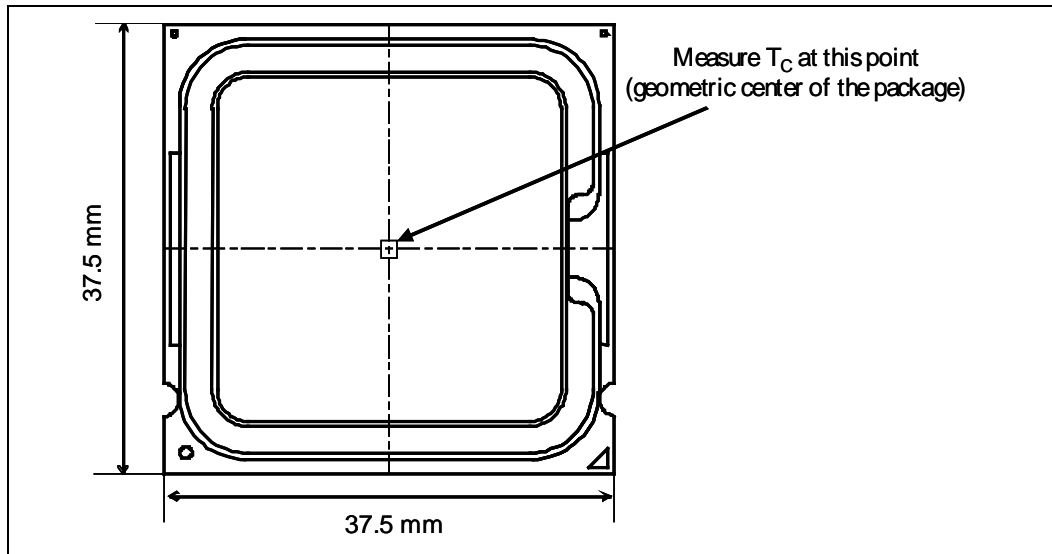
The thermal limits for the processor are the Thermal Profile and T_{CONTROL} . The Thermal Profile defines the maximum case temperature as a function of power being dissipated. T_{CONTROL} is a specification used in conjunction with the temperature reported by the digital thermal sensor and a fan speed control method. Designing to these specifications allows optimization of thermal designs for processor performance and acoustic noise reduction.

2.2.1 Processor Case Temperature

For the processor, the case temperature is defined as the temperature measured at the geometric center of the package on the surface of the IHS. For illustration, Figure 2-2 shows the measurement location for a 37.5 mm x 37.5 mm [1.474 in x 1.474 in] 775-Land LGA processor package with a 28.7 mm x 28.7 mm [1.13 in x 1.13 in] IHS top surface. Techniques for measuring the case temperature are detailed in Section 3.4.



Figure 2-2. Processor Case Temperature Measurement Location



2.2.2 Thermal Profile

The Thermal Profile defines the maximum case temperature as a function of processor power dissipation. Refer to the datasheet for the further information.

2.2.3 Thermal Solution Design Requirements

While the thermal profile provides flexibility for ATX /BTX thermal design based on its intended target thermal environment, thermal solutions that are intended to function in a multitude of systems and environments need to be designed for the worst-case thermal environment. The majority of ATX /BTX platforms are targeted to function in an environment that will have up to a 35 °C ambient temperature external to the system.

For ATX platforms, an active air-cooled design, assumed be used in ATX Chassis, with a fan installed at the top of the heatsink equivalent to the reference design (see Chapter 6) should be designed to manage the processor TDP at an inlet temperature of $35\text{ °C} + 5\text{ °C} = 40\text{ °C}$.

For BTX platforms, a front-to-back cooling design equivalent to Intel BTX TMA Type II reference design (see the Chapter 5) should be designed to manage the processor TDP at an inlet temperature of $35\text{ °C} + 0.5\text{ °C} = 35.5\text{ °C}$.

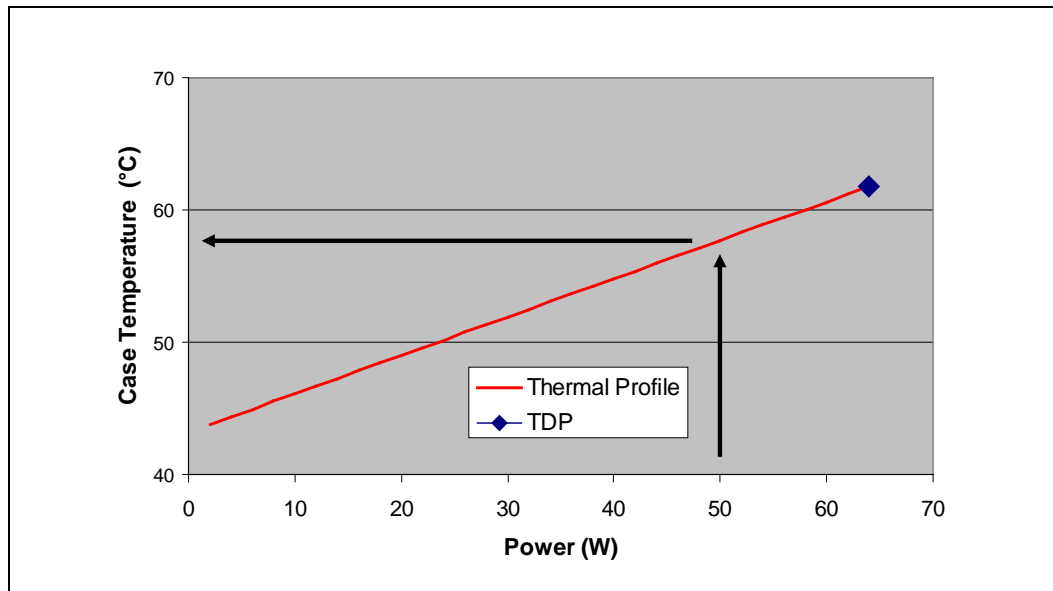
The slope of the thermal profile was established assuming a generational improvement in thermal solution performance of the Intel reference design. For an example of Intel Core™2 Duo processor E8000 series with 6 MB in ATX platform, its improvement is about 15% over the Intel reference design (E18764-001). This performance is expressed as the slope on the thermal profile and can be thought of as the thermal resistance of the heatsink attached to the processor, Ψ_{CA} (Refer to Section 3.1). The intercept on the thermal profile assumes a maximum ambient operating condition that is consistent with the available chassis solutions.



The thermal profiles for the Intel Core™2 Duo processor E8000 series with 6 MB cache, Intel Core™2 Duo processor E7000 series with 3 MB cache, and Intel Pentium dual-core processor E6000 and E5000 series with 2 MB cache, and Intel Celeron processor E3000 series with 1 MB cache are defined such that there is a single thermal solution for all of the 775_VR_CONFIG_06 processors.

To determine compliance to the thermal profile, a measurement of the actual processor power dissipation is required. The measured power is plotted on the Thermal Profile to determine the maximum case temperature. Using the example in Figure 2-3 for a processor dissipating 50 W the maximum case temperature is 58 °C. See the datasheet for the thermal profile.

Figure 2-3. Example Thermal Profile



2.2.4 T_{CONTROL}

T_{CONTROL} defines the maximum operating temperature for the digital thermal sensor when the thermal solution fan speed is being controlled by the digital thermal sensor. The T_{CONTROL} parameter defines a very specific processor operating region where fan speed can be reduced. This allows the system integrator a method to reduce the acoustic noise of the processor cooling solution, while maintaining compliance to the processor thermal specification.

Note: The T_{CONTROL} value for the processor is relative to the Thermal Control Circuit (TCC) activation set point which will be seen as 0 using the digital thermal sensor. As a result the T_{CONTROL} value will always be a negative number. See Chapter 4 for the discussion the thermal management logic and features and Chapter 7 on *Intel Quiet System Technology (Intel QST)*.

The value of T_{CONTROL} is driven by a number of factors. One of the most significant of these is the processor idle power. As a result a processor with a high (closer to 0) T_{CONTROL} will dissipate more power than a part with lower value (farther from 0, such as larger negative number) of T_{CONTROL} when running the same application.



This is achieved in part by using the Ψ_{CA} versus RPM and RPM versus Acoustics (dBA) performance curves from the Intel enabled thermal solution. A thermal solution designed to meet the thermal profile would be expected to provide similar acoustic performance of different parts with potentially different $T_{CONTROL}$ values.

The value for $T_{CONTROL}$ is calculated by the system BIOS based on values read from a factory configured processor register. The result can be used to program a fan speed control component. See the appropriate processor datasheet for further details on reading the register and calculating $T_{CONTROL}$.

See Chapter 7, *Intel® Quiet System Technology (Intel® QST)*, for details on implementing a design using $T_{CONTROL}$ and the Thermal Profile.

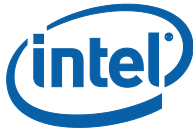
2.3 Heatsink Design Considerations

To remove the heat from the processor, three basic parameters should be considered:

- **The area of the surface on which the heat transfer takes place.** Without any enhancements, this is the surface of the processor package IHS. One method used to improve thermal performance is by attaching a heatsink to the IHS. A heatsink can increase the effective heat transfer surface area by conducting heat out of the IHS and into the surrounding air through fins attached to the heatsink base.
- **The conduction path from the heat source to the heatsink fins.** Providing a direct conduction path from the heat source to the heatsink fins and selecting materials with higher thermal conductivity typically improves heatsink performance. The length, thickness, and conductivity of the conduction path from the heat source to the fins directly impact the thermal performance of the heatsink. In particular, the quality of the contact between the package IHS and the heatsink base has a higher impact on the overall thermal solution performance as processor cooling requirements become stricter. Thermal interface material (TIM) is used to fill in the gap between the IHS and the bottom surface of the heatsink, and thereby improve the overall performance of the stack-up (IHS-TIM-Heatsink). With extremely poor heatsink interface flatness or roughness, TIM may not adequately fill the gap. The TIM thermal performance depends on its thermal conductivity as well as the pressure applied to it. Refer to Section 2.3.4 and Appendix C for further information on TIM and on bond line management between the IHS and the heatsink base.
- **The heat transfer conditions on the surface on which heat transfer takes place.** Convective heat transfer occurs between the airflow and the surface exposed to the flow. It is characterized by the local ambient temperature of the air, T_A , and the local air velocity over the surface. The higher the air velocity over the surface, and the cooler the air, the more efficient is the resulting cooling. The nature of the airflow can also enhance heat transfer using convection. Turbulent flow can provide improvement over laminar flow. In the case of a heatsink, the surface exposed to the flow includes in particular the fin faces and the heatsink base.

Active heatsinks typically incorporate a fan that helps manage the airflow through the heatsink.

Passive heatsink solutions require in-depth knowledge of the airflow in the chassis. Typically, passive heatsinks see lower air speed. These heatsinks are therefore typically larger (and heavier) than active heatsinks due to the increase in fin surface



required to meet a required performance. As the heatsink fin density (the number of fins in a given cross-section) increases, the resistance to the airflow increases: it is more likely that the air travels around the heatsink instead of through it, unless air bypass is carefully managed. Using air-ducting techniques to manage bypass area can be an effective method for controlling airflow through the heatsink.

2.3.1 Heatsink Size

The size of the heatsink is dictated by height restrictions for installation in a system and by the real estate available on the motherboard and other considerations for component height and placement in the area potentially impacted by the processor heatsink. The height of the heatsink must comply with the requirements and recommendations published for the motherboard form factor of interest. Designing a heatsink to the recommendations may preclude using it in system adhering strictly to the form factor requirements, while still in compliance with the form factor documentation.

For the ATX/microATX form factor, it is recommended to use:

- The ATX motherboard keep-out footprint definition and height restrictions for enabling components, defined for the platforms designed with the LGA775 socket in Appendix G of this design guide.
- The motherboard primary side height constraints defined in the *ATX Specification V2.1* and the *microATX Motherboard Interface Specification V1.1* found at <http://www.formfactors.org/>.

The resulting space available above the motherboard is generally not entirely available for the heatsink. The target height of the heatsink must take into account airflow considerations (for fan performance for example) as well as other design considerations (air duct, and so forth).

For BTX form factor, it is recommended to use:

- The BTX motherboard keep-out footprint definitions and height restrictions for enabling components for platforms designed with the LGA77 socket in Appendix G of this design guide.
- An overview of other BTX system considerations for thermal solutions can be obtained in the latest version of the *Balanced Technology Extended (BTX) System Design Guide* found at <http://www.formfactors.org/>.

2.3.2 Heatsink Mass

With the need to push air cooling to better performance, heatsink solutions tend to grow larger (increase in fin surface) resulting in increased mass. The insertion of highly thermally conductive materials like copper to increase heatsink thermal conduction performance results in even heavier solutions. As mentioned in Section 2.1, the heatsink mass must take into consideration the package and socket load limits, the heatsink attach mechanical capabilities, and the mechanical shock and vibration profile targets. Beyond a certain heatsink mass, the cost of developing and implementing a heatsink attach mechanism that can ensure the system integrity under the mechanical shock and vibration profile targets may become prohibitive.



The recommended maximum heatsink mass for the ATX thermal solution is 550g. This mass includes the fan and the heatsink only. The attach mechanism (clip, fasteners, and so forth) are not included.

The mass limit for BTX heatsinks that use Intel reference design structural ingredients is 900 grams. The BTX structural reference component strategy and design is reviewed in depth in the latest version of the *Balanced Technology Extended (BTX) System Design Guide*.

Note: The 550g mass limit for ATX solutions is based on the capabilities of the reference design components that retain the heatsink to the board and apply the necessary preload. Any reuse of the clip and fastener in derivative designs should not exceed 550g. ATX Designs that have a mass of greater than 550g should analyze the preload as discussed in Appendix A and retention limits of the fastener.

Note: The chipset components on the board are affected by processor heatsink mass. Exceeding these limits may require the evaluation of the chipset for shock and vibration.

2.3.3 Package IHS Flatness

The package IHS flatness for the product is specified in the datasheet and can be used as a baseline to predict heatsink performance during the design phase.

Intel recommends testing and validating heatsink performance in full mechanical enabling configuration to capture any impact of IHS flatness change due to combined socket and heatsink loading. While socket loading alone may increase the IHS warpage, the heatsink preload redistributes the load on the package and improves the resulting IHS flatness in the enabled state.

2.3.4 Thermal Interface Material

Thermal interface material application between the processor IHS and the heatsink base is generally required to improve thermal conduction from the IHS to the heatsink. Many thermal interface materials can be pre-applied to the heatsink base prior to shipment from the heatsink supplier and allow direct heatsink attach, without the need for a separate thermal interface material dispense or attach process in the final assembly factory.

All thermal interface materials should be sized and positioned on the heatsink base in a way that ensures the entire processor IHS area is covered. It is important to compensate for heatsink-to-processor attach positional alignment when selecting the proper thermal interface material size.

When pre-applied material is used, it is recommended to have a protective application tape over it. This tape must be removed prior to heatsink installation.



2.4 System Thermal Solution Considerations

2.4.1 Chassis Thermal Design Capabilities

The Intel reference thermal solutions and Intel Boxed Processor thermal solutions assume that the chassis delivers a maximum T_A at the inlet of the processor fan heatsink. The following tables show the T_A requirements for the reference solutions and Intel Boxed Processor thermal solutions.

Table 2–1. Heatsink Inlet Temperature of Intel® Reference Thermal Solutions

Topic	ATX E18764-001 ¹	BTX Type II
Heatsink Inlet Temperature	40 °C	35.5 °C

NOTE:

1. Intel reference designs (E18764-001) for ATX assume the use of the thermally advantaged chassis (refer to *Thermally Advantaged Chassis (TAC) Design Guide* for TAC thermal and mechanical requirements). The TAC 2.0 Design Guide defines a new processor cooling solution inlet temperature target of 40 °C. The existing TAC 1.1 chassis can be compatible with TAC 2.0 guidelines.

Table 2–2. Heatsink Inlet Temperature of Intel® Boxed Processor Thermal Solutions

Topic	Boxed Processor for Intel® Core™2 Duo Processor E8000, E7000 Series, Intel® Pentium® Dual-Core Processor E6000, E5000 Series, and Intel® Celeron® Processor E3000 Series
Heatsink Inlet Temperature	40 °C

NOTE:

1. Boxed Processor thermal solutions for ATX assume the use of the thermally advantaged chassis (refer to *Thermally Advantaged Chassis (TAC) Design Guide* for TAC thermal and mechanical requirements). The TAC 2.0 Design Guide defines a new processor cooling solution inlet temperature target of 40 °C. The existing TAC 1.1 chassis can be compatible with TAC 2.0 guidelines.

2.4.2 Improving Chassis Thermal Performance

The heat generated by components within the chassis must be removed to provide an adequate operating environment for both the processor and other system components. Moving air through the chassis brings in air from the external ambient environment and transports the heat generated by the processor and other system components out of the system. The number, size and relative position of fans and vents determine the chassis thermal performance, and the resulting ambient temperature around the processor. The size and type (passive or active) of the thermal solution and the amount of system airflow can be traded off against each other to meet specific system design constraints. Additional constraints are board layout, spacing, component placement, acoustic requirements, and structural considerations that limit the thermal solution size. For more information, refer to the *Performance ATX Desktop System Thermal Design Suggestions* or *Performance microATX Desktop System Thermal Design Suggestions* or *Balanced Technology Extended (BTX) System Design Guide* documents available on the <http://www.formfactors.org/> web site.



In addition to passive heatsinks, fan heatsinks and system fans are other solutions that exist for cooling integrated circuit devices. For example, ducted blowers, heat pipes, and liquid cooling are all capable of dissipating additional heat. Due to their varying attributes, each of these solutions may be appropriate for a particular system implementation.

To develop a reliable, cost-effective thermal solution, thermal characterization and simulation should be carried out at the entire system level, accounting for the thermal requirements of each component. In addition, acoustic noise constraints may limit the size, number, placement, and types of fans that can be used in a particular design.

To ease the burden on thermal solutions, the Thermal Monitor feature and associated logic have been integrated into the silicon of the processor. By taking advantage of the Thermal Monitor feature, system designers may reduce thermal solution cost by designing to TDP instead of maximum power. Thermal Monitor attempts to protect the processor during sustained workload above TDP. Implementation options and recommendations are described in Chapter 4.

2.4.3 Summary

In summary, considerations in heatsink design include:

- The local ambient temperature T_A at the heatsink, which is a function of chassis design.
- The thermal design power (TDP) of the processor, and the corresponding maximum T_C as calculated from the thermal profile. These parameters are usually combined in a single lump cooling performance parameter, Ψ_{CA} (case to air thermal characterization parameter). More information on the definition and the use of Ψ_{CA} is given Section 3.1.
- Heatsink interface to IHS surface characteristics, including flatness and roughness.
- The performance of the thermal interface material used between the heatsink and the IHS.
- The required heatsink clip static load, between 18 lbf to 70 lbf throughout the life of the product (Refer to Section 2.1.2.2 for further information).
- Surface area of the heatsink.
- Heatsink material and technology.
- Volume of airflow over the heatsink surface area.
- Development of airflow entering and within the heatsink area.
- Physical volumetric constraints placed by the system

2.5 System Integration Considerations

Manufacturing with Intel® Components using 775–Land LGA Package and LGA775 Socket documentation provides Best Known Methods for all aspects LGA775 socket based platforms and systems manufacturing. Of particular interest for package and heatsink installation and removal is the *System Assembly* module. A video covering system integration is also available. Contact your Intel field sales representative for further information.





3 Thermal Metrology

This section discusses guidelines for testing thermal solutions, including measuring processor temperatures. In all cases, the thermal engineer must measure power dissipation and temperature to validate a thermal solution. To define the performance of a thermal solution the “thermal characterization parameter”, Ψ (“psi”) will be used.

3.1 Characterizing Cooling Performance Requirements

The idea of a “thermal characterization parameter”, Ψ (“psi”), is a convenient way to characterize the performance needed for the thermal solution and to compare thermal solutions in identical situations (same heat source and local ambient conditions). The thermal characterization parameter is calculated using total package power.

Note: Heat transfer is a three-dimensional phenomenon that can rarely be accurately and easily modeled by a single resistance parameter like Ψ .

The case-to-local ambient thermal characterization parameter value (Ψ_{CA}) is used as a measure of the thermal performance of the overall thermal solution that is attached to the processor package. It is defined by the following equation, and measured in units of °C/W:

$$\Psi_{CA} = (T_C - T_A) / P_D \text{ (Equation 1)}$$

Where:

Ψ_{CA}	=	Case-to-local ambient thermal characterization parameter (°C/W)
T_C	=	Processor case temperature (°C)
T_A	=	Local ambient temperature in chassis at processor (°C)
P_D	=	Processor total power dissipation (W) (assumes all power dissipates through the IHS)

The case-to-local ambient thermal characterization parameter of the processor, Ψ_{CA} , is comprised of Ψ_{CS} , the thermal interface material thermal characterization parameter, and of Ψ_{SA} , the sink-to-local ambient thermal characterization parameter:

$$\Psi_{CA} = \Psi_{CS} + \Psi_{SA} \text{ (Equation 2)}$$

Where:

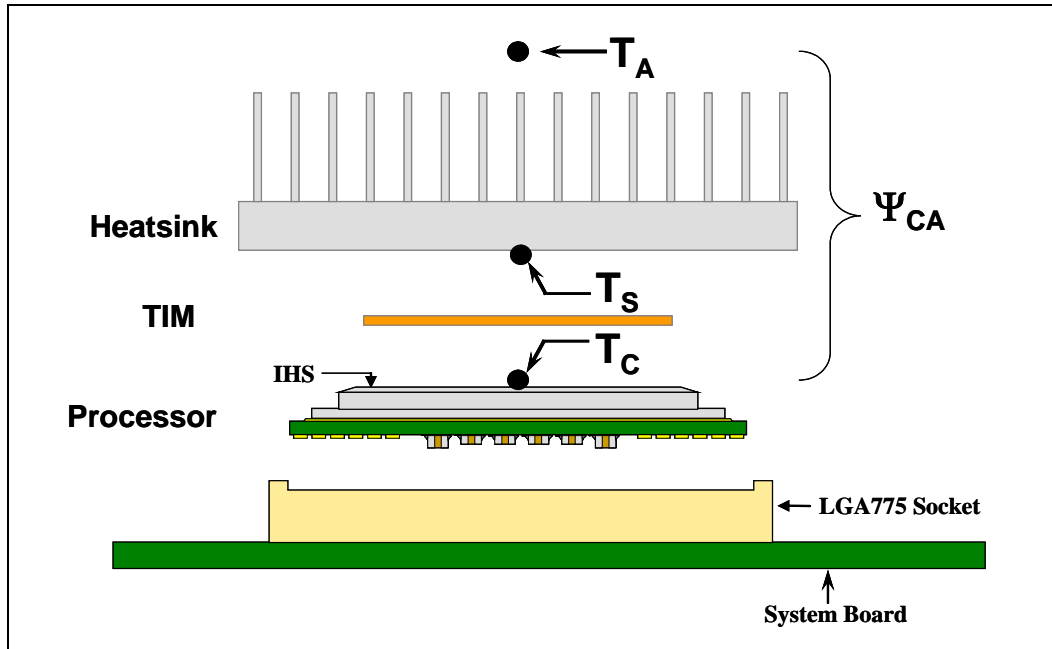
Ψ_{CS}	=	Thermal characterization parameter of the thermal interface material (°C/W)
Ψ_{SA}	=	Thermal characterization parameter from heatsink-to-local ambient (°C/W)

Ψ_{CS} is strongly dependent on the thermal conductivity and thickness of the TIM between the heatsink and IHS.

Ψ_{SA} is a measure of the thermal characterization parameter from the bottom of the heatsink to the local ambient air. Ψ_{SA} is dependent on the heatsink material, thermal conductivity, and geometry. It is also strongly dependent on the air velocity through the fins of the heatsink.

Figure 3-1 illustrates the combination of the different thermal characterization parameters.

Figure 3-1. Processor Thermal Characterization Parameter Relationships



3.1.1 Example

The cooling performance, Ψ_{CA} , is defined using the principle of thermal characterization parameter described above:

- The case temperature T_{C-MAX} and thermal design power TDP given in the processor datasheet.
- Define a target local ambient temperature at the processor, T_A .

Since the processor thermal profile applies to all processor frequencies, it is important to identify the worst case (lowest Ψ_{CA}) for a targeted chassis characterized by T_A to establish a design strategy.

The following provides an illustration of how one might determine the appropriate performance targets. The example power and temperature numbers used here are not related to any specific Intel processor thermal specifications, and are for illustrative purposes only.



Assume the TDP, as listed in the datasheet, is 100 W and the maximum case temperature from the thermal profile for 100 W is 67 °C. Assume as well that the system airflow has been designed such that the local ambient temperature is 38 °C. Then, the following could be calculated using equation 1 from above:

$$\Psi_{CA} = (T_C - T_A) / TDP = (67 - 38) / 100 = 0.29 \text{ } ^\circ\text{C/W}$$

To determine the required heatsink performance, a heatsink solution provider would need to determine Ψ_{CS} performance for the selected TIM and mechanical load configuration. If the heatsink solution were designed to work with a TIM material performing at $\Psi_{CS} \leq 0.10 \text{ } ^\circ\text{C/W}$, solving for equation 2 from above, the performance of the heatsink would be:

$$\Psi_{SA} = \Psi_{CA} - \Psi_{CS} = 0.29 - 0.10 = 0.19 \text{ } ^\circ\text{C/W}$$

3.2 Processor Thermal Solution Performance Assessment

Thermal performance of a heatsink should be assessed using a thermal test vehicle (TTV) provided by Intel. The TTV is a stable heat source that the user can make accurate power measurement, whereas processors can introduce additional factors that can impact test results. In particular, the power level from actual processors varies significantly, even when running the maximum power application provided by Intel, due to variances in the manufacturing process. The TTV provides consistent power and power density for thermal solution characterization and results can be easily translated to real processor performance. Accurate measurement of the power dissipated by an actual processor is beyond the scope of this document.

Once the thermal solution is designed and validated with the TTV, it is strongly recommended to verify functionality of the thermal solution on real processors and on fully integrated systems. The Intel maximum power application enables steady power dissipation on a processor to assist in this testing. This maximum power application is provided by Intel.

3.3 Local Ambient Temperature Measurement Guidelines

The local ambient temperature T_A is the temperature of the ambient air surrounding the processor. For a passive heatsink, T_A is defined as the heatsink approach air temperature; for an actively cooled heatsink, it is the temperature of inlet air to the active cooling fan.

It is worthwhile to determine the local ambient temperature in the chassis around the processor to understand the effect it may have on the case temperature.

T_A is best measured by averaging temperature measurements at multiple locations in the heatsink inlet airflow. This method helps reduce error and eliminate minor spatial variations in temperature. The following guidelines are meant to enable accurate determination of the localized air temperature around the processor during system thermal testing.

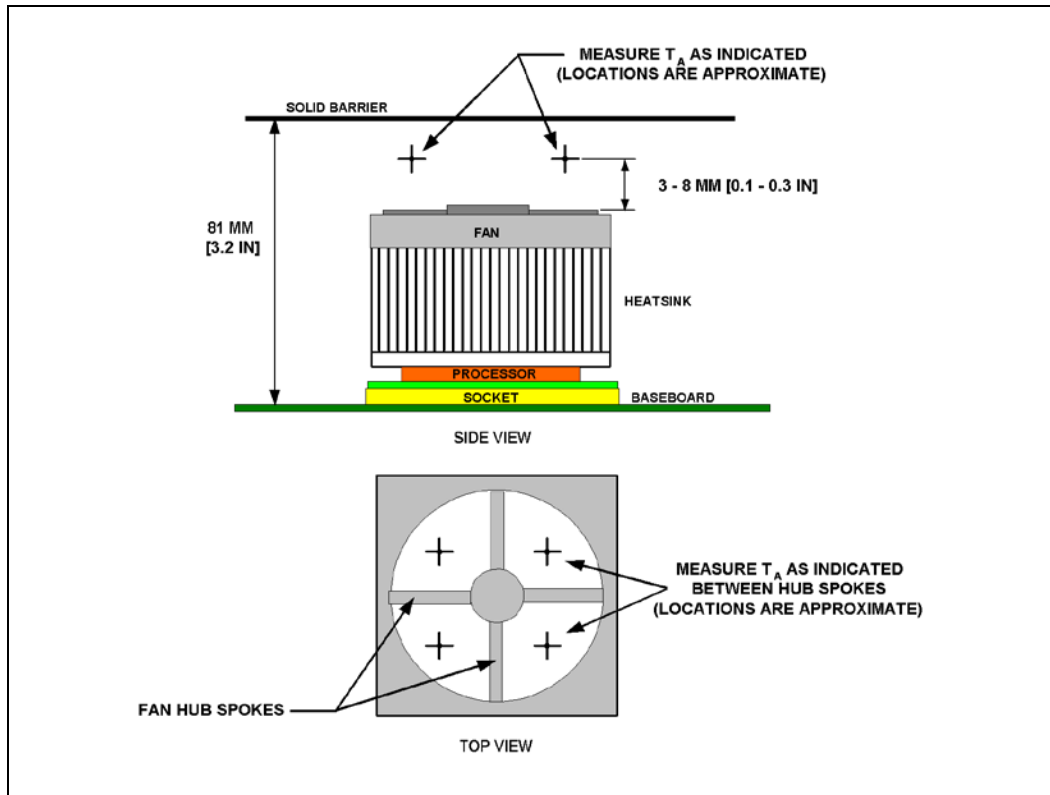


For **active heatsinks**, it is important to avoid taking measurement in the dead flow zone that usually develops above the fan hub and hub spokes. Measurements should be taken at four different locations uniformly placed at the center of the annulus formed by the fan hub and the fan housing to evaluate the uniformity of the air temperature at the fan inlet. The thermocouples should be placed approximately 3 mm to 8 mm [0.1 to 0.3 in] above the fan hub vertically and halfway between the fan hub and the fan housing horizontally as shown in the ATX heatsink in Figure 3-2 (avoiding the hub spokes). Using an open bench to characterize an active heatsink can be useful, and usually ensures more uniform temperatures at the fan inlet. However, additional tests that include a solid barrier above the test motherboard surface can help evaluate the potential impact of the chassis. This barrier is typically clear Plexiglas*, extending at least 100 mm [4 in] in all directions beyond the edge of the thermal solution. Typical distance from the motherboard to the barrier is 81 mm [3.2 in]. For even more realistic airflow, the motherboard should be populated with significant elements like memory cards, graphic card, and chipset heatsink. If a barrier is used, the thermocouple can be taped directly to the barrier with a clear tape at the horizontal location as previously described, half way between the fan hub and the fan housing. If a variable speed fan is used, it may be useful to add a thermocouple taped to the barrier above the location of the temperature sensor used by the fan to check its speed setting against air temperature. When measuring T_A in a chassis with a live motherboard, add-in cards, and other system components, it is likely that the T_A measurements will reveal a highly non-uniform temperature distribution across the inlet fan section.

For **passive heatsinks**, thermocouples should be placed approximately 13 mm to 25 mm [0.5 to 1.0 in] away from processor and heatsink as shown in Figure 3-3. The thermocouples should be placed approximately 51 mm [2.0 in] above the baseboard. This placement guideline is meant to minimize the effect of localized hot spots from baseboard components.

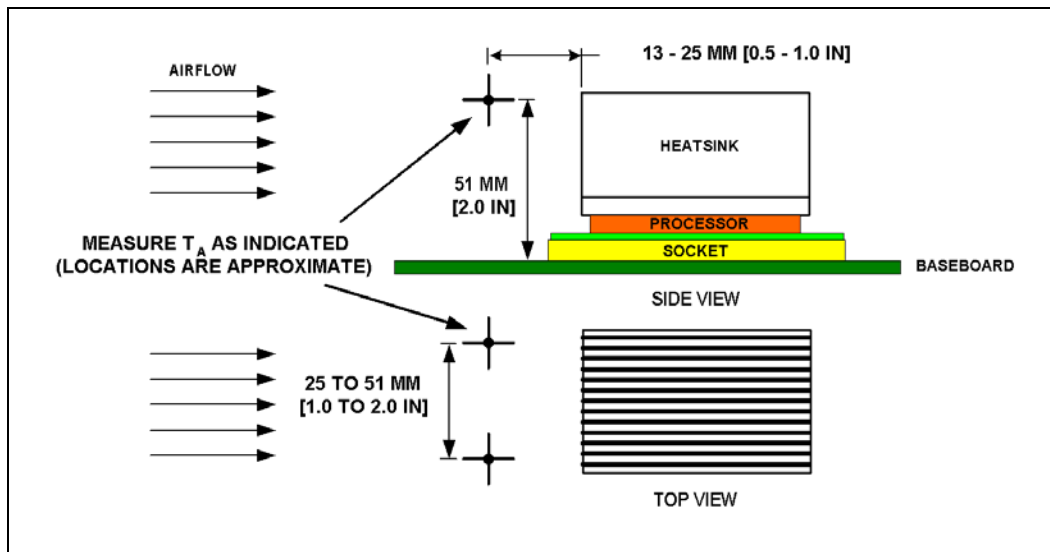
Note: Testing an active heatsink with a variable speed fan can be done in a thermal chamber to capture the worst-case thermal environment scenarios. Otherwise, when doing a bench top test at room temperature, the fan regulation prevents the heatsink from operating at its maximum capability. To characterize the heatsink capability in the worst-case environment in these conditions, it is then necessary to disable the fan regulation and power the fan directly, based on guidance from the fan supplier.

Figure 3-2. Locations for Measuring Local Ambient Temperature, Active ATX Heatsink



Note: Drawing Not to Scale

Figure 3-3. Locations for Measuring Local Ambient Temperature, Passive Heatsink



Note: Drawing Not to Scale



3.4 Processor Case Temperature Measurement Guidelines

To ensure functionality and reliability, the processor is specified for proper operation when T_C is maintained at or below the thermal profile as listed in the datasheet. The measurement location for T_C is the geometric center of the IHS. Figure 2-2 shows the location for T_C measurement.

Special care is required when measuring T_C to ensure an accurate temperature measurement. Thermocouples are often used to measure T_C . Before any temperature measurements are made, the thermocouples must be calibrated, and the complete measurement system must be routinely checked against known standards. When measuring the temperature of a surface that is at a different temperature from the surrounding local ambient air, errors could be introduced in the measurements. The measurement errors could be caused by poor thermal contact between the junction of the thermocouple and the surface of the integrated heat spreader, heat loss by radiation, convection, by conduction through thermocouple leads, or by contact between the thermocouple cement and the heatsink base.

Appendix D defines a reference procedure for attaching a thermocouple to the IHS of a 775-Land LGA processor package for T_C measurement. This procedure takes into account the specific features of the 775-Land LGA package and of the LGA775 socket for which it is intended.

§



4 Thermal Management Logic and Thermal Monitor Feature

4.1 Processor Power Dissipation

An increase in processor operating frequency not only increases system performance, but also increases the processor power dissipation. The relationship between frequency and power is generalized in the following equation:

$$P = CV^2F \text{ (where } P = \text{ power, } C = \text{ capacitance, } V = \text{ voltage, } F = \text{ frequency)}$$

From this equation, it is evident that power increases linearly with frequency and with the square of voltage. In the absence of power saving technologies, ever increasing frequencies will result in processors with power dissipations in the hundreds of watts. Fortunately, there are numerous ways to reduce the power consumption of a processor, and Intel is aggressively pursuing low power design techniques. For example, decreasing the operating voltage, reducing unnecessary transistor activity, and using more power efficient circuits can significantly reduce processor power consumption.

An on-die thermal management feature called Thermal Monitor is available on the processor. It provides a thermal management approach to support the continued increases in processor frequency and performance. By using a highly accurate on-die temperature sensing circuit and a fast acting Thermal Control Circuit (TCC), the processor can rapidly initiate thermal management control. The Thermal Monitor can reduce cooling solution cost, by allowing thermal designs to target TDP.

The processor also supports an additional power reduction capability known as Thermal Monitor 2 described in Section 4.2.3.

4.2 Thermal Monitor Implementation

The Thermal Monitor consists of the following components:

- A highly accurate on-die temperature sensing circuit
- A bi-directional signal (PROCHOT#) that indicates if the processor has exceeded its maximum temperature or can be asserted externally to activate the Thermal Control Circuit (TCC) (see Section 4.2.1 for more details on user activation of TCC using the PROCHOT# signal)
- A Thermal Control Circuit that will attempt to reduce processor temperature by rapidly reducing power consumption when the on-die temperature sensor indicates that it has exceeded the maximum operating point.
- Registers to determine the processor thermal status.



4.2.1 PROCHOT# Signal

The primary function of the PROCHOT# signal is to provide an external indication that the processor has reached the TCC activation temperature. While PROCHOT# is asserted, the TCC will be activated. Assertion of the PROCHOT# signal is independent of any register settings within the processor. It is asserted any time the processor die temperature reaches the trip point.

PROCHOT# can be configured using BIOS as an output or bi-directional signal. As an output, PROCHOT# will go active when the processor temperature of either core reaches the TCC activation temperature. As an input, assertion of PROCHOT# will activate the TCC for both cores. The TCC will remain active until the system de-asserts PROCHOT#

The temperature at which the PROCHOT# signal goes active is individually calibrated during manufacturing. Once configured, the processor temperature at which the PROCHOT# signal is asserted is not re-configurable.

One application of the Bi-directional PROCHOT# is for the thermal protection of voltage regulators (VR). System designers can implement a circuit to monitor the VR temperature and activate the TCC when the temperature limit of the VR is reached. By asserting PROCHOT# (pulled-low) which activates the TCC, the VR can cool down as a result of reduced processor power consumption. Bi-directional PROCHOT# can allow VR thermal designs to target maximum sustained current instead of maximum current. Systems should still provide proper cooling for the VR, and rely on bi-directional PROCHOT# signal only as a backup in case of system cooling failure.

Note: A thermal solution designed to meet the thermal profile specifications should rarely experience activation of the TCC as indicated by the PROCHOT# signal going active.

4.2.2 Thermal Control Circuit

The Thermal Control Circuit portion of the Thermal Monitor must be enabled for the processor to operate within specifications. The Thermal Monitor's TCC, when active, will attempt to lower the processor temperature by reducing the processor power consumption. There are two methods by which TCC can reduce processor power dissipation. These methods are referred to as Thermal Monitor 1 (TM1) and Thermal Monitor 2 (TM2).

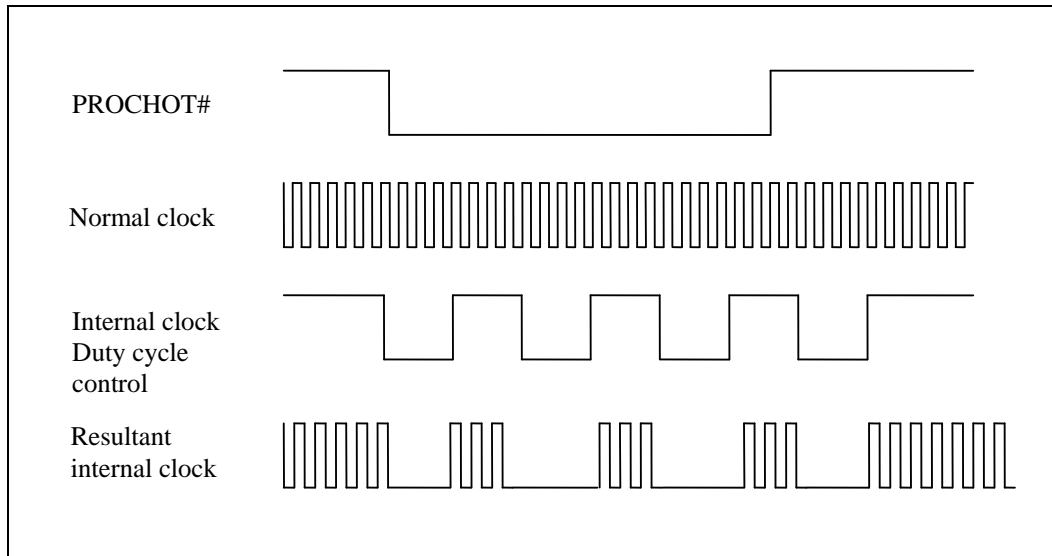
4.2.2.1 Thermal Monitor

In the original implementation of thermal monitor this is done by changing the duty cycle of the internal processor clocks, resulting in a lower effective frequency. When active, the TCC turns the processor clocks off and then back on with a predetermined duty cycle. The duty cycle is processor specific, and is fixed for a particular processor. The maximum time period the clocks are disabled is $\sim 3 \mu\text{s}$. This time period is frequency dependent and higher frequency processors will disable the internal clocks for a shorter time period. Figure 4-1 illustrates the relationship between the internal processor clocks and PROCHOT#.

Performance counter registers, status bits in model specific registers (MSRs), and the PROCHOT# output pin are available to monitor the Thermal Monitor behavior.



Figure 4-1. Thermal Monitor Control



4.2.3 Thermal Monitor 2

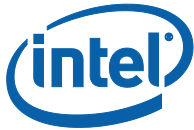
The second method of power reduction is TM2. TM2 provides an efficient means of reducing the power consumption within the processor and limiting the processor temperature.

When TM2 is enabled, and a high temperature situation is detected, the enhanced TCC will be activated. The enhanced TCC causes the processor to adjust its operating frequency (by dropping the bus-to-core multiplier to its minimum available value) and input voltage identification (VID) value. This combination of reduced frequency and VID results in a reduction in processor power consumption.

A processor enabled for TM2 includes two operating points, each consisting of a specific operating frequency and voltage. The first operating point represents the normal operating condition for the processor.

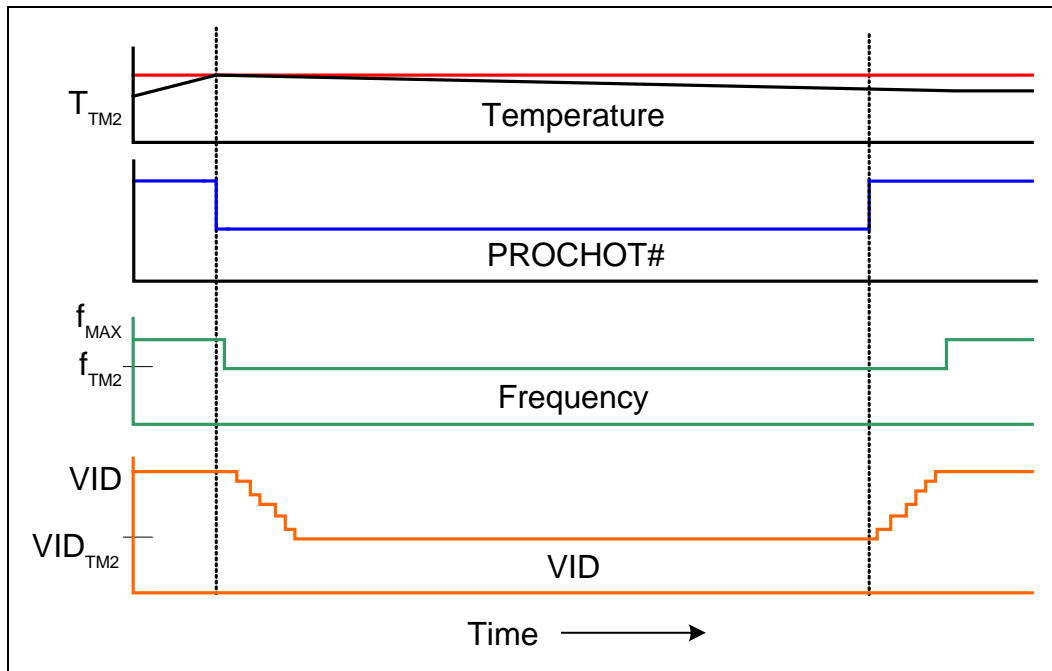
The second operating point consists of both a lower operating frequency and voltage. When the TCC is activated, the processor automatically transitions to the new frequency. This transition occurs very rapidly (on the order of 5 microseconds). During the frequency transition, the processor is unable to service any bus requests, all bus traffic is blocked. Edge-triggered interrupts will be latched and kept pending until the processor resumes operation at the new frequency.

Once the new operating frequency is engaged, the processor will transition to the new core operating voltage by issuing a new VID code to the voltage regulator. The voltage regulator must support VID transitions in order to support TM2. During the voltage change, it will be necessary to transition through multiple VID codes to reach the target operating voltage. Each step will be one VID table entry (that is, 12.5 mV steps). The processor continues to execute instructions during the voltage transition. Operation at the lower voltage reduces the power consumption of the processor, providing a temperature reduction.



Once the processor has sufficiently cooled, and a minimum activation time has expired, the operating frequency and voltage transition back to the normal system operating point. Transition of the VID code will occur first, in order to insure proper operation once the processor reaches its normal operating frequency. Refer to Figure 4-2 for an illustration of this ordering.

Figure 4-2. Thermal Monitor 2 Frequency and Voltage Ordering



Refer to the datasheet for further information on TM2.

4.2.4 Operation and Configuration

Thermal Monitor must be enabled to ensure proper processor operation.

The Thermal Control Circuit feature can be configured and monitored in a number of ways. OEMs are required to enable the Thermal Control Circuit while using various registers and outputs to monitor the processor thermal status. The Thermal Control Circuit is enabled by the BIOS setting a bit in an MSR (model specific register). Enabling the Thermal Control Circuit allows the processor to attempt to maintain a safe operating temperature without the need for special software drivers or interrupt handling routines. When the Thermal Control Circuit has been enabled, processor power consumption will be reduced after the thermal sensor detects a high temperature (that is, PROCHOT# assertion). The Thermal Control Circuit and PROCHOT# transitions to inactive once the temperature has been reduced below the thermal trip point, although a small time-based hysteresis has been included to prevent multiple PROCHOT# transitions around the trip point. External hardware can monitor PROCHOT# and generate an interrupt whenever there is a transition from active-to-inactive or inactive-to-active. PROCHOT# can also be configured to generate an internal interrupt which would initiate an OEM supplied interrupt service routine.



Regardless of the configuration selected, PROCHOT# will always indicate the thermal status of the processor.

The power reduction mechanism of thermal monitor can also be activated manually using an “on-demand” mode. Refer to Section 4.2.5 for details on this feature.

4.2.5 On-Demand Mode

For testing purposes, the thermal control circuit may also be activated by setting bits in the ACPI MSR. The MSRs may be set based on a particular system event (such as, an interrupt generated after a system event), or may be set at any time through the operating system or custom driver control thus forcing the thermal control circuit on. This is referred to as “on-demand” mode. Activating the thermal control circuit may be useful for thermal solution investigations or for performance implication studies. When using the MSRs to activate the on-demand clock modulation feature, the duty cycle is configurable in steps of 12.5%, from 12.5% to 87.5%.

For any duty cycle, the maximum time period the clocks are disabled is $\sim 3 \mu\text{s}$. This time period is frequency dependent, and decreases as frequency increases. To achieve different duty cycles, the length of time that the clocks are disabled remains constant, and the time period that the clocks are enabled is adjusted to achieve the desired ratio. For example, if the clock disable period is $3 \mu\text{s}$, and a duty cycle of $\frac{1}{4}$ (25%) is selected, the clock on time would be reduced to approximately $1 \mu\text{s}$ [on time ($1 \mu\text{s}$) \div total cycle time ($3 + 1$) $\mu\text{s} = \frac{1}{4}$ duty cycle]. Similarly, for a duty cycle of $\frac{7}{8}$ (87.5%), the clock on time would be extended to $21 \mu\text{s}$ [$21 \div (21 + 3) = \frac{7}{8}$ duty cycle].

In a high temperature situation, if the thermal control circuit and ACPI MSRs (automatic and on-demand modes) are used simultaneously, the fixed duty cycle determined by automatic mode would take precedence.

Note: On-demand mode cannot activate the power reduction mechanism of Thermal Monitor 2

4.2.6 System Considerations

Intel requires the Thermal Monitor and Thermal Control Circuit to be enabled for all processors. The thermal control circuit is intended to protect against short term thermal excursions that exceed the capability of a well designed processor thermal solution. Thermal Monitor should not be relied upon to compensate for a thermal solution that does not meet the thermal profile up to the thermal design power (TDP).

Each application program has its own unique power profile, although the profile has some variability due to loop decisions, I/O activity and interrupts. In general, compute intensive applications with a high cache hit rate dissipate more processor power than applications that are I/O intensive or have low cache hit rates.

The processor TDP is based on measurements of processor power consumption while running various high power applications. This data is used to determine those applications that are interesting from a power perspective. These applications are then evaluated in a controlled thermal environment to determine their sensitivity to activation of the thermal control circuit. This data is used to derive the TDP targets published in the processor datasheet.



A system designed to meet the thermal profile specification published in the processor datasheet greatly reduces the probability of real applications causing the thermal control circuit to activate under normal operating conditions. Systems that do not meet these specifications could be subject to more frequent activation of the thermal control circuit depending upon ambient air temperature and application power profile. Moreover, if a system is significantly under designed, there is a risk that the Thermal Monitor feature will not be capable of reducing the processor power and temperature and the processor could shutdown and signal THERMTRIP#.

For information regarding THERMTRIP#, refer to the processor datasheet and to Section 4.2.8 of this Thermal Design Guidelines.

4.2.7 Operating System and Application Software Considerations

The Thermal Monitor feature and its thermal control circuit work seamlessly with ACPI compliant operating systems. The Thermal Monitor feature is transparent to application software since the processor bus snooping, ACPI timer, and interrupts are active at all times.

4.2.8 THERMTRIP# Signal

In the event of a catastrophic cooling failure, the processor will automatically shut down when the silicon temperature has exceeded the TCC activation temperature by approximately 20 to 25 °C. At this point the system bus signal THERMTRIP# goes active and power must be removed from the processor. THERMTRIP# activation is independent of processor activity and does not generate any bus cycles. Refer to the processor datasheet for more information about THERMTRIP#.

The temperature where the THERMTRIP# signal goes active is individually calibrated during manufacturing and once configuration cannot be changed.

4.2.9 Cooling System Failure Warning

It may be useful to use the PROCHOT# signal as an indication of cooling system failure. Messages could be sent to the system administrator to warn of the cooling failure, while the thermal control circuit would allow the system to continue functioning or allow a normal system shutdown. If no thermal management action is taken, the silicon temperature may exceed the operating limits, causing THERMTRIP# to activate and shut down the processor. Regardless of the system design requirements or thermal solution ability, the Thermal Monitor feature must still be enabled to ensure proper processor operation.



4.2.10 Digital Thermal Sensor

Multiple digital thermal sensors can be implemented within the package without adding a pair of signal pins per sensor as required with the thermal diode. The digital thermal sensor is easier to place in thermally sensitive locations of the processor than the thermal diode. This is achieved due to a smaller foot print and decreased sensitivity to noise. Since the DTS is factory set on a per-part basis there is no need for the health monitor components to be updated at each processor family.

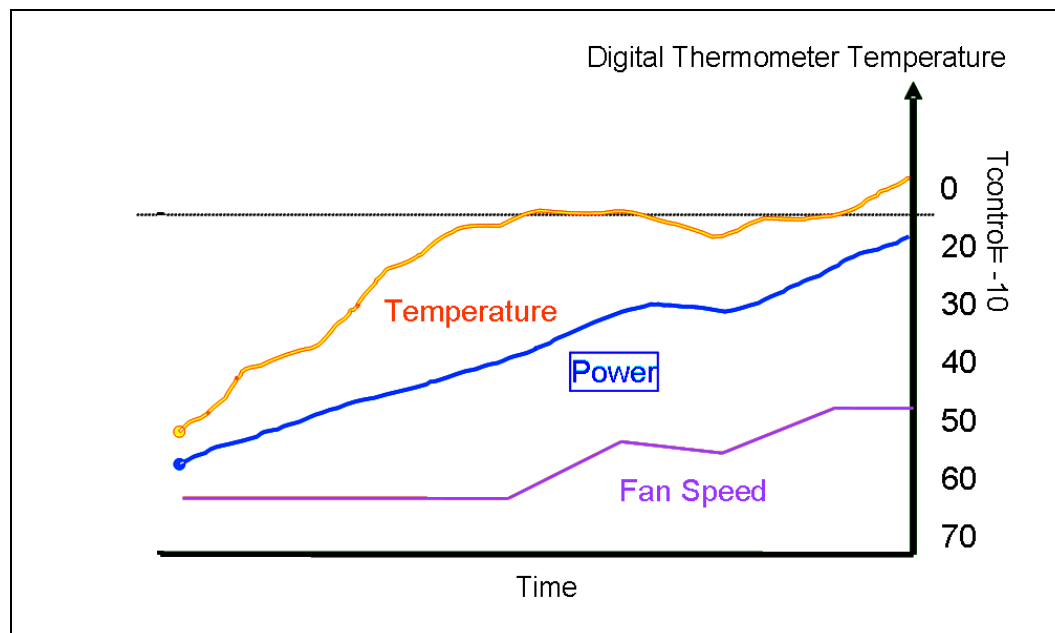
The processor uses the Digital Thermal Sensor (DTS) as the on-die sensor to use for fan speed control (FSC). The DTS is monitoring the same sensor that activates the TCC (see Section 4.2.2). Readings from the DTS are relative to the activation of the TCC. The DTS value where TCC activation occurs is 0 (zero).

A $T_{CONTROL}$ value will be provided for use with DTS. The usage model for $T_{CONTROL}$ with the DTS as below:

- If the Digital thermal sensor reading is less than $T_{CONTROL}$, the fan speed can be reduced.
- If the Digital thermal sensor reading is greater than or equal to $T_{CONTROL}$, then TC must be maintained at or below the Thermal Profile for the measured power dissipation.

The DTS $T_{CONTROL}$ value is factory configured and is written into T_{OFFSET} MSR. The BIOS can read the T_{OFFSET} MSR and provide this value to the fan speed control device.

Figure 4-3. $T_{CONTROL}$ for Digital Thermal Sensor



Note: The processor has only DTS and no thermal diode. The $T_{CONTROL}$ in the MSR is relevant only to the DTS.



4.2.11 Platform Environmental Control Interface (PECI)

The PECI interface is a proprietary single wire bus between the processor and the chipset or other health monitoring device. At this time the digital thermal sensor is the only data being transmitted. For an overview of the PECI interface, see *PECI Feature Set Overview*. For additional information on the PECI, see the datasheet.

The PECI bus is available on pin G5 of the LGA 775 socket. Intel chipsets beginning with the ICH8 have included PECI host controller. The PECI interface and the Manageability Engine are key elements to the *Intel® Quiet System Technology (Intel® QST)*, see Chapter 7 and the *Intel® Quiet System Technology Configuration and Tuning Manual*.

Intel has worked with many vendors that provide fan speed control devices to provide PECI host controllers. Consult the local representative for your preferred vendor for their product plans and availability.

§



5 Balanced Technology Extended (BTX) Thermal/Mechanical Design Information

5.1 Overview of the BTX Reference Design

The reference thermal module assembly is a Type II BTX compliant design and is compliant with the reference BTX motherboard keep-out and height recommendations defined in Section 6.6.

The solution comes as an integrated assembly. An isometric view of the assembly is provided in Figure 5-4.

5.1.1 Target Heatsink Performance

Table 5–1 provides the target heatsink performance for the processor with the BTX boundary conditions. The results will be evaluated using the test procedure described in Section 5.2.

The table also includes a T_A assumption of 35.5 °C for the Intel reference thermal solution at the processor fan heatsink inlet discussed in Section 3.3. The analysis assumes a uniform 35 °C external ambient temperature to the chassis of across the fan inlet, resulting in a temperature rise, T_R , of 0.5 °C. Meeting T_A and Ψ_{CA} targets can maximize processor performance (refer to Sections 2.2, 2.4. and Chapter 4). Minimizing T_R can lead to improved acoustics.

Table 5–1. Balanced Technology Extended (BTX) Type II Reference TMA Performance

Processor	Thermal Requirements, Ψ_{ca} (Mean + 3 σ)	T_A Assumption	Notes
Intel Core™2 Duo processor E8000 series with 6 MB cache	0.57 °C/W	35.5 °C	1,2,3
Intel Core™2 Duo processor E7000 series with 3 MB cache / Intel Pentium® dual-core processor E6000, E5000 series with 2 MB cache / Intel® Celeron® processor E3000 series with 1 MB cache	0.594 °C/W	35.5 °C	1,2,3

NOTES:

1. Performance targets (Ψ_{ca}) as measured with a live processor at TDP.
2. The difference in Ψ_{ca} between the Intel Core™2 Duo processor E8000 series with 6 MB cache, Intel Core™2 Duo processor E7000 series with 3 MB cache, Intel Pentium® dual-core processor E6000, E5000 series with 2 MB cache, and Intel® Celeron® processor E3000 series is due to a slight difference in the die size.
3. This data is pre-silicon data, and subject to change with the post silicon validate results.



5.1.2 Acoustics

To optimize acoustic emission by the fan heatsink assembly, the Type II reference design implements a variable speed fan. A variable speed fan allows higher thermal performance at higher fan inlet temperatures (T_A) and the appropriate thermal performance with improved acoustics at lower fan inlet temperatures. Using the example in Table 5–2 for the Intel Core™2 Duo processor with 4 MB cache at T_{C-MAX} of 60.1 °C the required fan speed necessary to meet thermal specifications can be controlled by the fan inlet temperature and should comply with requirements in Table 5–2.

Table 5–2. Acoustic Targets

Fan Speed RPM	Thermistor Set Point	Acoustic	Thermal Requirements, Ψ_{ca}	Notes
~ 5300	High $T_A \geq 35$ °C	≤ 6.4 BA	0.38° C/W	Case 1: Thermal Design Power Maximum fan speed 100% PWM duty cycle
~ 2500	Low $T_A = 23$ °C	No Target Defined	0.56° C/W	Case 2 Thermal Design Power System (PSU, HDD, TMA) Fan speed limited by the fan hub thermistor
~ 1400	Low $T_A = 23$ °C	≤ 3.4 BA	~0.87° C/W	Case 3 50% Thermal Design Power TMA Only
~ 1400	Low $T_A = 23$ °C	≤ 4.0 BA	~0.87° C/W	Case 3 50% Thermal Design Power System (PSU, HDD, TMA)

NOTES:

1. Acoustic performance is defined in terms of measured sound power (LwA) as defined in ISO 9296 standard, and measured according to ISO 7779.
2. Acoustic testing will be for the TMA only when installed in a BTX S2 chassis for Case 1 and 3.
3. Acoustics testing for Case 2 will be system level in the same a BTX S2 reference chassis and commercially available power supply. Acoustic data for Case 2 will be provided in the validation report but this condition is not a target for the design. The acoustic model is predicting that the power supply fan will be the acoustic limiter.
4. The fan speeds (RPM) are estimates for one of the two reference fans and will be adjusted to meet thermal performance targets then acoustic target during validation. The designer should identify the fan speed required to meet the effective fan curve shown in Section 5.1.3.

While the fan hub thermistor helps optimize acoustics at high processor workloads by adapting the maximum fan speed to support the processor thermal profile, additional acoustic improvements can be achieved at lower processor workload by using the $T_{CONTROL}$ specifications described in Section 2.2.4. Intel's recommendation is to use the fan with 4 Wire PWM Controlled to implement fan speed control capability based the digital thermal sensor. Refer to Chapter 7 for further details.

Note: Appendix F gives detailed fan performance for the Intel reference thermal solutions with 4 Wire PWM Controlled fan.



5.1.3 Effective Fan Curve

The TMA must fulfill the processor cooling requirements shown in Table 5–1 when it is installed in a functional BTX system. When installed in a system, the TMA must operate against the backpressure created by the chassis impedance (due to vents, bezel, peripherals, and so forth) and will operate at lower net airflow than if it were tested outside of the system on a bench top or open air environment. Therefore, an allowance must be made to accommodate or predict the reduction in Thermal Module performance due to the reduction in heatsink airflow from chassis impedance. For this reason, it is required that the Thermal Module satisfy the prescribed Ψ_{CA} requirements when operating against an impedance that is characteristic for BTX platforms.

Because of the coupling between TMA thermal performance and system impedance, the designer should understand the TMA effective fan curve. This effective fan curve represents the performance of the fan component AND the impedance of the stator, heatsink, duct, and flow partitioning devices. The BTX system integrator can evaluate a TMA based on the effective fan curve of the assembly and the airflow impedance of their target system.

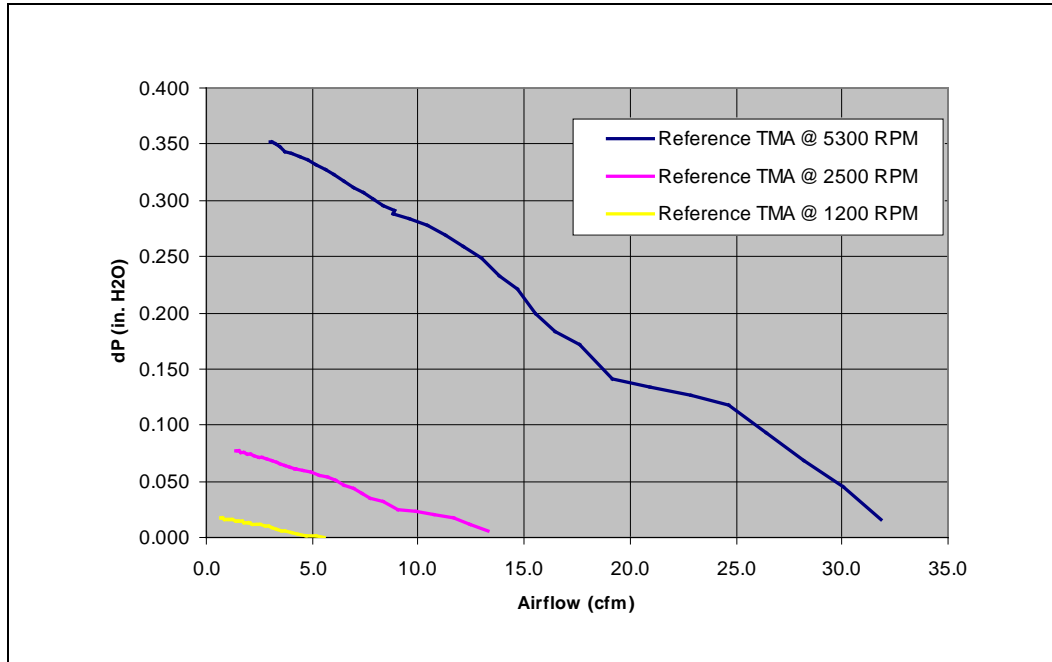
Note: It is likely that at some operating points the fans speed will be driven by the system airflow requirements and not the processor thermal limits.

Figure 5-1 shows the effective fan curve for the reference design TMA. These curves are based on analysis. The boundary conditions used are the S2 6.9L reference chassis, the reference TMA with the flow partitioning device, extrusion and an AVC Type II fan geometry.

When selecting a fan for use in the TMA care should be taken that similar effective fan curves can be achieved. Final verification requires the overlay of the Type II MASI curve to ensure thermal compliance.



Figure 5-1. Effective TMA Fan Curves with Reference Extrusion



5.1.4 Voltage Regulator Thermal Management

The BTX TMA is integral to the cooling of the processor voltage regulator (VR). The reference design TMA will include a flow partitioning device to ensure an appropriate airflow balance between the TMA and the VR. In validation the need for this component will be evaluated.

The BTX thermal management strategy relies on the Thermal Module to provide effective cooling for the voltage regulator (VR) chipset and system memory components on the motherboard. The Thermal Module is required to have features that allow for airflow to bypass the heatsink and flow over the VR region on both the primary and secondary sides of the board. The following requirements apply to VR cooling.

Table 5–3. VR Airflow Requirements

Item	Target
Minimum VR bypass airflow for 775_VR_CONFIG_06 processors	2.4 CFM

NOTES:

1. This is the recommended airflow rate that should be delivered to the VR when the VR power is at a maximum in order to support the 775_VR_CONFIG_06 processors at TDP power dissipation and the chassis external environment temperature is at 35 °C. Less airflow is necessary when the VR power is not at a maximum or if the external ambient temperature is less than 35 °C.
2. This recommended airflow rate is based on the requirements for the Intel 965 Express Chipset Family.



5.1.5 Altitude

The reference TMA will be evaluated at sea level. However, many companies design products that must function reliably at high altitude, typically 1,500 m [5,000 ft] or more. Air-cooled temperature calculations and measurements at sea level must be adjusted to take into account altitude effects like variation in air density and overall heat capacity. This often leads to some degradation in thermal solution performance compared to what is obtained at sea level, with lower fan performance and higher surface temperatures. The system designer needs to account for altitude effects in the overall system thermal design to make sure that the T_c requirement for the processor is met at the targeted altitude.

5.1.6 Reference Heatsink Thermal Validation

The Intel reference heatsink will be validated within the specific boundary conditions based on the methodology described Section 5.2 , and using a thermal test vehicle.

Testing is done in a BTX chassis at ambient lab temperature. The test results, for a number of samples, will be reported in terms of a worst-case mean + 3σ value for thermal characterization parameter using real processors (based on the thermal test vehicle correction factors).

5.2 Environmental Reliability Testing

5.2.1 Structural Reliability Testing

Structural reliability tests consist of unpackaged, system -level vibration and shock tests of a given thermal solution in the assembled state. The thermal solution should meet the specified thermal performance targets after these tests are conducted; however, the test conditions outlined here may differ from your own system requirements.

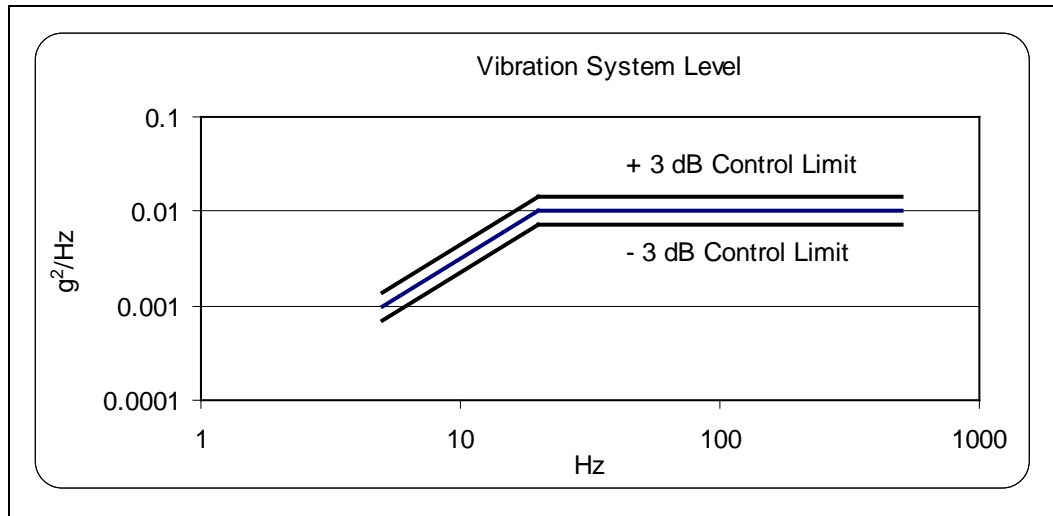
5.2.1.1 Random Vibration Test Procedure

Recommended performance requirement for a system:

- Duration: 10 min/axis, 3 axes
- Frequency Range: 5 Hz to 500 Hz
5 Hz @ .001 g²/Hz to 20 Hz @ 0.01 g²/Hz (slope up)
20 Hz to 500 Hz @ 0.01 g²/Hz (flat)
- Power Spectral Density (PSD) Profile: 2.2 G RMS



Figure 5-2. Random Vibration PSD

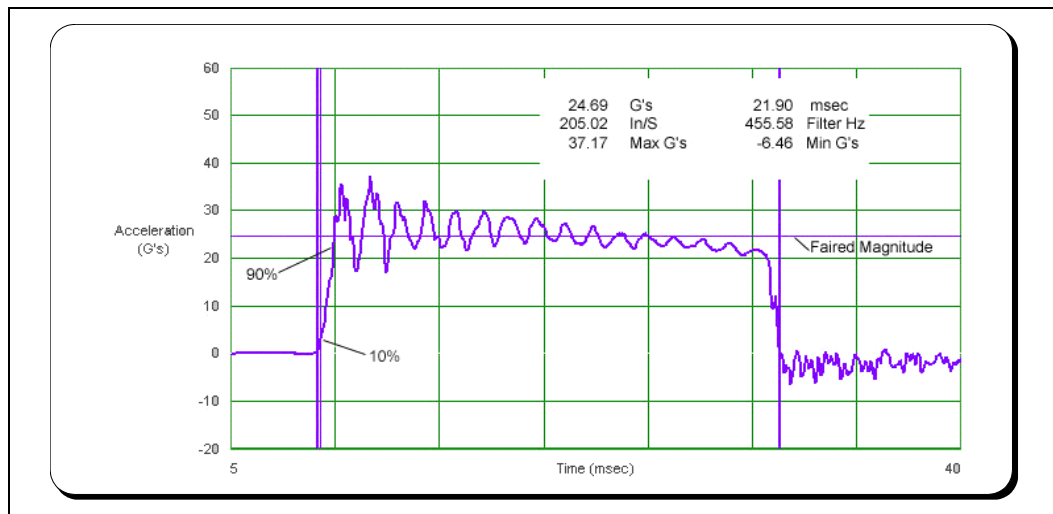


5.2.1.2 Shock Test Procedure

Recommended performance requirement for a system:

- Quantity: 2 drops for + and - directions in each of 3 perpendicular axes (that is, total 12 drops).
- Profile: 25 G trapezoidal waveform
225 in/sec minimum velocity change. (systems > 20 lbm)
250 in/sec minimum velocity change. (systems < 20 lbm)
- Setup: Mount sample system on tester.

Figure 5-3. Shock Acceleration Curve





5.2.1.2.1 Recommended Test Sequence

Each test sequence should start with components (that is, motherboard, heatsink assembly, and so forth) that have never been previously submitted to any reliability testing.

The test sequence should always start with a visual inspection after assembly, and BIOS/CPU/Memory test (refer to Section 6.3.3).

Prior to the mechanical shock & vibration test, the units under test should be preconditioned for 72 hours at 45° C. The purpose is to account for load relaxation during burn-in stage.

The stress test should be followed by a visual inspection and then BIOS/CPU/Memory test.

5.2.1.2.2 Post-Test Pass Criteria

The post-test pass criteria are:

1. No significant physical damage to the heatsink attach mechanism (including such items as clip and motherboard fasteners).
2. Heatsink must remain attached to the motherboard.
3. Heatsink remains seated and its bottom remains mated flatly against IHS surface. No visible gap between the heatsink base and processor IHS. No visible tilt of the heatsink with respect to its attach mechanism.
4. No signs of physical damage on motherboard surface due to impact of heatsink or heatsink attach mechanism.
5. No visible physical damage to the processor package.
6. Successful BIOS/Processor/memory test of post-test samples.
7. Thermal compliance testing to demonstrate that the case temperature specification can be met.

5.2.2 Power Cycling

Thermal performance degradation due to TIM degradation is evaluated using power cycling testing. The test is defined by 7500 cycles for the case temperature from room temperature (~23° C) to the maximum case temperature defined by the thermal profile at TDP. A Thermal Test Vehicle is used for this test.



5.2.3 Recommended BIOS/CPU/Memory Test Procedures

This test is to ensure proper operation of the product before and after environmental stresses, with the thermal mechanical enabling components assembled. The test shall be conducted on a fully operational motherboard that has not been exposed to any battery of tests prior to the test being considered.

Testing setup should include the following components, properly assembled and/or connected:

- Appropriate system motherboard
- Processor
- All enabling components, including socket and thermal solution parts
- Power supply
- Disk drive
- Video card
- DIMM
- Keyboard
- Monitor

The pass criterion is that the system under test shall successfully complete the checking of BIOS, basic processor functions and memory, without any errors.

5.3 Material and Recycling Requirements

Material shall be resistant to fungal growth. Examples of non-resistant materials include cellulose materials, animal and vegetable based adhesives, grease, oils, and many hydrocarbons. Synthetic materials such as PVC formulations, certain polyurethane compositions (such as, polyester and some polyethers), plastics that contain organic fillers of laminating materials, paints, and varnishes also are susceptible to fungal growth. If materials are not fungal growth resistant, then MIL-STD-810E, Method 508.4 must be performed to determine material performance.

Material used shall not have deformation or degradation in a temperature life test.

Any plastic component exceeding 25 grams must be recyclable per the European Blue Angel recycling standards.



5.4 Safety Requirements

Heatsink and attachment assemblies shall be consistent with the manufacture of units that meet the safety standards:

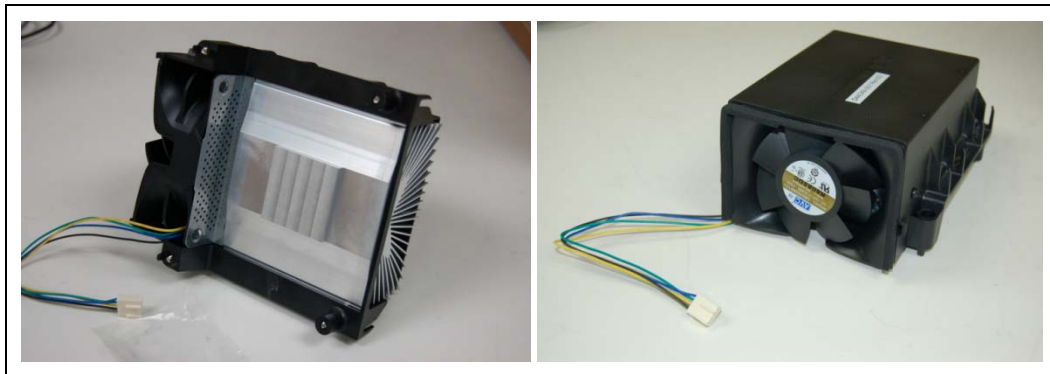
- UL Recognition-approved for flammability at the system level. All mechanical and thermal enabling components must be a minimum UL94V-2 approved.
- CSA Certification. All mechanical and thermal enabling components must have CSA certification.
- All components (in particular the heatsink fins) must meet the test requirements of UL1439 for sharp edges.
- If the International Accessibility Probe specified in IEC 950 can access the moving parts of the fan, consider adding safety feature so that there is no risk of personal injury.

5.5 Geometric Envelope for Intel® Reference BTX Thermal Module Assembly

Figure 7-43 through Figure 7-47 in Appendix G provides the motherboard keep-out information for the BTX thermal mechanical solutions. Additional information on BTX design considerations can be found in the *Balanced Technology Extended (BTX) System Design Guide* available at <http://www.formfactors.org>.

The maximum height of the TMA above the motherboard is 60.60 mm [2.386 inches], for compliance with the motherboard primary side height constraints defined in the *BTX Interface Specification* for Zone A, found at <http://www.formfactors.org>.

Figure 5-4. Intel® Type II TMA 65W Reference Design



Development vendor information for the Intel Type II TMA Reference Solution is provided in Appendix H.



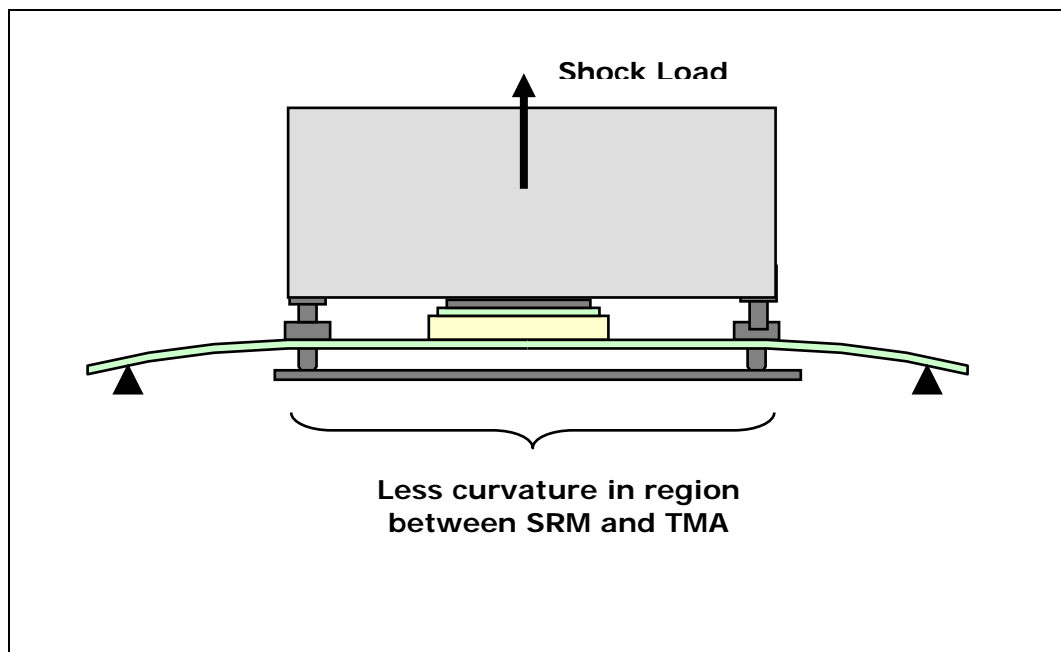
5.6 Preload and TMA Stiffness

5.6.1 Structural Design Strategy

Structural design strategy for the Intel Type II TMA is to minimize upward board deflection during shock to help protect the LGA775 socket.

BTX thermal solutions use the SRM and TMA that together resists local board curvature under the socket and minimize, board deflection (Figure 5-5). In addition, a moderate preload provides initial downward deflection.

Figure 5-5. Upward Board Deflection During Shock



5.6.2 TMA Preload versus Stiffness

The Thermal Module assembly is required to provide a static preload to ensure protection against fatigue failure of socket solder joint. The allowable preload range for BTX platforms is provided in Table 5-4, but the specific target value is a function of the Thermal Module effective stiffness.

The solution space for the Thermal Module effective stiffness and applied preload combinations is shown by the shaded region of Figure 5-6. This solution space shows that the Thermal Module assembly must have an effective stiffness that is sufficiently large such that the minimum preload determined from the relationship requirement in Figure 5-6 does not exceed the maximum allowed preload shown in Table 5-4. Furthermore, if the Thermal Module effective stiffness is so large that the minimum preload determined from Figure 5-6 is below the minimum required value given in Table 5-4, then the Thermal Module should be re-designed to have a preload that lies within the range given in Table 5-4, allowing for preload tolerances.



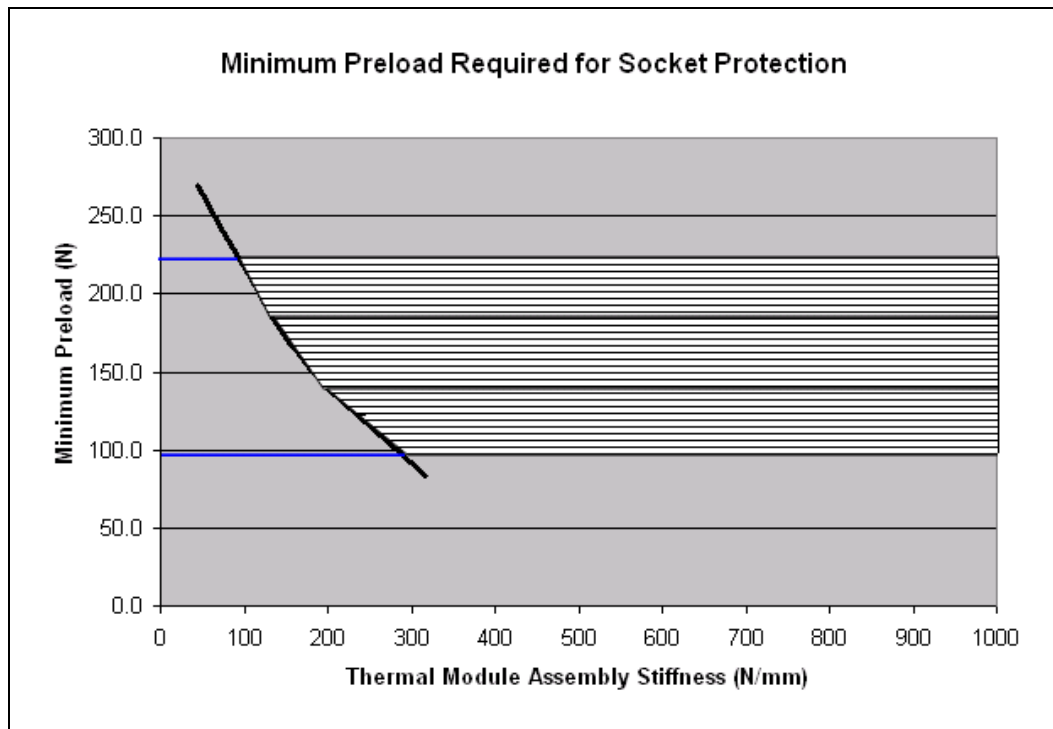
Table 5-4. Processor Preload Limits

Parameter	Minimum Required	Maximum Allowed	Notes
Processor Preload	98 N [22 lbf]	222 N [50 lbf]	1

NOTES:

1. These values represent upper and lower bounds for the processor preload. The nominal preload design point for the Thermal Module is based on a combination of requirements of the TIM, ease of assembly and the Thermal Module effective stiffness.

Figure 5-6. Minimum Required Processor Preload to Thermal Module Assembly Stiffness



NOTES:

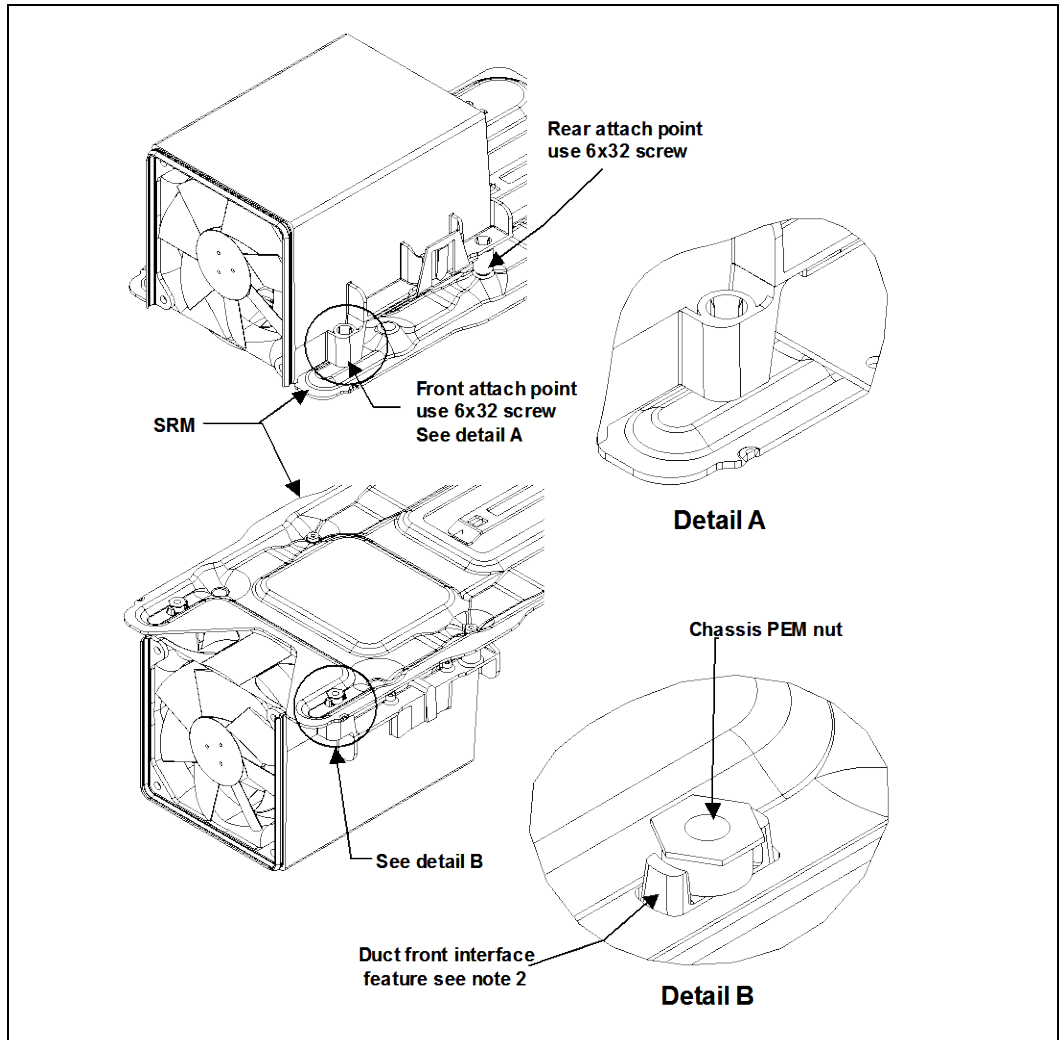
1. The shaded region shown is the acceptable domain for Thermal Module assembly effective stiffness and processor preload combinations. The Thermal Module design should have a design preload and stiffness that lies within this region. The design tolerance for the preload and TMA stiffness should also reside within this boundary. Note that the lower and upper horizontal boundaries represent the preload limits provided in Table 5-4. The equation for the left hand boundary is described in note 2.
2. The equation for this section of the preload-Thermal Module stiffness boundary is given by the following relationship: $\text{Min Preload} = 1.38E-3 * k^2 - 1.18486k + 320.24753$ for $k < 300 \text{ N/mm}$ where k is the Thermal Module assembly effective stiffness. Note that this equation is only valid in the stiffness domain of $93 \text{ N/mm} < k < 282 \text{ N/mm}$. This equation would not apply, for example, for TMA stiffness less than 93 N/mm .
3. The target stiffness for the 65W Type II TMA reference design is 484 N/mm (2764 lb / in).

Note: These preload and stiffness recommendations are specific to the TMA mounting scheme that meets the *BTX Interface Specification and Support Retention Mechanism (SRM) Design Guide*. For TMA mounting schemes that use only the motherboard



mounting hole position for TMA attach, the required preload is approximately 10–15N greater than the values stipulated in Figure 5-6; however, Intel has not conducted any validation testing with this TMA mounting scheme.

Figure 5-7. Thermal Module Attach Points and Duct-to-SRM Interface Features



NOTES:

1. For clarity the motherboard is not shown in this figure. In an actual assembly, the captive 6x32 screws in the thermal module pass through the rear holes in the motherboard designated in the socket keep-in Figure 7-43 through Figure 7-47 in Appendix G and screw into the SRM and chassis PEM features.
2. This front duct ramp feature has both outer and inner lead-in that allows the feature to slide easily into the SRM slot and around the chassis PEM nut. Note that the front PEM nut is part of the chassis not the SRM.



6 ATX Thermal/Mechanical Design Information

6.1 ATX Reference Design Requirements

This chapter will document the requirements for an active air-cooled design, with a fan installed at the top of the heatsink. The thermal technology required for the processor.

The Intel Core™2 Duo processor E8000, E7000 series, Intel Pentium dual-core processor E6000, E5000 series, and Intel® Celeron® processor E3000 series require a thermal solution equivalent to the E18764-001 reference design; see Figure 6-1 for an exploded view of this reference design.

Note: The part number E18764-001 provided in this document is for reference only. The revision number -001 may be subject to change without notice.

The E18764-001 reference design takes advantage of an acoustic improvement to reduce the fan speed to show the acoustic advantage (its acoustic results show in the Table 6–2).

The E18764-001 reference design takes advantage of the cost savings for the several features of the design including the reduced heatsink height, inserted aluminum core and the new TIM material (Dow Corning TC-1996 grease), see Figure 6-2. The overall 46 mm height thermal solution supports the unique and smaller desktop PCs including small and ultra small form factors, down to the 5L size, see *uATX SFF Guidance* for additional details on uATX SFF design.

Figure 6-1. E18764-001 Reference Design – Exploded View

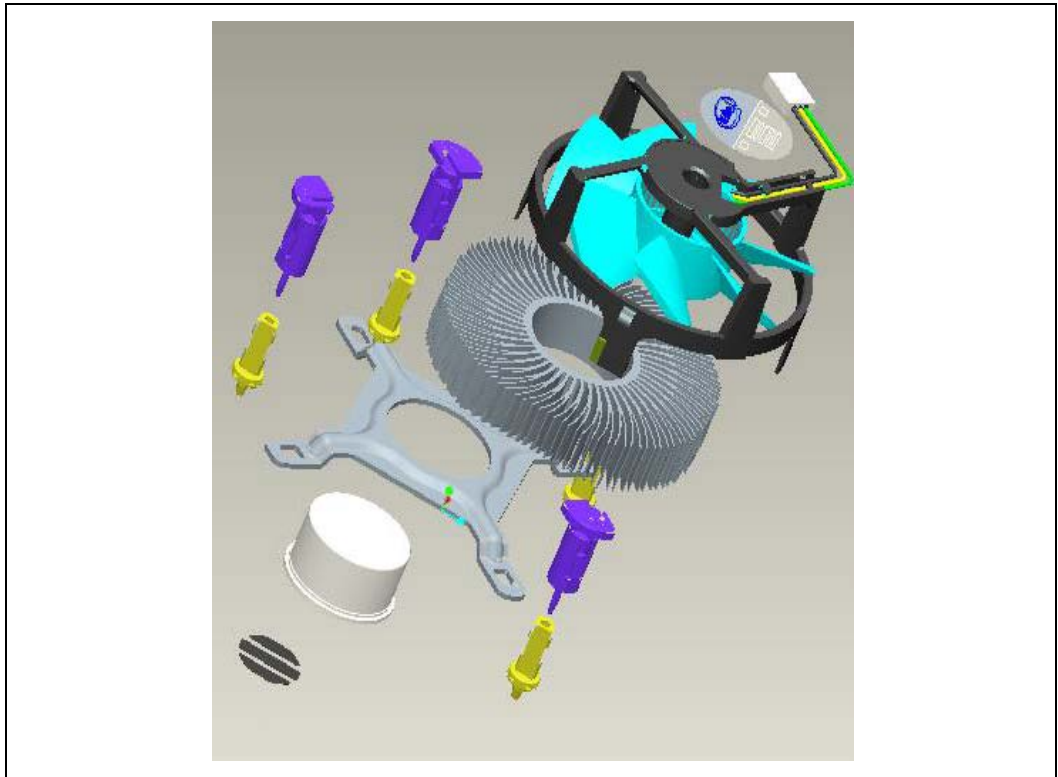


Figure 6-2. Bottom View of Copper Core Applied by TC-1996 Grease



The ATX motherboard keep-out and the height recommendations defined Section 6.6 remain the same for a thermal solution for the processor in the 775-Land LGA package.

Note: If this fan design is used in your product and you will deliver it to end use customers, you have the responsibility to determine an adequate level of protection (such as, protection barriers, a cage, or an interlock) against contact with the energized fan by the user during user servicing.

Note: Development vendor information for the reference design is provided in Appendix H.



6.2 Validation Results for Reference Design

6.2.1 Heatsink Performance

Table 6–1 provides the E18764-001 heatsink performance for the processors of Intel Core™2 Duo processor E8000 series with 6 MB cache, Intel Core™2 Duo processor E7000 series with 3 MB cache, Intel Pentium dual-core processor E6000, E5000 series with 2 MB cache, and Intel® Celeron® processor E3000 series with 1 MB cache. The results are based on the test procedure described in Section 6.2.4.

The tables also include a T_A assumption of 40 °C for the Intel reference thermal solution at the processor fan heatsink inlet discussed Section 2.4.1.

Table 6–1. E18764-001 Reference Heatsink Performance

Processor	Target Thermal Performance, Ψ_{ca} (Mean + 3 σ)	T_A Assumption	Notes
Intel Core™2 Duo processor E8000 series with 6 MB cache	0.50 °C/W	40 °C	1, 2
Intel Core™2 Duo processor E7000 series with 3 MB cache / Intel Pentium dual-core processor E6000, E5000 series with 2 MB cache / Intel® Celeron® processor E3000 series	0.52 °C/W	40 °C	1, 2

NOTES:

1. Performance targets (Ψ_{ca}) as measured with a live processor at TDP.
2. The difference in Ψ_{ca} between the Intel Core™2 Duo processor E8000 series with 6 MB cache and Intel Core™2 Duo processor E7000 series with 3 MB cache, Intel Pentium dual-core processor E6000, E5000 series with 2 MB cache, and Intel® Celeron® processor E3000 series with 1 MB cache is due to a slight difference in the die size.



6.2.2 Acoustics

To optimize acoustic emission by the fan heatsink assembly, the reference design implements a variable speed fan. A variable speed fan allows higher thermal performance at higher fan inlet temperatures (T_A) and lower thermal performance with improved acoustics at lower fan inlet temperatures. The required fan speed necessary to meet thermal specifications can be controlled by the fan inlet temperature and should comply with requirements in Table 6–2.

Table 6–2. Acoustic Results for ATX Reference Heatsink (E18764-001)

Fan Speed RPM	Thermist or Set Point	Acoustic	Thermal Requirements, Ψ_{ca}	Notes
3900	High $T_A = 40\text{ }^\circ\text{C}$	5.0 BA	<ul style="list-style-type: none"> • 0.50° C/W (Core™2 Duo processor E8000 series 6 MB) • 0.52° C/W (Core™2 Duo processor E7000 series 3 MB, Pentium dual-core processor E6000, E5000 series 2 MB, and Intel® Celeron® processor E3000 series with 1 MB) 	
2000	Low $T_A = 30\text{ }^\circ\text{C}$	3.5 BA	<ul style="list-style-type: none"> • 0.65° C/W (Core™2 Duo processor E8000 series with 6 MB) • 0.68 °C/W (Core™2 Duo processor E7000 series 3 MB, Pentium dual-core processor E6000, E5000 series 2 MB, and Intel® Celeron® processor E3000 series with 1 MB) 	Thermal Design Power, Fan speed limited by the fan hub thermistor

NOTES:

1. Acoustic performance is defined in terms of measured sound power (LwA) as defined in ISO 9296 standard, and measured according to ISO 7779.

While the fan hub thermistor helps optimize acoustics at high processor workloads by adapting the maximum fan speed to support the processor thermal profile, additional acoustic improvements can be achieved at lower processor workload by using the $T_{CONTROL}$ specifications described in Section 2.2.4. Intel recommendation is to use the fan with 4 Wire PWM Controlled to implement fan speed control capability based digital thermal sensor temperature. Refer to Chapter 7 for further details.

Note: Appendix F gives detailed fan performance for the Intel reference thermal solutions with 4 Wire PWM Controlled fan.

6.2.3 Altitude

Many companies design products that must function reliably at high altitude, typically 1,500 m [5,000 ft] or more. Air-cooled temperature calculations and measurements at the test site elevation must be adjusted to take into account altitude effects like variation in air density and overall heat capacity. This often leads to some degradation in thermal solution performance compared to what is obtained at sea level, with lower fan performance and higher surface temperatures. The system designer needs to account for altitude effects in the overall system thermal design to make sure that the T_c requirement for the processor is met at the targeted altitude.



6.2.4 Heatsink Thermal Validation

Intel recommends evaluation of the heatsink within the specific boundary conditions based on the methodology described Section 6.3 , and using a thermal test vehicle.

Testing is done on bench top test boards at ambient lab temperature. In particular, for the reference heatsink, the Plexiglas* barrier is installed 81.28 mm [3.2 in] above the motherboard (refer to Sections 3.3 and 6.6).

The test results, for a number of samples, are reported in terms of a worst-case mean + 3σ value for thermal characterization parameter using real processors (based on the thermal test vehicle correction factors).

Note: The above 81.28 mm obstruction height that is used for testing complies with the recommended obstruction height of 88.9 mm for the ATX form factor. However, it would conflict with systems in strict compliance with the ATX specification which allows an obstruction as low as 76.2 mm above the motherboard surface in Area A.

6.3 Environmental Reliability Testing

6.3.1 Structural Reliability Testing

Structural reliability tests consist of unpackaged, board-level vibration and shock tests of a given thermal solution in the assembled state. The thermal solution should meet the specified thermal performance targets after these tests are conducted; however, the test conditions outlined here may differ from your own system requirements.

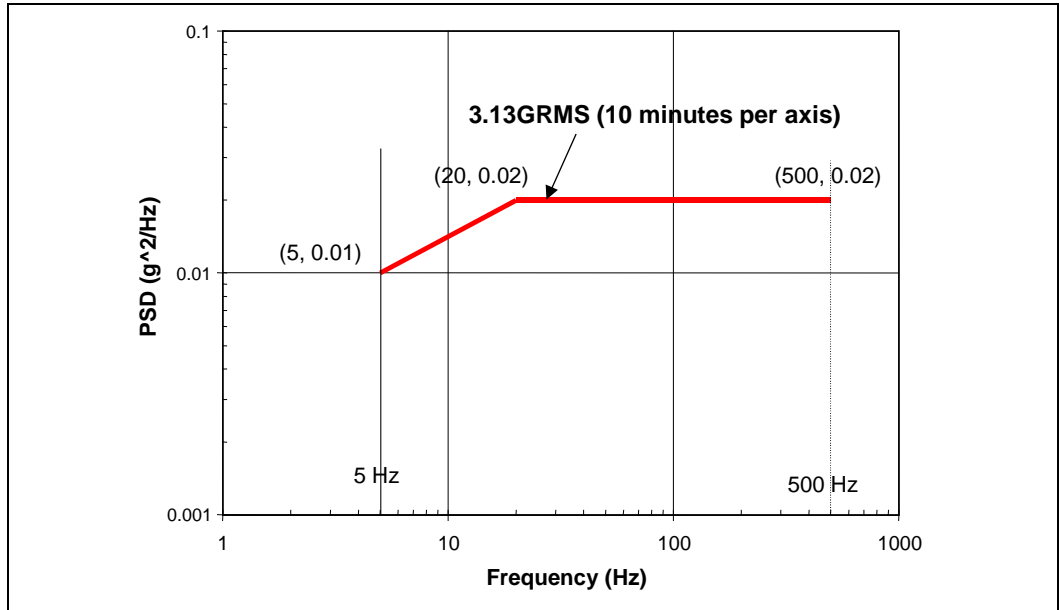
6.3.1.1 Random Vibration Test Procedure

Duration: 10 min/axis, 3 axes

Frequency Range: 5 Hz to 500 Hz

Power Spectral Density (PSD) Profile: 3.13 G RMS

Figure 6-3. Random Vibration PSD

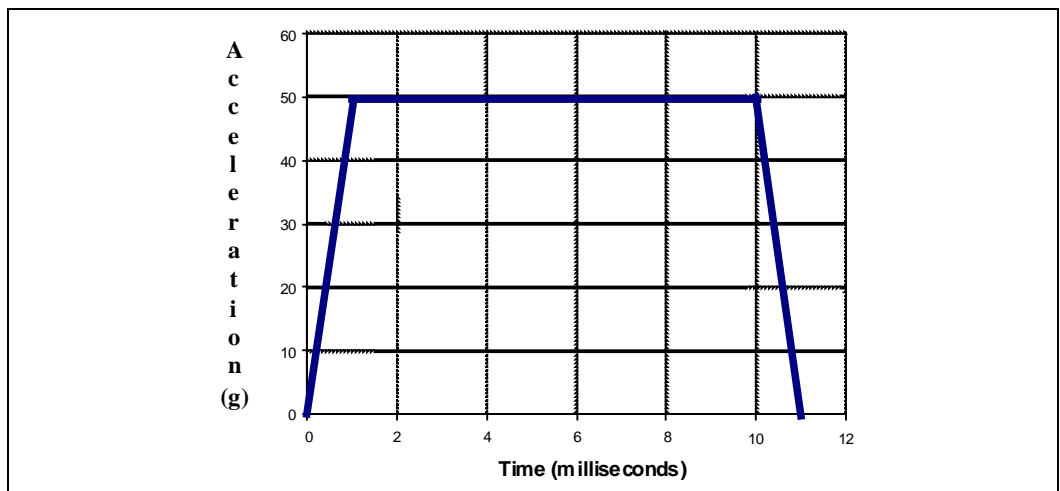


6.3.1.2 Shock Test Procedure

Recommended performance requirement for a motherboard:

- Quantity: 3 drops for + and - directions in each of 3 perpendicular axes (that is, total 18 drops).
- Profile: 50 G trapezoidal waveform, 170 in/sec minimum velocity change.
- Setup: Mount sample board on test fixture.

Figure 6-4. Shock Acceleration Curve





6.3.1.2.1 Recommended Test Sequence

Each test sequence should start with components (that is, motherboard, heatsink assembly, and so forth) that have never been previously submitted to any reliability testing.

The test sequence should always start with a visual inspection after assembly, and BIOS/CPU/Memory test (refer to Section 6.3.3).

Prior to the mechanical shock & vibration test, the units under test should be preconditioned for 72 hours at 45 °C. The purpose is to account for load relaxation during burn-in stage.

The stress test should be followed by a visual inspection and then BIOS/CPU/Memory test.

6.3.1.2.2 Post-Test Pass Criteria

The post-test pass criteria are:

1. No significant physical damage to the heatsink attach mechanism (including such items as clip and motherboard fasteners).
2. Heatsink must remain attached to the motherboard.
3. Heatsink remains seated and its bottom remains mated flatly against IHS surface. No visible gap between the heatsink base and processor IHS. No visible tilt of the heatsink with respect to its attach mechanism.
4. No signs of physical damage on motherboard surface due to impact of heatsink or heatsink attach mechanism.
5. No visible physical damage to the processor package.
6. Successful BIOS/Processor/memory test of post-test samples.
7. Thermal compliance testing to demonstrate that the case temperature specification can be met.

6.3.2 Power Cycling

Thermal performance degradation due to TIM degradation is evaluated using power cycling testing. The test is defined by 7500 cycles for the case temperature from room temperature (~23 °C) to the maximum case temperature defined by the thermal profile at TDP.



6.3.3 Recommended BIOS/CPU/Memory Test Procedures

This test is to ensure proper operation of the product before and after environmental stresses, with the thermal mechanical enabling components assembled. The test shall be conducted on a fully operational motherboard that has not been exposed to any battery of tests prior to the test being considered.

Testing setup should include the following components, properly assembled and/or connected:

- Appropriate system motherboard
- Processor
- All enabling components, including socket and thermal solution parts
- Power supply
- Disk drive
- Video card
- DIMM
- Keyboard
- Monitor

The pass criterion is that the system under test shall successfully complete the checking of BIOS, basic processor functions and memory, without any errors.

6.4 Material and Recycling Requirements

Material shall be resistant to fungal growth. Examples of non-resistant materials include cellulose materials, animal and vegetable based adhesives, grease, oils, and many hydrocarbons. Synthetic materials such as PVC formulations, certain polyurethane compositions (such as, polyester and some polyethers), plastics that contain organic fillers of laminating materials, paints, and varnishes also are susceptible to fungal growth. If materials are not fungal growth resistant, then MIL-STD-810E, Method 508.4 must be performed to determine material performance.

Material used shall not have deformation or degradation in a temperature life test.

Any plastic component exceeding 25 grams must be recyclable per the European Blue Angel recycling standards.



6.5 Safety Requirements

Heatsink and attachment assemblies shall be consistent with the manufacture of units that meet the safety standards:

- UL Recognition-approved for flammability at the system level. All mechanical and thermal enabling components must be a minimum UL94V-2 approved.
- CSA Certification. All mechanical and thermal enabling components must have CSA certification.
- All components (in particular the heatsink fins) must meet the test requirements of UL1439 for sharp edges.
- If the International Accessibility Probe specified in IEC 950 can access the moving parts of the fan, consider adding safety feature so that there is no risk of personal injury.

6.6 Geometric Envelope for Intel® Reference ATX Thermal Mechanical Design

Figure 7-40, Figure 7-41, and Figure 7-42 in Appendix G provides detailed reference ATX/μATX motherboard keep-out information for the reference thermal/mechanical enabling design. These drawings include height restrictions in the enabling component region.

The maximum height of the reference solution above the motherboard is 71.12 mm [2.8 inches], and is compliant with the motherboard primary side height constraints defined in the *ATX Specification revision 2.1* and the *microATX Motherboard Interface Specification revision 1.1* found at <http://www.formfactors.org>. The reference solution requires a chassis obstruction height of at least 81.28 mm [3.2 inches], measured from the top of the motherboard (refer to Sections 3.3 and 6.2.4). This allows for appropriate fan inlet airflow to ensure fan performance, and therefore overall cooling solution performance. This is compliant with the recommendations found in both *ATX Specification V2.1* and *microATX Motherboard Interface Specification V1.1* documents.

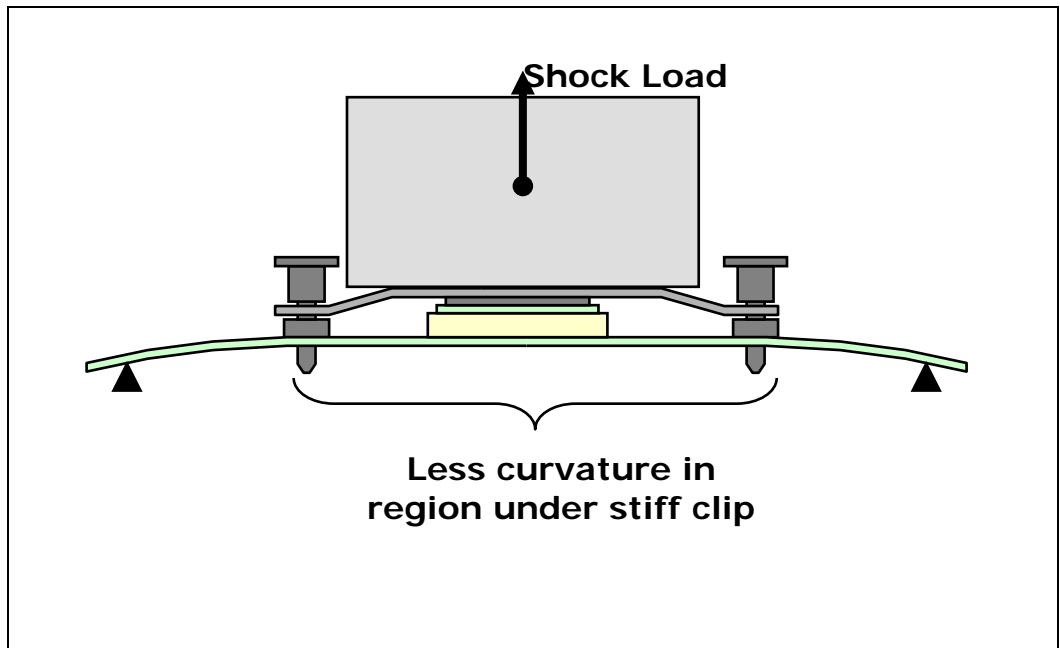
6.7 Reference Attach Mechanism

6.7.1 Structural Design Strategy

Structural design strategy for the reference design is to minimize upward board deflection during shock to help protect the LGA775 socket.

The reference design uses a high clip stiffness that resists local board curvature under the heatsink, and minimizes, in particular, upward board deflection (Figure 6-5). In addition, a moderate preload provides initial downward deflection.

Figure 6-5. Upward Board Deflection during Shock



The target metal clip nominal stiffness is 540 N/mm [3100 lb/in]. The combined target for reference clip and fasteners nominal stiffness is 380 N/mm [2180 lb/in]. The nominal preload provided by the reference design is 191.3 N \pm 44.5 N [43 lb \pm 10 lb].

Note: Intel reserves the right to make changes and modifications to the design as necessary to the reference design, in particular the clip and fastener.



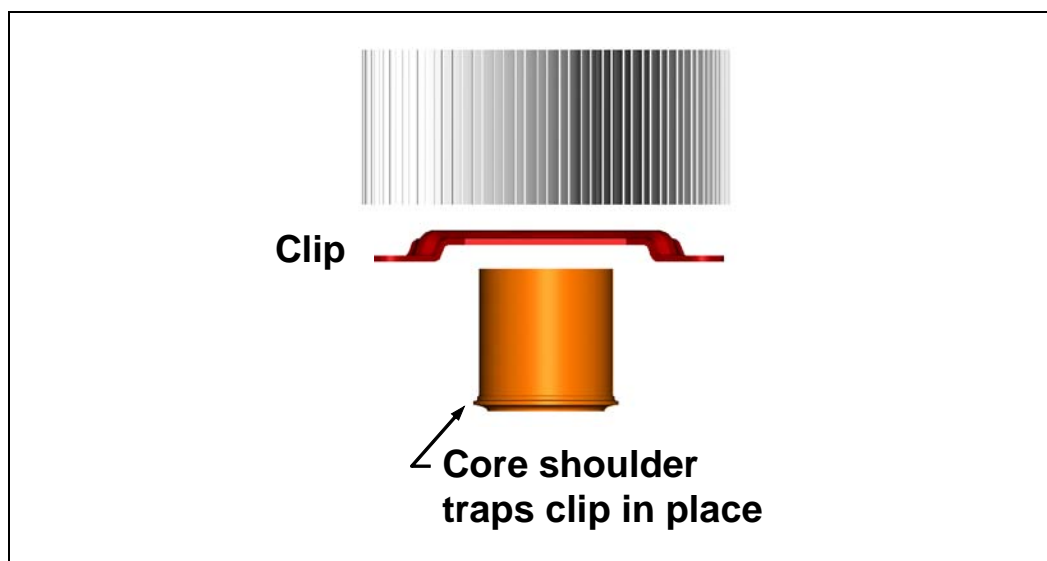
6.7.2 Mechanical Interface to the Reference Attach Mechanism

The attach mechanism component from the reference design can be used by other 3rd party cooling solutions. The attach mechanism consists of:

- A metal attach clip that interfaces with the heatsink core, see Appendix G, Figure 7-48 and Figure 7-49 for the component drawings.
- Four plastic fasteners, see Appendix G, Figure 7-50, Figure 7-51, Figure 7-52 and Figure 7-53 for the component drawings.

The clip is assembled to heatsink during copper core insertion, and is meant to be trapped between the core shoulder and the extrusion as shown in Figure 6-6.

Figure 6-6. Reference Clip/Heatsink Assembly



The mechanical interface with the reference attach mechanism is defined in Figure 6-7 and Figure 6-8. Complying with the mechanical interface parameters is critical to generating a heatsink preload compliant with the minimum preload requirement given in Section 2.1.2.2.

Additional requirements for the reference attach mechanism (clip and fasteners) include:

- Heatsink/fan mass \leq 550 g (that is, total assembly mass, including clip and fasteners $<$ 595 g)
- Whole assembly center of gravity \leq 25.4 mm, measured from the top of the IHS
— Whole assembly = Heatsink + Fan + Attach clip + Fasteners

Figure 6-7. Critical Parameters for Interfacing to Reference Clip

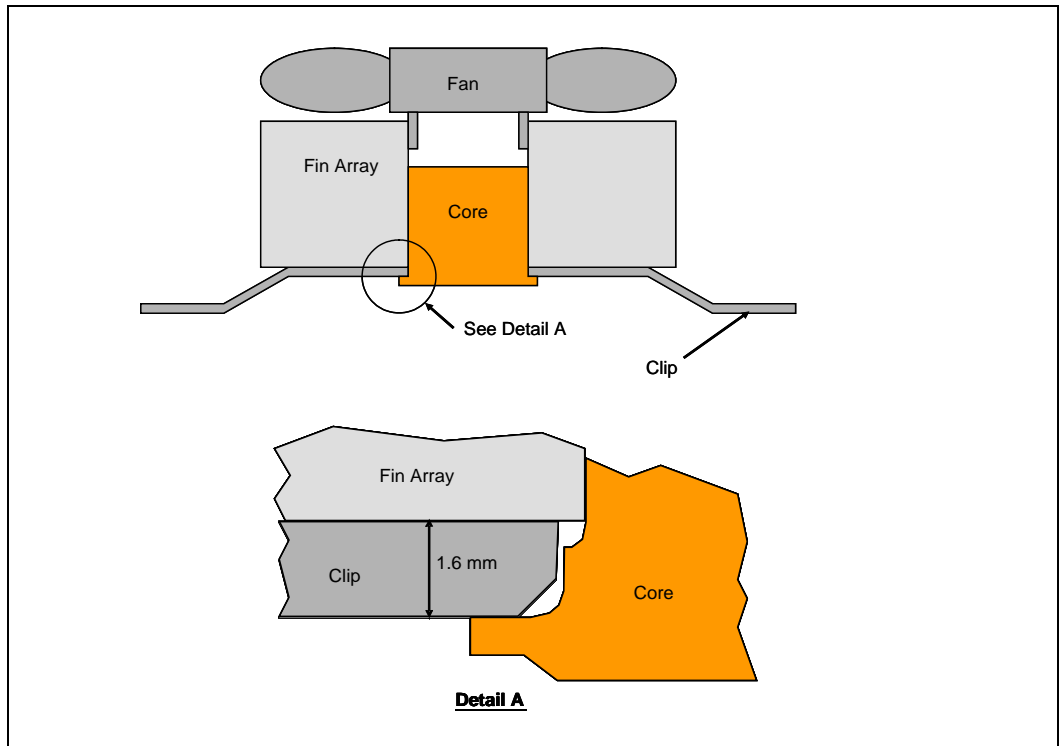
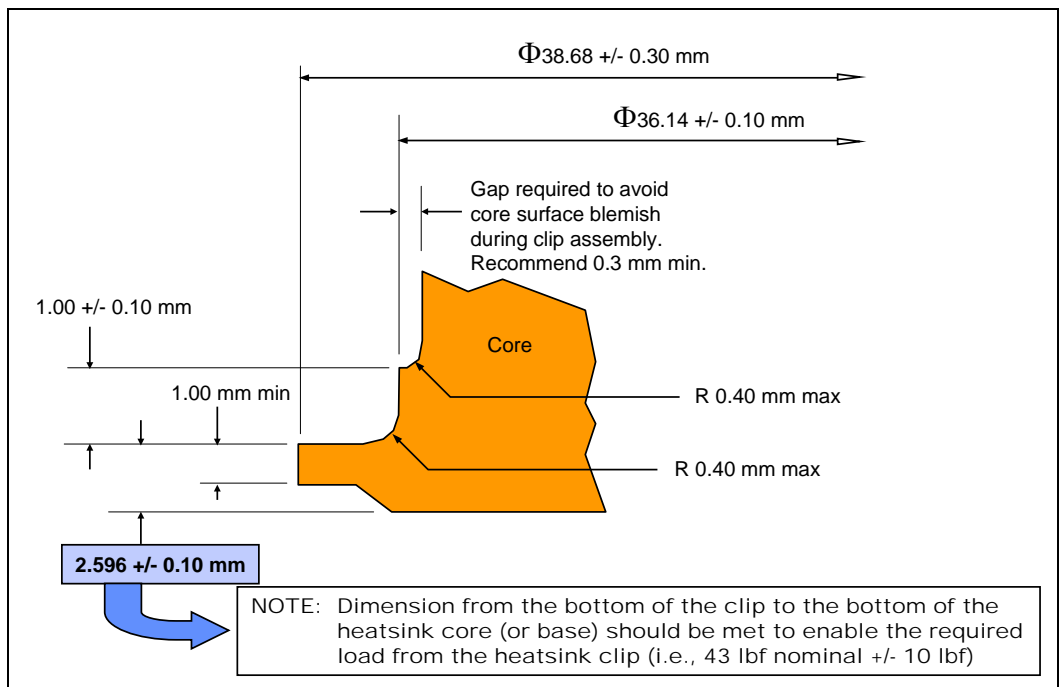


Figure 6-8. Critical Core Dimension





7 Intel® Quiet System Technology (Intel® QST)

In the Intel 965 Express Family Chipset a new control algorithm for fan speed control is being introduced. It is composed of an Intel Management Engine (ME) in the Graphics Memory Controller Hub (GMCH) which executes the Intel Quiet System Technology (Intel QST) algorithm and the ICH8 containing the sensor bus and fan control circuits.

The ME provides integrated fan speed control in lieu of the mechanisms available in a SIO or a stand-alone ASIC. The Intel QST is time based as compared to the linear or state control used by the current generation of FSC devices.

A short discussion of Intel QST will follow along with thermal solution design recommendations. For a complete discussion of programming the Intel QST in the ME Consult the *Intel® Quiet System Technology (Intel® QST) Configuration and Tuning Manual*.

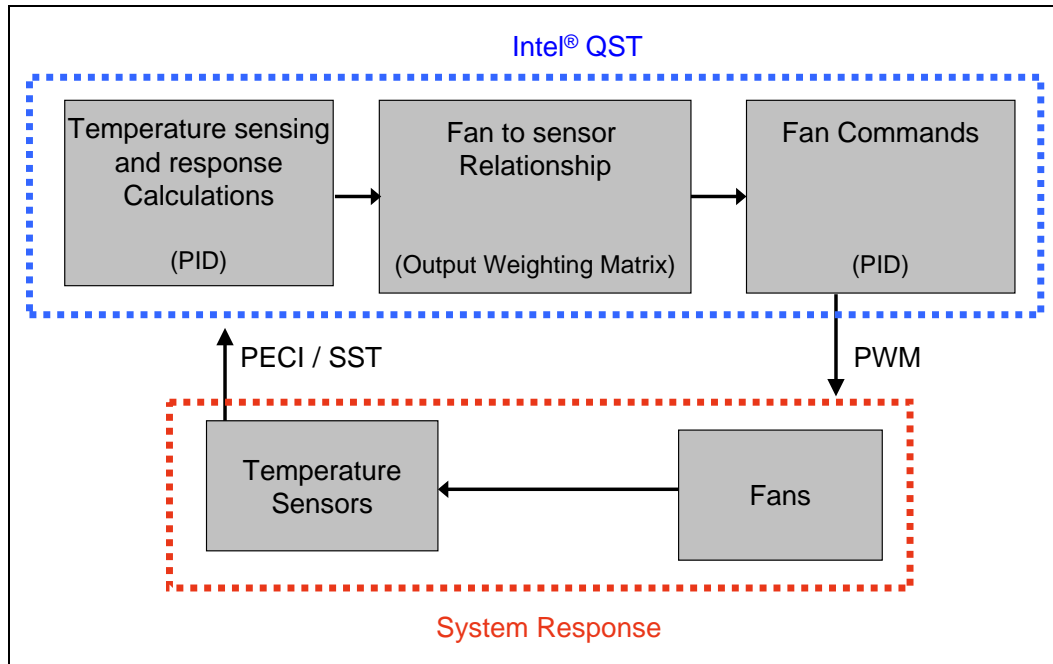
Note: Fan speed control algorithms and Intel QST in particular rely on a thermal solution being compliant to the processor thermal profile. It is unlikely that any fan speed control algorithm can compensate for a non-compliant thermal solution. See Chapter 5 and Chapter 6 for thermal solution requirements that should be met before evaluating or configuring a system with Intel QST.

7.1 Intel® QST Algorithm

The objective of Intel QST is to minimize the system acoustics by more closely controlling the thermal sensors to the corresponding processor or chipset device T_{CONTROL} value. This is achieved by the use of a Proportional-Integral-Derivative (PID) control algorithm and a Fan Output Weighting Matrix. The PID algorithm takes into account the difference between the current temperature and the target (T_{CONTROL}), the rate of change and direction of change to minimize the required fan speed change. The Fan Output Weighting Matrix uses the effects of each fan on a thermal sensor to minimize the required fan speed changes.

Figure 7-1 shows in a very simple manner how Intel QST works. See the *Intel Quiet System Technology (Intel® QST) Configuration and Tuning Manual* for a detail discussion of the inputs and response.

Figure 7-1. Intel® QST Overview



7.1.1 Output Weighting Matrix

Intel QST provides an Output Weighting Matrix that provides a means for a single thermal sensor to affect the speed of multiple fans. An example of how the matrix could be used is if a sensor located next to the memory is sensitive to changes in both the processor heatsink fan and a 2nd fan in the system. By placing a factor in this matrix additional, the Intel QST could command the processor thermal solution fan and this 2nd fan to both accelerate a small amount. At the system level these two small changes can result in a smaller change in acoustics than having a single fan respond to this sensor.

7.1.2 Proportional-Integral-Derivative (PID)

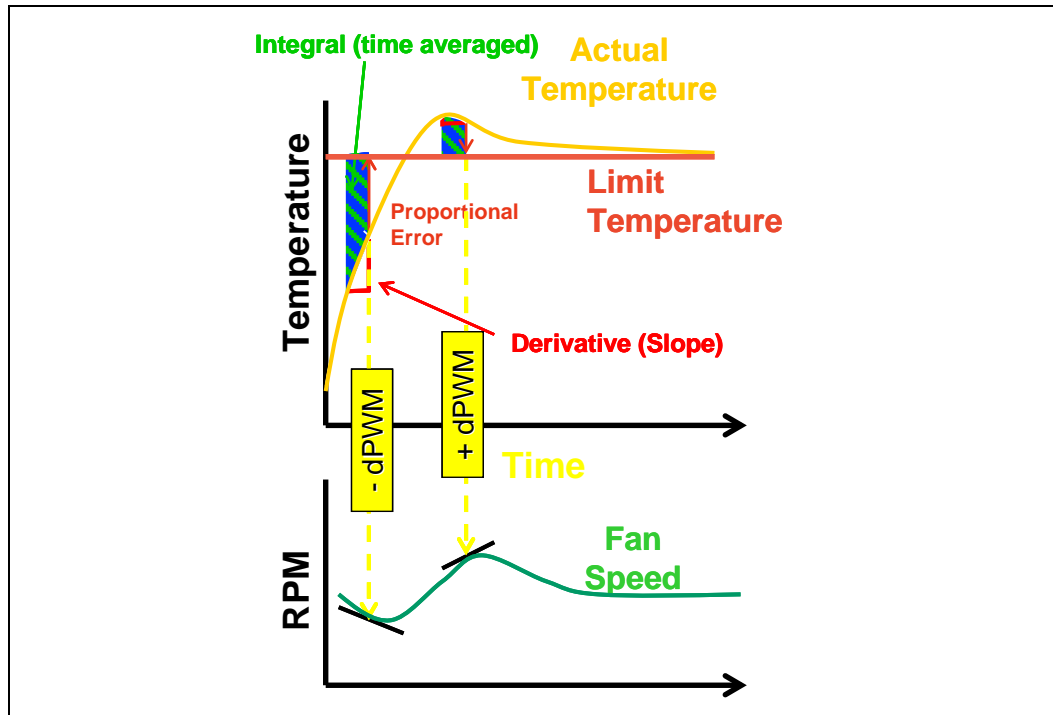
The use of Proportional-Integral-Derivative (PID) control algorithms allow the magnitude of fan response to be determined based upon the difference between current temperature readings and specific temperature targets. A major advantage of a PID Algorithm is the ability to control the fans to achieve sensor temperatures much closer to the $T_{CONTROL}$.

Figure 7-2 is an illustration of the PID fan control algorithm. As illustrated in the figure, when the actual temperature is below the target temperature, the fan will slow down. The current FSC devices have a fixed temperature versus PWM output relationship and miss this opportunity to achieve additional acoustic benefits. As the actual temperature starts ramping up and approaches the target temperature, the algorithm will instruct the fan to speed up gradually, but will not abruptly increase the fan speed to respond to the condition. It can allow an overshoot over the target temperature for a short period of time while ramping up the fan to bring the actual



temperature to the target temperature. As a result of its operation, the PID control algorithm can enable an acoustic-friendly platform.

Figure 7-2. PID Controller Fundamentals



For a PID algorithm to work limit temperatures are assigned for each temperature sensor. For Intel QST, the T_{CONTROL} for the processor and chipset are to be used as the limit temperature. The ME will measure the error, slope and rate of change using the equations below:

- Proportional Error (P) = $T_{\text{LIMIT}} - T_{\text{ACTUAL}}$
- Integral (I) = Time averaged error
- Derivative (D) = $\Delta\text{Temp} / \Delta\text{Time}$

Three gain values are used to control response of algorithm.

- K_p = proportional gain
- K_i = Integral gain
- K_d = derivative gain

The *Intel® Quiet System Technology (Intel® QST) Configuration and Tuning Manual* provides initial values for the each of the gain constants. In addition it provides a methodology to tune these gain values based on system response.

Finally, the fan speed change will be calculated using the following formula:

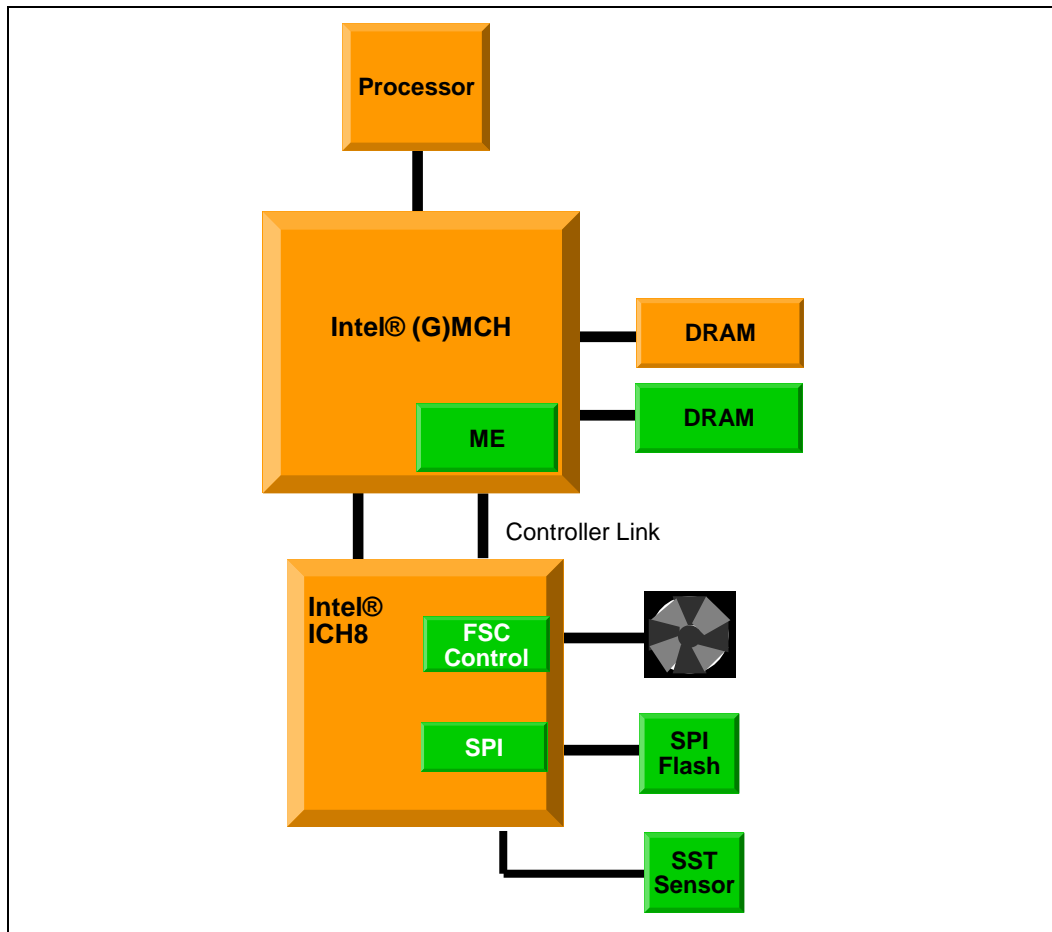
$$\Delta\text{PWM} = -P*(K_p) - I*(K_i) + D*(K_d)$$

7.2 Board and System Implementation of Intel® QST

To implement Intel QST, the board must be configured as shown in Figure 7-3 and listed below:

- ME system (S0–S1) with Controller Link connected and powered
- DRAM with Channel A DIMM 0 installed and 2 MB reserved for Intel QST FW execution
- SPI Flash with sufficient space for the Intel QST Firmware
- SST-based thermal sensors to provide board thermal data for Intel QST algorithms
- Intel QST firmware

Figure 7-3. Intel® QST Platform Requirements

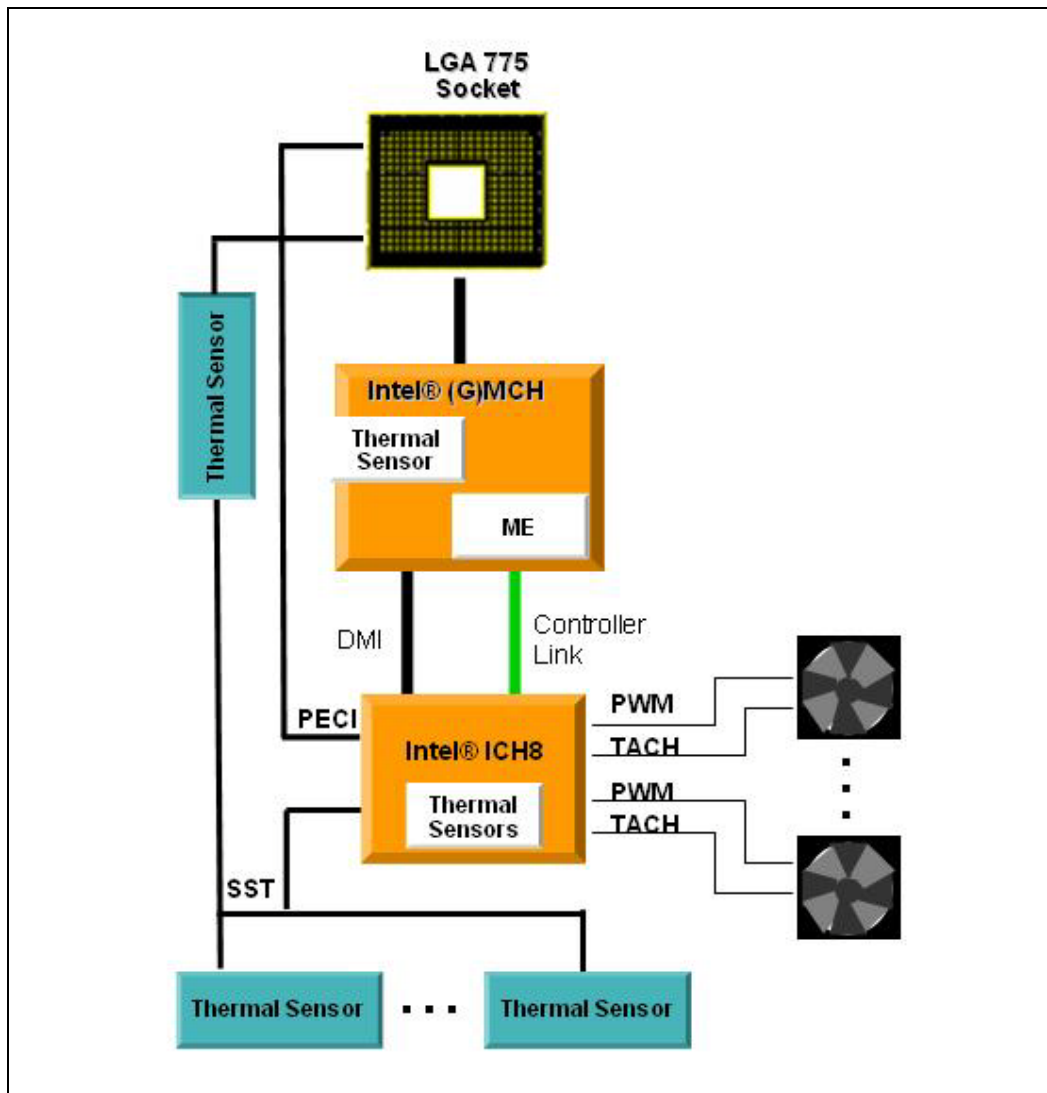


Note: Simple Serial Transport (SST) is a single wire bus that is included in the ICH8 to provide additional thermal and voltage sensing capability to the Intel Management Engine (ME).



Figure 7-4 shows the major connections for a typical implementation that can support processors with Digital thermal sensor or a thermal diode. In this configuration a SST Thermal Sensor has been added to read the on-die thermal diode that is in all of the processors in the 775-land LGA packages shipped before the Intel Core™2 Duo processor. With the proper configuration information, the ME can accommodate inputs from PECL or SST for the processor socket. Additional SST sensors can be added to monitor system thermal (see 0 for BTX recommendations for placement).

Figure 7-4. Example Acoustic Fan Speed Control Implementation



Intel has engaged with a number of major manufacturers of thermal / voltage sensors to provide devices for the SST bus. Contact your Intel Field Sales representative for the current list of manufacturers and visit their web sites or local sales representatives for a part suitable for your design.



7.3 Intel® QST Configuration and Tuning

Initial configuration of the Intel QST is the responsibility of the board manufacturer. The SPI flash should be programmed with the hardware configuration of the motherboard and initial settings for fan control, fan monitoring, voltage and thermal monitoring. This initial data is generated using the Intel provided Configuration Tool.

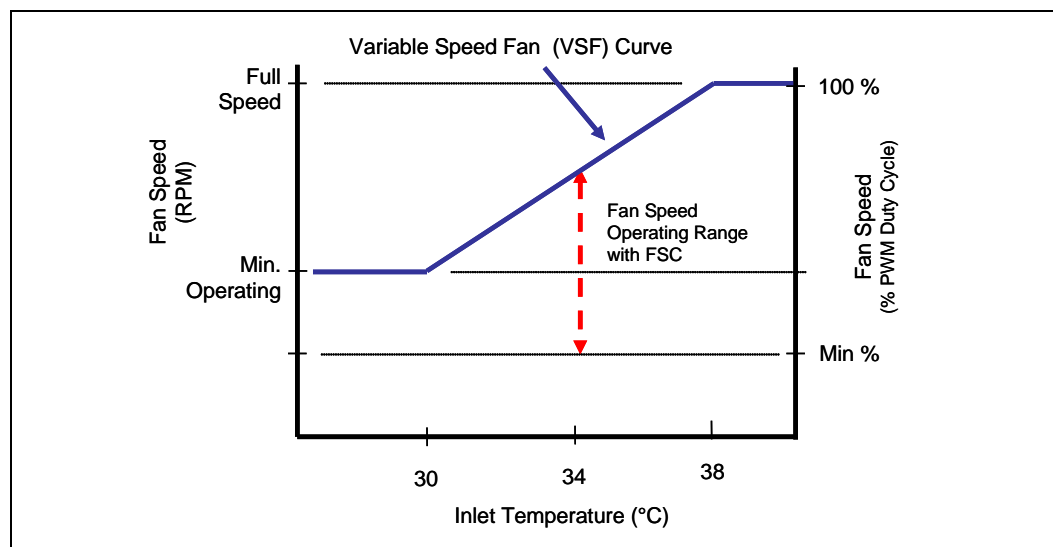
At the system integrator, the Configuration Tool can be used again but this time to tune the Intel QST subsystem to reflect the shipping system configuration. In the tuning process the Intel QST can be modified to have the proper relationships between the installed fans and sensors in the shipping system. A Weighting Matrix Utility and Intel QST Log program are planned to assist in optimizing the fan management and achieve acoustic goal.

Contact your Intel field sales representative for availability of these tools.

7.4 Fan Hub Thermistor and Intel® QST

There is no closed loop control between Intel QST and the thermistor; however, they can work in tandem to provide the maximum fan speed reduction. The BTX reference design includes a thermistor on the fan hub. This Variable Speed Fan curve will determine the maximum fan speed as a function of the inlet ambient temperature and by design provides a Ψ_{CA} sufficient to meet the thermal profile of the processor. Intel QST, by measuring the processor Digital thermal sensor, will command the fan to reduce speed below the VSF curve in response to processor workload. Conversely if the processor workload increases, the FSC will command the fan using the PWM duty cycle to accelerate the fan up to the limit imposed by the VSF curve. Care needs to be taken in BTX designs to ensure the fan speed at the minimum operating speed provides sufficient air flow to support the other system components.

Figure 7-5. Digital Thermal Sensor and Thermistor





Appendix A LGA775 Socket Heatsink Loading

A.1 LGA775 Socket Heatsink Considerations

Heatsink clip load is traditionally used for:

- Mechanical performance in mechanical shock and vibration
 - Refer to Section 6.7.1 for the information on the structural design strategy for the reference design
- Thermal interface performance
 - Required preload depends on TIM
 - Preload can be low for thermal grease

In addition to mechanical performance in shock and vibration and TIM performance, LGA775 socket requires a minimum heatsink preload to protect against fatigue failure of socket solder joints.

Solder ball tensile stress is originally created when, after inserting a processor into the socket, the LGA775 socket load plate is actuated. In addition, solder joint shear stress is caused by coefficient of thermal expansion (CTE) mismatch induced shear loading. The solder joint compressive axial force (F_{axial}) induced by the heatsink preload helps to reduce the combined joint tensile and shear stress.

Overall, the heatsink required preload is the minimum preload needed to meet all of the above requirements—Mechanical shock and vibration and TIM performance AND LGA775 socket protection against fatigue failure.

A.2 Metric for Heatsink Preload for ATX/uATX Designs Non-Compliant with Intel[®] Reference Design

A.3 Heatsink Preload Requirement Limitations

Heatsink preload by itself is not an appropriate metric for solder joint force across various mechanical designs and does not take into account for example (not an exhaustive list):

- Heatsink mounting hole span
- Heatsink clip/fastener assembly stiffness and creep
- Board stiffness and creep
- Board stiffness is modified by fixtures like backing plate, chassis attach, and so forth.



Simulation shows that the solder joint force (F_{axial}) is proportional to the board deflection measured along the socket diagonal. The matching of F_{axial} required to protect the LGA775 socket solder joint in temperature cycling is equivalent to matching a target MB deflection.

Therefore, the heatsink preload for LGA775 socket solder joint protection against fatigue failure can be more generally defined as the load required to create a target board downward deflection throughout the life of the product

This board deflection metric provides guidance for mechanical designs that differ from the reference design for ATX// μ ATX form factor.

A.3.1 Motherboard Deflection Metric Definition

Motherboard deflection is measured along either diagonal (refer to Figure 7-6):

$$d = d_{max} - (d_1 + d_2)/2$$

$$d' = d_{max} - (d'_1 + d'_2)/2$$

Configurations in which the deflection is measured are defined in the Table 7–1.

To measure board deflection, follow industry standard procedures (such as IPC) for board deflection measurement. Height gauges and possibly dial gauges may also be used.

Table 7–1. Board Deflection Configuration Definitions

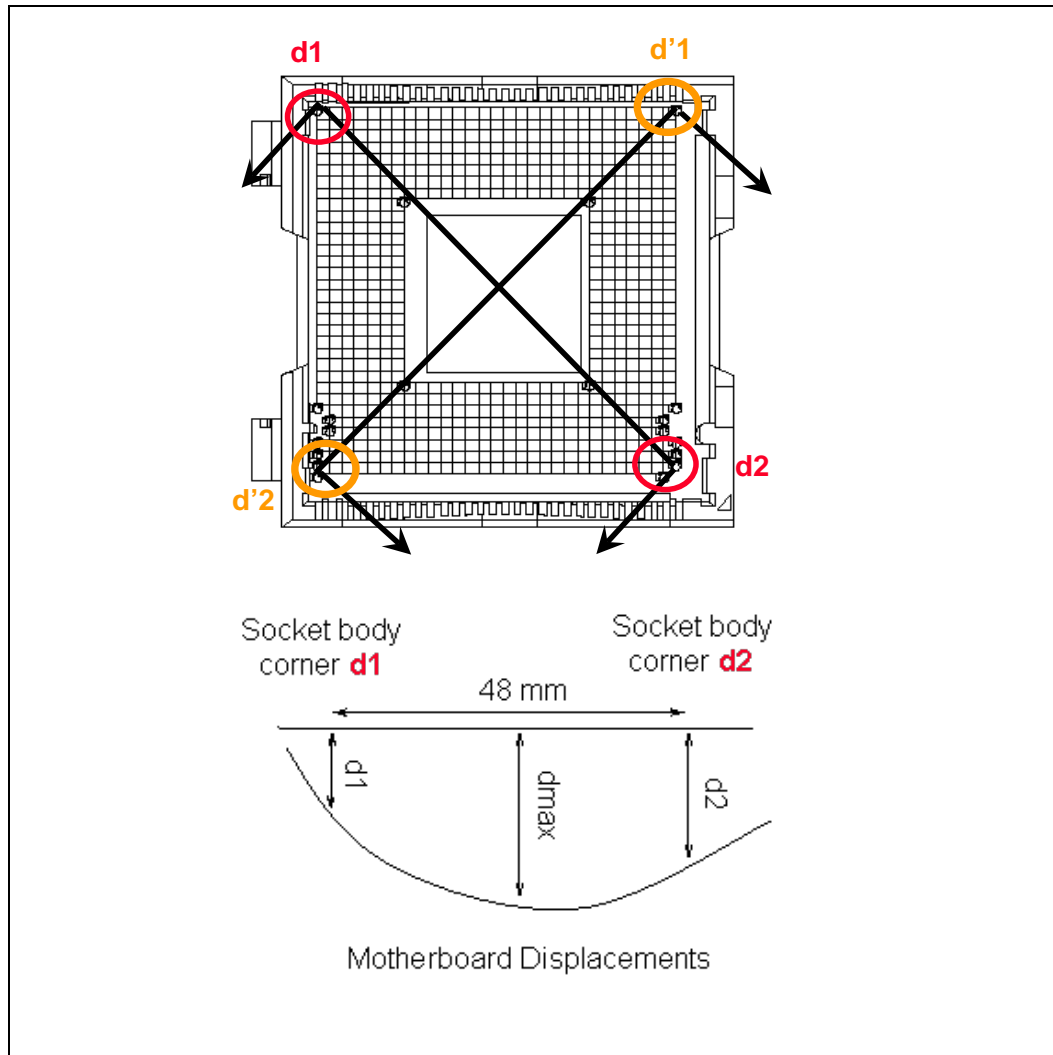
Configuration Parameter	Processor + Socket load plate	Heatsink	Parameter Name
d_ref	yes	no	BOL deflection, no preload
d_BOL	yes	yes	BOL deflection with preload
d_EOL	yes	yes	EOL deflection

NOTES:

BOL: Beginning of Life

EOL: End of Life

Figure 7-6. Board Deflection Definition



A.3.2 Board Deflection Limits

Deflection limits for the ATX/μATX form factor are:

$$d_{\text{BOL}} - d_{\text{ref}} \geq 0.09 \text{ mm} \quad \text{and} \quad d_{\text{EOL}} - d_{\text{ref}} \geq 0.15 \text{ mm}$$

And

$$d'_{\text{BOL}} - d'_{\text{ref}} \geq 0.09 \text{ mm} \quad \text{and} \quad d'_{\text{EOL}} - d'_{\text{ref}} \geq 0.15 \text{ mm}$$

NOTES:

1. The heatsink preload must remain within the static load limits defined in the processor datasheet at all times.
2. Board deflection should not exceed motherboard manufacturer specifications.



A.3.3 Board Deflection Metric Implementation Example

This section is for illustration only, and relies on the following assumptions:

- 72 mm x 72 mm hole pattern of the reference design
- Board stiffness = 900 lb/in at BOL, with degradation that simulates board creep over time
- Though these values are representative, they may change with selected material and board manufacturing process. Check with your motherboard vendor.
- Clip stiffness assumed constant – No creep.

Using Figure 7-7, the heatsink preload at beginning of life is defined to comply with $d_{EOL} - d_{ref} = 0.15$ mm depending on clip stiffness assumption.

Note that the BOL and EOL preload and board deflection differ. This is a result of the creep phenomenon. The example accounts for the creep expected to occur in the motherboard. It assumes no creep to occur in the clip. However, there is a small amount of creep accounted for in the plastic fasteners. This situation is somewhat similar to the reference design.

The impact of the creep to the board deflection is a function of the clip stiffness:

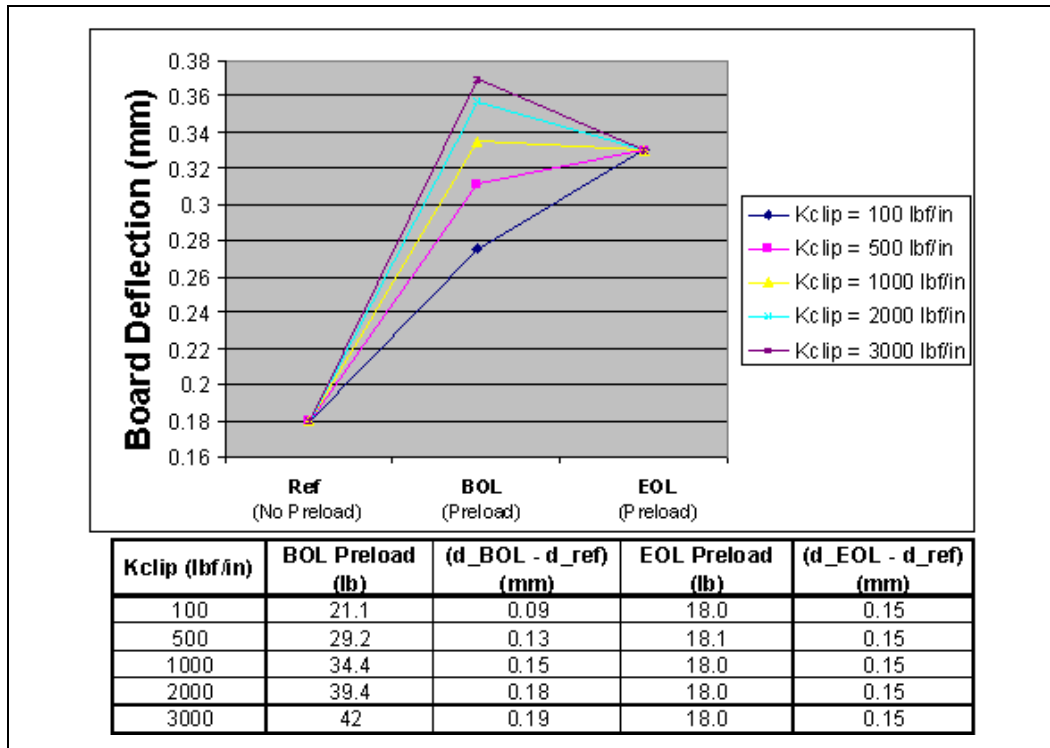
- The relatively compliant clips store strain energy in the clip under the BOL preload condition and tend to generate increasing amounts of board deflection as the motherboard creeps under exposure to time and temperature.
- In contrast, the stiffer clips stores very little strain energy, and therefore do not generate substantial additional board deflection through life.

NOTES:

1. Board and clip creep modify board deflection over time and depends on board stiffness, clip stiffness, and selected materials.
2. Designers must define the BOL board deflection that will lead to the correct end of life board deflection.



Figure 7-7. Example—Defining Heatsink Preload Meeting Board Deflection Limit



A.3.4 Additional Considerations

Intel recommends to design to $\{d_{BOL} - d_{ref} = 0.15 \text{ mm}\}$ at BOL when EOL conditions are not known or difficult to assess

The following information is given for illustration only. It is based on the reference keep-out, assuming there is no fixture that changes board stiffness:

d_{ref} is expected to be 0.18 mm on average, and be as high as 0.22 mm

As a result, the board should be able to deflect 0.37 mm minimum at BOL

Additional deflection as high as 0.09 mm may be necessary to account for additional creep effects impacting the board/clip/fastener assembly. As a result, designs could see as much as 0.50 mm total downward board deflection under the socket.

In addition to board deflection, other elements need to be considered to define the space needed for the downward board total displacement under load, like the potential interference of through-hole mount component pin tails of the board with a mechanical fixture on the back of the board.

NOTES:

1. The heatsink preload must remain below the maximum load limit of the package at all times (Refer to processor datasheet).
2. Board deflection should not exceed motherboard manufacturer specifications.



A.3.4.1 Motherboard Stiffening Considerations

To protect LGA775 socket solder joint, designers need to drive their mechanical design to:

- Allow downward board deflection to put the socket balls in a desirable force state to protect against fatigue failure of socket solder joint (refer to Sections A.3, A.3.1, and A.3.2).
- Prevent board upward bending during mechanical shock event.
- Define load paths that keep the dynamic load applied to the package within specifications published in the processor datasheet.

Limiting board deflection may be appropriate in some situations like:

- Board bending during shock
- Board creep with high heatsink preload

However, the load required to meet the board deflection recommendation (refer to Section A.3.2) with a very stiff board may lead to heatsink preloads exceeding package maximum load specification. For example, such a situation may occur when using a backing plate that is flush with the board in the socket area, and prevents the board to bend underneath the socket.

A.4 Heatsink Selection Guidelines

Evaluate carefully heatsinks coming with motherboard stiffening devices (like backing plates), and conduct board deflection assessments based on the board deflection metric.

Solutions derived from the reference design comply with the reference heatsink preload, for example:

- The Boxed Processor
- The reference design (E18764-001)

Intel will collaborate with vendors participating in its third party test house program to evaluate third party solutions. Vendor information now is available in Intel Core™2 Duo Processor Support Components webpage www.intel.com/go/thermal_Core2Duo .

§



Appendix B Heatsink Clip Load Metrology

B.1 Overview

This appendix describes a procedure for measuring the load applied by the heatsink/clip/fastener assembly on a processor package.

This procedure is recommended to verify the preload is within the design target range for a design, and in different situations. For example:

- Heatsink preload for the LGA775 socket
- Quantify preload degradation under bake conditions.

Note: This document reflects the current metrology used by Intel. Intel is continuously exploring new ways to improve metrology.

B.2 Test Preparation

B.2.1 Heatsink Preparation

Three load cells are assembled into the base of the heatsink under test, in the area interfacing with the processor Integrated Heat Spreader (IHS), using load cells equivalent to those listed in Section B.2.2.

To install the load cells, machine a pocket in the heatsink base, as shown in Figure 7-8 and Figure 7-9. The load cells should be distributed evenly, as close as possible to the pocket walls. Apply wax around the circumference of each load cell and the surface of the pocket around each cell to maintain the load cells in place during the heatsink installation on the processor and motherboard (Refer to Figure 7-9).

The depth of the pocket depends on the height of the load cell used for the test. It is necessary that the load cells protrude out of the heatsink base. However, this protrusion should be kept minimal, as it will create additional load by artificially raising the heatsink base. The measurement offset depends on the whole assembly stiffness (that is, motherboard, clip, fastener, and so forth). For example, the reference design clip and fasteners assembly stiffness is around 380 N/mm [2180 lb/in]. In that case, a protrusion of 0.038 mm [0.0015"] will create an extra load of 15 N [3.3 lb]. Figure 7-10 shows an example using the reference design.

Note: When optimizing the heatsink pocket depth, the variation of the load cell height should also be taken into account to make sure that all load cells protrude equally from the heatsink base. It may be useful to screen the load cells prior to installation to minimize variation.

Remarks: Alternate Heatsink Sample Preparation

As mentioned above, making sure that the load cells have minimum protrusion out of the heatsink base is paramount to meaningful results. An alternate method to make sure that the test setup will measure loads representative of the non-modified design is:

- Machine the pocket in the heat sink base to a depth such that the tips of the load cells are just flush with the heat sink base
- Then machine back the heatsink base by around 0.25 mm [0.01"], so that the load cell tips protrude beyond the base.

Proceeding this way, the original stack height of the heatsink assembly should be preserved. This should not affect the stiffness of the heatsink significantly.

Figure 7-8. Load Cell Installation in Machined Heatsink Base Pocket – Bottom View

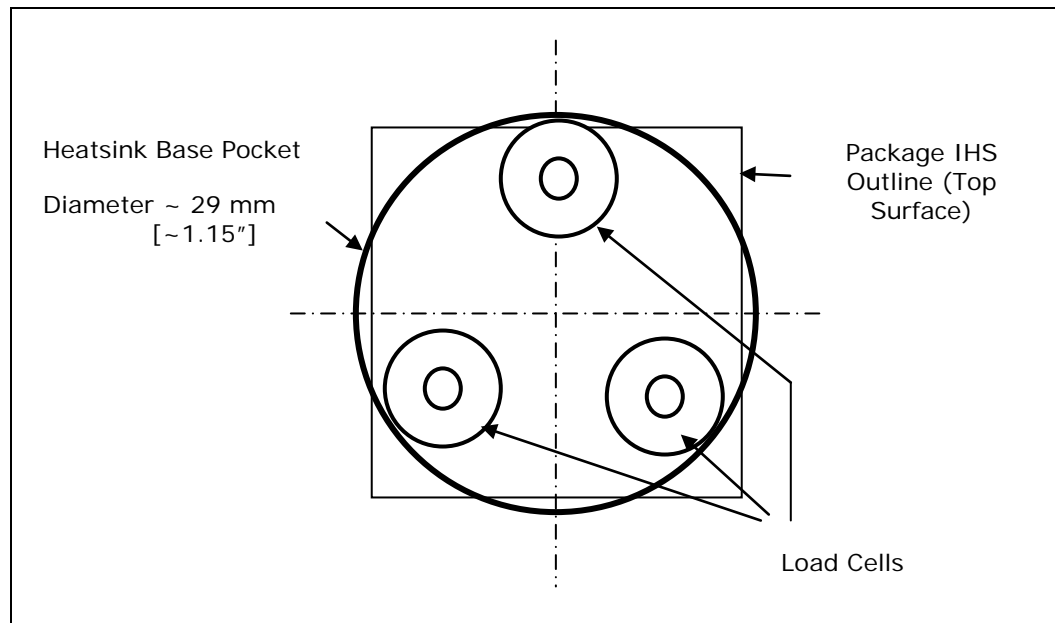




Figure 7-9. Load Cell Installation in Machined Heatsink Base Pocket – Side View

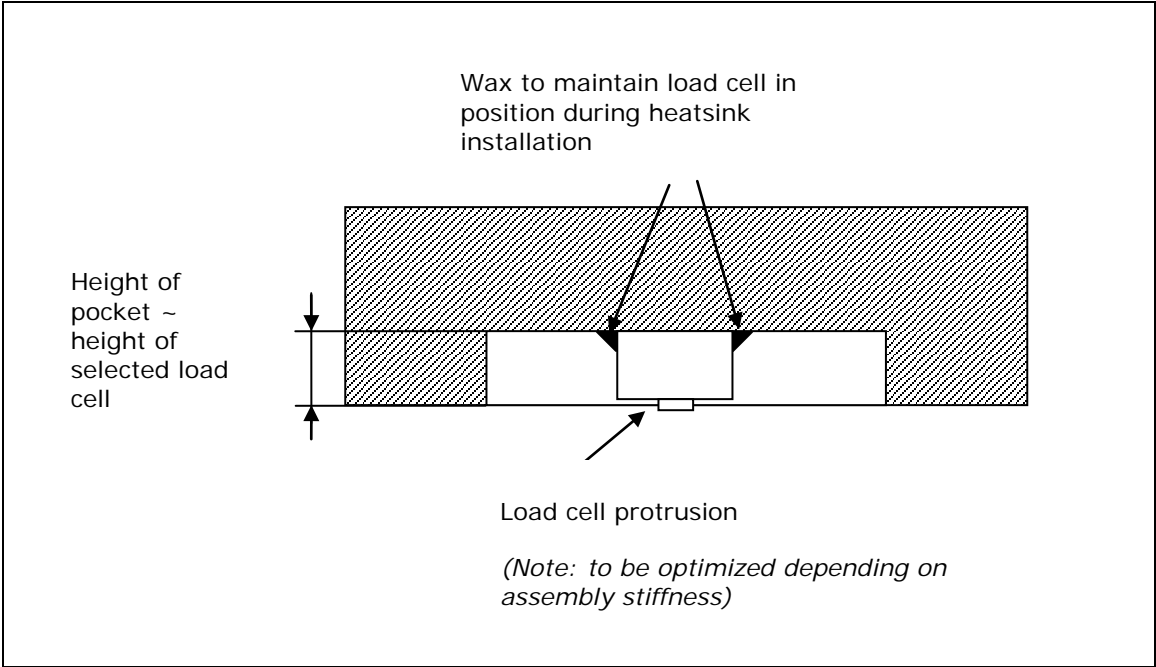
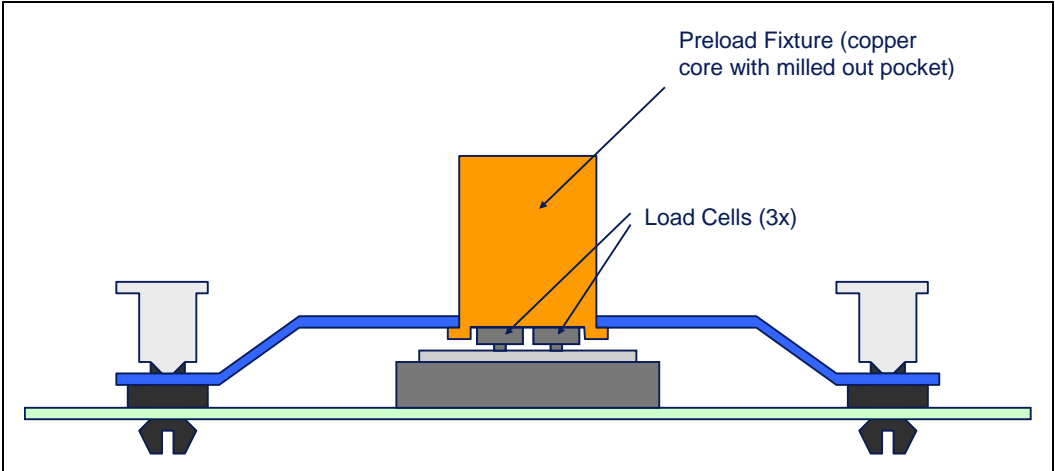


Figure 7-10. Preload Test Configuration





B.2.2 Typical Test Equipment

For the heatsink clip load measurement, use equivalent test equipment to the one listed in Table 7–2.

Table 7–2. Typical Test Equipment

Item	Description	Part Number (Model)
Load cell <i>Notes: 1, 5</i>	Honeywell*-Sensotec* Model 13 subminiature load cells, compression only Select a load range depending on load level being tested. www.sensotec.com	AL322BL
Data Logger (or scanner) <i>Notes: 2, 3, 4</i>	Vishay* Measurements Group Model 6100 scanner with a 6010A strain card (one card required per channel).	Model 6100

NOTES:

1. Select load range depending on expected load level. It is usually better, whenever possible, to operate in the high end of the load cell capability. Check with your load cell vendor for further information.
2. Since the load cells are calibrated in terms of mV/V, a data logger or scanner is required to supply 5 volts DC excitation and read the mV response. An automated model will take the sensitivity calibration of the load cells and convert the mV output into pounds.
3. With the test equipment listed above, it is possible to automate data recording and control with a 6101-PCI card (GPIB) added to the scanner, allowing it to be connected to a PC running LabVIEW* or Vishay's StrainSmart* software.
4. **IMPORTANT:** In addition to just a zeroing of the force reading at no applied load, it is important to calibrate the load cells against known loads. Load cells tend to drift. Contact your load cell vendor for calibration tools and procedure information.
5. When measuring loads under thermal stress (bake for example), load cell thermal capability must be checked, and the test setup must integrate any hardware used along with the load cell. For example, the Model 13 load cells are temperature compensated up to 71 °C, as long as the compensation package (spliced into the load cell's wiring) is also placed in the temperature chamber. The load cells can handle up to 121 °C (operating), but their uncertainty increases according to 0.02% rdg/°F.

B.3 Test Procedure Examples

The following sections provide two examples of load measurement. However, this is not meant to be used in mechanical shock and vibration testing.

Any mechanical device used along with the heatsink attach mechanism will need to be included in the test setup (that is, back plate, attach to chassis, and so forth).

Prior to any test, make sure that the load cell has been calibrated against known loads, following load cell vendor's instructions.



B.3.1 Time-Zero, Room Temperature Preload Measurement

1. Pre-assemble mechanical components on the board as needed prior to mounting the motherboard on an appropriate support fixture that replicate the board attach to a target chassis
 - For example: standard ATX board should sit on ATX compliant stand-offs. If the attach mechanism includes fixtures on the back side of the board, those must be included, as the goal of the test is to measure the load provided by the actual heatsink mechanism.
2. Install relevant test vehicle (TTV, processor) in the socket.
3. Assemble the heatsink reworked with the load cells to motherboard as shown for the reference design example in Figure 7-10, and actuate attach mechanism.
4. Collect continuous load cell data at 1 Hz for the duration of the test. A minimum time to allow the load cell to settle is generally specified by the load vendors (often of order of 3 minutes). The time zero reading should be taken at the end of this settling time.
5. Record the preload measurement (total from all three load cells) at the target time and average the values over 10 seconds around this target time as well, that is, in the interval , for example over [target time – 5 seconds ; target time +5 seconds].

B.3.2 Preload Degradation under Bake Conditions

This section describes an example of testing for potential clip load degradation under bake conditions.

1. Preheat thermal chamber to target temperature (45 °C or 85 °C for example)
2. Repeat time-zero, room temperature preload measurement
3. Place unit into preheated thermal chamber for specified time
4. Record continuous load cell data as follows:
 - Sample rate = 0.1 Hz for first 3 hrs
 - Sample rate = 0.01 Hz for the remainder of the bake test
5. Remove assembly from thermal chamber and set into room temperature conditions
6. Record continuous load cell data for next 30 minutes at sample rate of 1 Hz.

S





Appendix C Thermal Interface Management

To optimize a heatsink design, it is important to understand the impact of factors related to the interface between the processor and the heatsink base. Specifically, the bond line thickness, interface material area, and interface material thermal conductivity should be managed to realize the most effective thermal solution.

C.1 Bond Line Management

Any gap between the processor integrated heat spreader (IHS) and the heatsink base degrades thermal solution performance. The larger the gap between the two surfaces, the greater the thermal resistance. The thickness of the gap is determined by the flatness and roughness of both the heatsink base and the integrated heat spreader, plus the thickness of the thermal interface material (for example thermal grease) used between these two surfaces and the clamping force applied by the heatsink attach clip(s).

C.2 Interface Material Area

The size of the contact area between the processor and the heatsink base will impact the thermal resistance. There is, however, a point of diminishing returns. Unrestrained incremental increases in thermal interface material area do not translate to a measurable improvement in thermal performance.

C.3 Interface Material Performance

Two factors impact the performance of the interface material between the processor and the heatsink base:

- Thermal resistance of the material
- Wetting/filling characteristics of the material

Thermal resistance is a description of the ability of the thermal interface material to transfer heat from one surface to another. The higher the thermal resistance, the less efficient the interface material is at transferring heat. The thermal resistance of the interface material has a significant impact on the thermal performance of the overall thermal solution. The higher the thermal resistance, the larger the temperature drop is across the interface and the more efficient the thermal solution (heatsink, fan) must be to achieve the desired cooling.

The wetting or filling characteristic of the thermal interface material is its ability, under the load applied by the heatsink retention mechanism, to spread and fill the gap between the processor and the heatsink. Since air is an extremely poor thermal conductor, the more completely the interface material fills the gaps, the lower the temperature drops across the interface. In this case, thermal interface material area also becomes significant; the larger the desired thermal interface material area, the higher the force required to spread the thermal interface material.



§



Appendix D Case Temperature Reference Metrology

D.1 Objective and Scope

This appendix defines a reference procedure for attaching a thermocouple to the IHS of a 775-land LGA package for T_c measurement. This procedure takes into account the specific features of the 775-land LGA package and of the LGA775 socket for which it is intended. The recommended equipment for the reference thermocouple installation, including tools and part numbers are also provided. In addition a video *Thermocouple Attach Using Solder – Video CD-ROM* is available that shows the process in real time.

The following supplier can do machining the groove and attaching a thermocouple to the IHS followed by the reference procedure. The supplier is listed the table below as a convenience to Intel's general customers and the list may be subject to change without notice.

Supplier	Contact	Phone	Email	Address
THERM-X OF CALIFORNIA	Ernesto B Valencia	510-441-7566 Ext. 242	ernestov@therm-x.com	1837 Whipple Road, Hayward, Ca 94544

D.2 Supporting Test Equipment

To apply the reference thermocouple attach procedure, it is recommended to use the equipment (or equivalent) given in the table below.

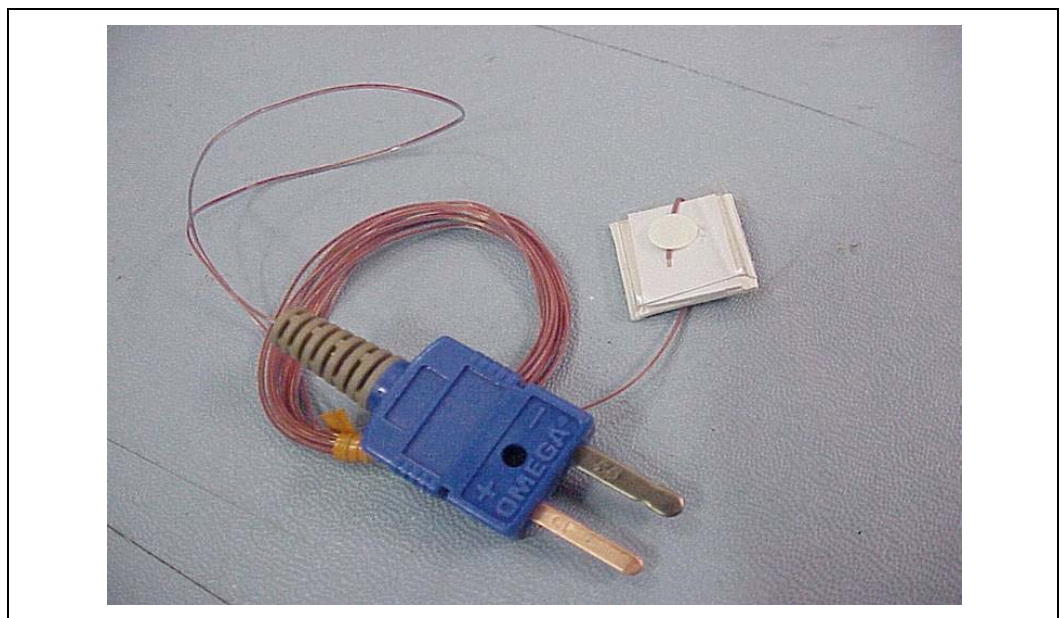
Item	Description	Part Number
Measurement and Output		
Microscope	Olympus* Light microscope or equivalent	SZ-40
DMM	Digital Multi Meter for resistance measurement	Fluke 79 Series
Thermal Meter	Hand held thermocouple meter	Multiple Vendors
Solder Station (see note 1 for ordering information)		
Heater Block	Heater assembly to reflow solder on IHS	30330
Heater	WATLOW120V 150W Firerod	0212G G1A38-L12
Transformer	Superior Powerstat transformer	05F857

Item	Description	Part Number
Miscellaneous Hardware		
Solder	Indium Corp. of America Alloy 57BI / 42SN / 1AG 0.010 Diameter	52124
Flux	Indium Corp. of America	5RMA
Loctite* 498 Adhesive	Super glue w/thermal characteristics	49850
Adhesive Accelerator	Loctite* 7452 for fast glue curing	18490
Kapton* Tape	For holding thermocouple in place	Not Available
Thermocouple	Omega *,.36 gauge, "T" Type (see note 2 for ordering information)	OSK2K1280/5SR TC-TT-T-36-72
Calibration and Control		
Ice Point Cell	Omega*, stable 0 °C temperature source for calibration and offset	TRCIII
Hot Point Cell	Omega *, temperature source to control and understand meter slope gain	CL950-A-110

NOTES:

1. The Solder Station consisting of the Heater Block, Heater, Press and Transformer are available from Jemelco Engineering 480-804-9514
2. This part number is a custom part with the specified insulation trimming and packaging requirements necessary for quality thermocouple attachment, See Figure 7-11. Order from Omega Anthony Alvarez, Direct phone (203) 359-7671, Direct fax (203) 968-7142, E-Mail: aalvarez@omega.com

Figure 7-11. Omega Thermocouple





D.3 Thermal Calibration and Controls

It is recommended that full and routine calibration of temperature measurement equipment be performed before attempting to perform temperature case measurement. Intel recommends checking the meter probe set against known standards. This should be done at 0° C (using ice bath or other stable temperature source) and at an elevated temperature, around 80° C (using an appropriate temperature source).

Wire gauge and length also should be considered as some less expensive measurement systems are heavily impacted by impedance. There are numerous resources available throughout the industry to assist with implementation of proper controls for thermal measurements.

NOTES:

1. It is recommended to follow company standard procedures and wear safety items like glasses for cutting the IHS and gloves for chemical handling.
2. Ask your Intel field sales representative if you need assistance to groove and/or install a thermocouple according to the reference process.

D.4 IHS Groove

Cut a groove in the package IHS; see the drawings given in Figure 7-12 and Figure 7-13. The groove orientation in Figure 7-12 is toward the IHS notch to allow the thermocouple wire to be routed under the socket lid. This will protect the thermocouple from getting damaged or pinched when removing and installing the heatsink (see Figure 7-37).

Figure 7-12. 775-LAND LGA Package Reference Groove Drawing at 6 o'clock Exit

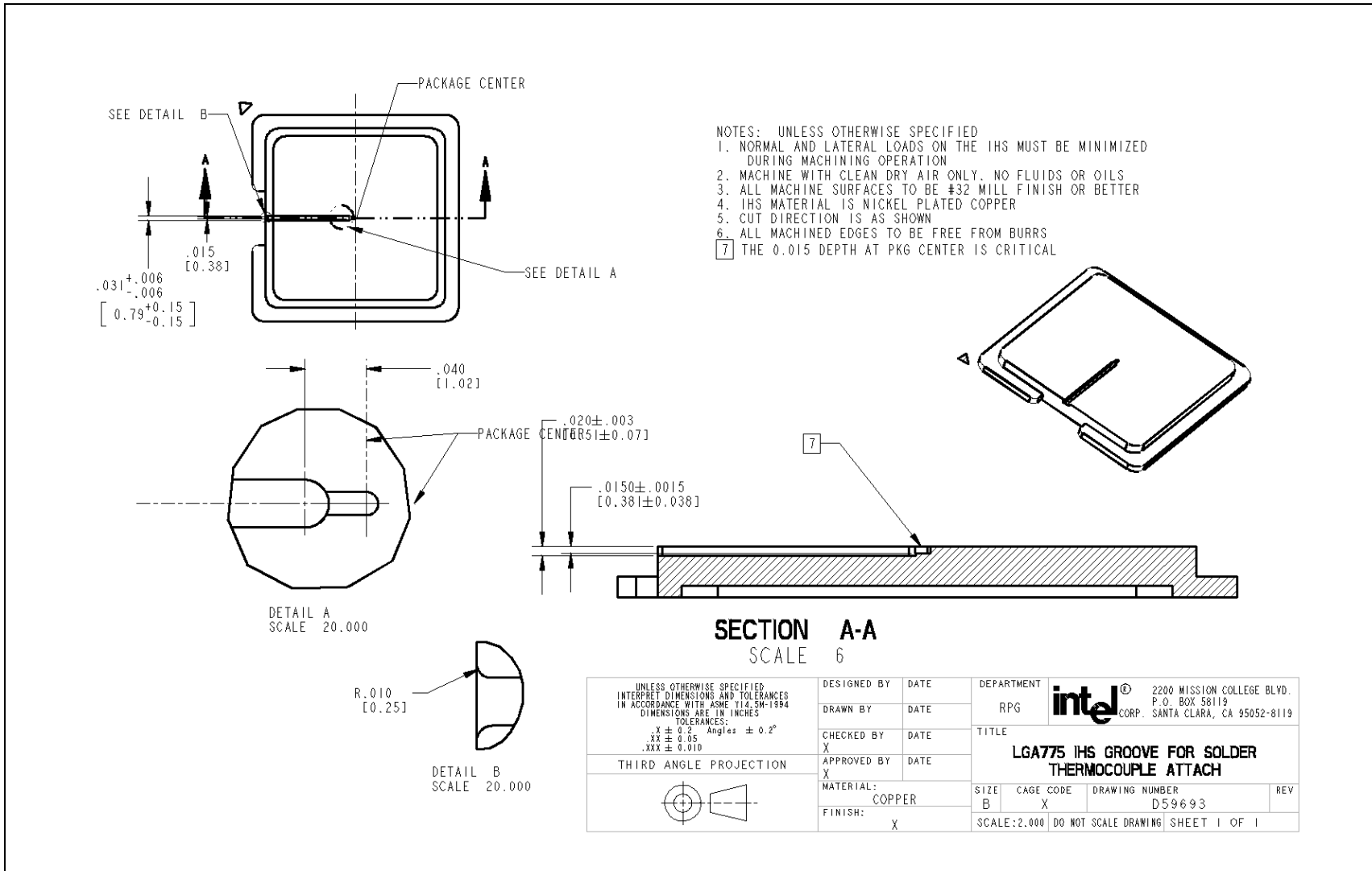
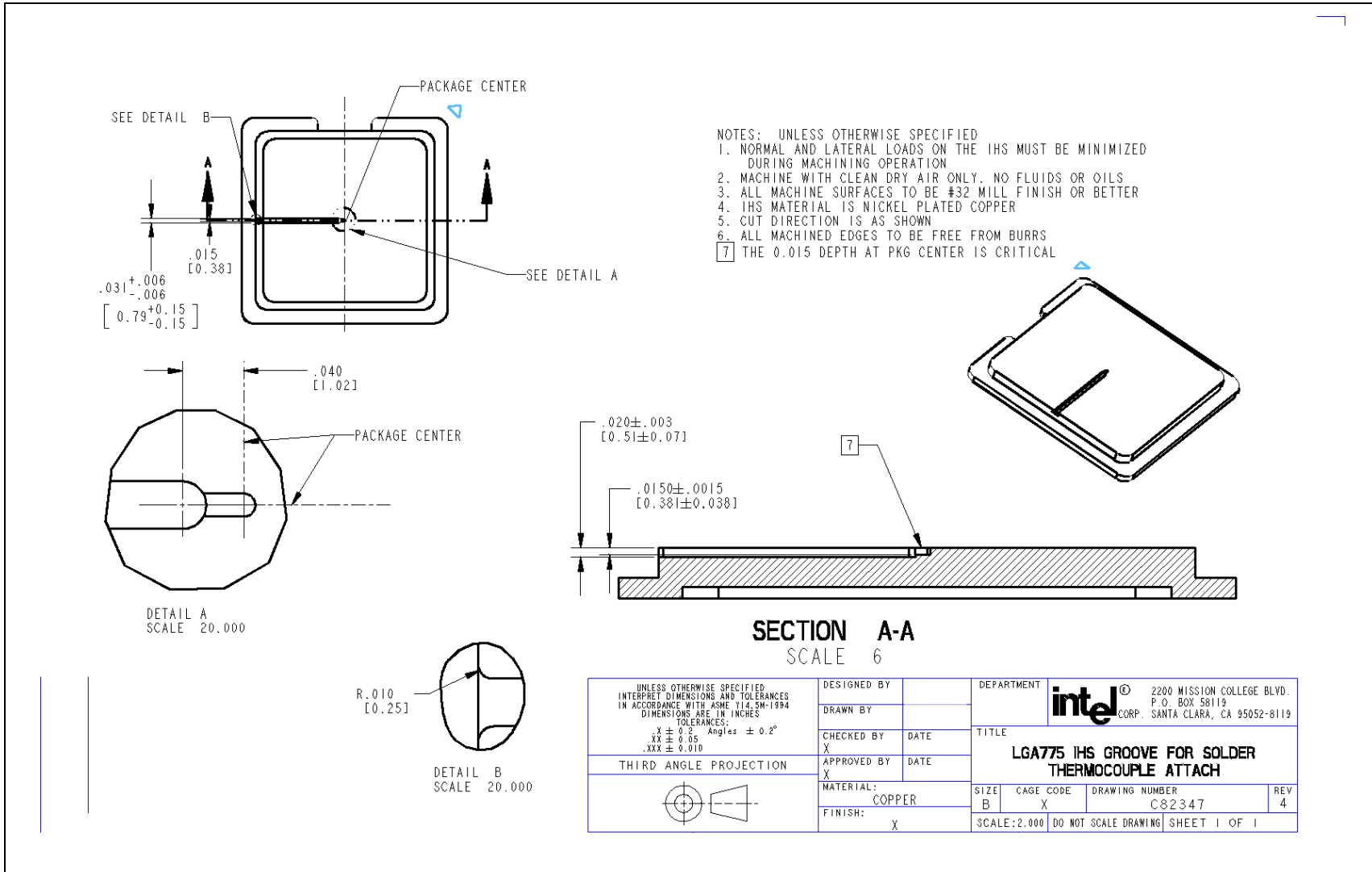


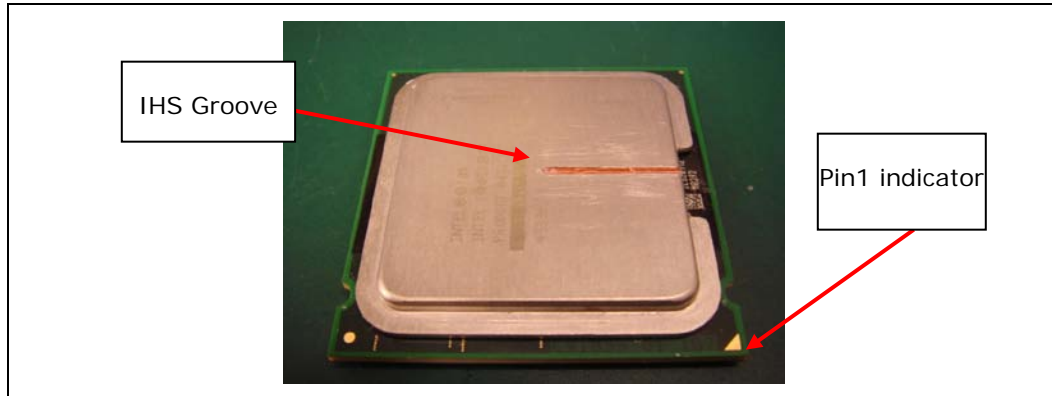


Figure 7-13. 775-LAND LGA Package Reference Groove Drawing at 3 o'clock Exit (Old Drawing)



The orientation of the groove at 6 o'clock exit relative to the package pin 1 indicator (gold triangle in one corner of the package) is shown in Figure 7-14 for the 775-Land LGA package IHS.

Figure 7-14. IHS Groove at 6 o'clock Exit on the 775-LAND LGA Package



When the processor is installed in the LGA775 socket, the groove is parallel to the socket load lever, and is toward the IHS notch as shown Figure 7-15.

Figure 7-15. IHS Groove at 6 o'clock Exit Orientation Relative to the LGA775 Socket



Select a machine shop that is capable of holding drawing specified tolerances. IHS groove geometry is critical for repeatable placement of the thermocouple bead, ensuring precise thermal measurements. The specified dimensions minimize the impact of the groove on the IHS under the socket load. A larger groove may cause the IHS to warp under the socket load such that it does not represent the performance of an ungrooved IHS on production packages.

Inspect parts for compliance to specifications before accepting from machine shop.



D.5 Thermocouple Attach Procedure

The procedure to attach a thermocouple with solder takes about 15 minutes to complete. Before proceeding turn on the solder block heater, as it can take up to 30 minutes to reach the target temperature of 153 – 155 °C.

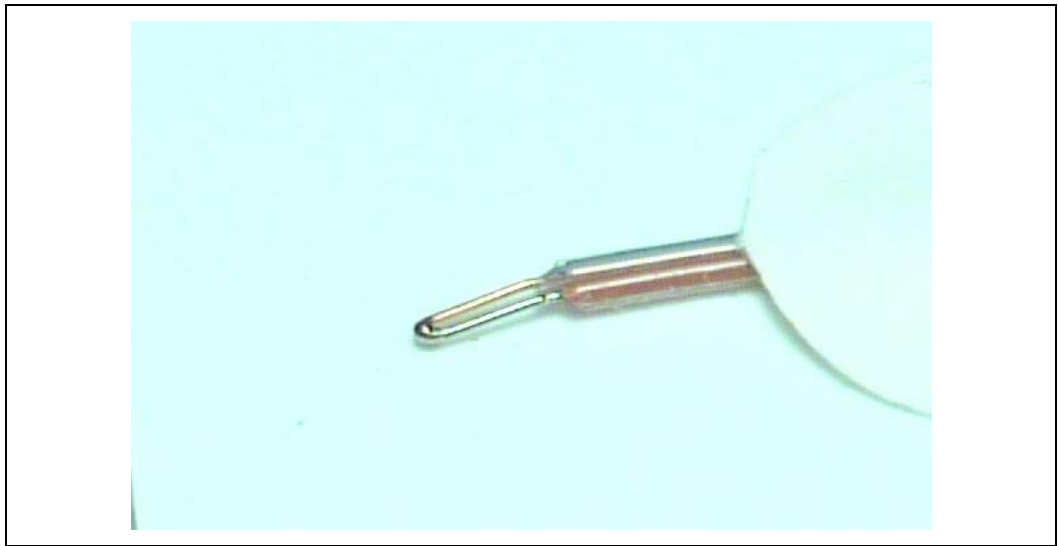
Note: To avoid damage to the processor ensure the IHS temperature does not exceed 155 °C.

As a complement to the written procedure a video *Thermocouple Attach Using Solder* – Video CD-ROM is available.

D.5.1 Thermocouple Conditioning and Preparation

1. Use a calibrated thermocouple as specified in Sections D.2 and D.3.
2. Under a microscope verify the thermocouple insulation meets the quality requirements. The insulation should be about 1/16 inch (0.062 ± 0.030) from the end of the bead (Figure 7-16).

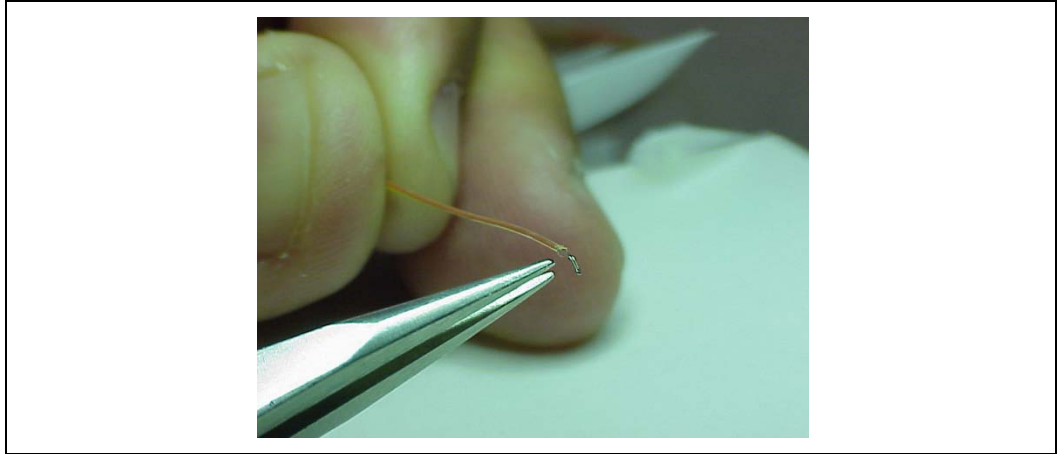
Figure 7-16. Inspection of Insulation on Thermocouple



3. Measure the thermocouple resistance by holding both contacts on the connector on one probe and the tip of thermocouple to the other probe of the DMM (measurement should be about ~3.0 ohms for 36-gauge type T thermocouple).
4. Straighten the wire for about 38 mm [1 ½ inch] from the bead.

5. Using the microscope and tweezers, bend the tip of the thermocouple at approximately 10 degree angle by about 0.8 mm [.030 inch] from the tip (Figure 7-17).

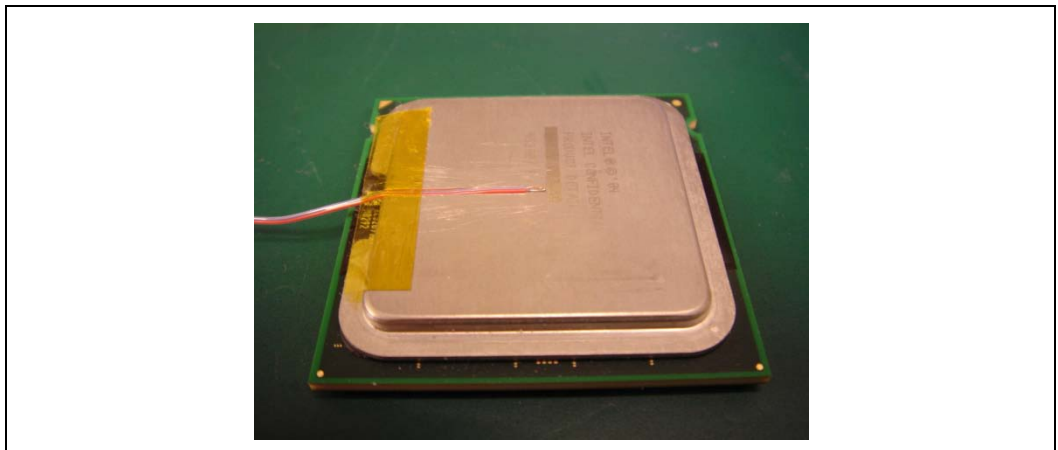
Figure 7-17. Bending the Tip of the Thermocouple



D.5.2 Thermocouple Attachment to the IHS

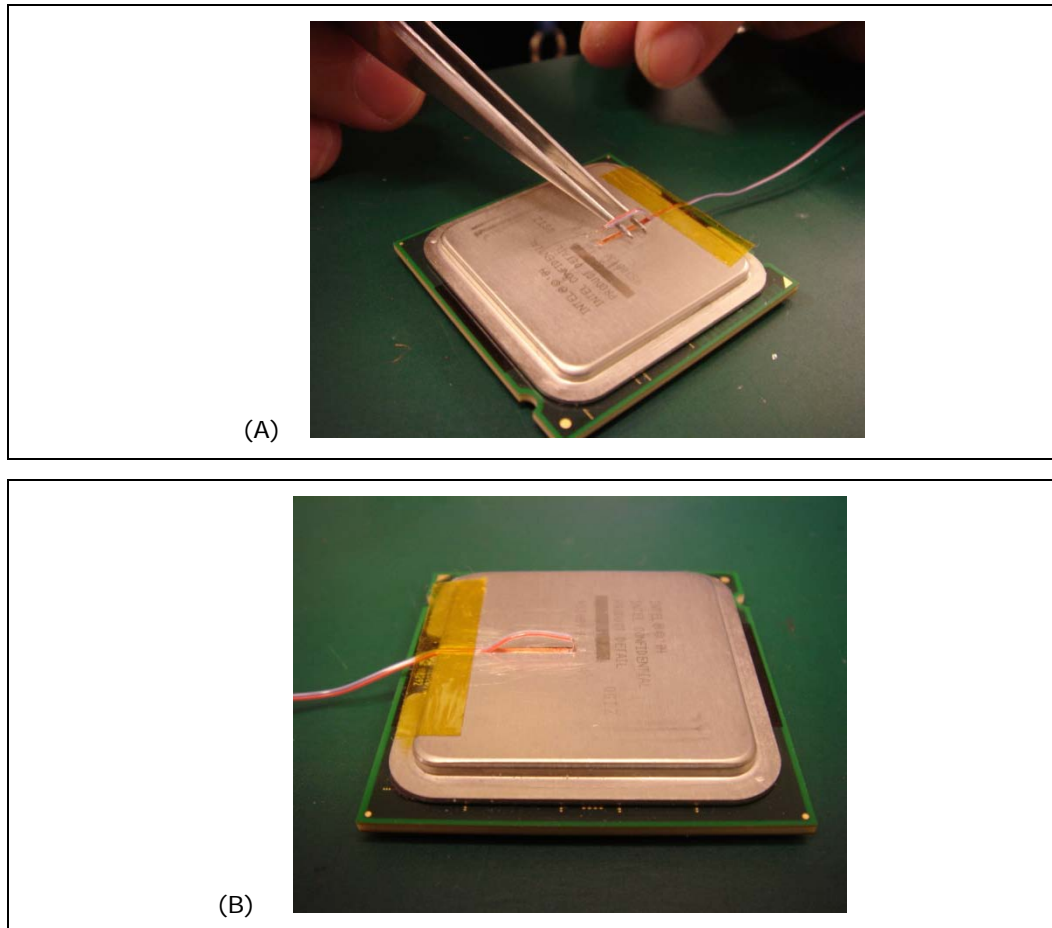
6. Clean groove and IHS with Isopropyl Alcohol (IPA) and a lint free cloth removing all residues prior to thermocouple attachment.
7. Place the thermocouple wire inside the groove; letting the exposed wire and bead extend about 1.5 mm [0.030 inch] past the end of groove. Secure it with Kapton* tape (Figure 7-18). Clean the IHS with a swab and IPA.
8. Verify under the microscope that the thermocouple wires are straight and parallel in the groove and that the bead is still bent.

Figure 7-18. Securing Thermocouple Wires with Kapton* Tape Prior to Attach



9. Lift the wire at the middle of groove with tweezers and bend the front of wire to place the thermocouple in the groove ensuring the tip is in contact with the end and bottom of the groove in the IHS (Figure 7-19-A and B).

Figure 7-19. Thermocouple Bead Placement



10. Place the package under the microscope to continue with process. It is also recommended to use a fixture (like processor tray or a plate) to help holding the unit in place for the rest of the attach process.

11. While still at the microscope, press the wire down about 6mm [0.125"] from the thermocouple bead using the tweezers or your finger. Place a piece of Kapton* tape to hold the wire inside the groove (Figure 7-20). Refer to Figure 7-21 for detailed bead placement.

Figure 7-20. Position Bead on the Groove Step

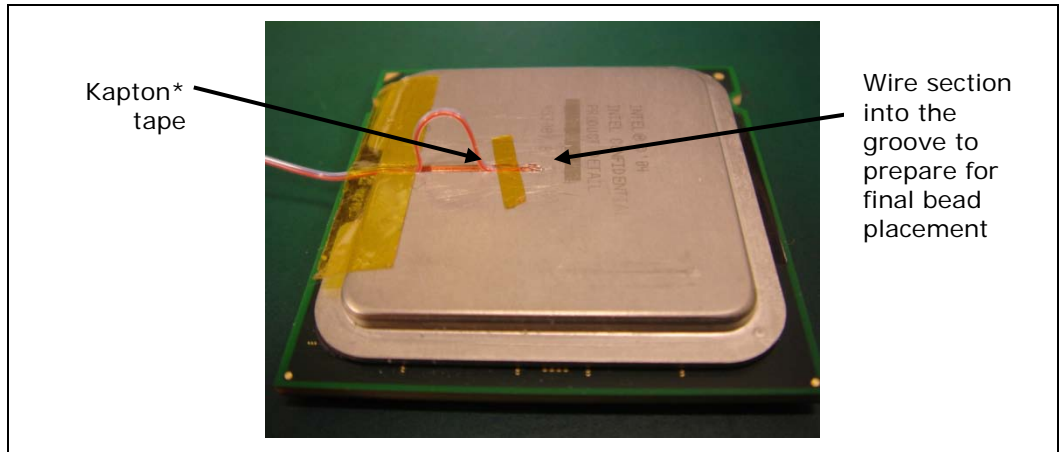


Figure 7-21. Detailed Thermocouple Bead Placement

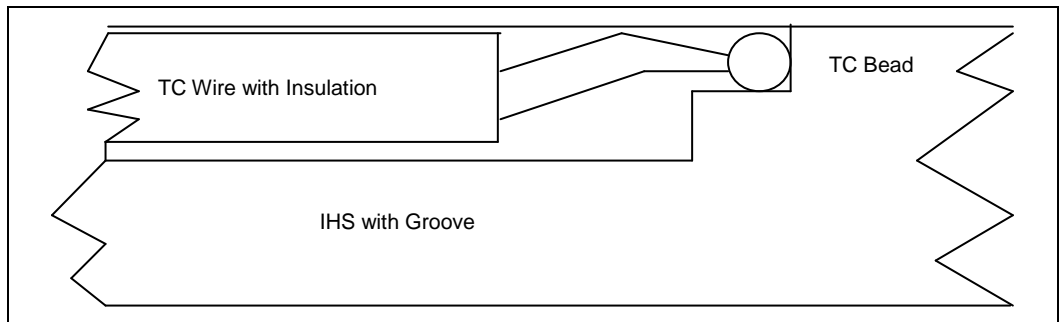
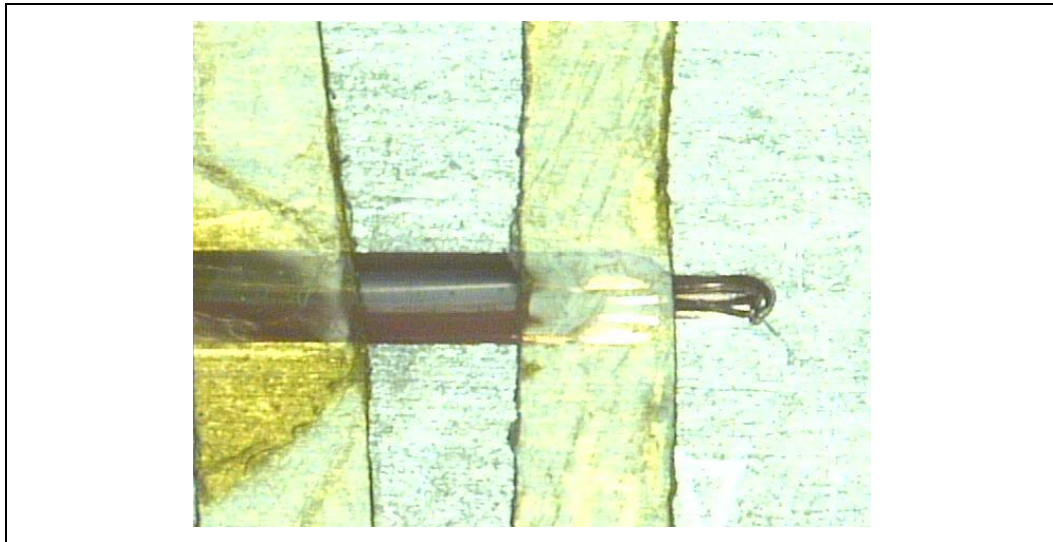
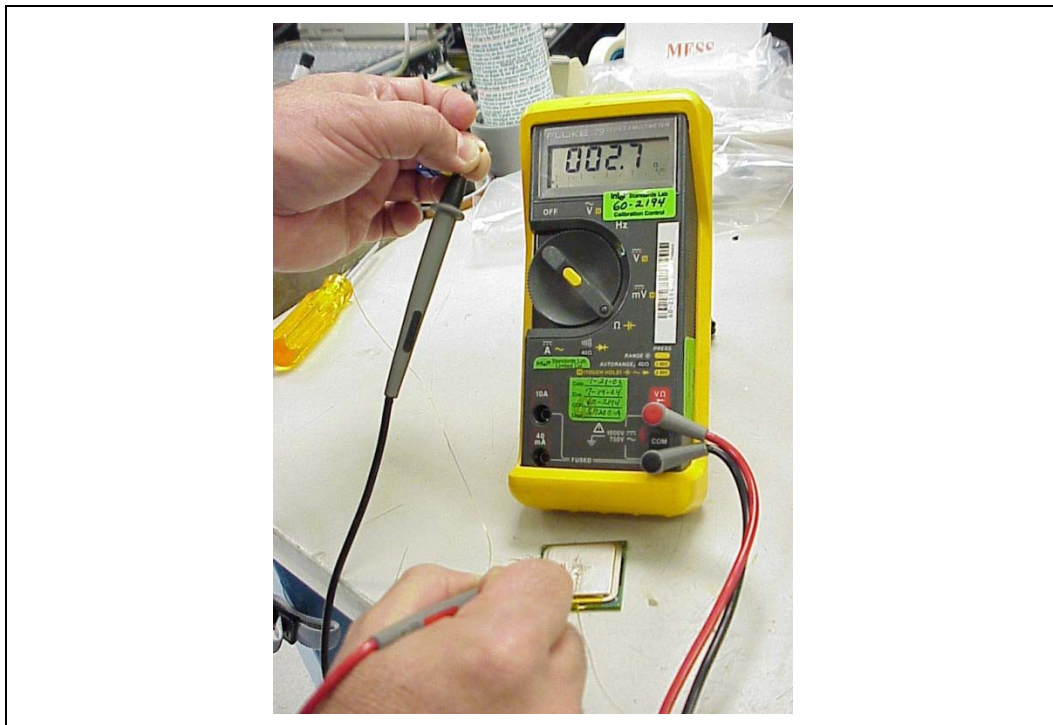


Figure 7-22. Third Tape Installation



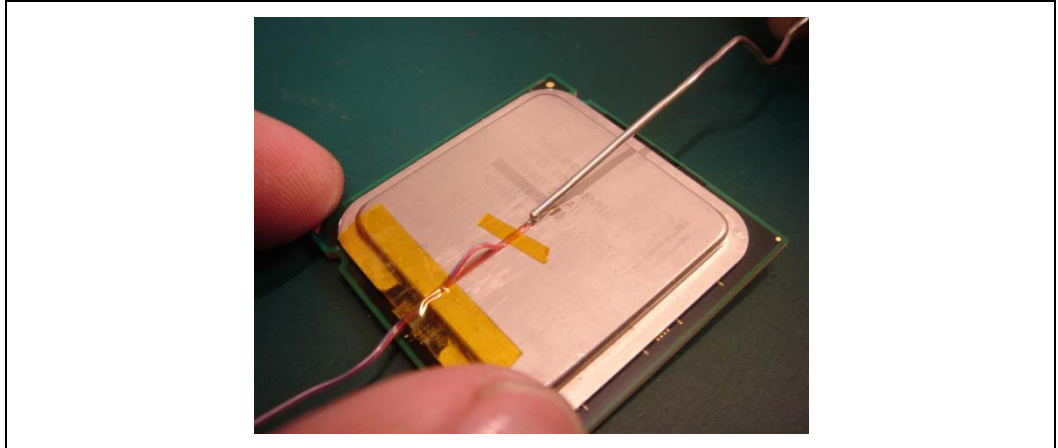
12. Place a 3rd piece of tape at the end of the step in the groove as shown in Figure 7-22. This tape will create a solder dam to prevent solder from flowing into the larger IHS groove section during the melting process.
13. Measure resistance from thermocouple end wires (hold both wires to a DMM probe) to the IHS surface. This should be the same value as measured during the thermocouple conditioning Section D.5.1.step 3 (Figure 7-23).

Figure 7-23. Measuring Resistance between Thermocouple and IHS



14. Using a fine point device, place a small amount of flux on the thermocouple bead. Be careful not to move the thermocouple bead during this step (Figure 7-24). Ensure the flux remains in the bead area only.

Figure 7-24. Applying Flux to the Thermocouple Bead



15. Cut two small pieces of solder 1/16 inch (0.065 inch / 1.5 mm) from the roll using tweezers to hold the solder while cutting with a fine blade (Figure 7-25).

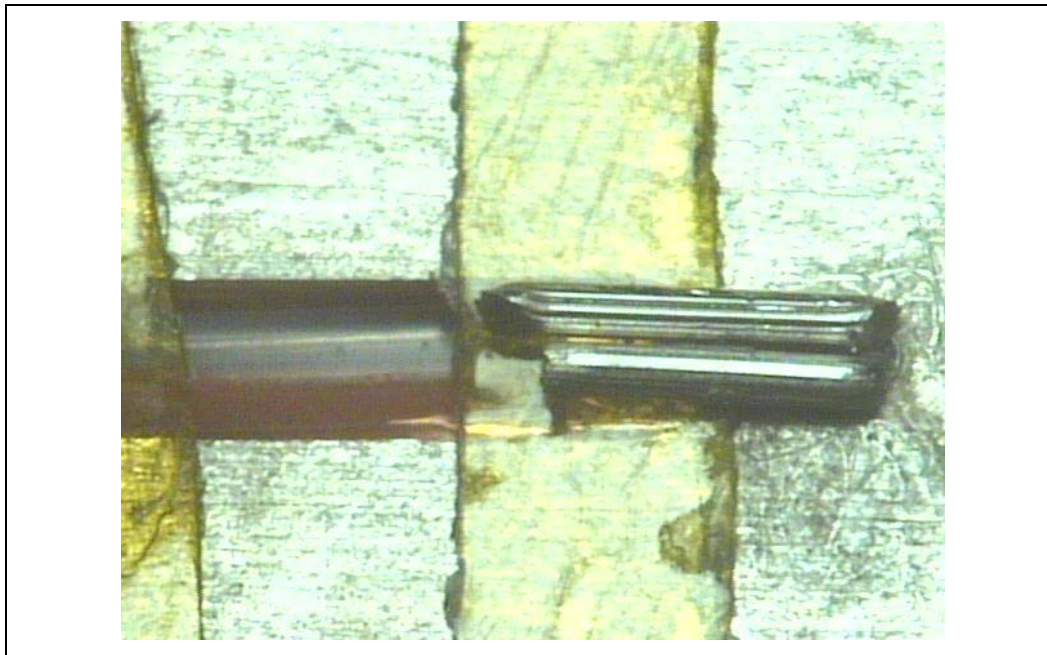
Figure 7-25. Cutting Solder





16. Place the two pieces of solder in parallel, directly over the thermocouple bead (Figure 7-26).

Figure 7-26. Positioning Solder on IHS



17. Measure the resistance from the thermocouple end wires again using the DMM (refer to Section D.5.1.step 2) to ensure the bead is still properly contacting the IHS.

D.5.3 Solder Process

18. Make sure the thermocouple that monitors the Solder Block temperature is positioned on the Heater block. Connect the thermocouple to a handheld meter to monitor the heater block temperature
19. Verify the temperature of the Heater block station has reached $155\text{ }^{\circ}\text{C} \pm 5\text{ }^{\circ}\text{C}$ before you proceed.
20. Connect the thermocouple for the device being soldered to a second hand held meter to monitor IHS temperature during the solder process.

Figure 7-27. Solder Station Setup



21. Remove the land side protective cover and place the device to be soldered in the solder station. Make sure the thermocouple wire for the device being soldered is exiting the heater toward you.

Note: Do **not** touch the copper heater block at any time as this is very hot.

22. Move a magnified lens light close to the device in the solder status to get a better view when the solder begins to melt.
23. Lower the Heater block onto the IHS. Monitor the device IHS temperature during this step to ensure the maximum IHS temperature is not exceeded.

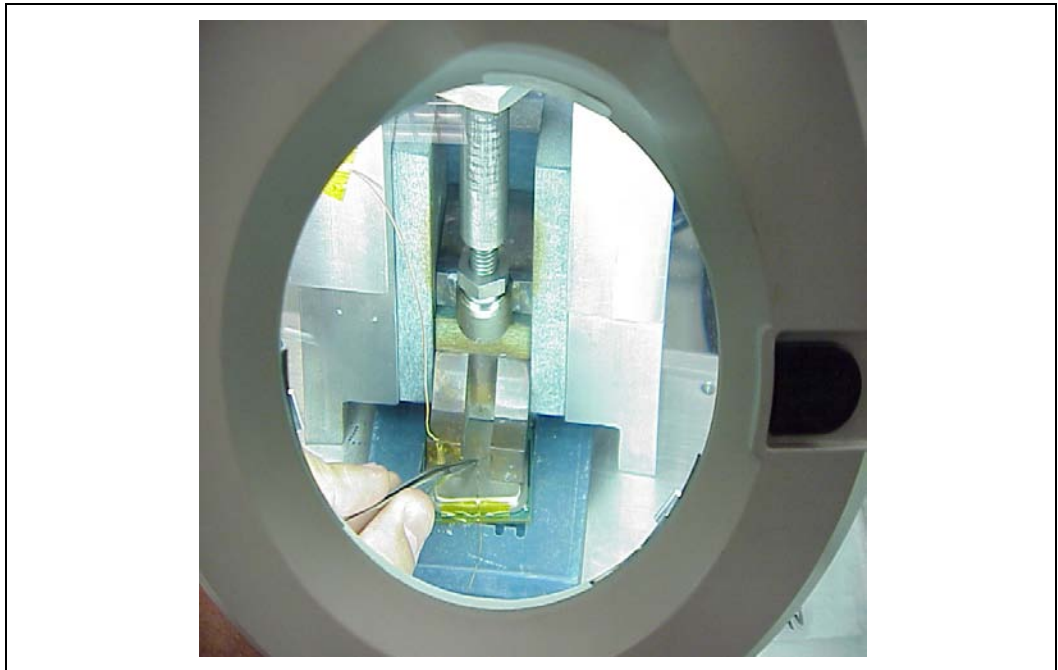
Note: The target IHS temperature during reflow is $150\text{ }^{\circ}\text{C} \pm 3\text{ }^{\circ}\text{C}$. At no time should the IHS temperature exceed $155\text{ }^{\circ}\text{C}$ during the solder process as damage to the device may occur.

24. You may need to move the solder back toward the groove as the IHS begins to heat. Use a fine tip tweezers to push the solder into the end of the groove until a solder ball is built up (Figure 7-28 and Figure 7-29).

Figure 7-28. View Through Lens at Solder Station

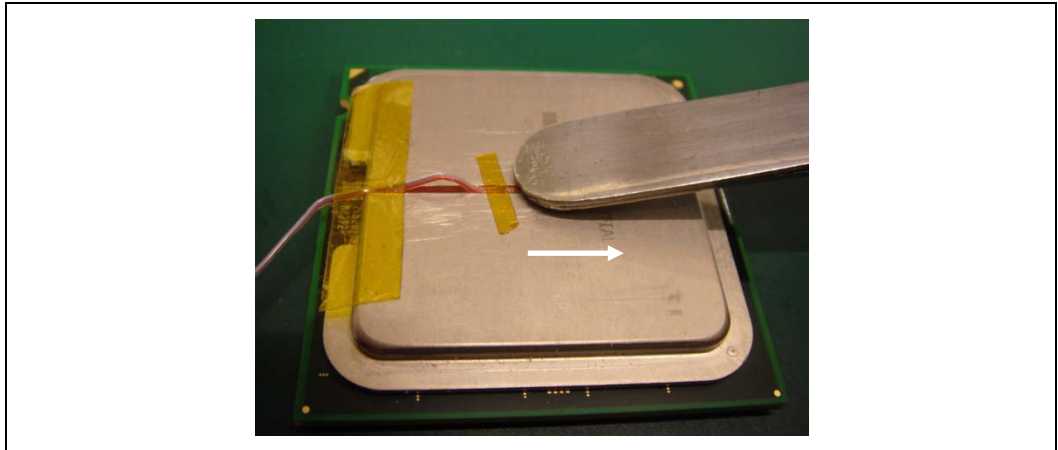


Figure 7-29. Moving Solder back onto Thermocouple Bead



25. Lift the heater block and magnified lens, using tweezers quickly rotate the device 90 degrees clockwise. Using the back of the tweezers press down on the solder this will force out the excess solder.

Figure 7-30. Removing Excess Solder



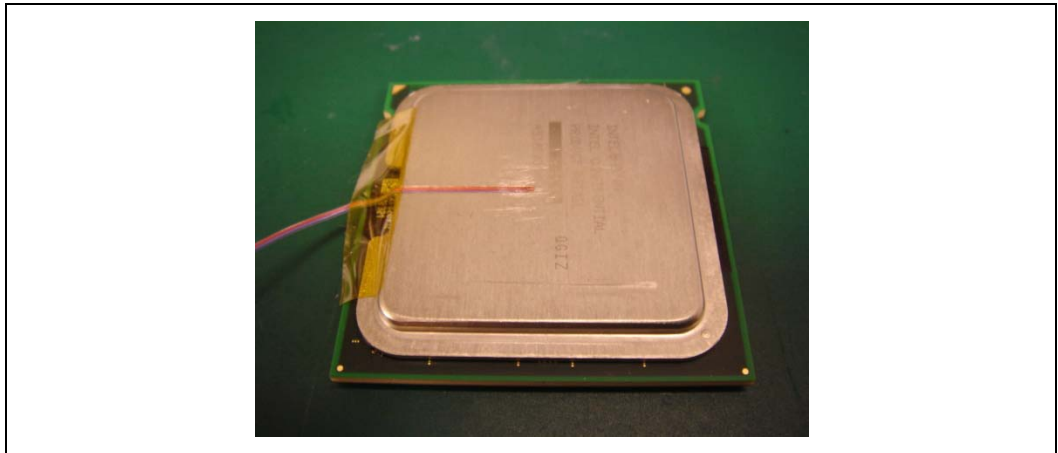
26. Allow the device to cool down. Blowing compressed air on the device can accelerate the cooling time. Monitor the device IHS temperature with a handheld meter until it drops below 50 °C before moving it to the microscope for the final steps.

D.5.4 Cleaning and Completion of Thermocouple Installation

27. Remove the device from the solder station and continue to monitor IHS Temperature with a handheld meter. Place the device under the microscope and remove the three pieces of Kapton* tape with Tweezers, keeping the longest for re-use.
28. Straighten the wire and work the wire in to the groove. Bend the thermocouple over the IHS. Replace the long piece of Kapton* tape at the edge of the IHS.

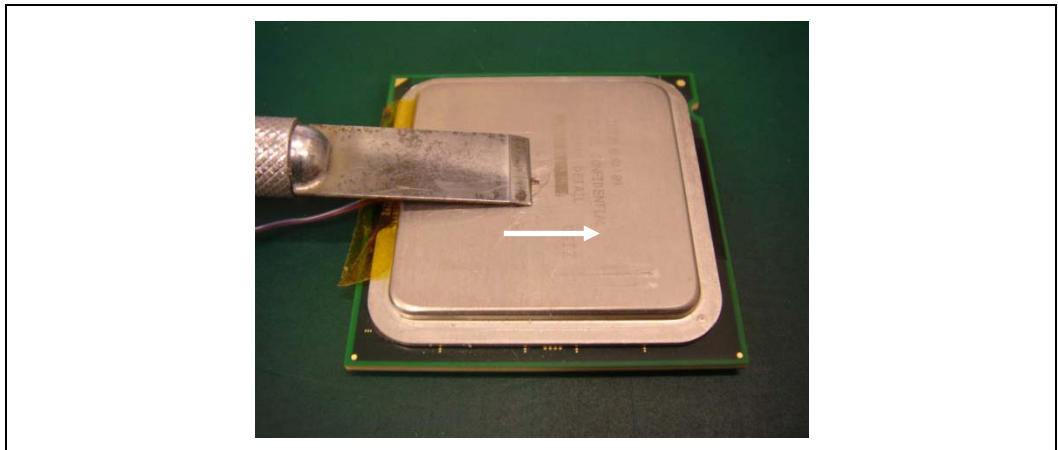
Note: The wire needs to be straight so it doesn't sit above the IHS surface at anytime (Figure 7-31).

Figure 7-31. Thermocouple placed into groove



29. Using a blade carefully shave the excess solder above the IHS surface. Only shave in one direction until solder is flush with the groove surface (Figure 7-32).

Figure 7-32. Removing Excess Solder

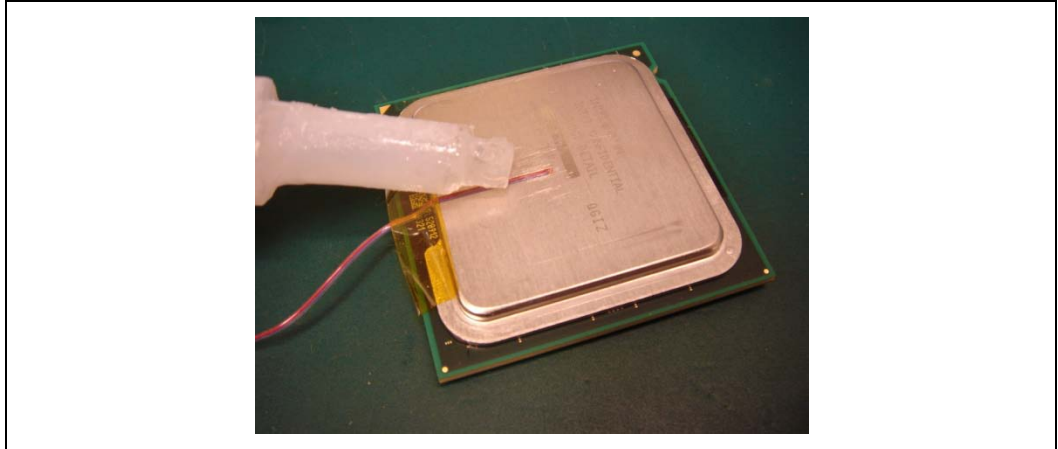


Note: Take usual precautions when using open blades

30. Clean the surface of the IHS with Alcohol and use compressed air to remove any remaining contaminants.

31. Fill the rest of the groove with Loctite* 498 Adhesive. Verify under the microscope that the thermocouple wire is below the surface along the entire length of the IHS groove (Figure 7-33).

Figure 7-33. Filling Groove with Adhesive



32. To speed up the curing process apply Loctite* Accelerator on top of the Adhesive and let it set for a couple of minutes (Figure 7-34).

Figure 7-34. Application of Accelerant

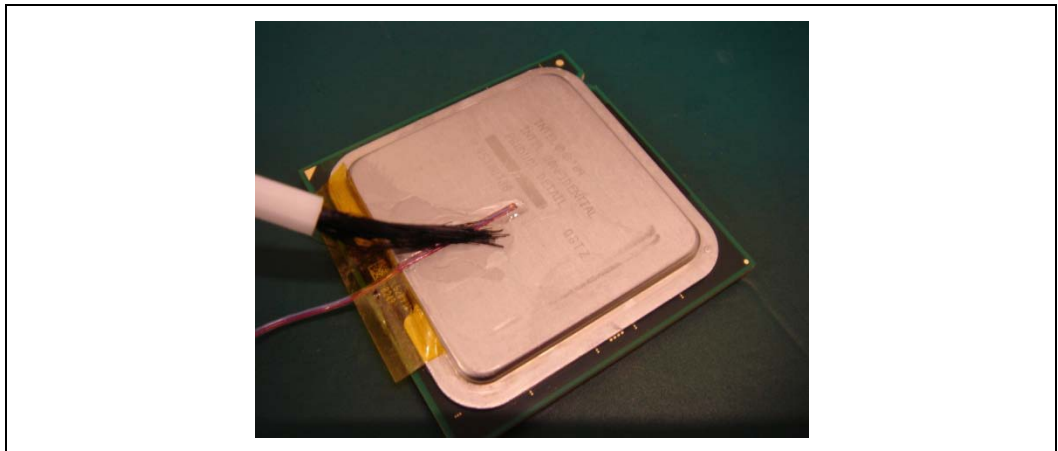


Figure 7-35. Removing Excess Adhesive from IHS

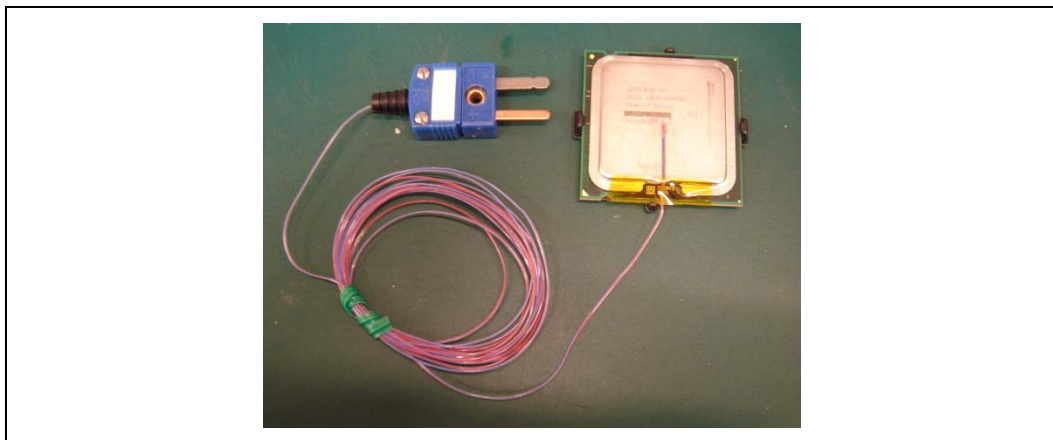


33. Using a blade, carefully shave any adhesive that is above the IHS surface (Figure 7-35). The preferred method is to shave from the edge to the center of the IHS.

Note: The adhesive shaving step should be performed while the adhesive is partially cured, but still soft. This will help to keep the adhesive surface flat and smooth with no pits or voids. If there are voids in the adhesive, refill the voids with adhesive and shave a second time.

34. Clean IHS surface with IPA and a wipe.
35. Clean the LGA pads with IPA and a wipe.
36. Replace the land side cover on the device.
37. Perform a final continuity test.
38. Wind the thermocouple wire into loops and secure or if provided by the vendor back onto the plastic roll. (Figure 7-36).

Figure 7-36. Finished Thermocouple Installation



39. Place the device in a tray or bag until it's ready to be used for thermal testing use.

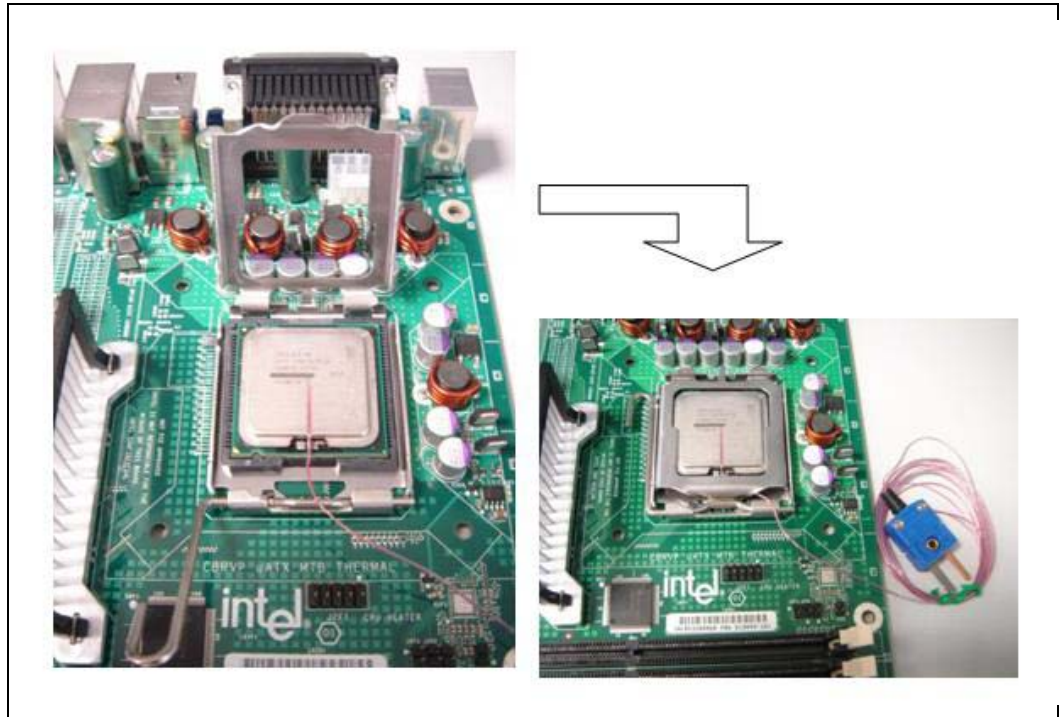
D.6 Thermocouple Wire Management

When installing the processor into the socket, the thermocouple wire should route under the socket lid, as Figure 7-37. This will keep the wire from getting damaged or pinched when removing and installing the heatsink.

Note: When thermocouple wires are damaged, the resulting reading maybe wrong. For example, if there are any cuts into the wires insulation where the wires are pinched between the heatsink and the socket lid when installing the heatsink, the thermocouple wires can get in contact at this location. In that case, the reported temperature would be the point of the heatsink/socket lid area. This temperature is usually much lower than the temperature at the center of the IHS.

Prior to installing the heatsink, make sure that the thermocouple wires remain below the IHS top surface, by running a flat blade on top of the IHS for example.

Figure 7-37. Thermocouple Wire Management



S



Appendix E Balanced Technology Extended (BTX) System Thermal Considerations

There are anticipated system operating conditions in which the processor power may be low but other system component powers may be high. If the only Fan Speed Control (FSC) circuit input for the Thermal Module Assembly (TMA) fan is from the processor sensor then the fan speed and system airflow is likely to be too low in this operating state. Therefore, it is recommended that a second FSC circuit input be acquired from an ambient temperature monitor location within the system.

The location of the System Monitor thermal sensor is best determined through extensive system-level numerical thermal modeling or prototype thermal testing. In either case, the temperature of critical components or the air temperature near critical components should be assessed for a range of system external temperatures, component powers, and fan speed operating conditions. The temperature at the selected location for the System Monitor Point should be well correlated to the temperatures at or near critical components. For instance, it may be useful to monitor the temperature near the PSU airflow inlet, near the graphics add-in card, or near memory.

The final system integrator is typically responsible for ensuring compliance with the component temperature specifications at all operating conditions and, therefore, should be responsible for specifying the System Monitor thermal sensor location. However, it is not always possible for a board supplier – especially a channel board supplier – to know the system into which a board will be installed. It is therefore important for BTX board suppliers to select a System Monitor thermal sensor location that will function properly in most systems.

A BTX system should be designed such that the TMA exhaust is the primary airflow stream that cools the rest of the system. The airflow passes through the chipset heatsink and its temperature will rise as the memory controller chipset power increases. Since chipset power will increase when other subsystems (such as, memory, graphics) are active, a System Monitor thermal sensor located in the exhaust airflow from the chipset heatsink is a reasonable location.

It is likely that a thermal sensor that is not mounted above the board and in the chipset exhaust airflow will reflect board temperature and not ambient temperature. It is therefore recommended that the Thermal sensor be elevated above the board.



The thermal sensor location and elevation are reflected in the Flotherm thermal model airflow illustration and pictures (see Figure 7-38 and Figure 7-39). The Intel Boxed Boards in the BTX form factor have implemented a System Monitor thermal sensor. The following thermal sensor or its equivalent can be used for this function:

Part Number: C83274-002 BizLink USA Technology, Inc. 44911 Industrial Drive Fremont, CA 94538 USA (510)252-0786 phone (510)252-1178 fax sales@bizlinktech.com	Part Number: 68801-0170 Molex Incorporated 2222 Wellington Ct. Lisle, IL 60532 1-800-78MOLEX phone 1-630-969-1352 fax amerinfo@molex.com
---	--

Figure 7-38. System Airflow Illustration with System Monitor Point Area Identified

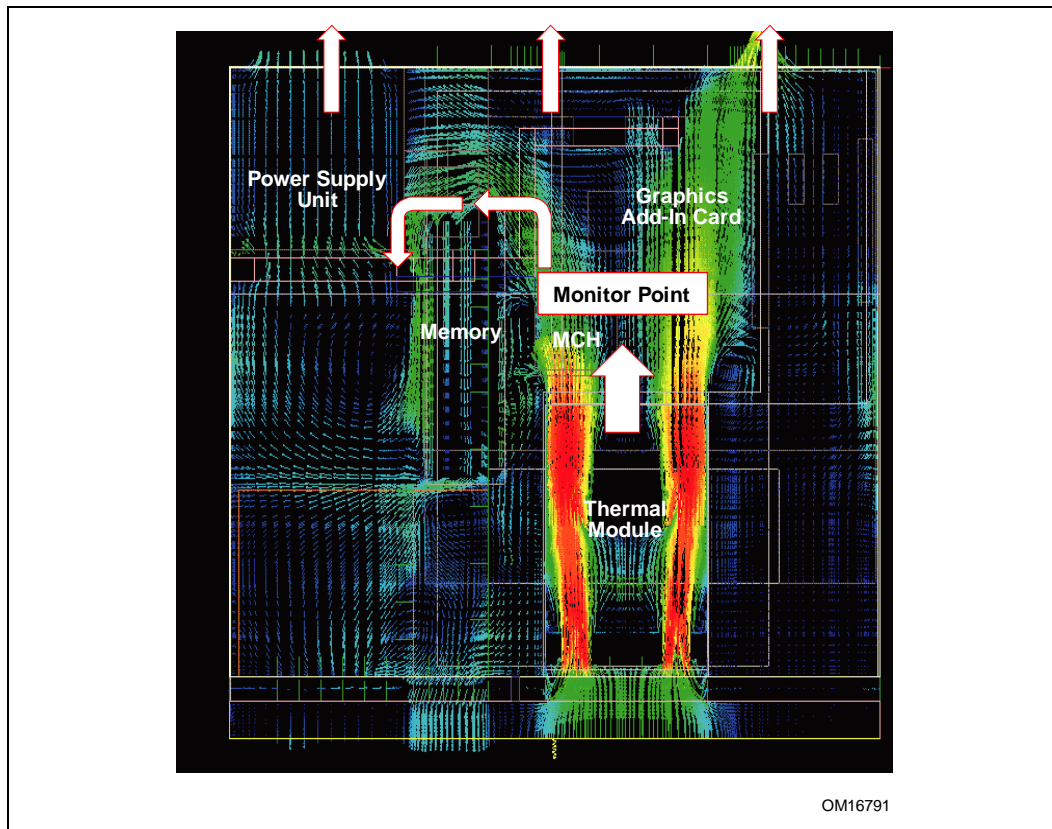
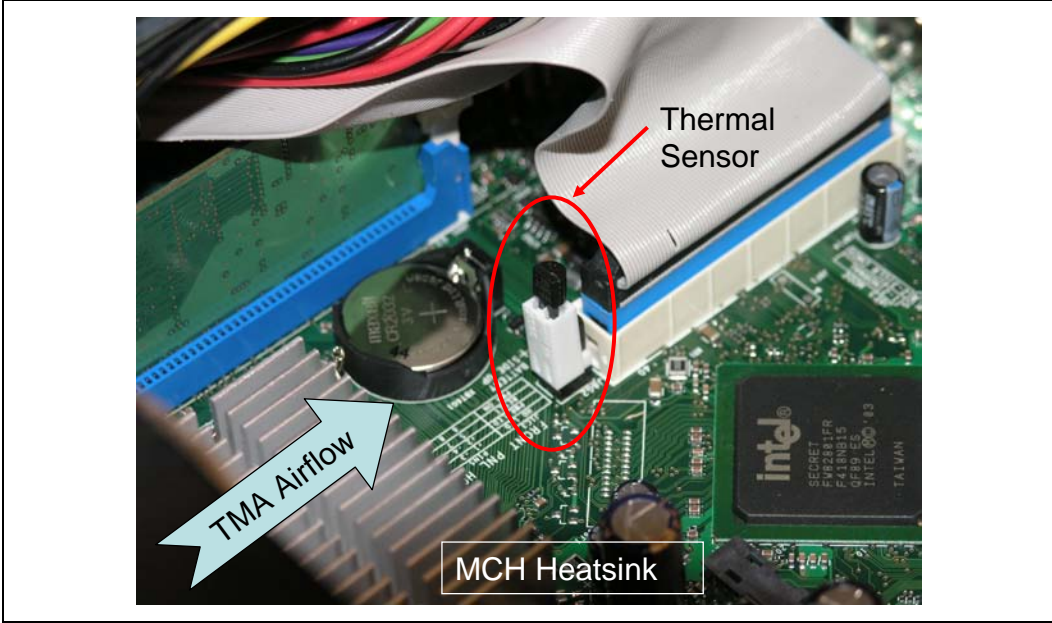




Figure 7-39. Thermal sensor Location Illustration



S





Appendix F Fan Performance for Reference Design

The fan power requirements for proper operation are listed in Table 7–3.

Table 7–3. Fan Electrical Performance Requirements

Requirement	Value
Maximum Average fan current draw	1.5 A
Fan start-up current draw	2.2 A
Fan start-up current draw maximum duration	1.0 second
Fan header voltage	12 V \pm 5%
Tachometer output	2 pulse per revolution
Tachometer output signal	Open-collector (open-drain)
PWM signal input frequency	21 kHz to 28 kHz
PWM signal pull up in fan	3.3 V (recommended max) 5.25 V (absolute max)
PWM signal current source	I _{max} = 5 mA (short circuit current)
PWM signal maximum voltage for logic low	V _{IL} = 0.8 V
PWM compliant function	RPM must be within spec for specified duty cycle

In addition to comply with overall thermal requirements (Sections 5.1.1 and 6.2), and the general environmental reliability requirements (Sections 5.2 and 6.3) the fan should meet the following performance requirements:

- Mechanical wear out represents the highest risk reliability parameter for fans. The capability of the functional mechanical elements (ball bearing, shaft, and tower assembly) must be demonstrated to a minimum useful lifetime of 57,000 hours.
- In addition to passing the environmental reliability tests described in Sections 5.2 and 6.3, the fan must demonstrate adequate performance after 7,500 on/off cycles with each cycle specified as 3 minutes on, 2 minutes off, at a temperature of 70 °C.

See the *Fan Specification for 4-wire PWM Controlled Fans* for additional details on the fan specification.





Appendix G Mechanical Drawings

The following table lists the mechanical drawings included in this appendix. These drawings refer to the reference thermal mechanical enabling components for the processor.

Note: Intel reserves the right to make changes and modifications to the design as necessary.

Drawing Description	Page Number
ATX/μATX Motherboard Keep-out Footprint Definition and Height Restrictions for Enabling Components - Sheet 1	110
ATX/μATX Motherboard Keep-out Footprint Definition and Height Restrictions for Enabling Components - Sheet 2	111
ATX/μATX Motherboard Keep-out Footprint Definition and Height Restrictions for Enabling Components - Sheet 3	112
. BTX Thermal Module Keep Out Volumetric – Sheet 1	113
BTX Thermal Module Keep Out Volumetric – Sheet 2	114
. BTX Thermal Module Keep Out Volumetric – Sheet 3	115
BTX Thermal Module Keep Out Volumetric – Sheet 4	116
BTX Thermal Module Keep Out Volumetric – Sheet 5	117
ATX Reference Clip – Sheet 1	118
ATX Reference Clip - Sheet 2	119
Reference Fastener - Sheet 1	120
Reference Fastener - Sheet 2	121
Reference Fastener - Sheet 3	122
Reference Fastener - Sheet 4	123
Intel® E18764-001 Reference Solution Assembly	124



Figure 7-40. ATX/ μ ATX Motherboard Keep-out Footprint Definition and Height Restrictions for Enabling Components - Sheet 1

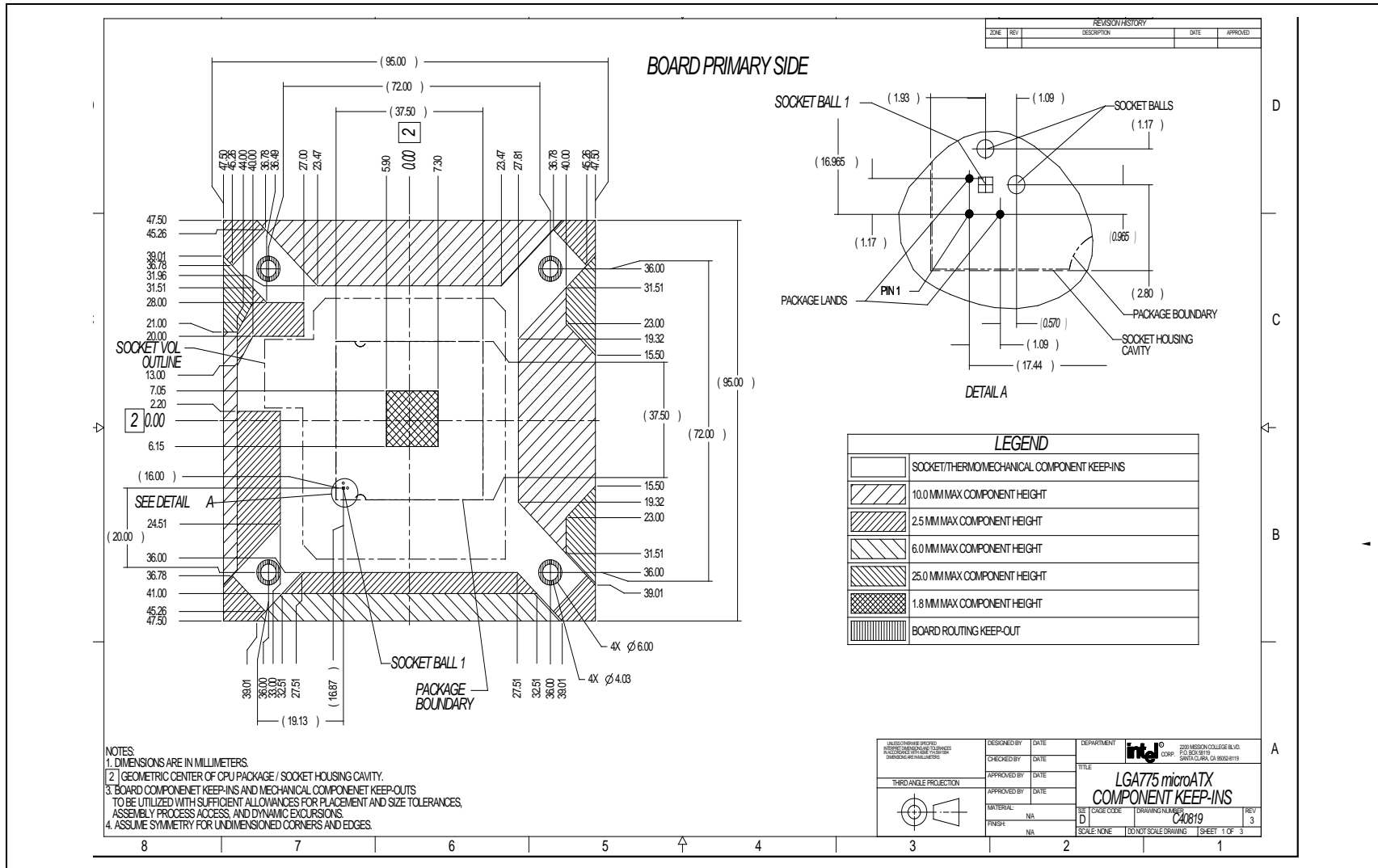




Figure 7-41. ATX/ μ ATX Motherboard Keep-out Footprint Definition and Height Restrictions for Enabling Components - Sheet 2

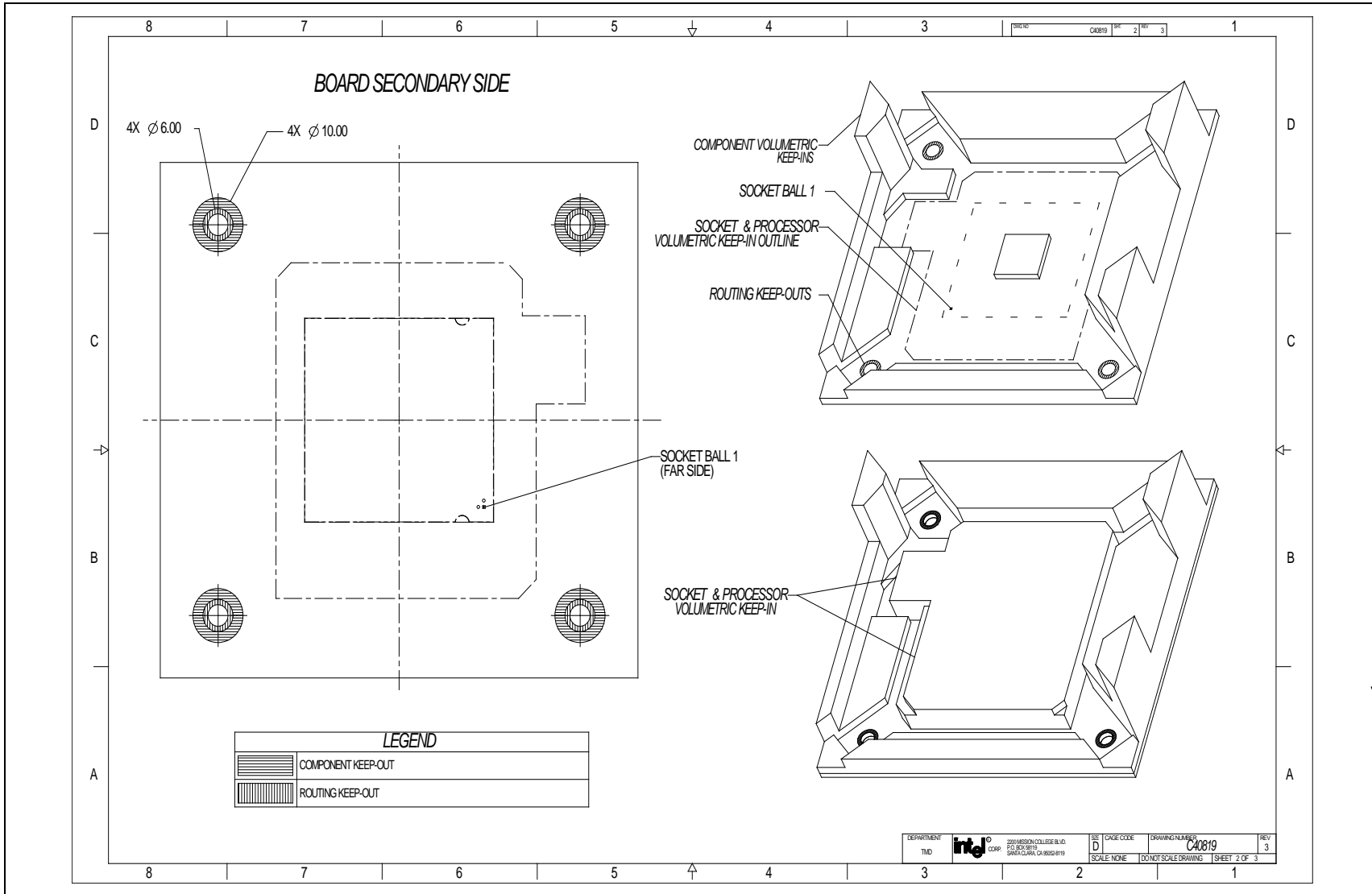




Figure 7-42. ATX/ μ ATX Motherboard Keep-out Footprint Definition and Height Restrictions for Enabling Components - Sheet 3

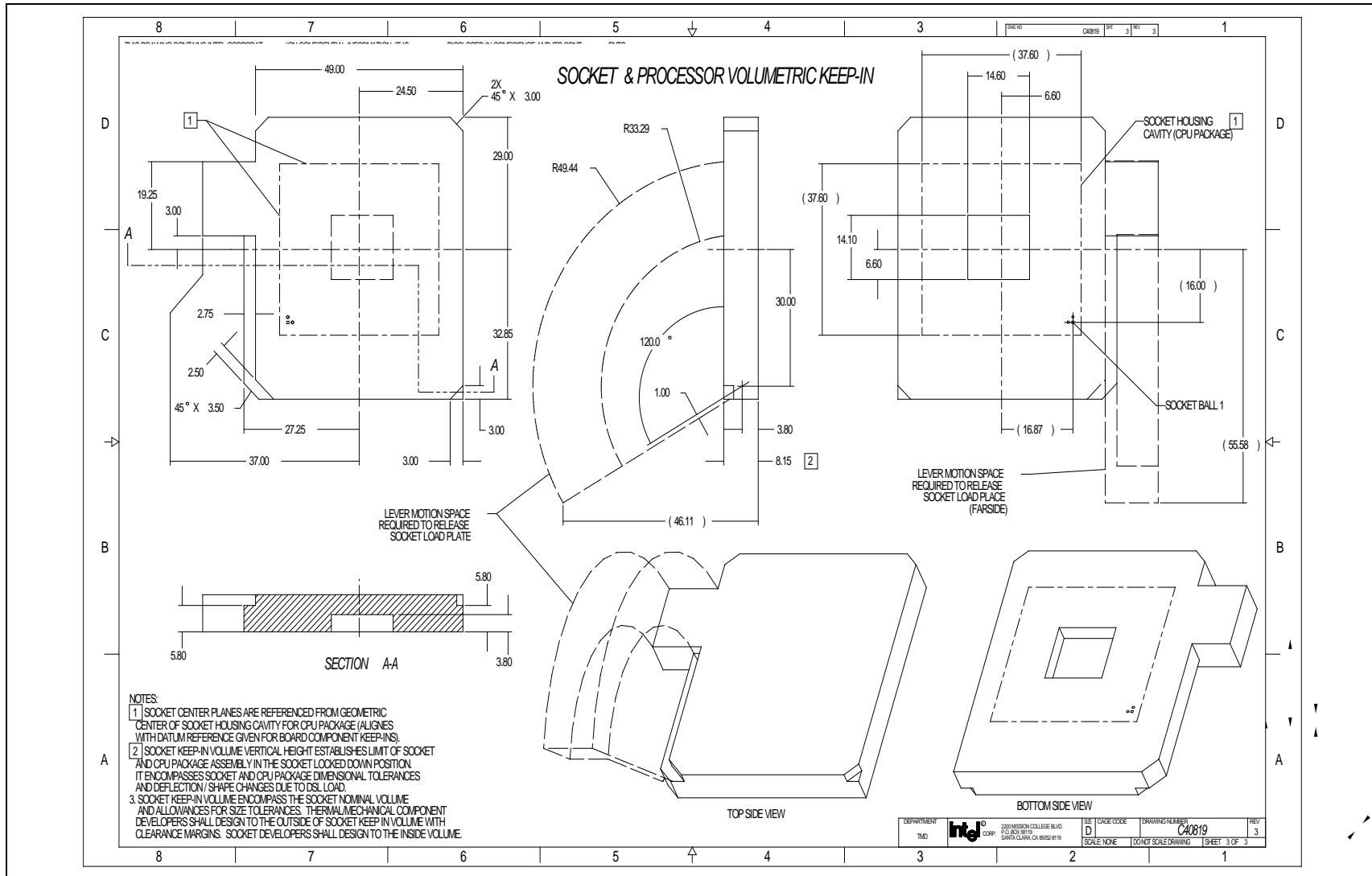




Figure 7-43. BTX Thermal Module Keep Out Volumetric – Sheet 1

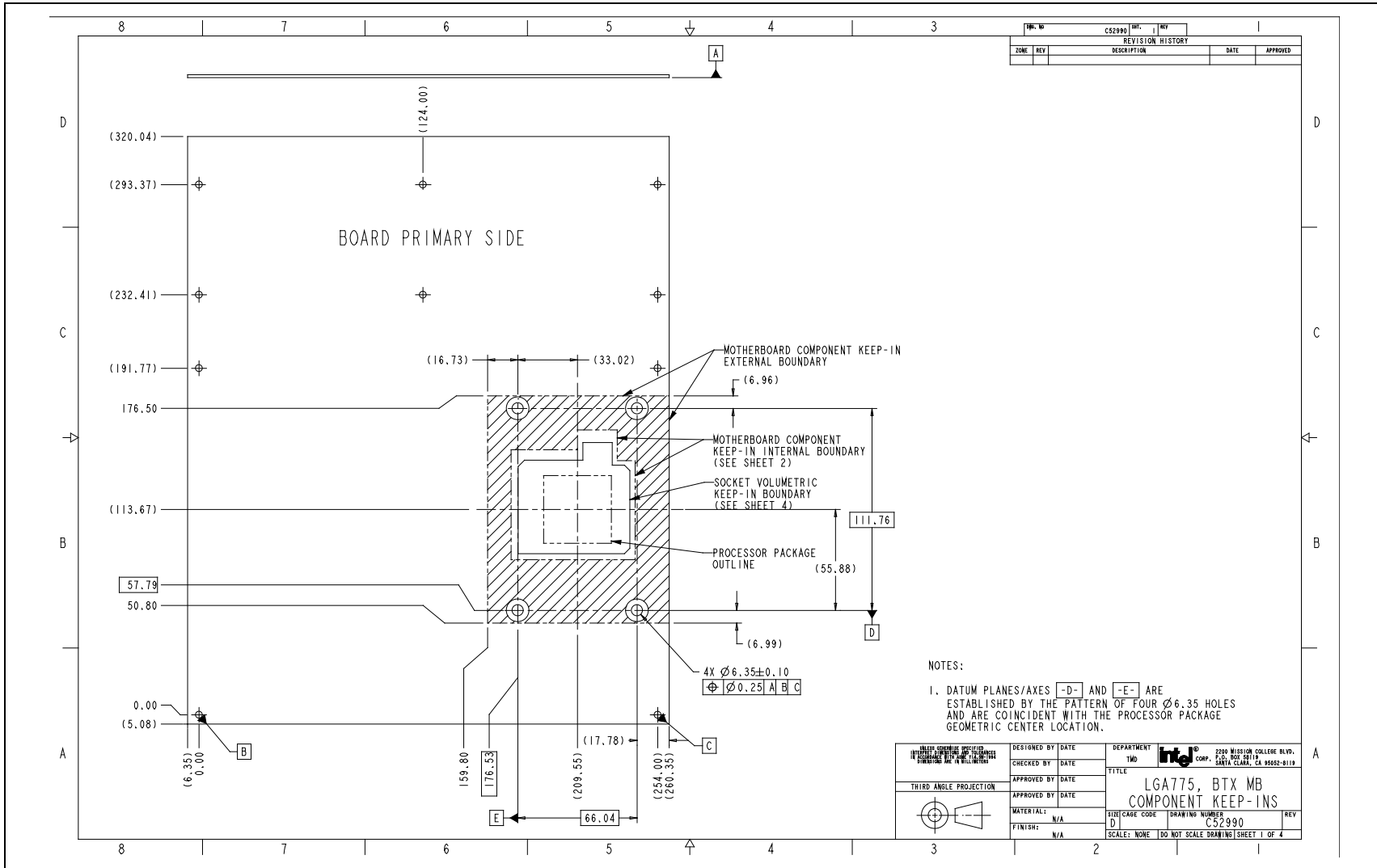




Figure 7-44. BTX Thermal Module Keep Out Volumetric – Sheet 2

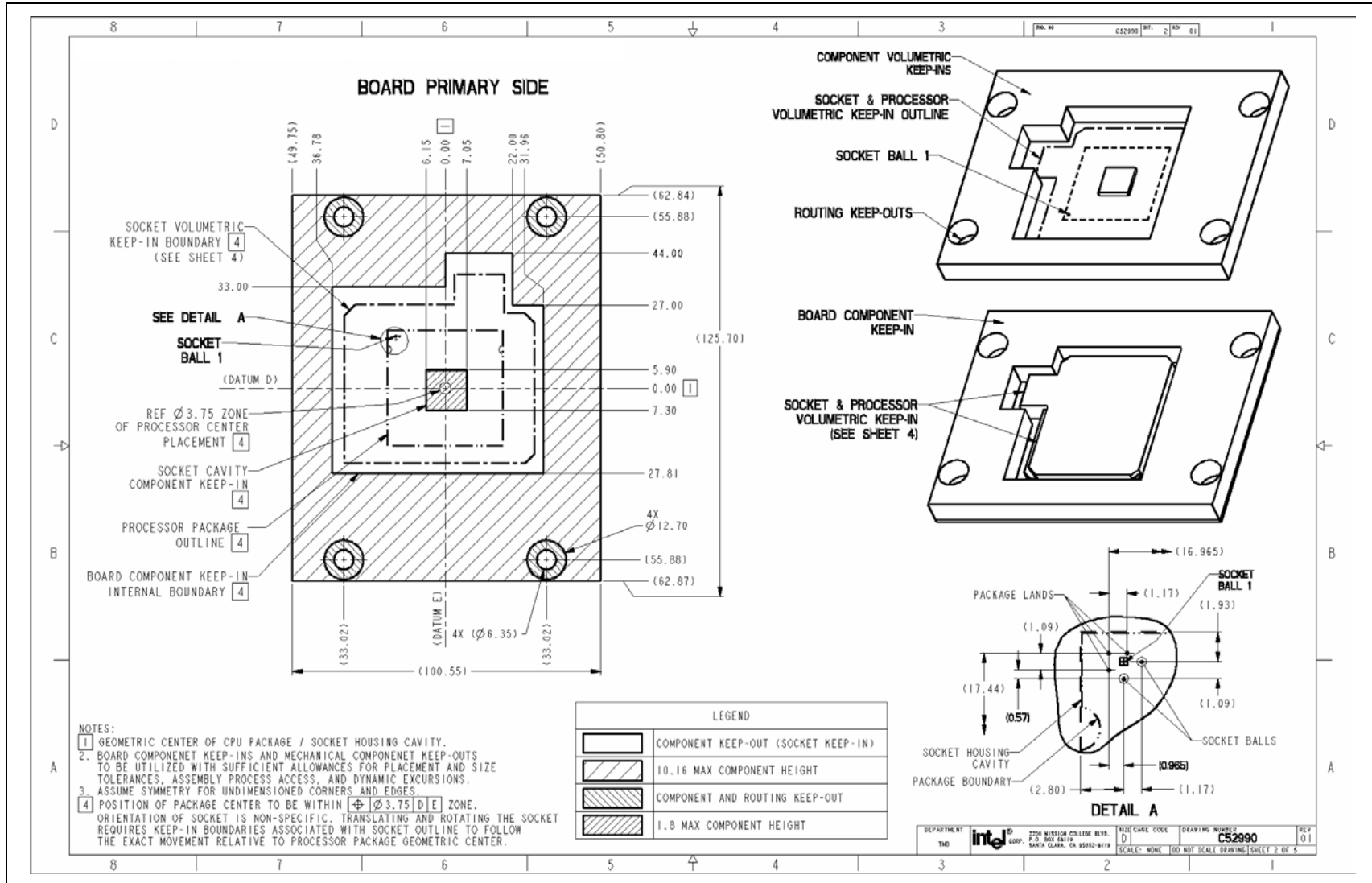


Figure 7-45. BTX Thermal Module Keep Out Volumetric – Sheet 3

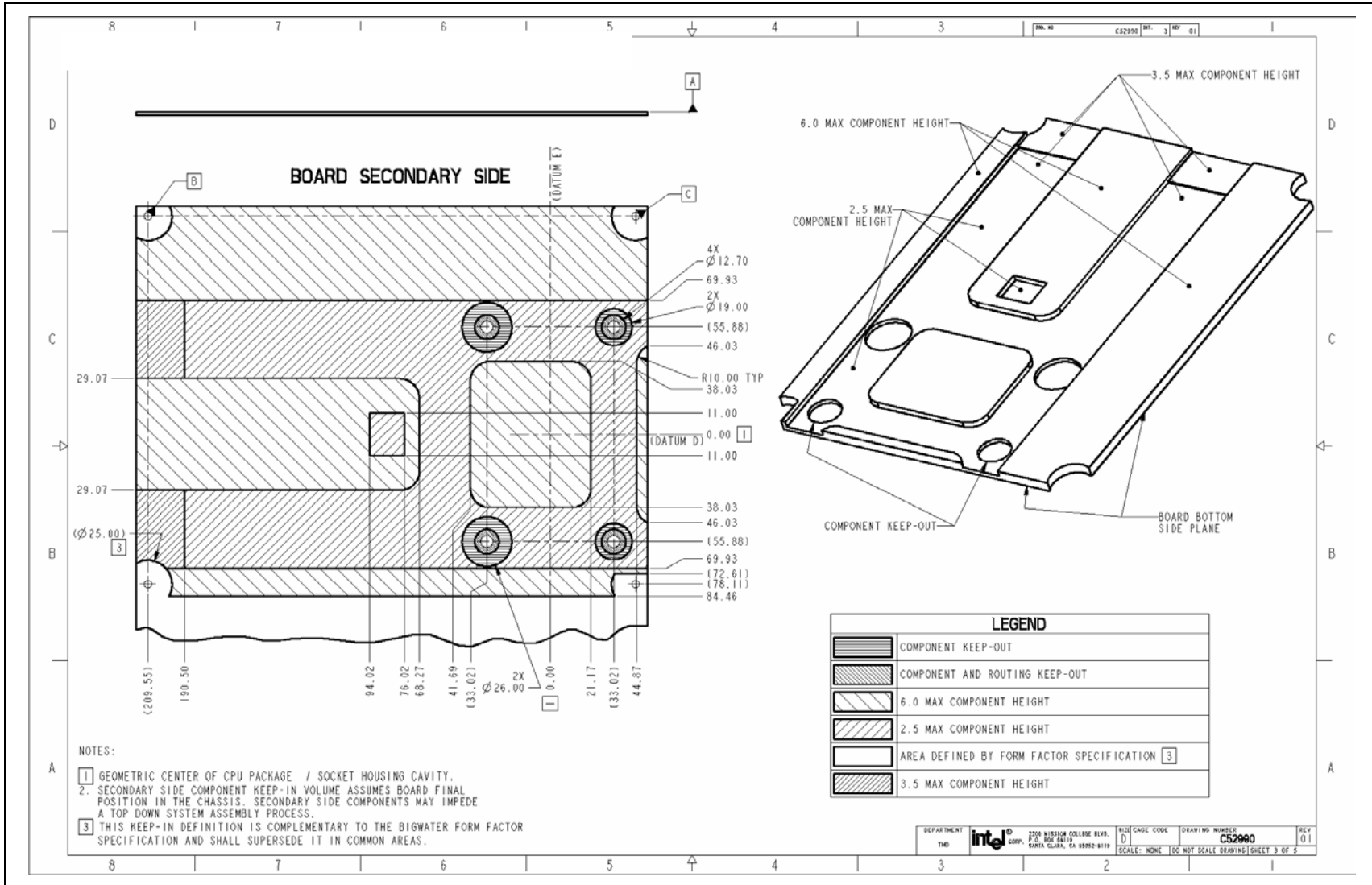




Figure 7-46. BTX Thermal Module Keep Out Volumetric – Sheet 4

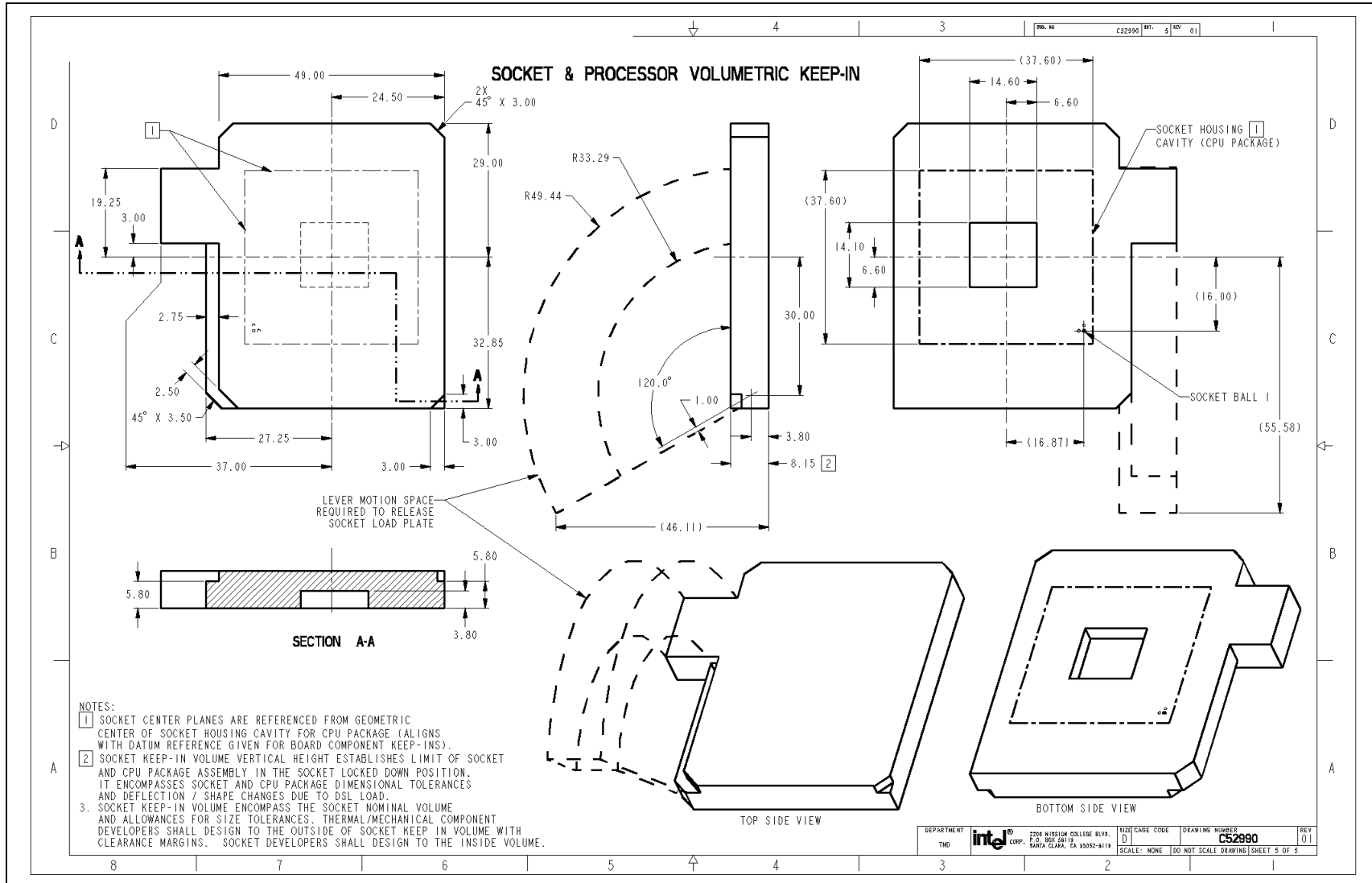


Figure 7-47. BTX Thermal Module Keep Out Volumetric – Sheet 5

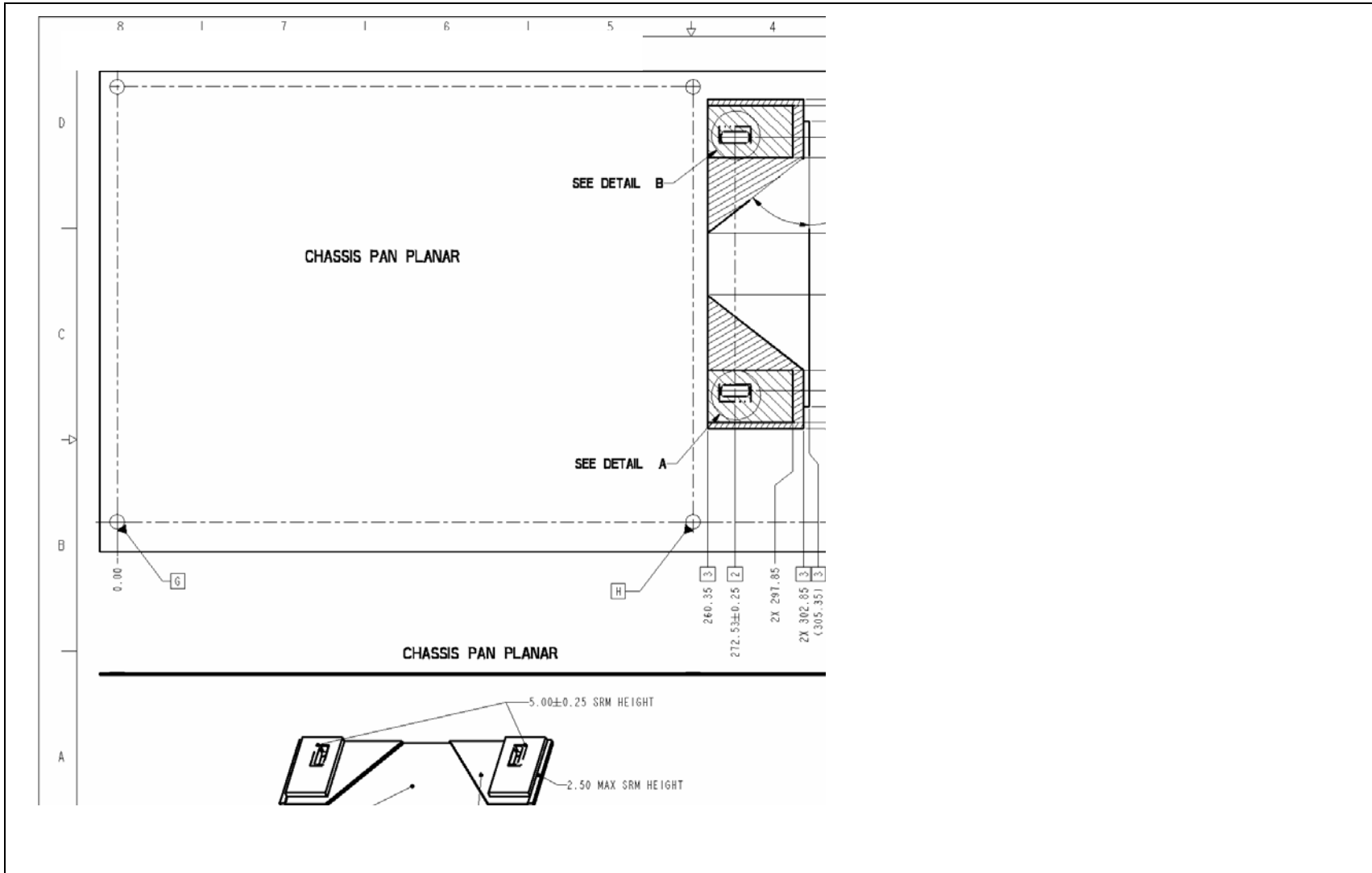




Figure 7-48. ATX Reference Clip – Sheet 1

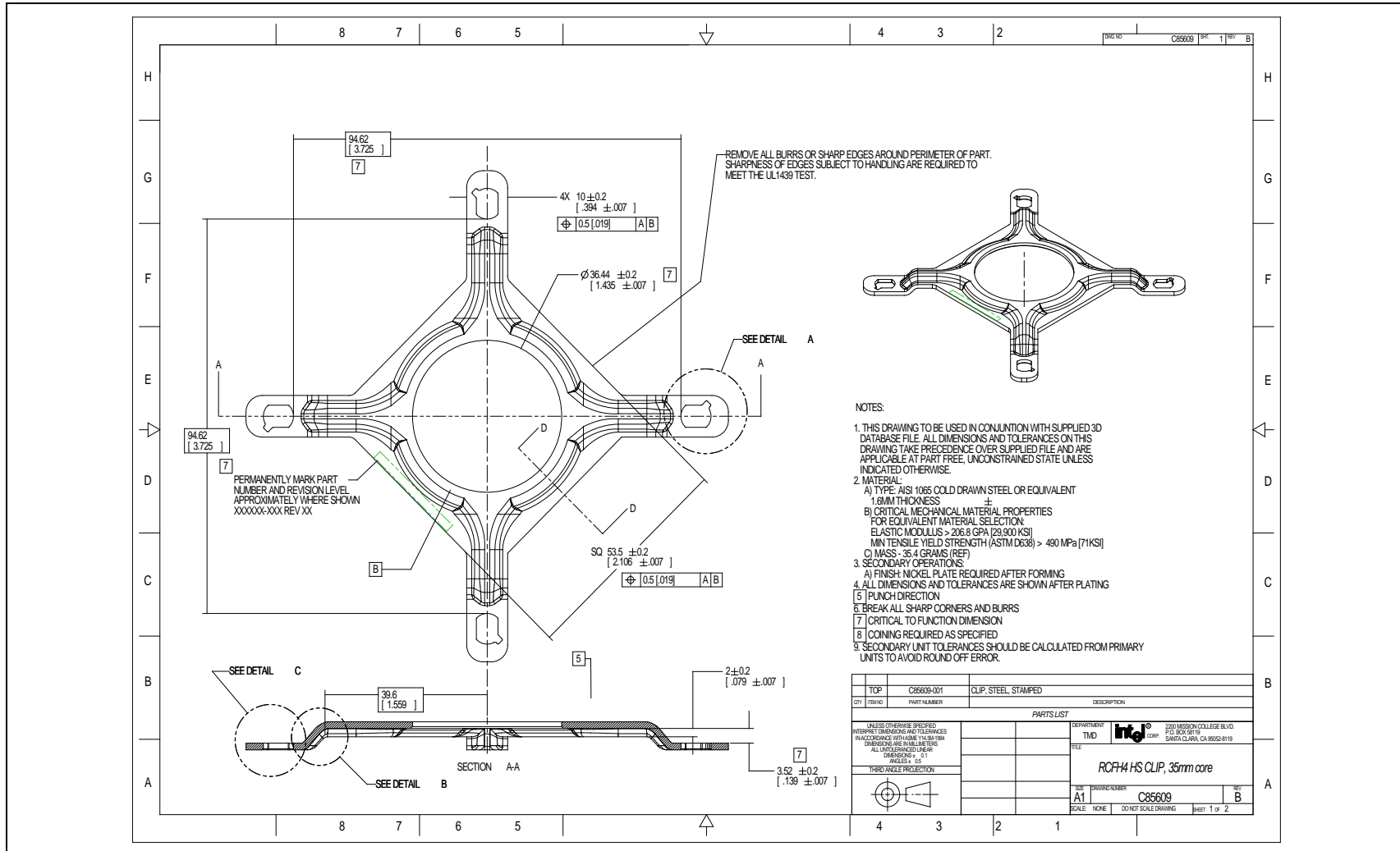




Figure 7-49. ATX Reference Clip - Sheet 2

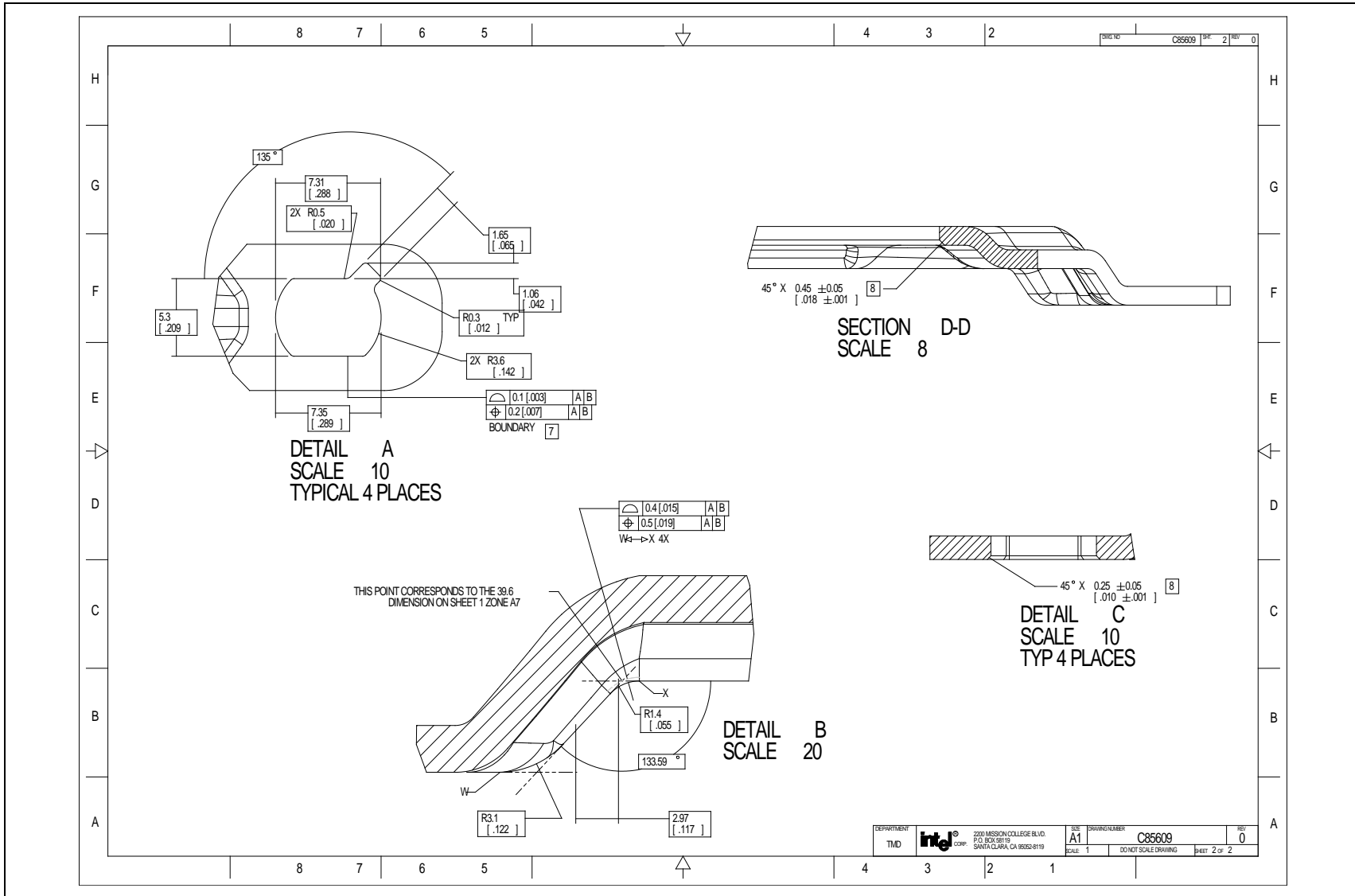


Figure 7-51. Reference Fastener - Sheet 2

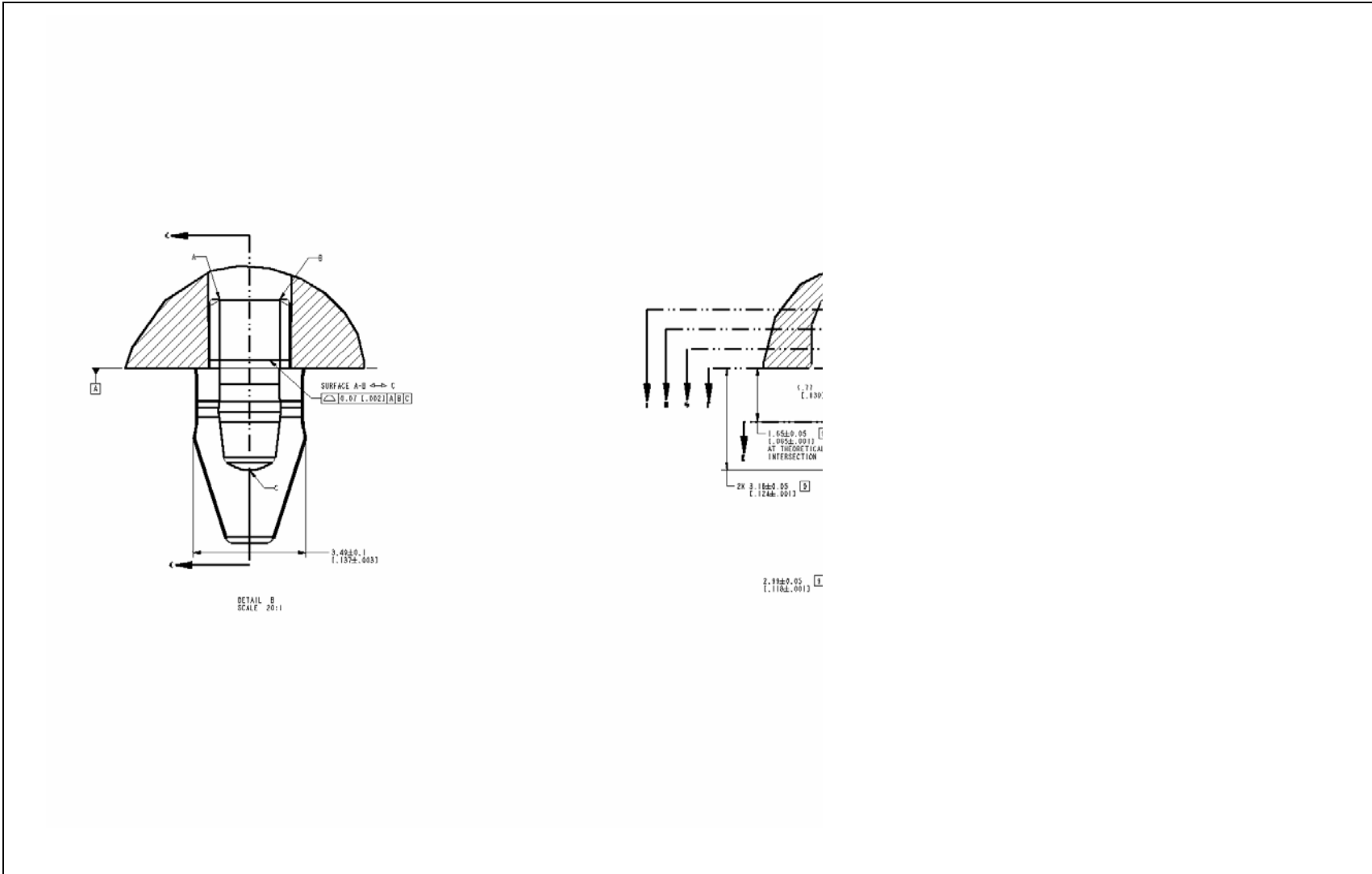


Figure 7-52. Reference Fastener - Sheet 3

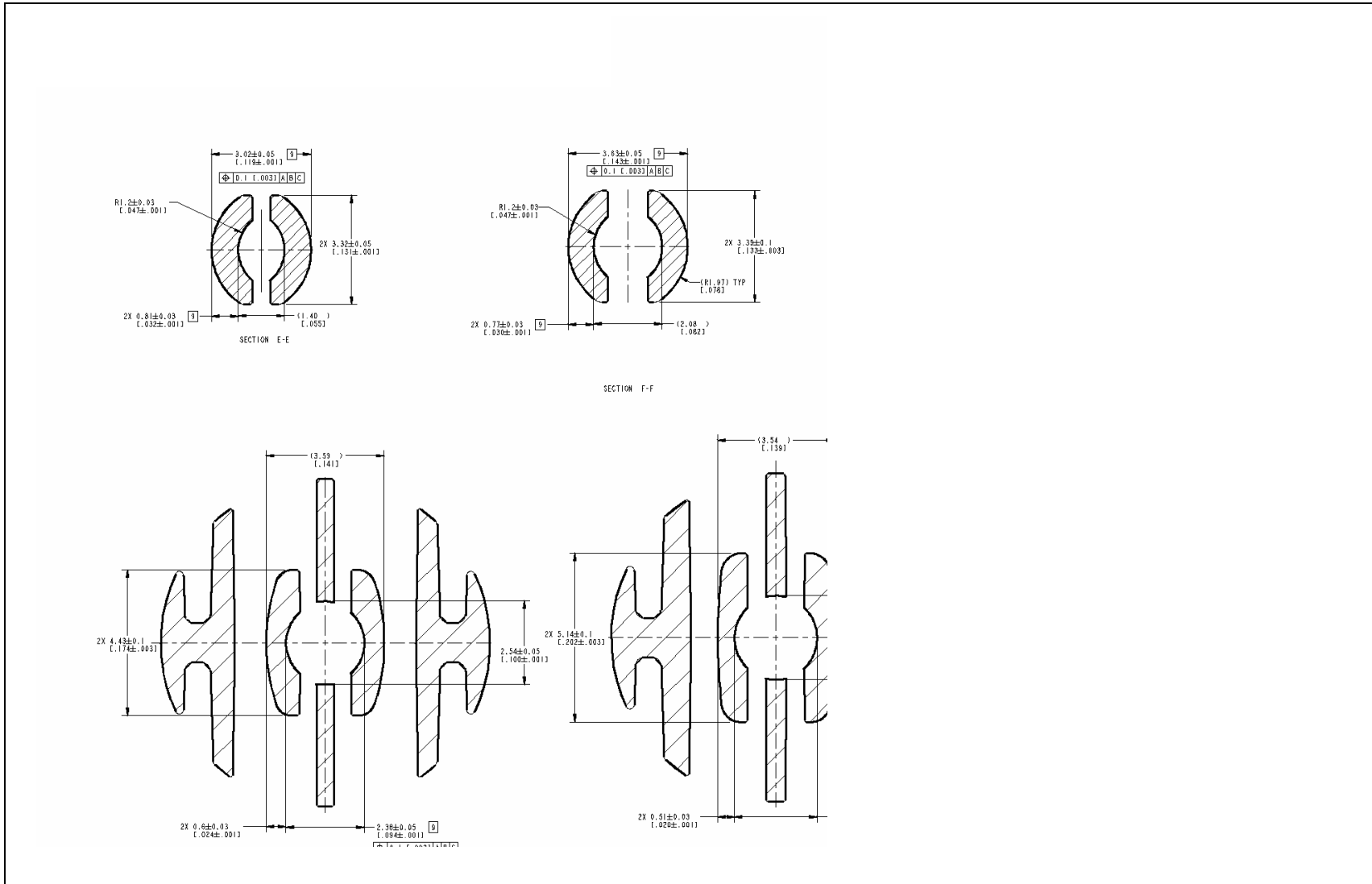


Figure 7-53. Reference Fastener - Sheet 4

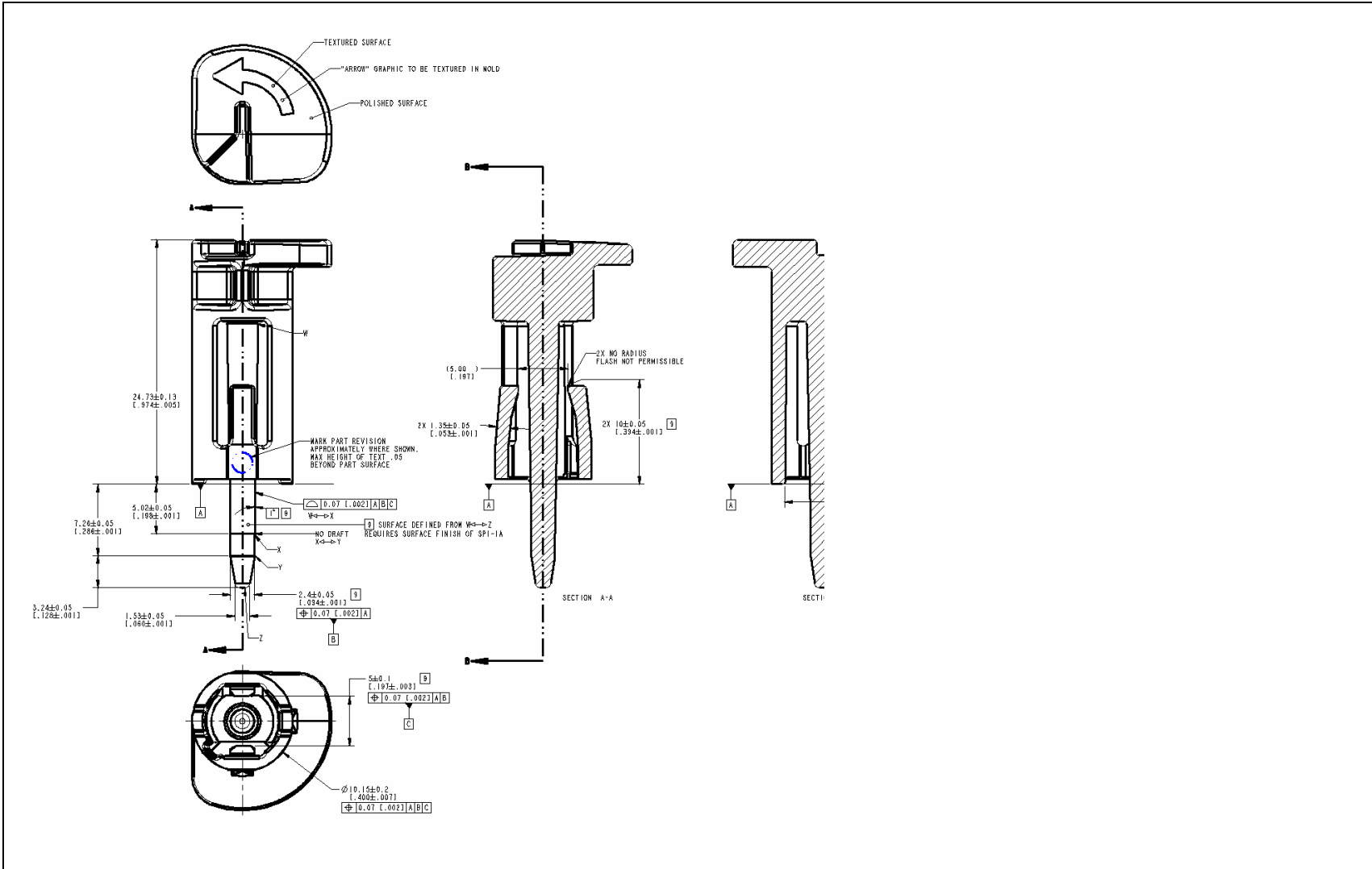
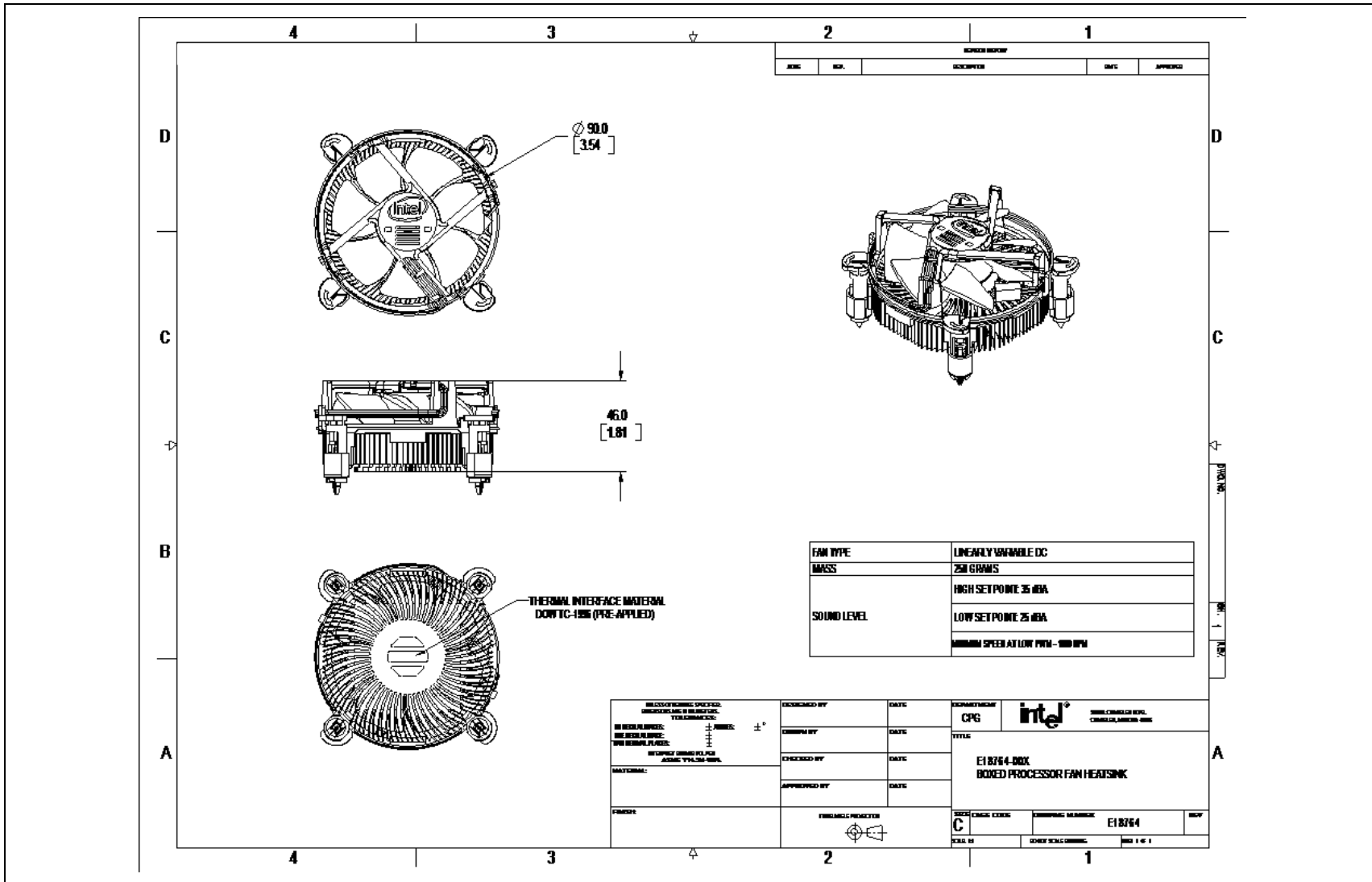




Figure 7-54. Intel® E18764-001 Reference Solution Assembly





Appendix H Intel® Enabled Reference Solution Information

This appendix includes supplier information for Intel enabled vendors for E18764-001 reference design and BTX reference design. The reference component designs are available for adoption by suppliers and heatsink integrators pending completion of appropriate licensing contracts. For more information on licensing, contact the Intel representative mentioned in Table 7–4.

Table 7–4. Intel® Representative Contact for Licensing Information of BTX Reference Design

Company	Contact	Phone	Email
Intel Corporation	Tony De Leon	(253) 371-9339	Tony.deleon@intel.com

The following tables list suppliers that produce Intel enabled reference components. The part numbers listed below identifies these reference components. End-users are responsible for the verification of the Intel enabled component offerings with the supplier. OEMs and System Integrators are responsible for thermal, mechanical, and environmental validation of these solutions.

Table 7–5. E18764-001 Reference Thermal Solution Providers

Supplier	Part Description	Supplier P/N	Contact	Phone	Email
Foxconn*	Intel E18764-001 Reference Solution	1A0127K00-T	Jack Chen Wanchi Chen	408-919-1121 408-919-6135	Jack.Chen@Foxconn.com Wanchi.Chen@Foxconn.com
Fujikura*	Intel E18764-001 Reference Solution	RPG-7029	Yuji Yasuda	408-988-7478	yuji@fujikura.com
Nidec*	Intel E18764-001 Reference Solution	F09A-12BS201AC2H3(CX)	Motokazu Nishimura Karl Mattson	+81-75-935-6480 360-666-2445	MOTOKAZU_NISHIMURA@notes.nidec.co.jp Karl.Mattson@Nidec.com
Foxconn*	Fastener	Base: C33389 Cap: C33390	Wanchi Chen	408-919-6135	Wanchi.Chen@Foxconn.com
ITW Fastex*	Fastener	Base: C33389 Cap: C33390	Roger Knell	773- 307-9035	rknell@itwfastex.com



Note: These vendors and devices are listed by Intel as a convenience to Intel's general customer base, but Intel does not make any representations or warranties whatsoever regarding quality, reliability, functionality, or compatibility of these devices. This list and/or these devices may be subject to change without notice.

Table 7–6. BTX Reference Thermal Solution Providers

Supplier	Part Description	Part Number	Contact	Phone	Notes
Mitac International Corp	Support and Retention Module	–	Michael Tsai	886-3-328-9000 Ext.6545	1
AVC* (ASIA Vital Components Co., Ltd)	Type I Thermal Module Fan Assembly 2004	DB09238B 120084	David Chao	+886-2-22996930 Extension: 619	2
AVC* (ASIA Vital Components Co., Ltd)	Type II Thermal Module Fan Assembly 2004	DB07038B 12UP001	David Chao	+886-2-22996930 Extension: 619	3
TBD	Type II Thermal Module Fan Assembly 65W 2006	TBD	TBD	TBD	4
CCI (Chau-Choung Technology Corp.)	Extrusion	TBD	Harry Lin Monica Chih	714-739-5797 +886-2-29952666 Extension 131	
AVC (ASIA Vital Components Co., Ltd)	Fan and Duct	TBD	David Chao	+886-2-22996930 Extension: 619	

NOTES:

1. Part numbers were not available at the time of release of this document. Contact the company for part number identification prior to the next revision of this document.
2. The user should note that for the 2004 Type I Intel reference Thermal Module Assembly: also meets 2005 Performance (130W) and Mainstream (84W) as well as the 2004 Performance (115W).
3. The user should note that for the 2004 Type II Intel reference Thermal Module Assembly: meets the requirements for 115W 2004 Performance 775_VR_CONFIG_04 and 95W 2005 Mainstream 775_VR_CONFIG_05.
4. The Type II TMA designed for 65W 2006 FMB has been optimized for acoustics and cost. It is not interchangeable with the 95W Type II reference design.

Note: These vendors/devices are listed by Intel as a convenience to Intel's general customer base, but Intel does not make any representations or warranties whatsoever regarding quality, reliability, functionality, or compatibility of these devices. This list and/or these devices may be subject to change without notice.