

CM1418

Praetorian™ L-C EMI Filter with ESD Protection for Headset Speakers

Product Description

The CM1418 is an L-C EMI filter array with ESD protection that integrates two Pi-filters (C-L-C) for a headset speaker. The CM1418 has component values of 117 pF/3.0 nH/117 pF. The parts include ESD protection diodes on all input/output pins, and provide a very high level of protection for sensitive electronic components against possible electrostatic discharge (ESD). The ESD diodes connected to the filter ports safely dissipate ESD strikes of ± 30 kV, which is beyond the maximum requirement of the IEC61000-4-2 international standard. In accordance with MIL-STD-883 (Method 3015) specification for Human Body Model (HBM) ESD, the pins are protected for contact discharges at greater than ± 30 kV.

This device is particularly well suited for portable electronics (e.g. mobile handsets, PDAs, notebook computers) because of its small package format and easy-to-use pin assignments. In particular, the CM1418 is ideal for EMI filtering and protecting speaker output lines of the headset speaker from ESD in mobile handsets. Most speakers have an impedance of 8Ω . However, to maximize the power output, the resistance of an EMI filter needs to be as low as possible. The CM1418 addresses this by using a C-L-C based EMI filter with an inductor having less than 0.35Ω of resistance.

The CM1418 comes with *OptiGuard*™ coating resulting in improved reliability at assembly. The CM1418 is housed in a space saving, low profile Chip Scale Package with RoHS-compliant, lead-free finishing.

Features

- Two Channels of EMI Filtering
- ± 30 kV ESD Protection (IEC 61000-4-2, Contact Discharge)
- ± 30 kV ESD Protection (HBM)
- *OptiGuard*™ Coating for Improved Reliability at Assembly
- Greater than 35 dB of Attenuation at 1 GHz
- 6-Bump, 1.720 mm X 1.220 mm Footprint Chip Scale Package (CSP)
- These Devices are Pb-Free and are RoHS Compliant

Applications

- Headset Speaker Port in Mobile Handsets
- I/O Port Protection for Mobile Handsets, Notebook Computers, PDAs etc.
- EMI Filtering for Data Ports in Cell Phones, PDAs or Notebook Computers



ON Semiconductor®

<http://onsemi.com>



WLCSP6
CP SUFFIX
CASE 567BC

BLOCK DIAGRAM

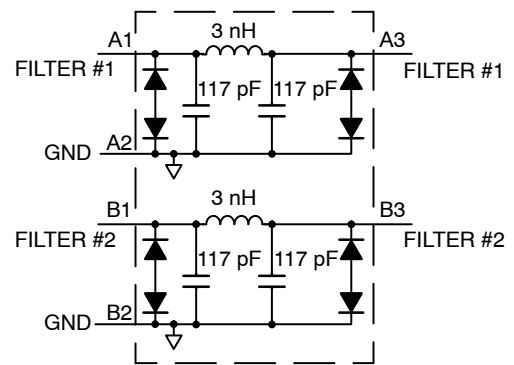

MARKING DIAGRAM

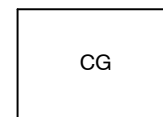

CG = CM1418-02CP

ORDERING INFORMATION

Device	Package	Shipping†
CM1418-02CP	WLCSP6 (Pb-Free)	3500/Tape & Reel

†For information on tape and reel specifications, including part orientation and tape sizes, please refer to our Tape and Reel Packaging Specification Brochure, BRD8011/D.

CM1418

Table 1. PIN DESCRIPTIONS

Pin	Name	Description
A1	Filter #1	Filter #1 Input
A2	GND	Device Ground
A3	Filter #1	Filter #1 Input
B1	Filter #2	Filter #2 Input
B2	GND	Device Ground
B3	Filter #2	Filter #2 Input

PACKAGE / PINOUT DIAGRAMS

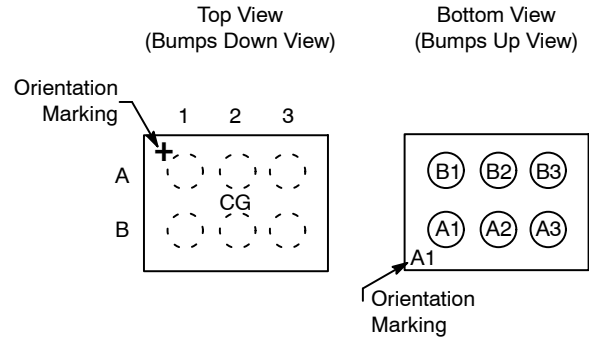

CM1418
WLCSP6 Package

SPECIFICATIONS

Table 2. ABSOLUTE MAXIMUM RATINGS

Parameter	Rating	Units
Storage Temperature Range	-65 to +150	°C
DC Current per Inductor	500	mA
DC Package Power Rating	0.5	W

Stresses exceeding Maximum Ratings may damage the device. Maximum Ratings are stress ratings only. Functional operation above the Recommended Operating Conditions is not implied. Extended exposure to stresses above the Recommended Operating Conditions may affect device reliability.

Table 3. STANDARD OPERATING CONDITIONS

Parameter	Rating	Units
Operating Temperature Range	-40 to +85	°C

Table 4. ELECTRICAL OPERATING CHARACTERISTICS (Note 1)

Symbol	Parameter	Conditions	Min	Typ	Max	Units
L	Inductance			3.0		nH
R	DC Channel Resistance			0.28	0.35	Ω
C _{TOT}	Total Channel Capacitance	2.5 V DC, 1 MHz, 30 mV AC	187	234	281	pF
C ₁	Capacitance C ₁	2.5 V DC, 1 MHz, 30 mV AC	93	117	140	pF
V _{ST}	Stand-off Voltage	I = 10 μA		6.0		V
I _{LEAK}	Diode Leakage Current	V _{IN} = 3.3 V		0.1	1.0	μA
V _{SIG}	Signal Clamp Voltage Positive Clamp Negative Clamp	I _{LOAD} = 10 mA I _{LOAD} = -10 mA	5.6 -9.0	6.8 -6.8	9.0 -5.6	V
V _{ESD}	In-system ESD Withstand Voltage a) Human Body Model, MIL-STD-883, Method 3015 b) Contact Discharge per IEC 61000-4-2 Level 4	(Note 2)	±30 ±30			kV
R _{DYN}	Dynamic Resistance Positive Negative			0.95 0.90		Ω
f _C	Cut-off Frequency, Z _{SOURCE} = 50 Ω, Z _{LOAD} = 50 Ω	L = 3 nH, C = 117 pF		22		MHz

1. T_A = 25°C unless otherwise specified.
2. ESD applied to input and output pins with respect to GND, one at a time.

CM1418

PERFORMANCE INFORMATION

Typical Filter Performance (nominal conditions unless specified otherwise, 50 Ω Environment)

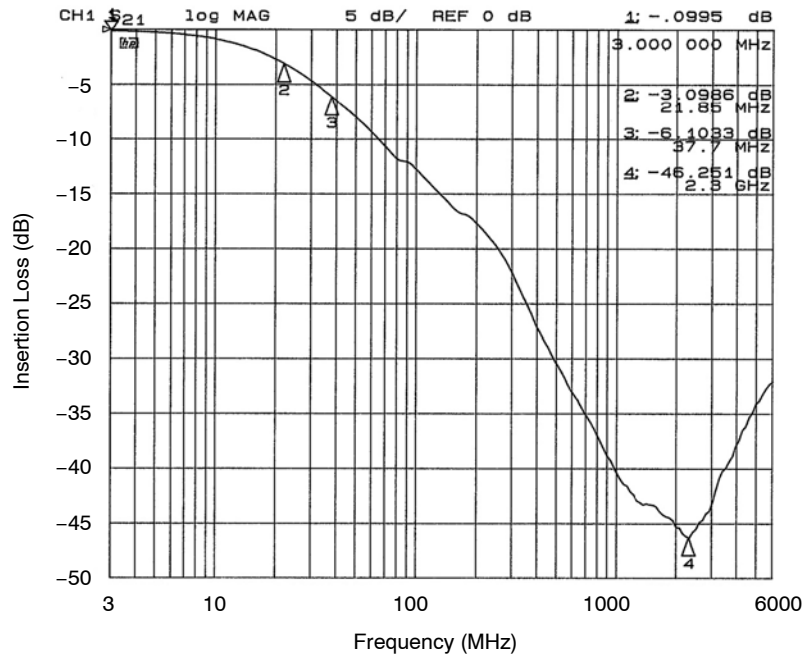

Figure 1. Insertion Loss vs. Frequency (Filter #1 to GND B2)

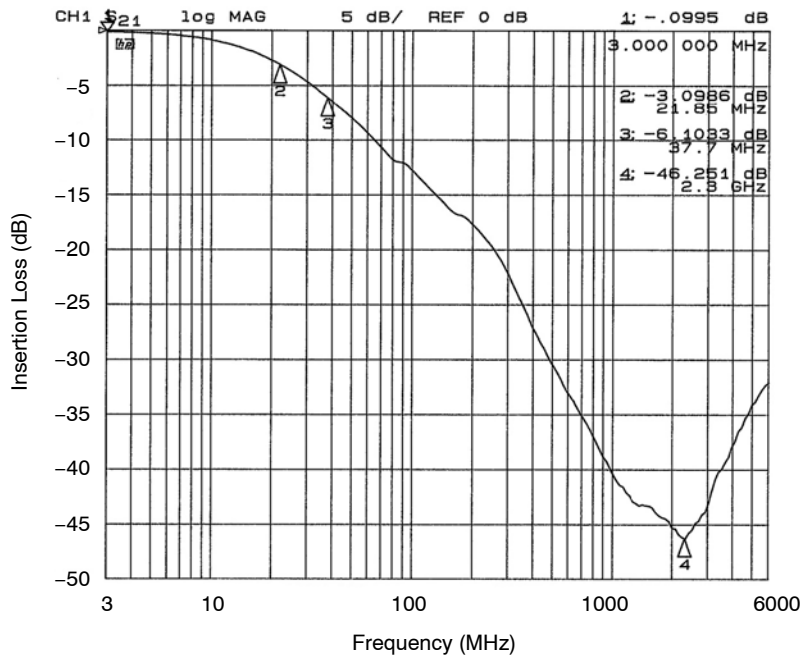

Figure 2. Insertion Loss vs. Frequency (Filter #2 to GND B2)

PERFORMANCE INFORMATION (Cont'd)

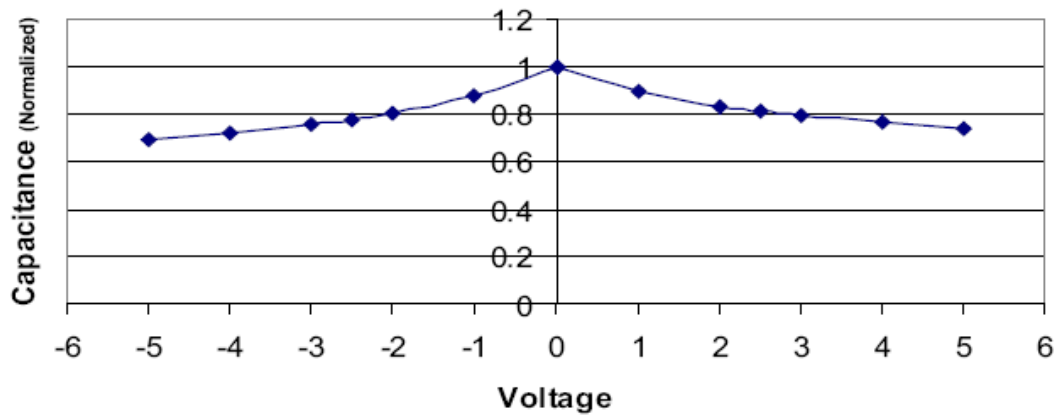

Figure 3. Typical Diode Capacitance vs. Input Voltage (normalized to 2.5 V DC)

CM1418

APPLICATION INFORMATION

Parameter	Value
Pad Size on PCB	0.240 mm
Pad Shape	Round
Pad Definition	Non-Solder Mask defined pads
Solder Mask Opening	0.290 mm Round
Solder Stencil Thickness	0.125 mm – 0.150 mm
Solder Stencil Aperture Opening (laser cut, 5% tapered walls)	0.300 mm Round
Solder Flux Ratio	50/50 by volume
Solder Paste Type	No Clean
Pad Protective Finish	OSP (Entek Cu Plus 106A)
Tolerance – Edge To Corner Ball	±50 μm
Solder Ball Side Coplanarity	±20 μm
Maximum Dwell Time Above Liquidous	60 seconds
Maximum Soldering Temperature for Lead-free Devices using a Lead-free Solder Paste	260°C

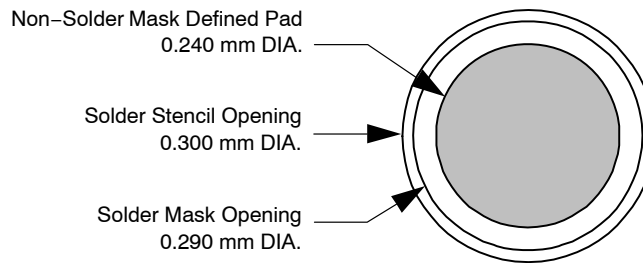

Figure 4. Recommended Non-Solder Mask Defined Pad Illustration

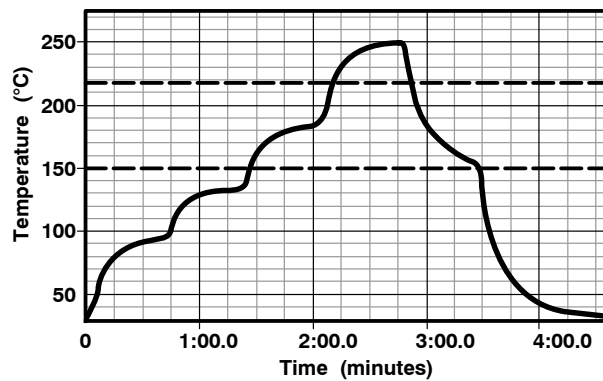

Figure 5. Lead-free (SnAgCu) Solder Ball Reflow Profile

MECHANICAL CASE OUTLINE

PACKAGE DIMENSIONS

ON Semiconductor®



SCALE 4:1

WLCSP6, 1.72x1.22
CASE 567BC-01
ISSUE O

DATE 26 JUL 2010

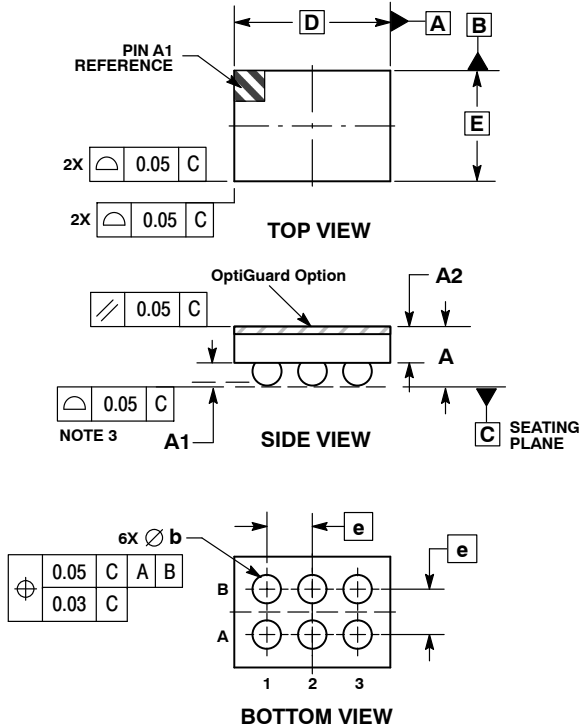

NOTES:

1. DIMENSIONING AND TOLERANCING PER ASME Y14.5M, 1994.
2. CONTROLLING DIMENSION: MILLIMETERS.
3. COPLANARITY APPLIES TO SPHERICAL CROWNS OF SOLDER BALLS.

DIM	MILLIMETERS	
	MIN	MAX
A	0.56	0.72
A1	0.21	0.27
A2	0.42 REF	
b	0.29	0.35
D	1.72 BSC	
E	1.22 BSC	
e	0.50 BSC	

RECOMMENDED SOLDERING FOOTPRINT*

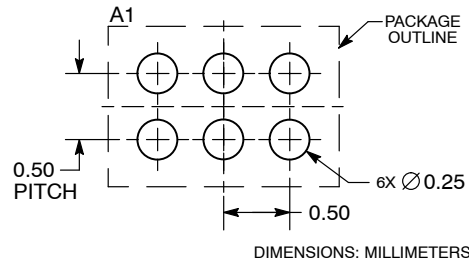

*For additional information on our Pb-Free strategy and soldering details, please download the ON Semiconductor Soldering and Mounting Techniques Reference Manual, SOLDERRM/D.

DOCUMENT NUMBER:	98AON49812E	Electronic versions are uncontrolled except when accessed directly from the Document Repository. Printed versions are uncontrolled except when stamped "CONTROLLED COPY" in red.
DESCRIPTION:	WLCSP6, 1.72X1.22	PAGE 1 OF 1

ON Semiconductor and are trademarks of Semiconductor Components Industries, LLC dba ON Semiconductor or its subsidiaries in the United States and/or other countries. ON Semiconductor reserves the right to make changes without further notice to any products herein. ON Semiconductor makes no warranty, representation or guarantee regarding the suitability of its products for any particular purpose, nor does ON Semiconductor assume any liability arising out of the application or use of any product or circuit, and specifically disclaims any and all liability, including without limitation special, consequential or incidental damages. ON Semiconductor does not convey any license under its patent rights nor the rights of others.

onsemi, **Onsemi**, and other names, marks, and brands are registered and/or common law trademarks of Semiconductor Components Industries, LLC dba "**onsemi**" or its affiliates and/or subsidiaries in the United States and/or other countries. **onsemi** owns the rights to a number of patents, trademarks, copyrights, trade secrets, and other intellectual property. A listing of **onsemi**'s product/patent coverage may be accessed at www.onsemi.com/site/pdf/Patent-Marking.pdf. **onsemi** reserves the right to make changes at any time to any products or information herein, without notice. The information herein is provided "as-is" and **onsemi** makes no warranty, representation or guarantee regarding the accuracy of the information, product features, availability, functionality, or suitability of its products for any particular purpose, nor does **onsemi** assume any liability arising out of the application or use of any product or circuit, and specifically disclaims any and all liability, including without limitation special, consequential or incidental damages. Buyer is responsible for its products and applications using **onsemi** products, including compliance with all laws, regulations and safety requirements or standards, regardless of any support or applications information provided by **onsemi**. "Typical" parameters which may be provided in **onsemi** data sheets and/or specifications can and do vary in different applications and actual performance may vary over time. All operating parameters, including "Typicals" must be validated for each customer application by customer's technical experts. **onsemi** does not convey any license under any of its intellectual property rights nor the rights of others. **onsemi** products are not designed, intended, or authorized for use as a critical component in life support systems or any FDA Class 3 medical devices or medical devices with a same or similar classification in a foreign jurisdiction or any devices intended for implantation in the human body. Should Buyer purchase or use **onsemi** products for any such unintended or unauthorized application, Buyer shall indemnify and hold **onsemi** and its officers, employees, subsidiaries, affiliates, and distributors harmless against all claims, costs, damages, and expenses, and reasonable attorney fees arising out of, directly or indirectly, any claim of personal injury or death associated with such unintended or unauthorized use, even if such claim alleges that **onsemi** was negligent regarding the design or manufacture of the part. **onsemi** is an Equal Opportunity/Affirmative Action Employer. This literature is subject to all applicable copyright laws and is not for resale in any manner.

ADDITIONAL INFORMATION

TECHNICAL PUBLICATIONS:

Technical Library: www.onsemi.com/design/resources/technical-documentation
onsemi Website: www.onsemi.com

ONLINE SUPPORT: www.onsemi.com/support

For additional information, please contact your local Sales Representative at www.onsemi.com/support/sales