

CLICKER 2 ^{PIC24}

the possibilities are endless

A compact starter kit with your favorite microcontroller and two mikroBUS™ sockets

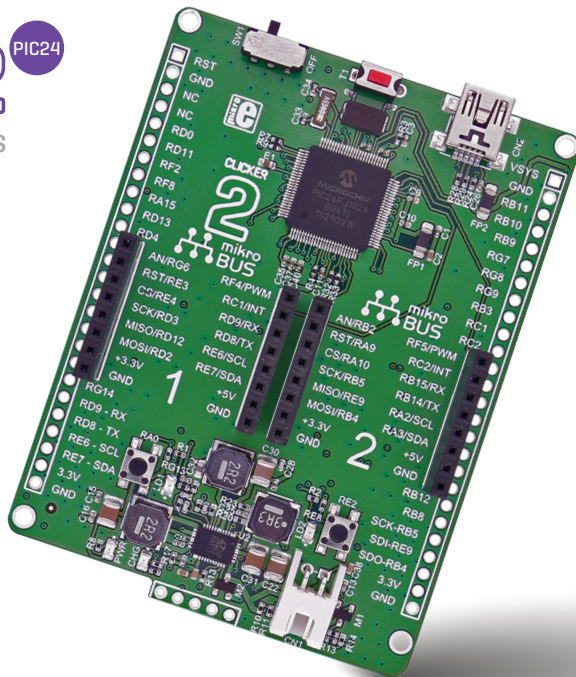

TO OUR VALUED CUSTOMERS

I want to express my thanks to you for being interested in our products and for having confidence in MikroElektronika.

The primary aim of our company is to design and produce high quality electronic products and to constantly improve the performance thereof in order to better suit your needs.

A handwritten signature in white ink, appearing to read 'N. Matic', is positioned on the right side of the page. The signature is fluid and cursive, with a long horizontal stroke extending to the right.

Nebojsa Matic
General Manager

Table of contents

Introduction to clicker 2 for PIC24	4	3.2 Programming with mikroProg programmer	14
Key features	5	mikroProg Suite for PIC® software	15
Schematic	6	4. Buttons and LEDs	16
1. Power supply	7	5. Power management and battery charger	17
2. PIC24FJ1024GB610 microcontroller	8	6. Oscillators	18
3. Programming the microcontroller	9	7. USB connection	19
3.1 Programming with mikroBootloader	10	8. Pinout	20
step 1 – Connecting clicker 2 for PIC24	10	8.1 mikroBUS™ pinout	21
step 2 – Browsing for .HEX file	11	9. click boards™ are plug and play!	22
step 3 – Selecting .HEX file	11	10. Dimensions	23
step 4 – Uploading .HEX file	12		
step 5 – Finish upload	13		

Introduction to clicker 2 for PIC24

clicker 2 for PIC24 is a compact development kit with two mikroBUS™ sockets for click board™ connectivity. You can use it to quickly build your own gadgets with unique functionalities and features. It carries the PIC24FJ1024GB610, a 16-bit microcontroller, two indication LEDs, two general purpose buttons, a reset button, an ON/OFF switch, a li-polymer battery connector, a micro USB connector and two mikroBUS™ sockets. A mikroProg connector and a 2x26 pinout for interfacing with external electronics are also provided. The mikroBUS™ connector consists of two 1x8 female headers with SPI, I2C, UART, RST, PWM, Analog and Interrupt lines as well as 3.3V, 5V and GND power lines. clicker 2 for PIC24 board can be powered over a USB cable.

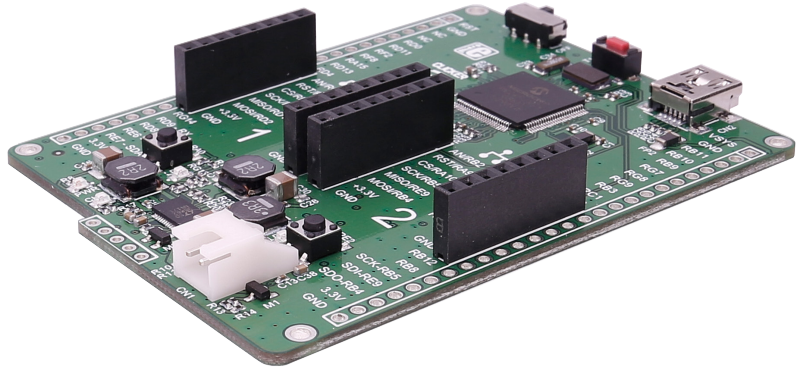

Key features

- 1 ON/OFF switch
- 2 8 MHz crystal oscillator
- 3 two 1x26 connection pads
- 4 mikroBUS™ sockets 1 and 2
- 5 Pushbuttons
- 6 Additional LEDs
- 7 LTC3586 USB power manager IC
- 8 Power and Charge indication LEDs
- 9 RESET button
- 10 Micro USB connector
- 11 PIC24FJ1024GB610 MCU
- 12 Li-Polymer battery connector
- 13 mikroProg programmer connector
- 14 32.768 KHz crystal oscillator

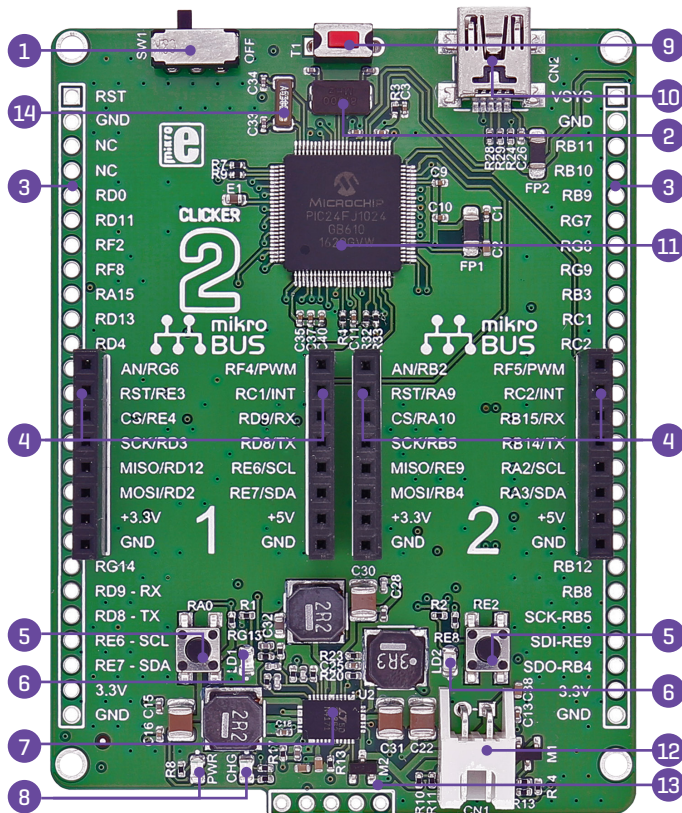

Schematic

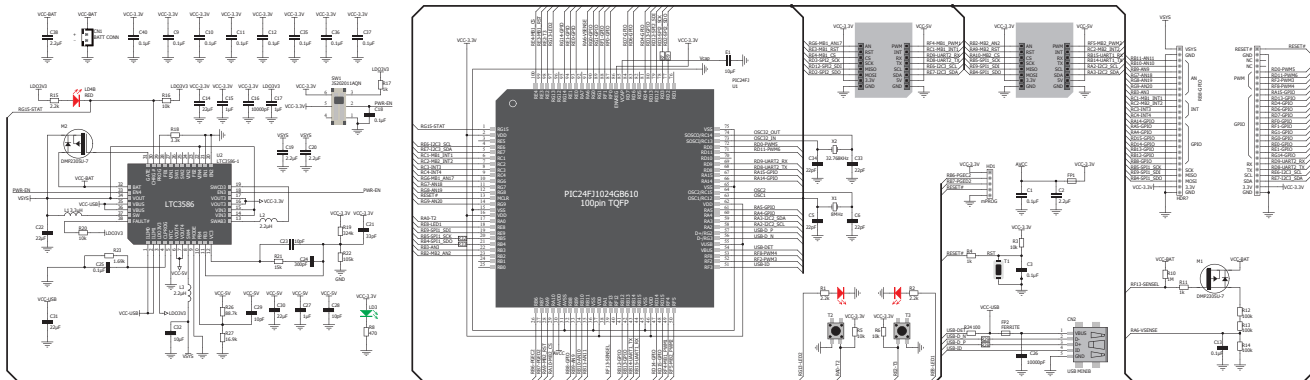

1. Power supply

Figure 1-1: Connecting USB power supply

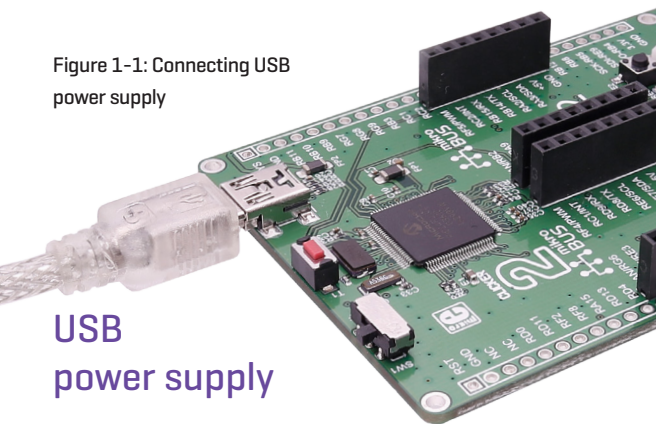

USB power supply

You can supply power to the board with a micro USB cable provided in the package. On-board voltage regulators provide the appropriate voltage levels to each component on the board. Power LED [GREEN] will indicate the presence of power supply.

NOTE | Some click boards need more current than the USB connection can supply. For 3.3V clicks, the upper limit is 750 mA; for 5V clicks, it's 500 mA. In those cases you would need to use the battery as the power supply, or the vsys pin on the side of the board.

Battery power supply

You can also power the board using a Li-Polymer battery, via onboard battery connector. On-board battery charger circuit enables you to charge the battery over USB connection. LED diode [RED] will indicate when battery is charging. Charging current is ~300mA and charging voltage is 4.2V DC.t

Figure 1-2: Connecting Li-Polymer battery



2. PIC24FJ1024GB610 microcontroller

The clicker 2 for PIC24 development tool comes with the PIC24FJ1024GB610 device. This 16-bit microcontroller features large dual partition flash with live update capability. This family includes up to 1024KB Flash, 32KB RAM, USB and advanced peripherals.

Key MCU features

- CPU speed: 16 MIPS
- Architecture: 16-bit
- Program memory: 1024KB
- Pin count: 100
- USB v2.0 On-The-Go (OTG) Compliant



3. Programming the microcontroller

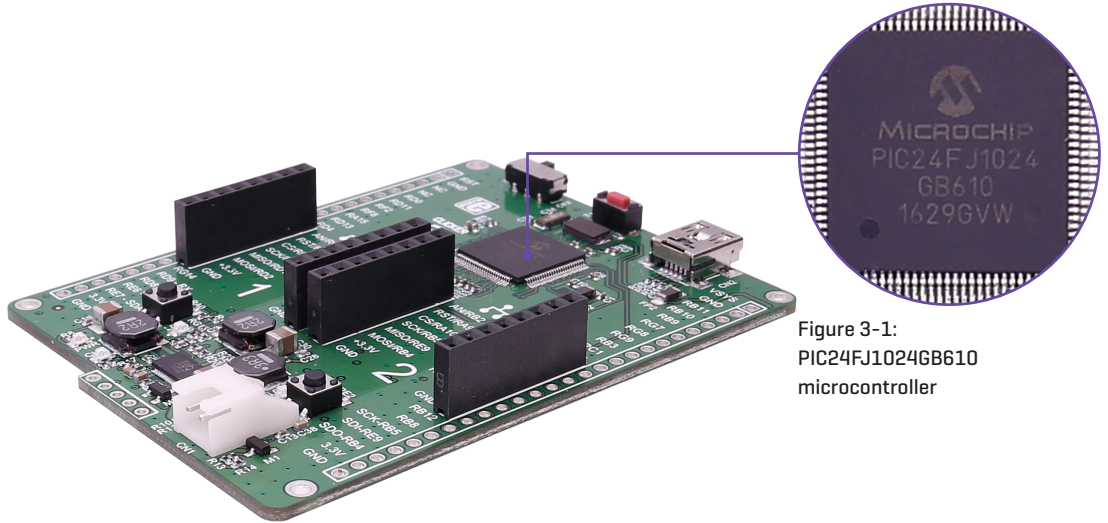

Figure 3-1:
PIC24FJ1024GB610
microcontroller

The microcontroller can be programmed in two ways:

- Using USB HID mikroBootloader,
- Using external mikroProg for PIC24 programmer

3.1 Programming with mikroBootloader

You can program the microcontroller with a bootloader which is preprogrammed by default. To transfer .hex file from a PC to MCU you need bootloader software [mikroBootloader USB HID] which can be downloaded from:

<https://download.mikroe.com/examples/starter-boards/clicker-2/pic24/clicker-2-pic24-bootloader.zip>

After the mikroBootloader software is downloaded, unzip it to desired location and start it.

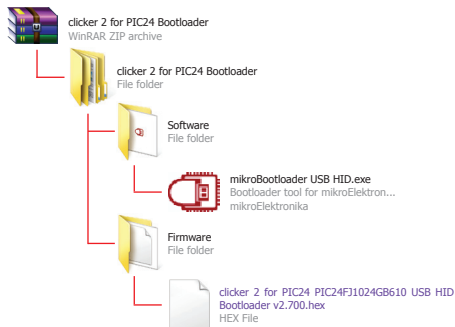

step 1 – Connecting clicker 2 for PIC24



Figure 3-2: USB HID mikroBootloader window

- 01** To start, connect the USB cable, or if already connected press the Reset button on your clicker 2 for PIC24. Click the Connect button within 5s to enter the bootloader mode, otherwise existing microcontroller program will execute.

step 2 – Browsing for .HEX file



Figure 3-3: Browse for HEX

- 01 Click the Browse for HEX button and from a pop-up window [Figure 3.4] choose the .HEX file which will be uploaded to MCU memory.

step 3 – Selecting .HEX file

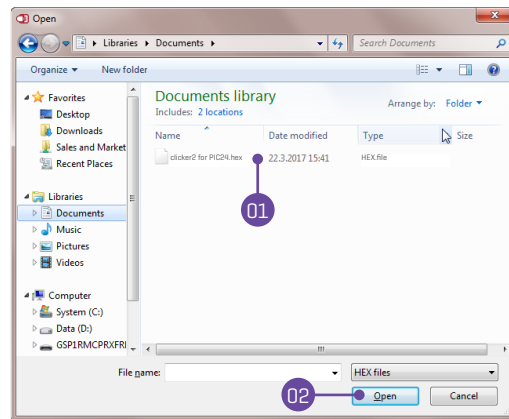

Figure 3-4: Selecting HEX

- 01 Select .HEX file using open dialog window.
- 02 Click the Open button.

step 4 – Uploading .HEX file



Figure 3-5: Begin uploading

- 01 To start .HEX file bootloading click the **Begin uploading** button.



Figure 3-6: Progress bar

- 01 Progress bar enables you to monitor .HEX file uploading.

step 5 – Finish upload

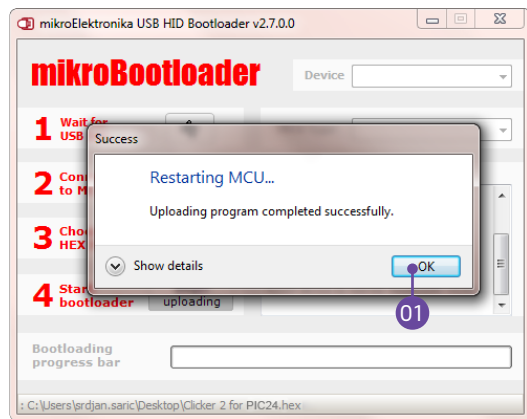

Figure 3-7: Restarting MCU

- 01 Click **OK** button after the uploading process is finished.
- 02 Press **Reset button** on clicker 2 for PIC24 board and wait for 5 seconds. Your program will run automatically.



Figure 3-8: mikroBootloader ready for next job

3.2 Programming with mikroProg programmer

The microcontroller can be programmed with external **mikroProg for PIC programmer** and **mikroProg Suite for PIC software**.

The external programmer is connected to the development system via 1x5 connector **Figure 3-9. mikroProg** is a fast USB 2.0 programmer with hardware debugger support. It supports PIC10®, dsPIC30/33®, PIC24® and PIC32® devices in a single programmer. It supports over 1100 microcontrollers from Microchip®. Outstanding performance, easy operation and elegant design are its key features.

You can also program it with ICD2® or ICD3® if you reroute the wires like shown here.

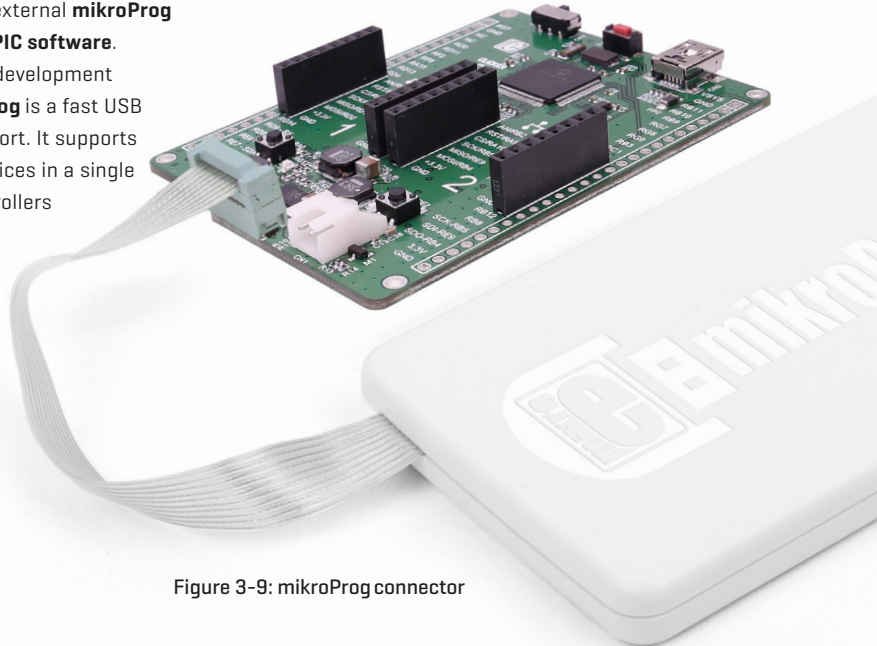
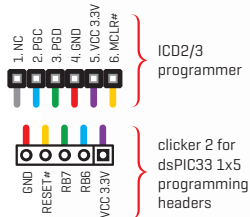

Figure 3-9: mikroProg connector

mikroProg Suite for PIC24[®] software



mikroProg programmer requires special programming software called **mikroProg Suite for dsPIC[®]**. This software is used for programming of ALL Microchip[®] microcontroller families, including PIC10[®], PIC12[®], PIC16[®], PIC18[®], dsPIC30/33[®], PIC24[®] and PIC32[®]. Software has intuitive interface and SingleClick[™] programming technology. Just by downloading the latest version of **mikroProg Suite** your programmer is ready to program new devices. **mikroProg Suite** is updated regularly, at least four times a year, so your programmer will be more and more powerful with each new release.

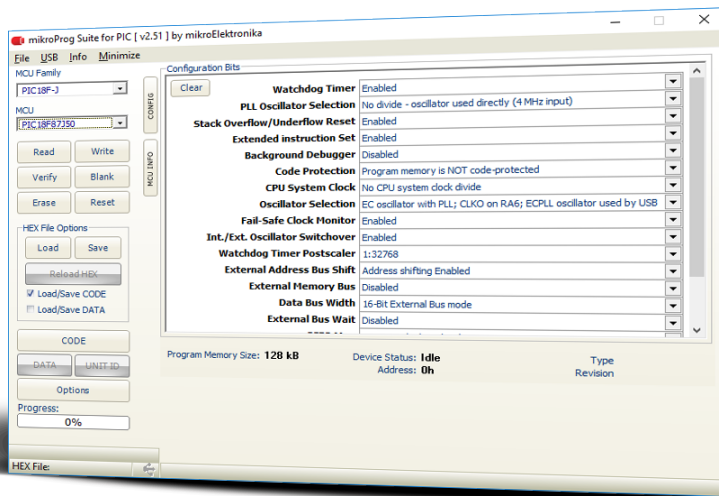

Figure 3-10: Main window of mikroProg Suite for dsPIC[®] programming software

4. Buttons and LEDs

The board also contains a **01 reset button** and a pair of **02 buttons** and **03 LEDs**, as well as an ON/OFF switch. The RESET button is used to manually reset the microcontroller—it generates a low voltage level on the microcontroller’s reset pin. LEDs can be used for visual indication of the logic state on two pins [RG13 and RE8]. An active LED indicates that a logic high [1] is present on the pin. Pressing any of the two buttons can change the logic state of the microcontroller pins [T2 and T3] from logic high [1] to logic low [0].

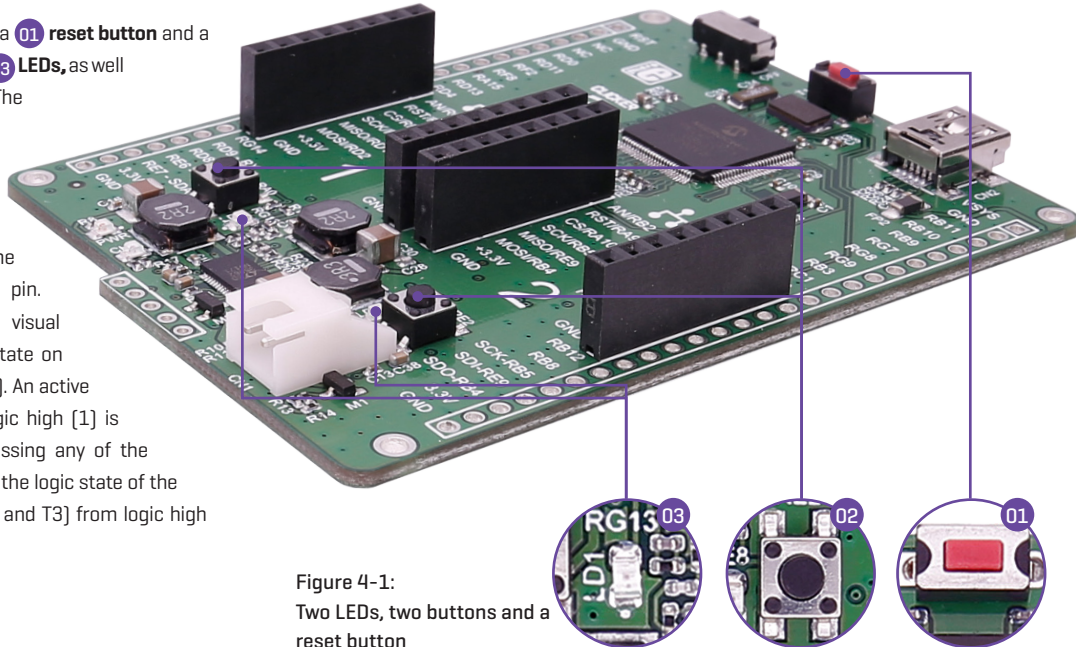

Figure 4-1:
Two LEDs, two buttons and a
reset button

6. Oscillators

Board is equipped with 8MHz crystal oscillator [X1] circuit that provides external clock waveform to the microcontroller CLKO and CLKI pins. This base frequency is suitable for further clock multipliers and ideal for generation of necessary USB clock, which ensures proper operation of bootloader and your custom USB-based applications. There is also 32.768 KHz crystal oscillator for the RTC

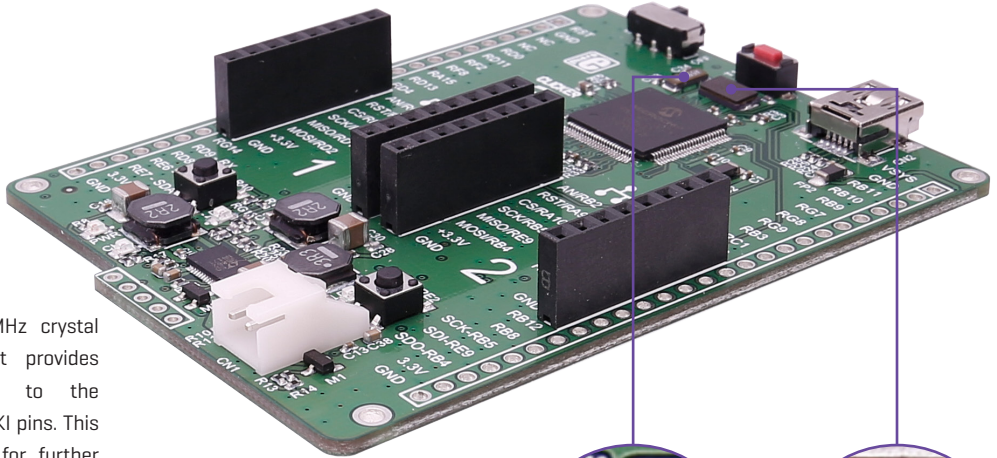
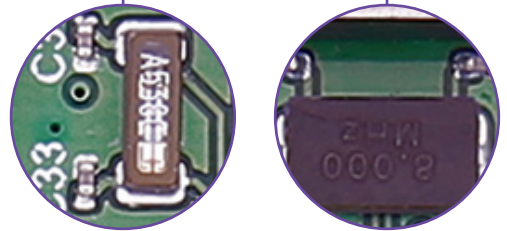

Figure 6-1:
8MHz crystal oscillator module [X1] and 32.768 KHz crystal oscillator



7. USB connection

PIC24 microcontrollers have an integrated USB module, which enables you to implement USB communication functionality to your clicker 2 board. Connection with target USB host is done over a micro USB connector which is positioned next to the battery connector.

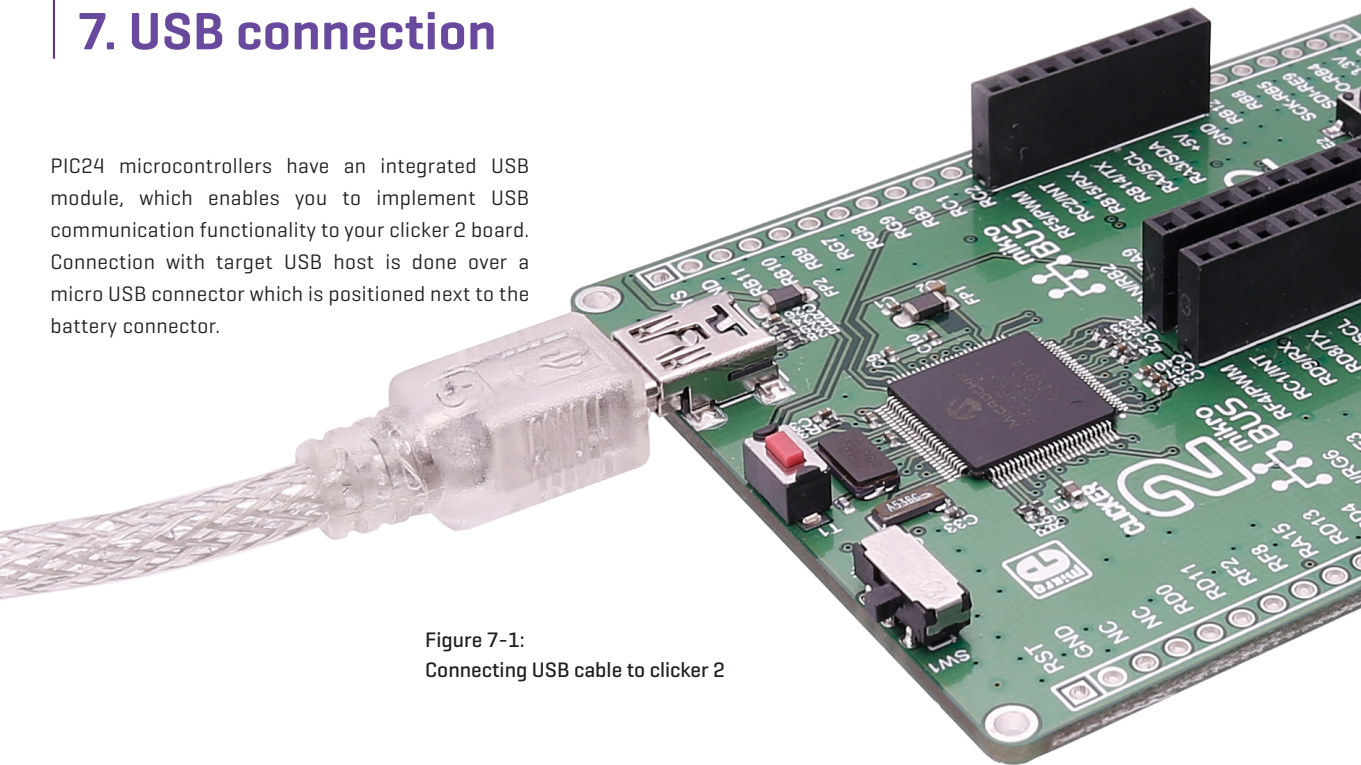
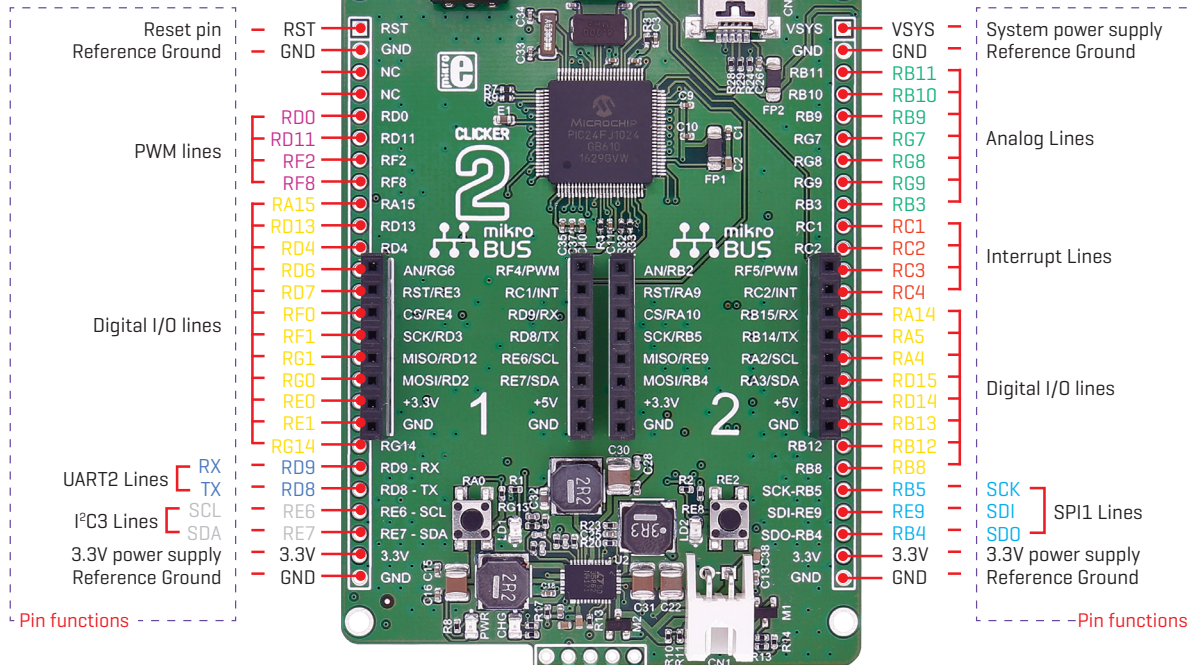

Figure 7-1:
Connecting USB cable to clicker 2

8. Pinout



■ Digital lines
 ■ Analog Lines
 ■ Interrupt Lines
 ■ SPI Lines
 ■ I2C Lines
 ■ UART lines
 ■ PWM lines

8.1 mikroBUS™ pinout

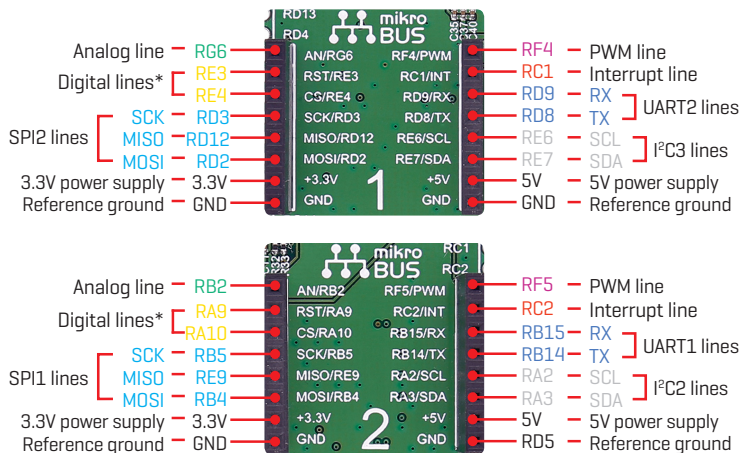

Figure 9-1: mikroBUS™ individual and shared lines

■ Digital lines
 ■ Analog Lines
 ■ Interrupt Lines
 ■ SPI Lines
 ■ I2C Lines
 ■ UART lines
 ■ PWM lines

9. click boards™ are plug and play!

Up to now, MikroElektronika has released more than 300 mikroBUS™ compatible click boards™. On the average, three click boards are released per week. It is our intention to provide you with as many add-on boards as possible, so you will be able to expand your development board with additional functionality. Each board comes with a set of working example code. Please visit the click boards™ webpage for the complete list of currently available boards:

<https://shop.mikroe.com/click>

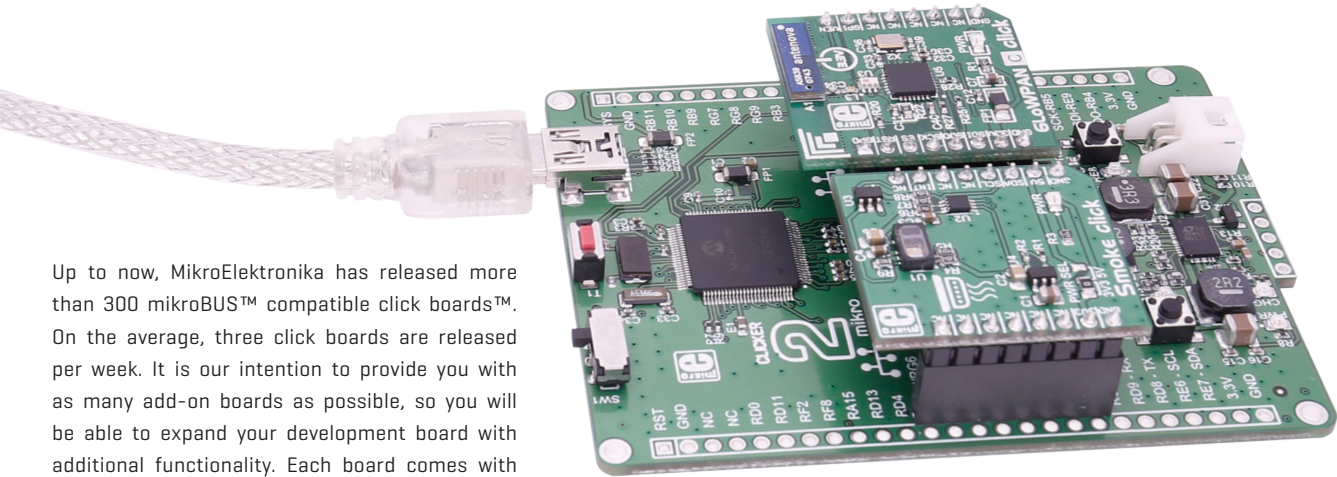
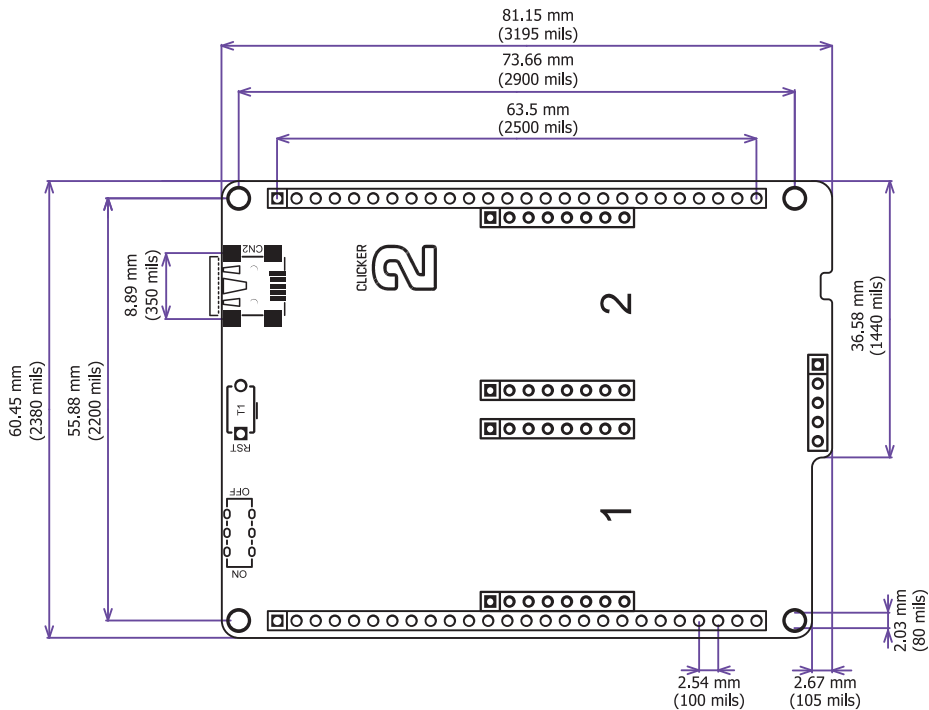

Figure 10-1:
clicker 2 for PIC24 driving
click boards™

10. Dimensions



DISCLAIMER

All the products owned by MikroElektronika are protected by copyright law and international copyright treaty. Therefore, this manual is to be treated as any other copyright material. No part of this manual, including product and software described herein, may be reproduced, stored in a retrieval system, translated or transmitted in any form or by any means, without the prior written permission of MikroElektronika. The manual PDF edition can be printed for private or local use, but not for distribution. Any modification of this manual is prohibited.

MikroElektronika provides this manual 'as is' without warranty of any kind, either expressed or implied, including, but not limited to, the implied warranties or conditions of merchantability or fitness for a particular purpose.

MikroElektronika shall assume no responsibility or liability for any errors, omissions and inaccuracies that may appear in this manual. In no event shall MikroElektronika, its directors, officers, employees or distributors be liable for any indirect, specific, incidental or consequential damages (including damages for loss of business profits and business information, business interruption or any other pecuniary loss) arising out of the use of this manual or product, even if MikroElektronika has been advised of the possibility of such damages. MikroElektronika reserves the right to change information contained in this manual at any time without prior notice, if necessary.

HIGH RISK ACTIVITIES

The products of MikroElektronika are not fault – tolerant nor designed, manufactured or intended for use or resale as on – line control equipment in hazardous environments requiring fail – safe performance, such as in the operation of nuclear facilities, aircraft navigation or communication systems, air traffic control, direct life support machines or weapons systems in which the failure of Software could lead directly to death, personal injury or severe physical or environmental damage ['High Risk Activities']. MikroElektronika and its suppliers specifically disclaim any expressed or implied warranty of fitness for High Risk Activities.

TRADEMARKS

The MikroElektronika name and logo, mikroC, mikroBasic, mikroPascal, Visual TFT, Visual GLCD, mikroProg, Ready, MINI, mikroBUS™, EasyPIC, EasyAVR, Easy8051, click boards™ and mikromedia are trademarks of MikroElektronika. All other trademarks mentioned herein are property of their respective companies.

All other product and corporate names appearing in this manual may or may not be registered trademarks or copyrights of their respective companies, and are only used for identification or explanation and to the owners' benefit, with no intent to infringe.

Copyright © 2017 MikroElektronika. All Rights Reserved.



If you want to learn more about our products, please visit our web site at www.mikroe.com

If you are experiencing some problems with any of our products or just need additional information, please place your ticket at helpdesk.mikroe.com

If you have any questions, comments or business proposals,
do not hesitate to contact us at office@mikroe.com