

APPROVED: \_\_\_\_\_

DATE: \_\_\_\_\_ TITLE: \_\_\_\_\_

Rev	AWO #	Description	Date	Appr
-		RELEASED	5/6/20	
A		UPDATE DRAWING	10/27/21	WX/AY1
B		UPDATE DRAWING	2/3/23	JJ/AC1

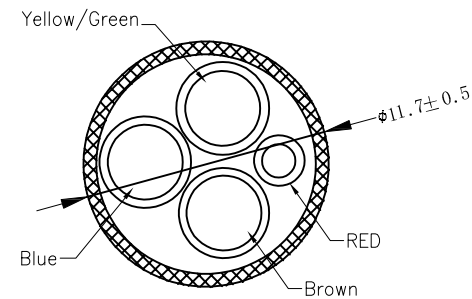
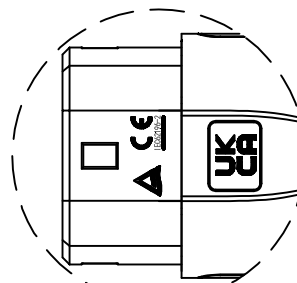
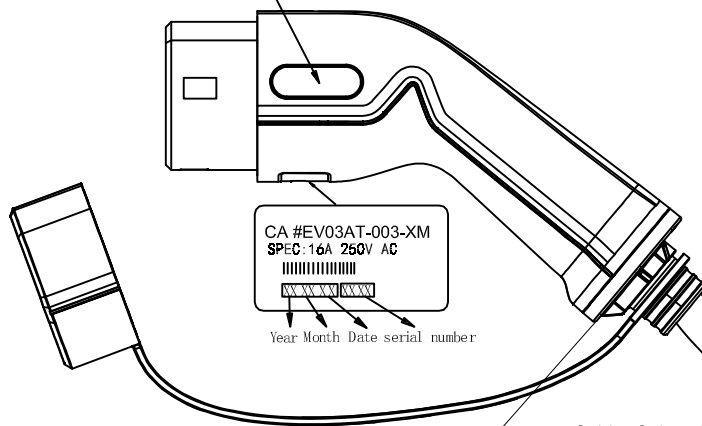
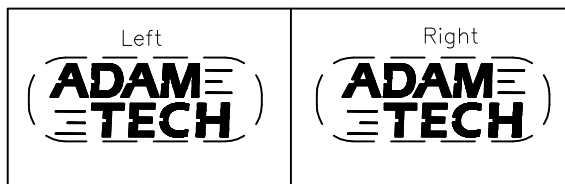
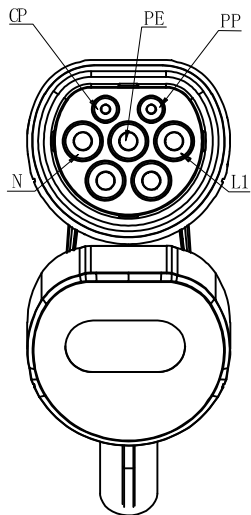

SECTION A-A

CA #EV03AT-003-XM  
SPEC: 16A 250V AC  
Year Month Date serial number

Cable Color: Black

Heat-shrinkable tubing OD=18.6±1mm

(Outlet length X-200 ±80mm)

Stripping Length Units 200 ±10mm

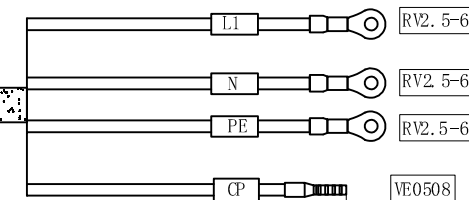

SPECIFICATIONS:

Material: PC, PA66, Glass reinforced, Thermoplastic, rated UL 94V-0  
Insulator color: White

Contacts: Copper Alloy, Silver plated surface

Electrical:  
Current rating: 16A  
Voltage rating: 250 VAC  
Insulation resistance: 500 Mohms min  
Dielectric withstanding voltage: 2,000VAC

Mechanical:  
Mechanical life: unloaded plugged: >10,000  
Insertion and Extraction Force: <100N  
Temperature Rating:  
-30°C to +50°C

Environmental:  
Waterproof grade: IP54  
Lead free, RoHS compliant

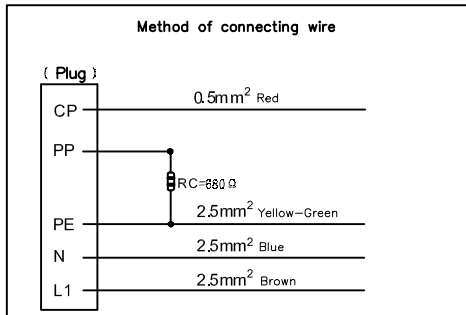

ADAM TECH P/N	LENGTH
CA #EV03AT-003-3M	3,000mm ±30mm
CA #EV03AT-003-5M	5,000mm ±30mm

Charging plug: according to IEC62196-1 2014, IEC62196-2 2017 standard  
Charging cable: 3G2.5mm<sup>2</sup>+1x0.5mm<sup>2</sup> (outer leather material TPU)

UNLESS OTHERWISE SPECIFIED ALL DIMENSIONS ARE MILLIMETERS. TOLERANCES: EXCEPT AS NOTED			909 Rahway Avenue, Union, NJ 07083 Phone: 908-687-5000 Fax: 908-687-5710	
DRAWN	OW	5/6/20	TITLE CABLE ASSEMBLY EV CHARGER	
CHECKED	AC	5/6/20	TYPE 2 FEMALE PLUG 16A 1PHASE 2.5MM <sup>2</sup> TUV	
APPROVED			SIZE X	PART NO. CA #EV03AT-003-XM
THIS DRAWING CONTAINS INFORMATION THAT IS PROPRIETARY AND SHOULD NOT BE USED WITHOUT PRIOR WRITTEN PERMISSION FROM ADAM TECH			REV. B	
REF:	S00199C	SCALE: NTS	SHEET 1 OF 1	