

Fast Avalanche SMD Rectifier

SMA (DO-214AC)

 Cathode  Anode

ADDITIONAL RESOURCES

[3D Models](#)

PRIMARY CHARACTERISTICS	
$I_{F(AV)}$	1.5 A
V_{RRM}	200 V, 400 V, 600 V
I_{FSM}	30 A
I_R	1.0 μ A
V_F	1.25 V
t_{rr}	140 ns
E_R	20 mJ
T_J max.	150 °C
Package	SMA (DO-214AC)
Circuit configuration	Single

FEATURES

- Low profile package
- Ideal for automated placement
- Glass passivated junction
- Low reverse current
- Soft recovery characteristics
- Fast reverse recovery time
- Meets MSL level 1, per J-STD-020, LF maximum peak of 260 °C
- AEC-Q101 qualified available
- Automotive ordering code P/NHE3 or P/NHM3
- Material categorization: for definitions of compliance please see www.vishay.com/doc?99912

RoHS
COMPLIANT
HALOGEN
FREE

TYPICAL APPLICATIONS

For use in high frequency rectification and freewheeling application in switching mode converters and inverters for consumer, computer, automotive, and telecommunication.

MECHANICAL DATA

Case: SMA (DO-214AC)

Molding compound meets UL 94 V-0 flammability rating
Base P/N-E3 - RoHS-compliant, commercial grade
Base P/N-M3 - halogen-free, RoHS-compliant, and commercial grade

Base P/NHE3_X - RoHS-compliant, and AEC-Q101 qualified
Base P/NHM3_X - halogen-free, RoHS-compliant and AEC-Q101 qualified

("_X" denotes revision code e.g. A, B,...)

Terminals: matte tin plated leads, solderable per J-STD-002 and JESD 22-B102

E3, M3, HE3, and HM3 suffix meet JESD 201 class 2 whisker test

Polarity: color band denotes the cathode end

MAXIMUM RATINGS ($T_A = 25\text{ °C}$ unless otherwise noted)					
PARAMETER	SYMBOL	BYG24D	BYG24G	BYG24J	UNIT
Device marking code		BYG24D	BYG24G	BYG24J	
Maximum repetitive peak reverse voltage	V_{RRM}	200	400	600	V
Average forward current at $T_A = 65\text{ °C}$	$I_{F(AV)}$	1.5			A
Peak forward surge current 10 ms single half sine-wave superimposed on rated load	I_{FSM}	30			A
Pulse energy in avalanche mode, non repetitive (inductive load switch off) $I_{(BR)R} = 1\text{ A}$, $T_J = 25\text{ °C}$	E_R	20			mJ
Operating junction and storage temperature range	T_J, T_{STG}	-55 to +150			°C



ELECTRICAL CHARACTERISTICS ($T_A = 25\text{ }^\circ\text{C}$ unless otherwise noted)						
PARAMETER	TEST CONDITIONS	SYMBOL	BYG24D	BYG24G	BYG24J	UNIT
Minimum breakdown voltage	$I_R = 100\text{ }\mu\text{A}$	V_{BR}	200	400	600	V
Maximum instantaneous forward voltage	$I_F = 1\text{ A}$	$T_J = 25\text{ }^\circ\text{C}$	$V_F^{(1)}$	1.15		V
	$I_F = 1.5\text{ A}$			1.25		
Maximum reverse current	$V_R = V_{RRM}$	$T_J = 25\text{ }^\circ\text{C}$	1		μA	
		$T_J = 100\text{ }^\circ\text{C}$	10			
Maximum reverse recovery time	$I_F = 0.5\text{ A}, I_R = 1.0\text{ A}, I_{rr} = 0.25\text{ A}$	t_{rr}	140		ns	

Note

(1) Pulse test: 300 μs pulse width, 1 % duty cycle

THERMAL CHARACTERISTICS ($T_A = 25\text{ }^\circ\text{C}$ unless otherwise noted)					
PARAMETER	SYMBOL	BYG24D	BYG24G	BYG24J	UNIT
Junction to case	$R_{\theta JC}$	25			$^\circ\text{C/W}$
Maximum thermal resistance, junction to ambient	$R_{\theta JA}^{(1)}$	150			$^\circ\text{C/W}$
	$R_{\theta JA}^{(2)}$	125			

Notes

(1) Mounted on epoxy-glass hard tissue 35 μm x 17 mm^2 cooper area per electrode

(2) Mounted on epoxy-glass hard tissue 35 μm x 50 mm^2 cooper area per electrode

ORDERING INFORMATION (Example)				
PREFERRED P/N	UNIT WEIGHT (g)	PREFERRED PACKAGE CODE	BASE QUANTITY	DELIVERY MODE
BYG24D-E3/TR	0.064	TR	1800	7" diameter plastic tape and reel
BYG24D-E3/TR3	0.064	TR3	7500	13" diameter plastic tape and reel
BYG24DHE3_A/H ⁽¹⁾	0.064	H	1800	7" diameter plastic tape and reel
BYG24DHE3_A/I ⁽¹⁾	0.064	I	7500	13" diameter plastic tape and reel
BYG24D-M3/TR	0.064	TR	1800	7" diameter plastic tape and reel
BYG24D-M3/TR3	0.064	TR3	7500	13" diameter plastic tape and reel
BYG24DHM3_A/H ⁽¹⁾	0.064	H	1800	7" diameter plastic tape and reel
BYG24DHM3_A/I ⁽¹⁾	0.064	I	7500	13" diameter plastic tape and reel

Note

(1) AEC-Q101 qualified

RATINGS AND CHARACTERISTICS CURVES ($T_A = 25\text{ }^\circ\text{C}$ unless otherwise noted)

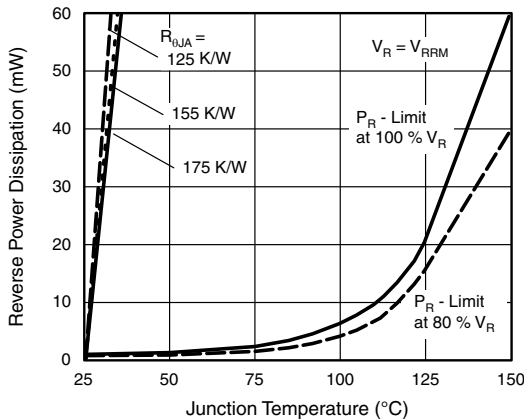

Fig. 1 - Max. Reverse Power Dissipation vs. Junction Temperature

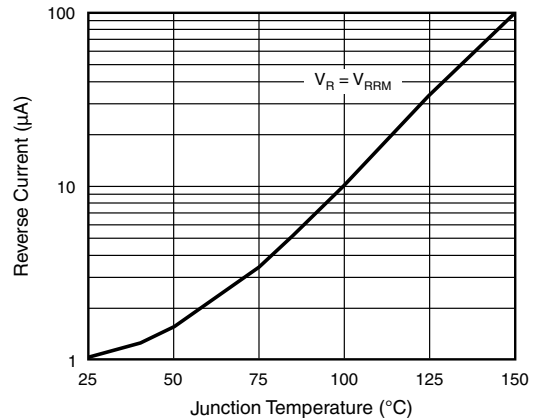

Fig. 2 - Reverse Current vs. Junction Temperature

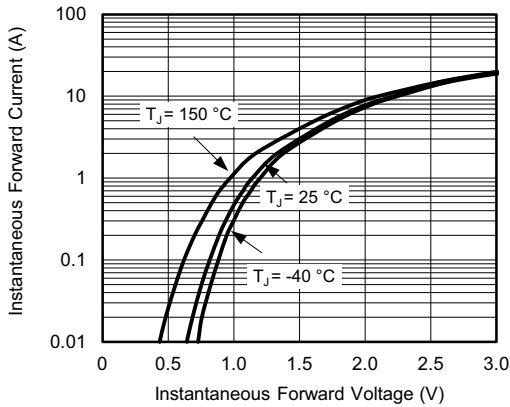

Fig. 3 - Forward Current vs. Forward Voltage

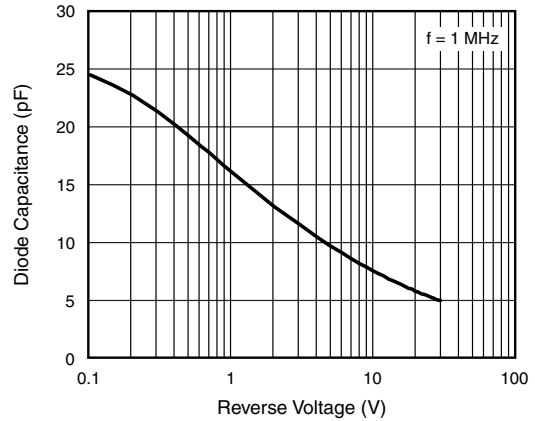

Fig. 5 - Diode Capacitance vs. Reverse Voltage

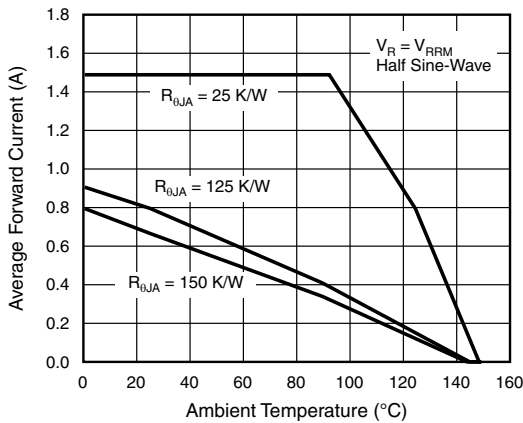
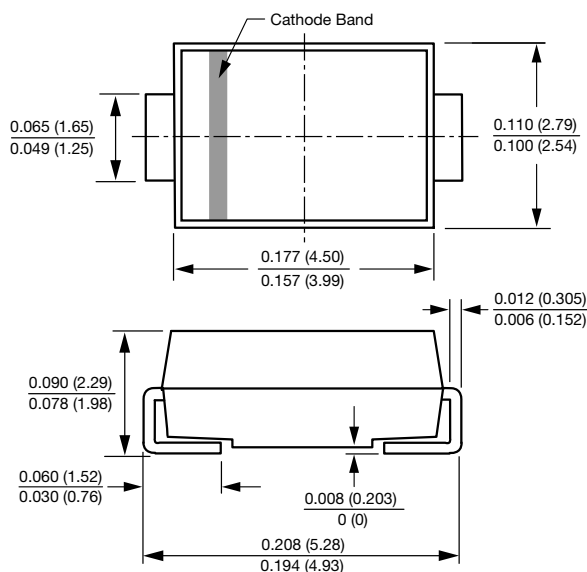

Fig. 4 - Average Forward Current vs. Ambient Temperature

PACKAGE OUTLINE DIMENSIONS in inches (millimeters)

SMA (DO-214AC)



Mounting Pad Layout

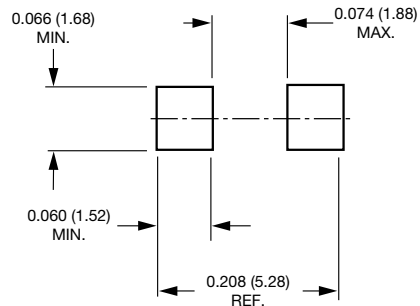



Disclaimer

ALL PRODUCT, PRODUCT SPECIFICATIONS AND DATA ARE SUBJECT TO CHANGE WITHOUT NOTICE TO IMPROVE RELIABILITY, FUNCTION OR DESIGN OR OTHERWISE.

Vishay Intertechnology, Inc., its affiliates, agents, and employees, and all persons acting on its or their behalf (collectively, "Vishay"), disclaim any and all liability for any errors, inaccuracies or incompleteness contained in any datasheet or in any other disclosure relating to any product.

Vishay makes no warranty, representation or guarantee regarding the suitability of the products for any particular purpose or the continuing production of any product. To the maximum extent permitted by applicable law, Vishay disclaims (i) any and all liability arising out of the application or use of any product, (ii) any and all liability, including without limitation special, consequential or incidental damages, and (iii) any and all implied warranties, including warranties of fitness for particular purpose, non-infringement and merchantability.

Statements regarding the suitability of products for certain types of applications are based on Vishay's knowledge of typical requirements that are often placed on Vishay products in generic applications. Such statements are not binding statements about the suitability of products for a particular application. It is the customer's responsibility to validate that a particular product with the properties described in the product specification is suitable for use in a particular application. Parameters provided in datasheets and / or specifications may vary in different applications and performance may vary over time. All operating parameters, including typical parameters, must be validated for each customer application by the customer's technical experts. Product specifications do not expand or otherwise modify Vishay's terms and conditions of purchase, including but not limited to the warranty expressed therein.

Hyperlinks included in this datasheet may direct users to third-party websites. These links are provided as a convenience and for informational purposes only. Inclusion of these hyperlinks does not constitute an endorsement or an approval by Vishay of any of the products, services or opinions of the corporation, organization or individual associated with the third-party website. Vishay disclaims any and all liability and bears no responsibility for the accuracy, legality or content of the third-party website or for that of subsequent links.

Except as expressly indicated in writing, Vishay products are not designed for use in medical, life-saving, or life-sustaining applications or for any other application in which the failure of the Vishay product could result in personal injury or death. Customers using or selling Vishay products not expressly indicated for use in such applications do so at their own risk. Please contact authorized Vishay personnel to obtain written terms and conditions regarding products designed for such applications.

No license, express or implied, by estoppel or otherwise, to any intellectual property rights is granted by this document or by any conduct of Vishay. Product names and markings noted herein may be trademarks of their respective owners.