

# BU323Z

## NPN Silicon Power Darlington

### High Voltage Autoprotected

The BU323Z is a planar, monolithic, high-voltage power Darlington with a built-in active zener clamping circuit. This device is specifically designed for unclamped, inductive applications such as Electronic Ignition, Switching Regulators and Motor Control, and exhibit the following main features:

#### Features

- Integrated High-Voltage Active Clamp
- Tight Clamping Voltage Window (350 V to 450 V) Guaranteed Over the  $-40^{\circ}\text{C}$  to  $+125^{\circ}\text{C}$  Temperature Range
- Clamping Energy Capability 100% Tested in a Live Ignition Circuit
- High DC Current Gain/Low Saturation Voltages Specified Over Full Temperature Range
- Design Guarantees Operation in SOA at All Times
- Offered in Plastic SOT-93/TO-218 Type or TO-220 Packages
- Pb-Free Packages are Available\*

#### MAXIMUM RATINGS

Rating	Symbol	Max	Unit
Collector-Emitter Sustaining Voltage	$V_{CEO}$	350	Vdc
Collector-Emitter Voltage	$V_{EBO}$	6.0	Vdc
Collector Current – Continuous – Peak	$I_C$ $I_{CM}$	10 20	Adc
Base Current – Continuous – Peak	$I_B$ $I_{BM}$	3.0 6.0	Adc
Total Power Dissipation @ $T_C = 25^{\circ}\text{C}$ Derate above $25^{\circ}\text{C}$	$P_D$	150 1.0	W W/ $^{\circ}\text{C}$
Operating and Storage Junction Temperature Range	$T_J, T_{stg}$	$-65$ to $+175$	$^{\circ}\text{C}$

#### THERMAL CHARACTERISTICS

Characteristic	Symbol	Max	Unit
Thermal Resistance, Junction-to-Case	$R_{\theta JC}$	1.0	$^{\circ}\text{C}/\text{W}$
Maximum Lead Temperature for Soldering Purposes: 1/8" from Case for 5 Seconds	$T_L$	260	$^{\circ}\text{C}$

Stresses exceeding Maximum Ratings may damage the device. Maximum Ratings are stress ratings only. Functional operation above the Recommended Operating Conditions is not implied. Extended exposure to stresses above the Recommended Operating Conditions may affect device reliability.

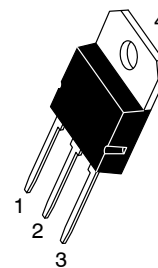
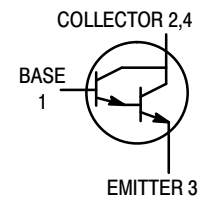
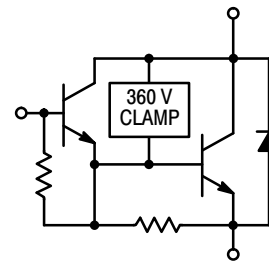
\*For additional information on our Pb-Free strategy and soldering details, please download the ON Semiconductor Soldering and Mounting Techniques Reference Manual, SOLDERRM/D.



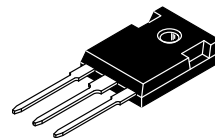
ON Semiconductor®

<http://onsemi.com>

### 10 AMPERE DARLINGTON AUTOPROTECTED 360 – 450 VOLTS CLAMP, 150 WATTS



SOT-93  
CASE 340D  
STYLE 1



TO-247  
CASE 340L  
STYLE 3

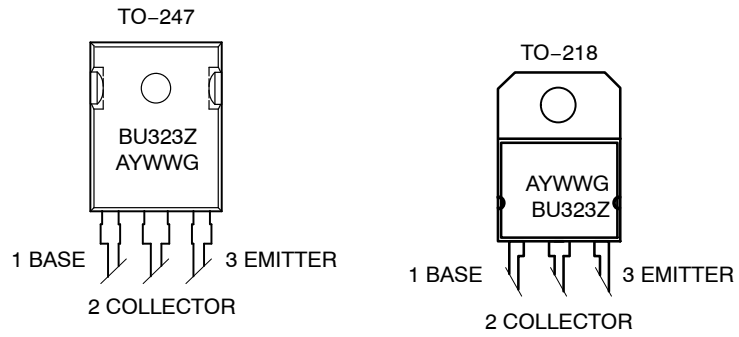
**NOTE: Effective June 2012 this device will be available only in the TO-247 package. Reference FPCN# 16827.**

#### ORDERING INFORMATION

See detailed ordering and shipping information in the package dimensions section on page 2 of this data sheet.

# BU323Z

## MARKING DIAGRAMS



BU323Z = Device Code  
A = Assembly Location  
Y = Year  
WW = Work Week  
G = Pb-Free Package

## ORDERING INFORMATION

Device Order Number	Package Type	Shipping
BU323ZG	TO-218 (Pb-Free)	30 Units / Rail
BU323ZG	TO-247 (Pb-Free)	30 Units / Rail

# BU323Z

## ELECTRICAL CHARACTERISTICS ( $T_C = 25^\circ\text{C}$ unless otherwise noted)

Characteristic	Symbol	Min	Typ	Max	Unit
<b>OFF CHARACTERISTICS (1)</b>					
Collector–Emitter Clamping Voltage ( $I_C = 7.0\text{ A}$ ) ( $T_C = -40^\circ\text{C}$ to $+125^\circ\text{C}$ )	$V_{CLAMP}$	350	–	450	Vdc
Collector–Emitter Cutoff Current ( $V_{CE} = 200\text{ V}$ , $I_B = 0$ )	$I_{CEO}$	–	–	100	$\mu\text{Adc}$
Emitter–Base Leakage Current ( $V_{EB} = 6.0\text{ Vdc}$ , $I_C = 0$ )	$I_{EBO}$	–	–	50	$\text{mAdc}$

## ON CHARACTERISTICS (1)

Base–Emitter Saturation Voltage ( $I_C = 8.0\text{ Adc}$ , $I_B = 100\text{ mAdc}$ ) ( $I_C = 10\text{ Adc}$ , $I_B = 0.25\text{ Adc}$ )	$V_{BE(sat)}$	– –	– –	2.2 2.5	Vdc
Collector–Emitter Saturation Voltage ( $I_C = 7.0\text{ Adc}$ , $I_B = 70\text{ mAdc}$ )  ( $I_C = 8.0\text{ Adc}$ , $I_B = 0.1\text{ Adc}$ )  ( $I_C = 10\text{ Adc}$ , $I_B = 0.25\text{ Adc}$ )	$V_{CE(sat)}$	– – – –	– – – –	1.6 1.8 1.8 2.1 1.7	Vdc
Base–Emitter On Voltage ( $I_C = 5.0\text{ Adc}$ , $V_{CE} = 2.0\text{ Vdc}$ ) ( $I_C = 8.0\text{ Adc}$ , $V_{CE} = 2.0\text{ Vdc}$ )	$V_{BE(on)}$	1.1 1.3	– –	2.1 2.3	Vdc
Diode Forward Voltage Drop ( $I_F = 10\text{ Adc}$ )	$V_F$	–	–	2.5	Vdc
DC Current Gain ( $I_C = 6.5\text{ Adc}$ , $V_{CE} = 1.5\text{ Vdc}$ ) ( $I_C = 5.0\text{ Adc}$ , $V_{CE} = 4.6\text{ Vdc}$ )	$h_{FE}$	150 500	– –	– 3400	–

## DYNAMIC CHARACTERISTICS

Current Gain Bandwidth ( $I_C = 0.2\text{ Adc}$ , $V_{CE} = 10\text{ Vdc}$ , $f = 1.0\text{ MHz}$ )	$f_T$	–	–	2.0	MHz
Output Capacitance ( $V_{CB} = 10\text{ Vdc}$ , $I_E = 0$ , $f = 1.0\text{ MHz}$ )	$C_{ob}$	–	–	200	pF
Input Capacitance ( $V_{EB} = 6.0\text{ V}$ )	$C_{ib}$	–	–	550	pF

## CLAMPING ENERGY (see notes)

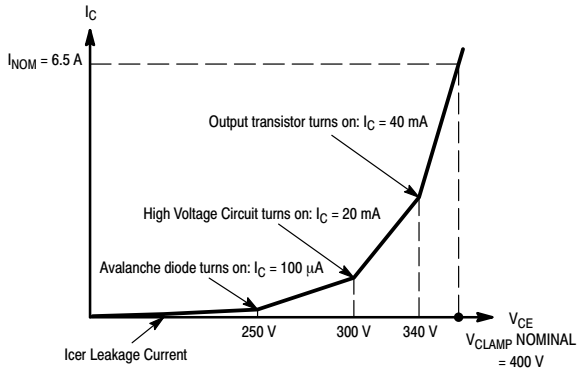
Repetitive Non–Destructive Energy Dissipated at turn–off: ( $I_C = 7.0\text{ A}$ , $L = 8.0\text{ mH}$ , $R_{BE} = 100\ \Omega$ ) (see Figures 2 and 4)	$W_{CLAMP}$	200	–	–	mJ
--	-------------	-----	---	---	----

## SWITCHING CHARACTERISTICS: Inductive Load ( $L = 10\text{ mH}$ )

Fall Time	( $I_C = 6.5\text{ A}$ , $I_{B1} = 45\text{ mA}$ , $V_{BE(off)} = 0$ , $R_{BE(off)} = 0$ , $V_{CC} = 14\text{ V}$ , $V_Z = 300\text{ V}$ )	$t_{fi}$	–	625	–	ns
Storage Time		$t_{si}$	–	10	30	$\mu\text{s}$
Cross–over Time		$t_c$	–	1.7	–	$\mu\text{s}$

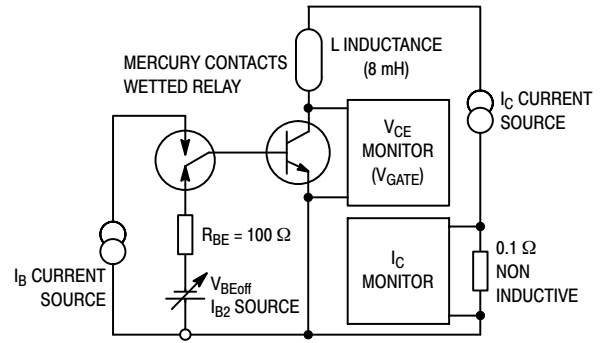
1. Pulse Test: Pulse Width  $\leq 300\ \mu\text{s}$ , Duty Cycle = 2.0%.

# BU323Z



**Figure 1.  $I_C = f(V_{CE})$  Curve Shape**

By design, the BU323Z has a built-in avalanche diode and a special high voltage driving circuit. During an auto-protect cycle, the transistor is turned on again as soon as a voltage, determined by the zener threshold and the network, is reached. This prevents the transistor from going into a Reverse Bias Operating limit condition. Therefore, the device will have an extended safe operating area and will always appear to be in "FBSOA." Because of the built-in zener and associated network, the  $I_C = f(V_{CE})$  curve exhibits an unfamiliar shape compared to standard products as shown in Figure 1.

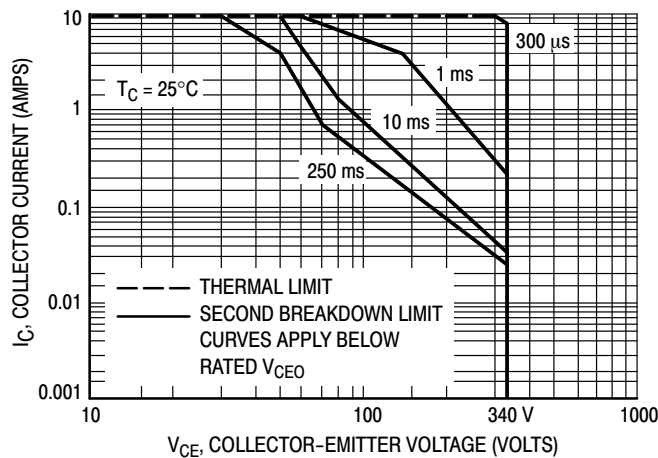


**Figure 2. Basic Energy Test Circuit**

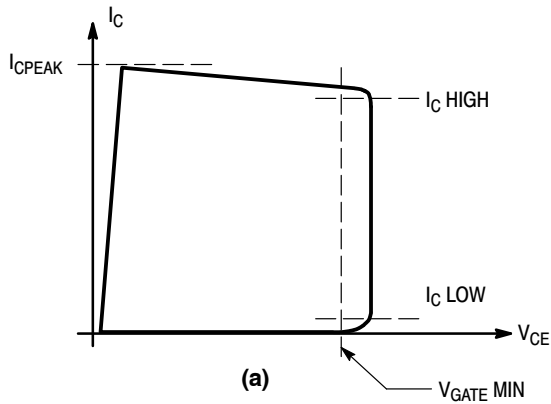
The bias parameters,  $V_{CLAMP}$ ,  $I_{B1}$ ,  $V_{BE(off)}$ ,  $I_{B2}$ ,  $I_C$ , and the inductance, are applied according to the Device Under Test (DUT) specifications.  $V_{CE}$  and  $I_C$  are monitored by the test system while making sure the load line remains within the limits as described in Figure 4.

Note: All BU323Z ignition devices are 100% energy tested, per the test circuit and criteria described in Figures 2 and 4, to the minimum guaranteed repetitive energy, as specified in the device parameter section. The device can sustain this energy on a repetitive basis without degrading any of the specified electrical characteristics of the devices. The units under test are kept functional during the complete test sequence for the test conditions described:

$I_{C(peak)} = 7.0 \text{ A}$ ,  $I_{CH} = 5.0 \text{ A}$ ,  $I_{CL} = 100 \text{ mA}$ ,  $I_B = 100 \text{ mA}$ ,  $R_{BE} = 100 \text{ } \Omega$ ,  $V_{gate} = 280 \text{ V}$ ,  $L = 8.0 \text{ mH}$

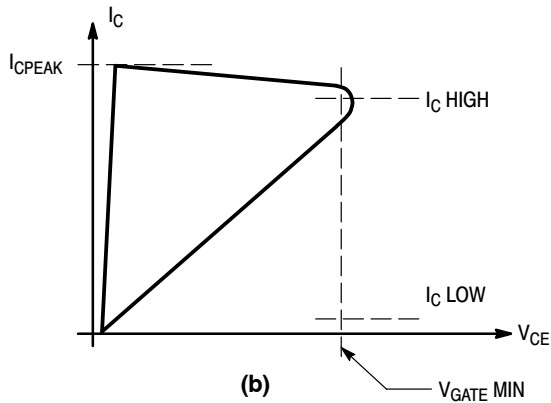


**Figure 3. Forward Bias Safe Operating Area**

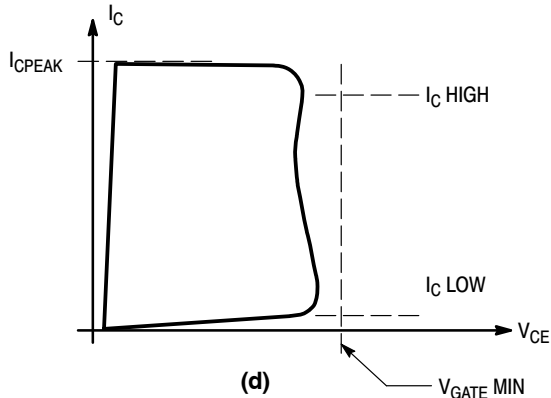
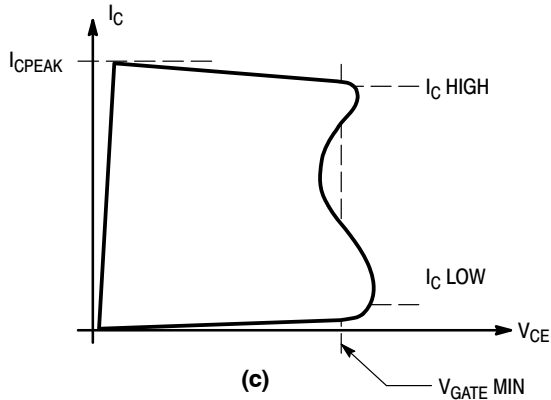


The shaded area represents the amount of energy the device can sustain, under given DC biases ( $I_C/I_B/V_{BE(off)}/R_{BE}$ ), without an external clamp; see the test schematic diagram, Figure 2.

The transistor **PASSES** the Energy test if, for the inductive load and  $I_{CPEAK}/I_B/V_{BE(off)}$  biases, the  $V_{CE}$  remains outside the shaded area and greater than the  $V_{GATE}$  minimum limit, Figure 4a.



The transistor **FAILS** if the  $V_{CE}$  is less than the  $V_{GATE}$  (minimum limit) at any point along the  $V_{CE}/I_C$  curve as shown on Figures 4b, and 4c. This assures that hot spots and uncontrolled avalanche are not being generated in the die, and the transistor is not damaged, thus enabling the sustained energy level required.



The transistor **FAILS** if its Collector/Emitter breakdown voltage is less than the  $V_{GATE}$  value, Figure 4d.

Figure 4. Energy Test Criteria for BU323Z

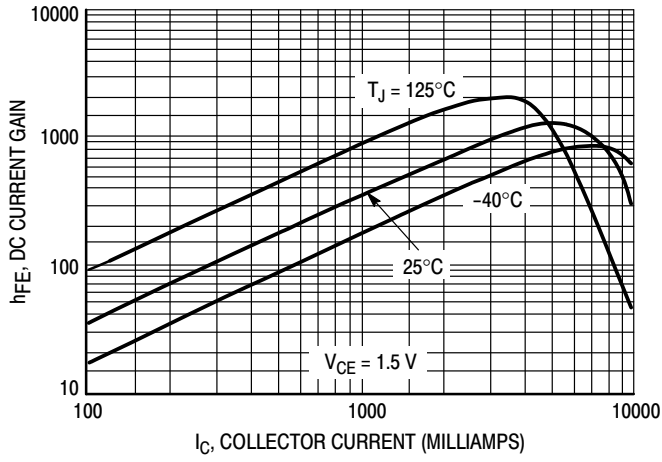


Figure 5. DC Current Gain

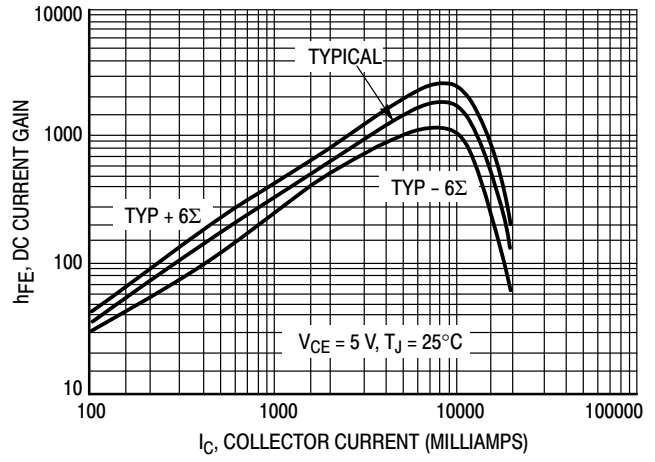


Figure 6. DC Current Gain

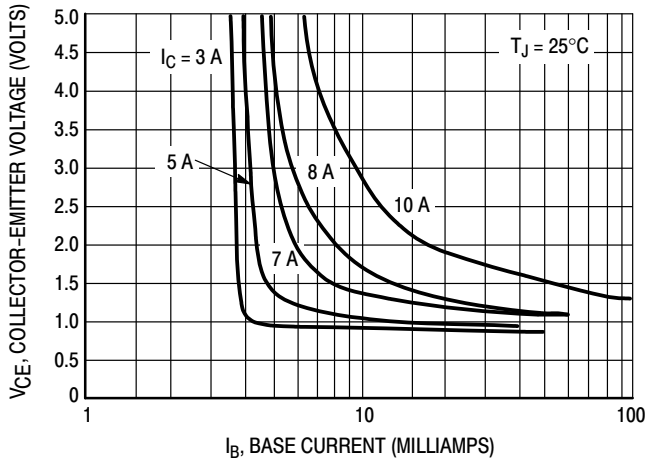


Figure 7. Collector Saturation Region

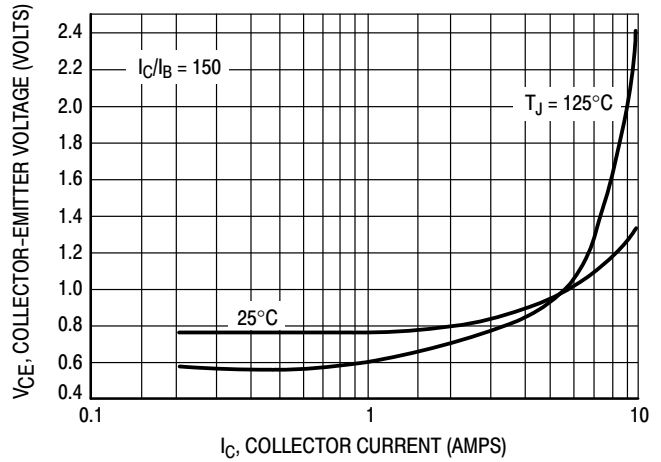


Figure 8. Collector-Emmitter Saturation Voltage

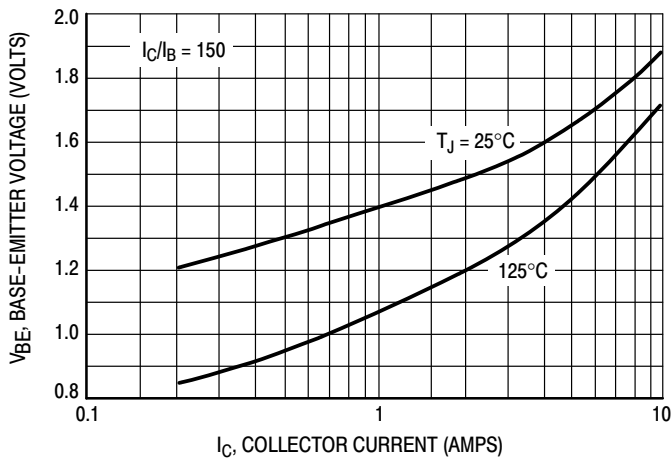


Figure 9. Base-Emmitter Saturation Voltage

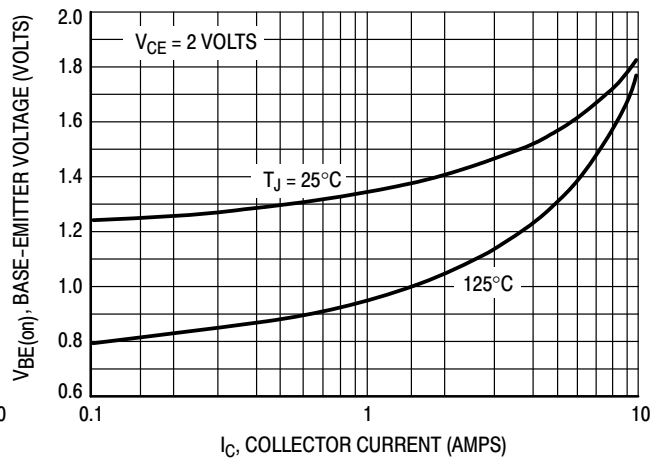


Figure 10. Base-Emmitter "ON" Voltages

# MECHANICAL CASE OUTLINE

## PACKAGE DIMENSIONS

ON Semiconductor®

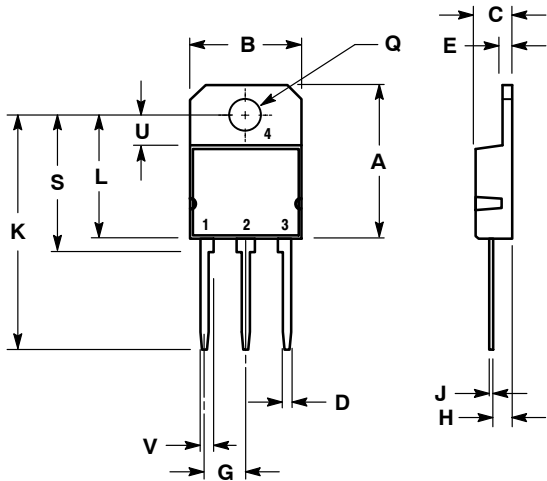


### SOT-93 (TO-218) CASE 340D-02 ISSUE E

DATE 01/03/2002



SCALE 1:1



STYLE 1:  
PIN 1. BASE  
2. COLLECTOR  
3. EMITTER  
4. COLLECTOR

STYLE 2:  
PIN 1. ANODE  
2. CATHODE  
3. ANODE  
4. CATHODE

- NOTES:  
1. DIMENSIONING AND TOLERANCING PER ANSI Y14.5M, 1982.  
2. CONTROLLING DIMENSION: MILLIMETER.

DIM	MILLIMETERS		INCHES	
	MIN	MAX	MIN	MAX
A	---	20.35	---	0.801
B	14.70	15.20	0.579	0.598
C	4.70	4.90	0.185	0.193
D	1.10	1.30	0.043	0.051
E	1.17	1.37	0.046	0.054
G	5.40	5.55	0.213	0.219
H	2.00	3.00	0.079	0.118
J	0.50	0.78	0.020	0.031
K	31.00 REF		1.220 REF	
L	---	16.20	---	0.638
Q	4.00	4.10	0.158	0.161
S	17.80	18.20	0.701	0.717
U	4.00 REF		0.157 REF	
V	1.75 REF		0.069	

### MARKING DIAGRAM

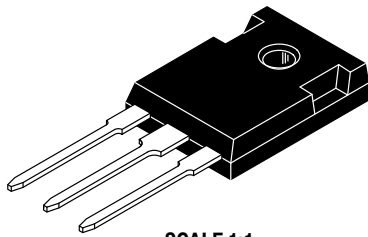


A = Assembly Location  
Y = Year  
WW = Work Week  
xxxxx = Device Code

DOCUMENT NUMBER:	98ASB42643B	Electronic versions are uncontrolled except when accessed directly from the Document Repository. Printed versions are uncontrolled except when stamped "CONTROLLED COPY" in red.
DESCRIPTION:	SOT-93	PAGE 1 OF 1

ON Semiconductor and are trademarks of Semiconductor Components Industries, LLC dba ON Semiconductor or its subsidiaries in the United States and/or other countries. ON Semiconductor reserves the right to make changes without further notice to any products herein. ON Semiconductor makes no warranty, representation or guarantee regarding the suitability of its products for any particular purpose, nor does ON Semiconductor assume any liability arising out of the application or use of any product or circuit, and specifically disclaims any and all liability, including without limitation special, consequential or incidental damages. ON Semiconductor does not convey any license under its patent rights nor the rights of others.

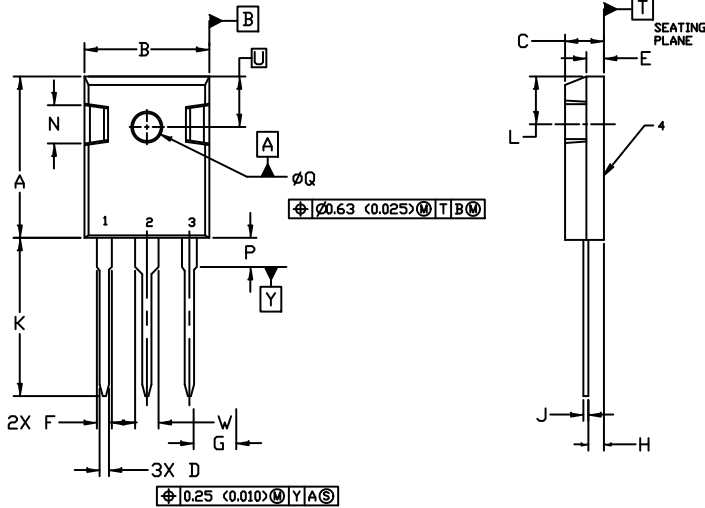
# MECHANICAL CASE OUTLINE PACKAGE DIMENSIONS



TO-247  
CASE 340L  
ISSUE G

DATE 06 OCT 2021

SCALE 1:1

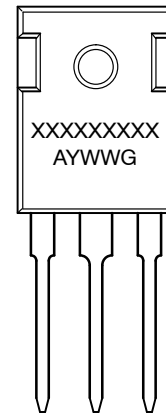


NOTES:

1. DIMENSIONING AND TOLERANCING PER ASME Y14.5M, 1982.
2. CONTROLLING DIMENSION: MILLIMETER

DIM	MILLIMETERS		INCHES	
	MIN.	MAX.	MIN.	MAX.
A	20.32	21.08	0.800	0.830
B	15.75	16.26	0.620	0.640
C	4.70	5.30	0.185	0.209
D	1.00	1.40	0.040	0.055
E	1.90	2.60	0.075	0.102
F	1.65	2.13	0.065	0.084
G	5.45 BSC		0.215 BSC	
H	1.50	2.49	0.059	0.098
J	0.40	0.80	0.016	0.031
K	19.81	20.83	0.780	0.820
L	5.40	6.20	0.212	0.244
N	4.32	5.49	0.170	0.216
P	----	4.50	----	0.177
Q	3.55	3.65	0.140	0.144
U	6.15 BSC		0.242 BSC	
W	2.87	3.12	0.113	0.123

GENERIC  
MARKING DIAGRAM\*



- |  |  |  |  |
|--|--|--|--|
| <p>STYLE 1:<br/>PIN 1. GATE<br/>2. DRAIN<br/>3. SOURCE<br/>4. DRAIN</p>  | <p>STYLE 2:<br/>PIN 1. ANODE<br/>2. CATHODE (S)<br/>3. ANODE 2<br/>4. CATHODES (S)</p>               | <p>STYLE 3:<br/>PIN 1. BASE<br/>2. COLLECTOR<br/>3. EMITTER<br/>4. COLLECTOR</p> | <p>STYLE 4:<br/>PIN 1. GATE<br/>2. COLLECTOR<br/>3. EMITTER<br/>4. COLLECTOR</p> |
| <p>STYLE 5:<br/>PIN 1. CATHODE<br/>2. ANODE<br/>3. GATE<br/>4. ANODE</p> | <p>STYLE 6:<br/>PIN 1. MAIN TERMINAL 1<br/>2. MAIN TERMINAL 2<br/>3. GATE<br/>4. MAIN TERMINAL 2</p> |  |  |

- XXXXXX = Specific Device Code  
A = Assembly Location  
Y = Year  
WW = Work Week  
G = Pb-Free Package

\*This information is generic. Please refer to device data sheet for actual part marking. Pb-Free indicator, "G" or microdot "▪", may or may not be present. Some products may not follow the Generic Marking.

DOCUMENT NUMBER:	98ASB15080C	Electronic versions are uncontrolled except when accessed directly from the Document Repository. Printed versions are uncontrolled except when stamped "CONTROLLED COPY" in red.
DESCRIPTION:	TO-247	PAGE 1 OF 1

onsemi and ONSEMI are trademarks of Semiconductor Components Industries, LLC dba onsemi or its subsidiaries in the United States and/or other countries. onsemi reserves the right to make changes without further notice to any products herein. onsemi makes no warranty, representation or guarantee regarding the suitability of its products for any particular purpose, nor does onsemi assume any liability arising out of the application or use of any product or circuit, and specifically disclaims any and all liability, including without limitation special, consequential or incidental damages. onsemi does not convey any license under its patent rights nor the rights of others.



**onsemi**, **Onsemi**, and other names, marks, and brands are registered and/or common law trademarks of Semiconductor Components Industries, LLC dba "**onsemi**" or its affiliates and/or subsidiaries in the United States and/or other countries. **onsemi** owns the rights to a number of patents, trademarks, copyrights, trade secrets, and other intellectual property. A listing of **onsemi**'s product/patent coverage may be accessed at [www.onsemi.com/site/pdf/Patent-Marking.pdf](http://www.onsemi.com/site/pdf/Patent-Marking.pdf). **onsemi** reserves the right to make changes at any time to any products or information herein, without notice. The information herein is provided "as-is" and **onsemi** makes no warranty, representation or guarantee regarding the accuracy of the information, product features, availability, functionality, or suitability of its products for any particular purpose, nor does **onsemi** assume any liability arising out of the application or use of any product or circuit, and specifically disclaims any and all liability, including without limitation special, consequential or incidental damages. Buyer is responsible for its products and applications using **onsemi** products, including compliance with all laws, regulations and safety requirements or standards, regardless of any support or applications information provided by **onsemi**. "Typical" parameters which may be provided in **onsemi** data sheets and/or specifications can and do vary in different applications and actual performance may vary over time. All operating parameters, including "Typicals" must be validated for each customer application by customer's technical experts. **onsemi** does not convey any license under any of its intellectual property rights nor the rights of others. **onsemi** products are not designed, intended, or authorized for use as a critical component in life support systems or any FDA Class 3 medical devices or medical devices with a same or similar classification in a foreign jurisdiction or any devices intended for implantation in the human body. Should Buyer purchase or use **onsemi** products for any such unintended or unauthorized application, Buyer shall indemnify and hold **onsemi** and its officers, employees, subsidiaries, affiliates, and distributors harmless against all claims, costs, damages, and expenses, and reasonable attorney fees arising out of, directly or indirectly, any claim of personal injury or death associated with such unintended or unauthorized use, even if such claim alleges that **onsemi** was negligent regarding the design or manufacture of the part. **onsemi** is an Equal Opportunity/Affirmative Action Employer. This literature is subject to all applicable copyright laws and is not for resale in any manner.

---

## ADDITIONAL INFORMATION

### TECHNICAL PUBLICATIONS:

Technical Library: [www.onsemi.com/design/resources/technical-documentation](http://www.onsemi.com/design/resources/technical-documentation)  
onsemi Website: [www.onsemi.com](http://www.onsemi.com)

### ONLINE SUPPORT: [www.onsemi.com/support](http://www.onsemi.com/support)

For additional information, please contact your local Sales Representative at [www.onsemi.com/support/sales](http://www.onsemi.com/support/sales)