

## Dual Common Cathode Schottky Rectifier

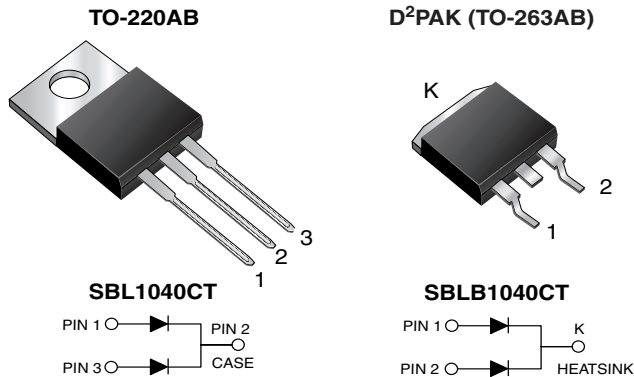

**RoHS**  
 COMPLIANT  
 HALOGEN  
**FREE**

### FEATURES

- Power pack
- Guardring for overvoltage protection
- Low power loss, high efficiency
- Low forward voltage drop
- High forward surge capability
- High frequency operation
- Meets MSL level 1, per J-STD-020, LF maximum peak of 245 °C (for D<sup>2</sup>PAK (TO-263AB) package)
- Solder bath temperature 275 °C maximum, 10 s, per JESD 22-B106 (for TO-220AB package)
- AEC-Q101 qualified
- Material categorization: for definitions of compliance please see [www.vishay.com/doc?99912](http://www.vishay.com/doc?99912)

### LINKS TO ADDITIONAL RESOURCES



### TYPICAL APPLICATIONS

For use in low voltage, high frequency rectifier of switching mode power supplies, freewheeling diodes, DC/DC converters, and polarity protection application.

PRIMARY CHARACTERISTICS	
$I_{F(AV)}$	2 x 5 A
$V_{RRM}$	40 V
$I_{FSM}$	175 A
$V_F$	0.55 V
$T_J$ max.	125 °C
Package	TO-220AB, D <sup>2</sup> PAK (TO-263AB)
Circuit configuration	Common cathode

### MECHANICAL DATA

**Case:** TO-220AB, D<sup>2</sup>PAK (TO-263AB)

TO-220AB Molding compound meets UL 94 V-0 flammability rating

Base P/N-E3 - RoHS-compliant, commercial grade

D<sup>2</sup>PAK(TO-263AB) Molding compound meets UL 94 V-0 flammability rating

Base P/N-M3 - RoHS-compliant, halogen-free, commercial grade

Base P/NHM3 - RoHS-compliant, halogen-free, AEC-Q101 qualified

**Terminals:** matte tin plated leads, solderable per J-STD-002 and JESD 22-B102

E3 and M3 suffix meets JESD 201 class 1A whisker test, HM3 suffix meets JESD 201 class 2 whisker test

**Polarity:** as marked

**Mounting Torque:** 10 in-lbs maximum



<b>MAXIMUM RATINGS</b> ( $T_C = 25\text{ }^\circ\text{C}$ unless otherwise noted)			
PARAMETER	SYMBOL	SBL1040CT	UNIT
Maximum repetitive peak reverse voltage	$V_{RRM}$	40	V
Working peak reverse voltage	$V_{RWM}$	28	
Maximum DC blocking voltage	$V_{DC}$	40	
Maximum average forward rectified current at $T_C = 107\text{ }^\circ\text{C}$	$I_{F(AV)}$	10 5.0	A
Peak forward surge current 8.3 ms single half sine-wave superimposed on rated load per diode	$I_{FSM}$	175	
Operating junction and storage temperature range	$T_J, T_{STG}$	-40 to +125	$^\circ\text{C}$

<b>ELECTRICAL CHARACTERISTICS</b> ( $T_C = 25\text{ }^\circ\text{C}$ unless otherwise noted)				
PARAMETER	SYMBOL	TEST CONDITIONS	VALUE	UNIT
Maximum instantaneous forward voltage per diode	$V_F^{(1)}$	5.0 A	0.55	V
Maximum instantaneous reverse current at DC blocking voltage per diode	$I_R^{(2)}$	Rated $V_R$	$T_C = 25\text{ }^\circ\text{C}$	0.5
			$T_C = 100\text{ }^\circ\text{C}$	50

**Notes**

- (1) Pulse test: 300  $\mu\text{s}$  pulse width, 1 % duty cycle  
(2) Pulse test: pulse width  $\leq 40\text{ ms}$

<b>THERMAL CHARACTERISTICS</b> ( $T_C = 25\text{ }^\circ\text{C}$ unless otherwise noted)				
PARAMETER	SYMBOL	SBL	SBLB	UNIT
Typical thermal resistance per diode	$R_{\theta JC}$	3.0	3.0	$^\circ\text{C/W}$

<b>ORDERING INFORMATION</b> (Example)					
PACKAGE	PREFERRED P/N	UNIT WEIGHT (g)	PACKAGE CODE	BASE QUANTITY	DELIVERY MODE
TO-220AB	SBL1040CT-E3/45	1.85	45	50/tube	Tube
TO-263AB	SBLB1040CT-M3/P	1.35	P	50/tube	Tube
TO-263AB	SBLB1040CT-M3/I	1.35	I	800/reel	Tape and reel
TO-263AB	SBLB1040CTHM3/P <sup>(1)</sup>	1.35	P	50/tube	Tube
TO-263AB	SBLB1040CTHM3/I <sup>(1)</sup>	1.35	I	800/reel	Tape and reel

**Note**

- (1) AEC-Q101 qualified, available in D<sup>2</sup>PAK (TO-263AB) package only

**RATINGS AND CHARACTERISTICS CURVES** ( $T_C = 25\text{ }^\circ\text{C}$  unless otherwise noted)

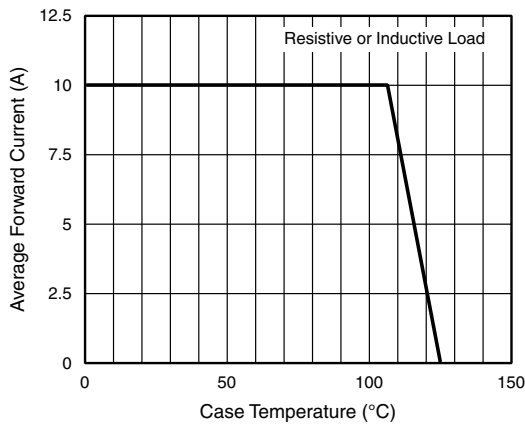

Fig. 1 - Forward Current Derating Curve

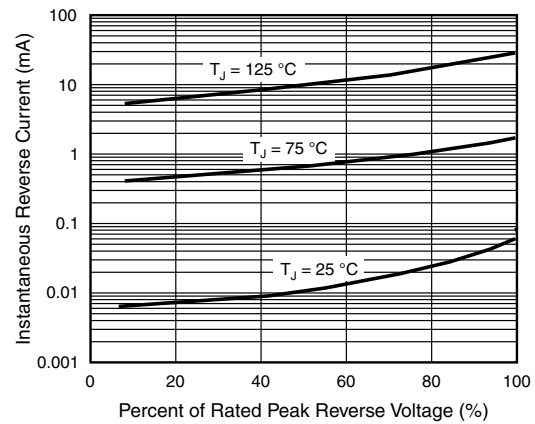

Fig. 4 - Typical Reverse Characteristics Per Diode

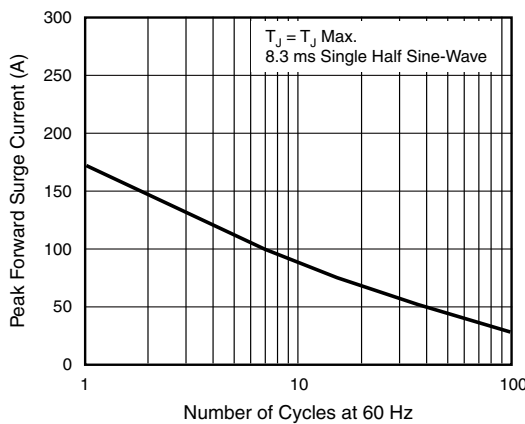

Fig. 2 - Maximum Non-Repetitive Peak Forward Surge Current Per Diode

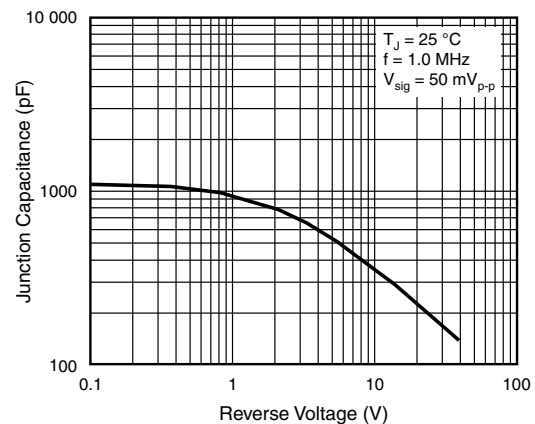

Fig. 5 - Typical Junction Capacitance Per Diode

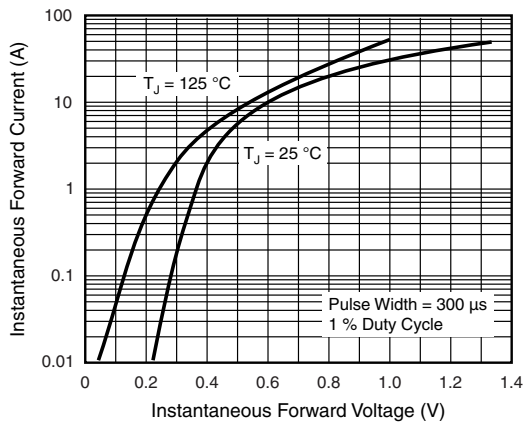

Fig. 3 - Typical Instantaneous Forward Characteristics Per Diode

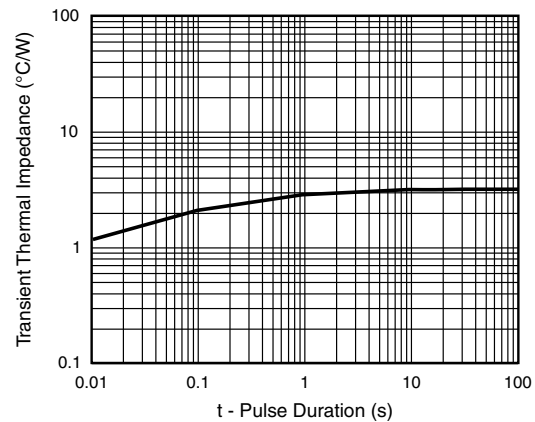
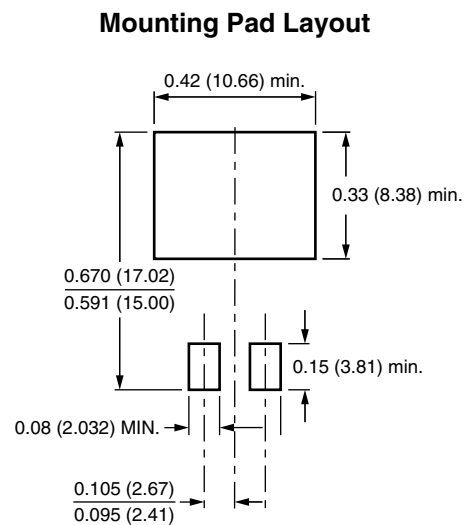
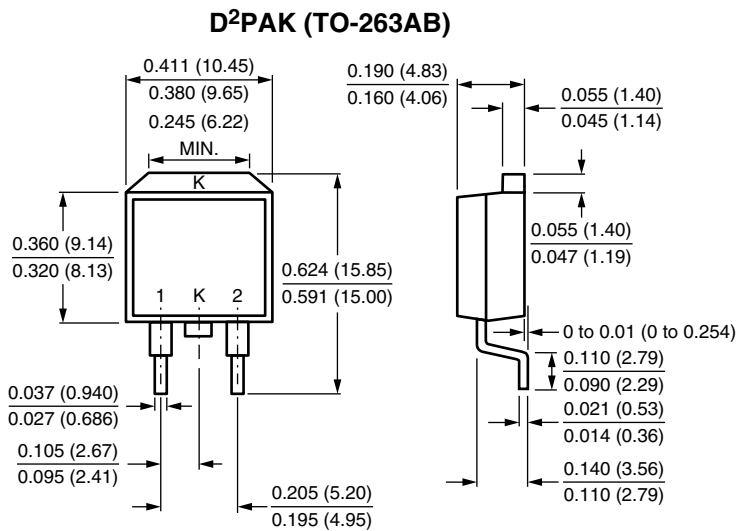
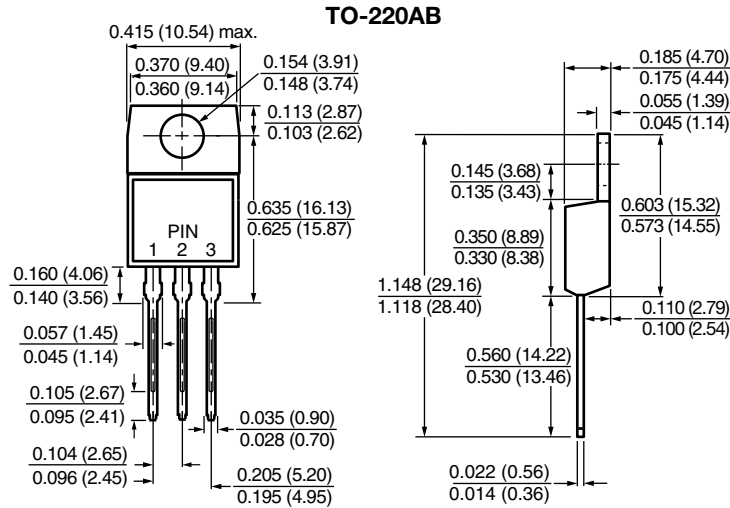

Fig. 6 - Typical Transient Thermal Impedance Per Diode



### PACKAGE OUTLINE DIMENSIONS in inches (millimeters)





## Disclaimer

ALL PRODUCT, PRODUCT SPECIFICATIONS AND DATA ARE SUBJECT TO CHANGE WITHOUT NOTICE TO IMPROVE RELIABILITY, FUNCTION OR DESIGN OR OTHERWISE.

Vishay Intertechnology, Inc., its affiliates, agents, and employees, and all persons acting on its or their behalf (collectively, "Vishay"), disclaim any and all liability for any errors, inaccuracies or incompleteness contained in any datasheet or in any other disclosure relating to any product.

Vishay makes no warranty, representation or guarantee regarding the suitability of the products for any particular purpose or the continuing production of any product. To the maximum extent permitted by applicable law, Vishay disclaims (i) any and all liability arising out of the application or use of any product, (ii) any and all liability, including without limitation special, consequential or incidental damages, and (iii) any and all implied warranties, including warranties of fitness for particular purpose, non-infringement and merchantability.

Statements regarding the suitability of products for certain types of applications are based on Vishay's knowledge of typical requirements that are often placed on Vishay products in generic applications. Such statements are not binding statements about the suitability of products for a particular application. It is the customer's responsibility to validate that a particular product with the properties described in the product specification is suitable for use in a particular application. Parameters provided in datasheets and / or specifications may vary in different applications and performance may vary over time. All operating parameters, including typical parameters, must be validated for each customer application by the customer's technical experts. Product specifications do not expand or otherwise modify Vishay's terms and conditions of purchase, including but not limited to the warranty expressed therein.

Hyperlinks included in this datasheet may direct users to third-party websites. These links are provided as a convenience and for informational purposes only. Inclusion of these hyperlinks does not constitute an endorsement or an approval by Vishay of any of the products, services or opinions of the corporation, organization or individual associated with the third-party website. Vishay disclaims any and all liability and bears no responsibility for the accuracy, legality or content of the third-party website or for that of subsequent links.

Except as expressly indicated in writing, Vishay products are not designed for use in medical, life-saving, or life-sustaining applications or for any other application in which the failure of the Vishay product could result in personal injury or death. Customers using or selling Vishay products not expressly indicated for use in such applications do so at their own risk. Please contact authorized Vishay personnel to obtain written terms and conditions regarding products designed for such applications.

No license, express or implied, by estoppel or otherwise, to any intellectual property rights is granted by this document or by any conduct of Vishay. Product names and markings noted herein may be trademarks of their respective owners.