

BG-612

(6V 1.2Ah/20hr)

Rechargeable Sealed Lead Acid Battery



These rechargeable batteries are lead-lead dioxide systems. The dilute sulfuric acid electrolyte is absorbed by separators and thus immobilized. Should the battery be accidentally overcharged producing hydrogen and oxygen, special one-way valves allow the gases to escape thus avoiding excessive pressure build-up. Otherwise, the battery is completely sealed and is, therefore, maintenance-free, leak proof and usable in any position.

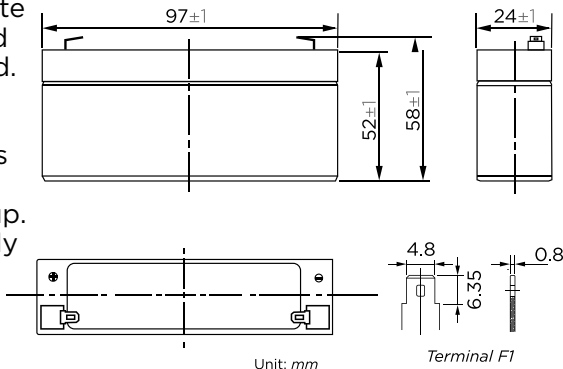

Performance Characteristics

Capacity 77°F(25°C)	20 hour rate (0.06A, 5.25V)	1.2Ah
	10 hour rate (0.11A, 5.25V)	1.1Ah
	5 hour rate (0.21A, 5.25V)	1.05Ah
	1 hour rate (0.78A, 4.8V)	0.78Ah
Internal Resistance	Full charged Battery 77°F(25°C): 50mΩ	
Capacity affected by Temperature (20 hour rate)	104°F(40°C)	102%
	77°F(25°C)	100%
	32°F(10°C)	85%
	5°F(-15°C)	65%
Self-Discharge 68°F(20°C)	Capacity after 3 month storage	90%
	Capacity after 6 month storage	80%
	Capacity after 12month storage	60%
Max. discharge current 77°F(25°C): 18A(5S)		
Charge (Constant Voltage)	Float: 6.8-6.9 V/77°F(25°C)	
	Cycle: 7.25-7.45 V/77°F(25°C) Max. Current: 0.3A	

SPECIFICATION

Nominal voltage	_____	6V
Number of cells	_____	3
Length (mm/inch)	_____	97/3.82
Width (mm/inch)	_____	24/0.97
Height (mm/inch)	_____	52/2.05
Total Height (mm/inch)	_____	58/2.28
Approx. Weight (kg/lbs)	_____	0.3/0.66

General Features

- Absorbent Glass Mat (AGM) technology for efficient gas recombination of up to 99% and freedom from electrolyte maintenance or water adding.
- Not restricted for air transport-complies with IATA/ICAO Special Provision A67.
- UL-recognized component.
- Can be mounted in any orientation.
- Computer designed lead, calcium tin alloy grid for high power density.
- Long service life, float or cyclic applications.
- Maintenance-free operation.
- Low self discharge.

Discharge Constant Current (Amperes at 77°F 25°C)

End Points Volts/Cell	5 min	10 min	15 min	30 min	1h	3h	5h	10h	20h
1.60V	5.00	3.50	2.50	1.48	0.78	0.35	0.22	0.11	0.06
1.65V	4.71	3.35	2.37	1.41	0.75	0.34	0.22	0.11	0.06
1.70V	4.36	3.20	2.24	1.32	0.72	0.32	0.21	0.11	0.06
1.75V	4.00	3.00	2.10	1.22	0.68	0.30	0.21	0.11	0.06
1.80V	3.60	2.70	1.95	1.09	0.63	0.28	0.20	0.10	0.05

Discharge Constant Power (Watts at 77°F 25°C)

End Points Volts/Cell	5 min	10 min	15 min	30 min	45 min	1h	2h	3h	5h
1.60V	8.80	6.02	4.80	2.75	2.08	1.64	1.00	0.72	0.50
1.65V	7.38	5.73	4.58	2.63	1.99	1.58	0.96	0.69	0.50
1.70V	6.93	5.40	4.33	2.50	1.87	1.47	0.90	0.65	0.48
1.75V	6.44	5.02	4.02	2.34	1.71	1.37	0.83	0.61	0.48
1.80V	5.84	4.56	3.61	2.13	1.52	1.21	0.73	0.54	0.48

Battery Construction

Component	Positive plate	Negative plate	Container	Cover	Safety valve	Terminal	Separator	Electrolyte
Raw material	Lead dioxide	Lead	ABS	ABS	Rubber	Copper	Fiberglass	Sulfuric acid



Charge characteristic curve

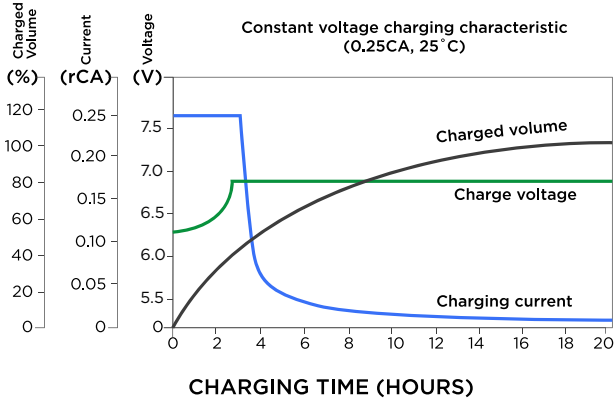

Discharge characteristic (25°C)

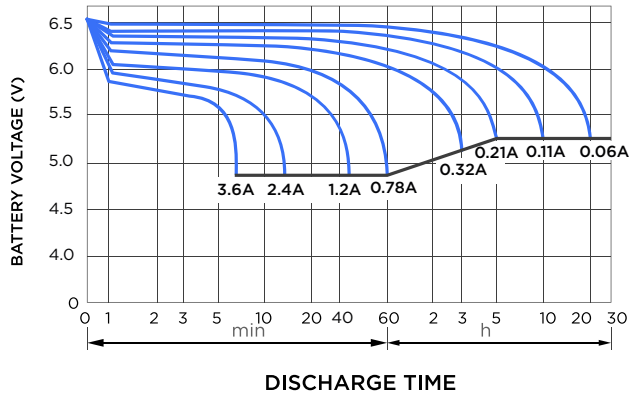

Temperature effects on float life

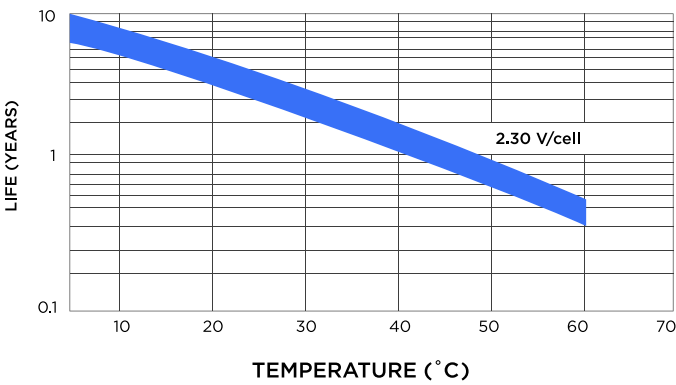

Cycle service life in relation to depth of discharge

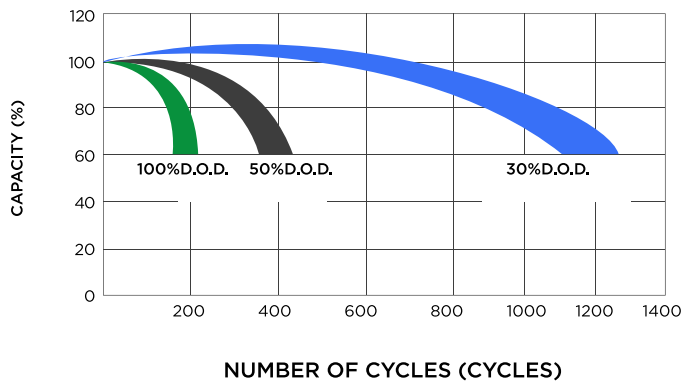

Relationship between charging voltage and temperature

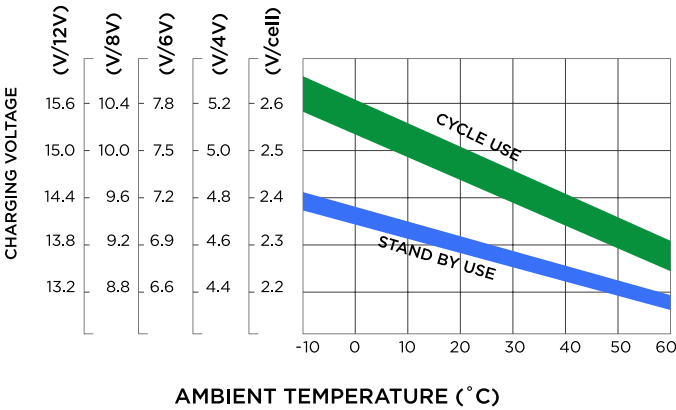

Self-discharge characteristic

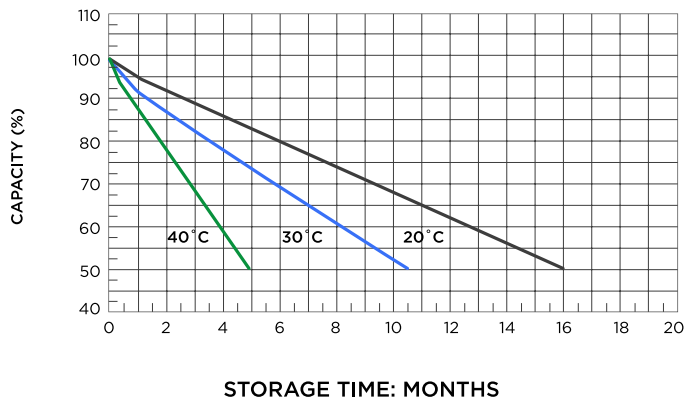

Life characteristics of standby use

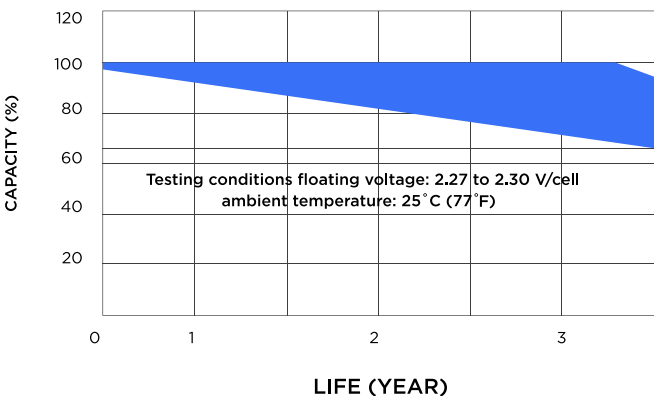

Temperature effects on capacity

