

DESIGNED AND DIMENSIONED IN MILLIMETERS [INCHES]
 ALL DIMENSIONS REFERENCE EXCEPT AS SHOWN

DO NOT SCALE FROM THIS PRINT

Pb THIS PRODUCT MANUFACTURED WITH LEAD-FREE PROCESSING

BE70A-X-XXXX-X-X-XX-XXXX

TRANSMISSION TYPE
 -S: STRIPLINE
 -M: MICROSTRIP

END 2 CONNECTOR
 (SEE TABLE 2, SHT 3)

PHASE MATCHING SPEC (RANGE)
 -2: 2 PICO-SECONDS
 -5: 5 PICO-SECONDS
 -N: NO PHASE MATCHING

OVERALL ASSEMBLY LENGTH (OAL)
 XXXX (MILLIMETERS)
 (0152 MIN)
 (SEE NOTE 6)

NO OF POSITION (PER ROW)
 -03, -04, -06, -08, -10, -12, -14, -16
 (SEE TABLE 4, SHT 3)

NO OF ROWS
 -2

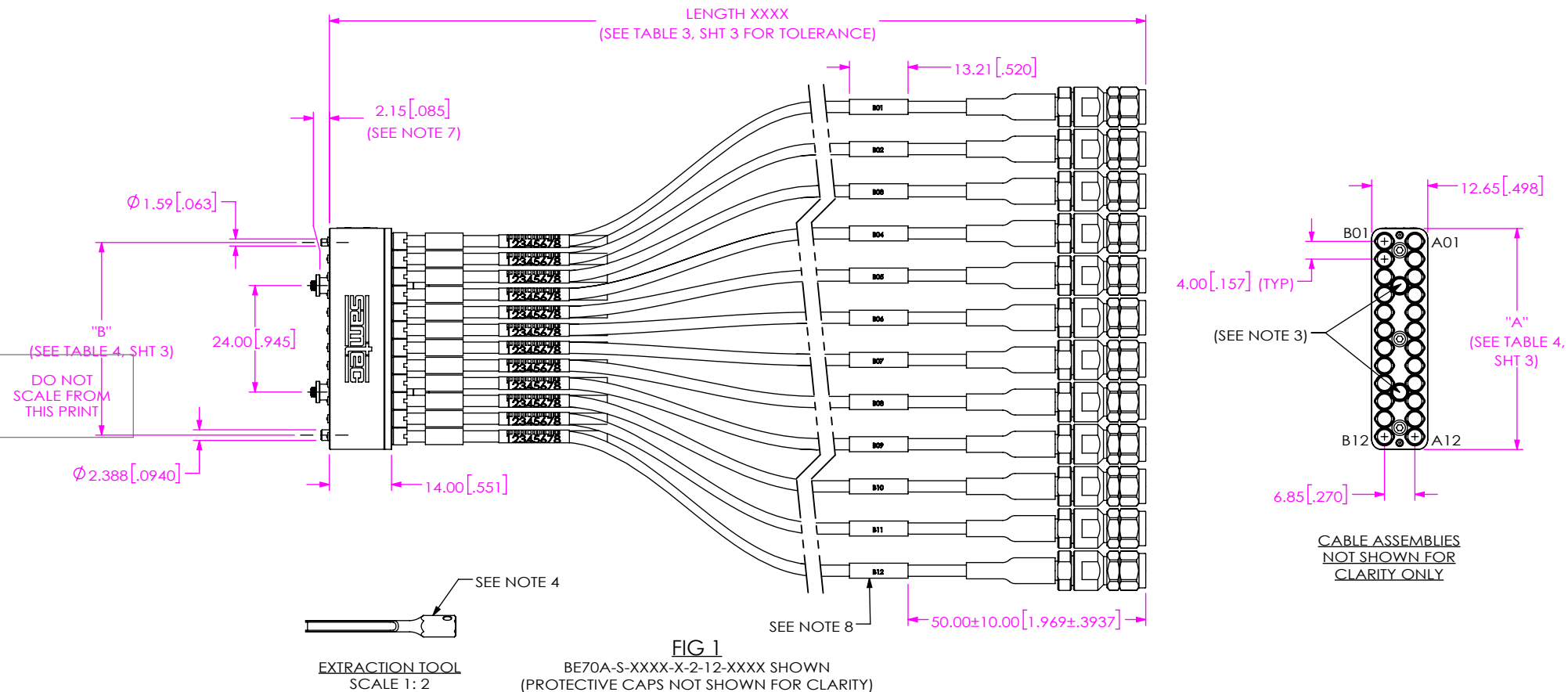

FIG 1
 BE70A-S-XXXX-X-2-12-XXXX SHOWN
 (PROTECTIVE CAPS NOT SHOWN FOR CLARITY)

NOTES:

1. FERRULE AND SPRING ARE FREE FLOATING AND ARE NOT STATIONARY.
2. ASSEMBLY TO HAVE END 1 WRAPPED IN ANTI-STATIC BUBBLE WRAP
 END 2 ASSEMBLED WITH PROTECTIVE CAPS.
3. WHEN MOUNTED TO PCB, TIGHTEN PCB SCREW TO 2.0 - 2.5 IN-LBS USING
 0.125" HEX TOOL (NOT PROVIDED).
4. EXTRACTION TOOL TO BE PACKAGED IN ESD BAG (BG-04-06-Z) AND INCLUDED WITH ASSEMBLY.
5. NOTE DELETED.
6. CABLE LENGTHS LONGER THAN 1000 MILLIMETERS ARE NOT SUPPORTED S.I. TEST DATA.
7. RECOMMEND PCB THICKNESS: 0.06IN - 0.16IN.
8. PRINT CABLE POSITION ON WHITE HEAT SHRINK AND APPLY TO CABLES AS SHOWN.
9. REF P/N: RSP-211900-X-X-XX-XXXX.

<p>PROPRIETARY NOTE</p> <p>THIS DOCUMENT CONTAINS CONFIDENTIAL AND PROPRIETARY INFORMATION AND ALL DESIGN, MANUFACTURING, REPRODUCTION, USE, PATENT RIGHTS AND SALES RIGHTS ARE EXPRESSLY RESERVED BY SAMTEC, INC. THIS DOCUMENT SHALL NOT BE DISCLOSED, IN WHOLE OR PART, TO ANY UNAUTHORIZED PERSON OR ENTITY NOR REPRODUCED, TRANSFERRED OR INCORPORATED IN ANY OTHER PROJECT IN ANY MANNER WITHOUT THE EXPRESS WRITTEN CONSENT OF SAMTEC, INC.</p>		<p>520 PARK EAST BLVD, NEW ALBANY, IN 47150 PHONE: 812-944-6733 FAX: 812-948-5047 e-Mail: info@SAMTEC.com code 55322</p>	
<p>MATERIAL: DO NOT SCALE DRAWING SHEET SCALE: 0.75:1</p> <p>HOUSING, COVER, SCREWS, NUTS, SHELL, RETAINER, FERRULE, PIN, BODY: BRASS ALIGNMENT PINS, SCREWS, SHELLS, CABLE BODY, C-RING, NUT INSERT: STAINLESS STEEL</p>		<p>DESCRIPTION: BE70A GANGED ASSEMBLY</p> <p>DWG. NO. BE70A-X-XXXX-X-X-XX-XXXX</p>	
<p>F:\DWG\MISC\MKTG\BE70A-X-XXXX-X-X-XX-XXXX-MKT.SLDDRW</p>		<p>BY: SHERRY W 12/26/2019 SHEET 1 OF 4</p>	

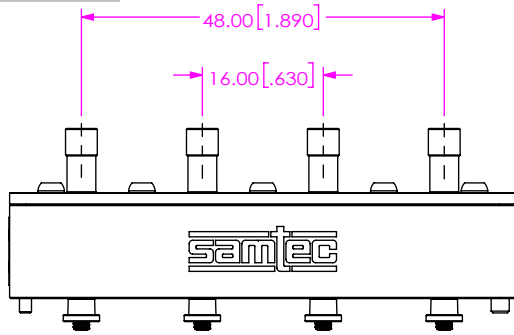

FIG 2
BE70A-S-XXXX-X-2-16-XXXX SHOWN
CABLE ASSEMBLIES NOT SHOWN FOR CLARITY

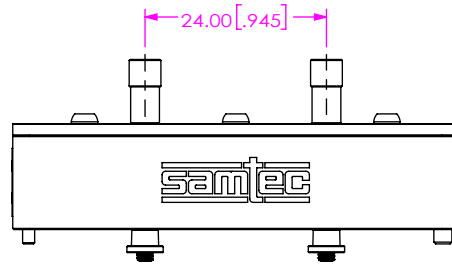

FIG 3
BE70A-S-XXXX-X-2-14-XXXX SHOWN
CABLE ASSEMBLIES NOT SHOWN FOR CLARITY

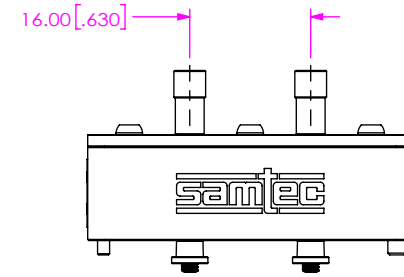

FIG 4
BE70A-S-XXXX-X-2-10-XXXX SHOWN
CABLE ASSEMBLIES NOT SHOWN FOR CLARITY

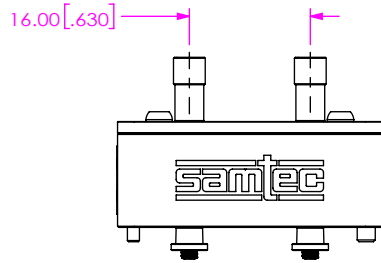

FIG 5
BE70A-S-XXXX-X-2-08-XXXX SHOWN
CABLE ASSEMBLIES NOT SHOWN FOR CLARITY

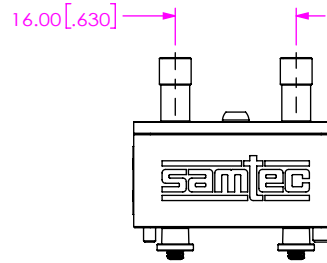

FIG 6
BE70A-S-XXXX-X-2-06-XXXX SHOWN
CABLE ASSEMBLIES NOT SHOWN FOR CLARITY

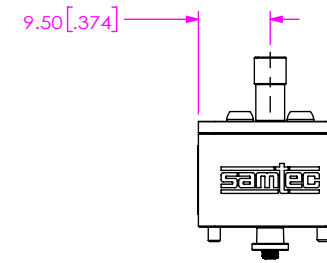

FIG 7
BE70A-S-XXXX-X-2-04-XXXX SHOWN
CABLE ASSEMBLIES NOT SHOWN FOR CLARITY

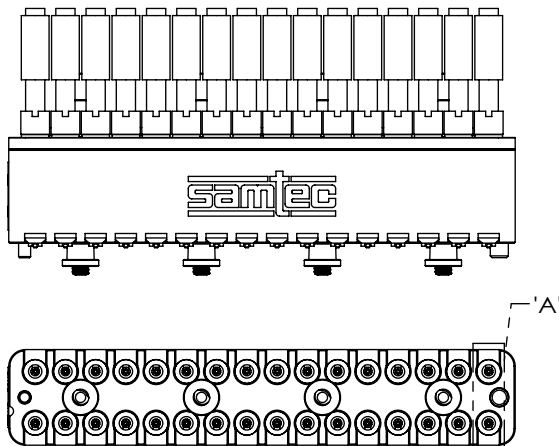
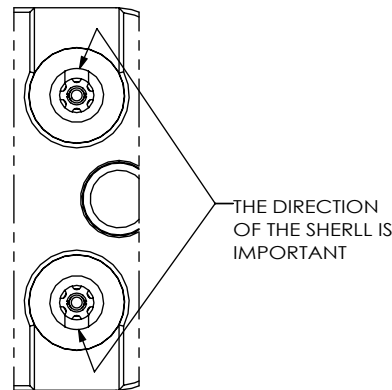

FIG 9
BE70A-M-XXXX-X-2-16-XXXX SHOWN
(DIFFERENT AS SHOWN, OTHERWISE SAME AS FIG 2)
END 2 NOT SHOWN FOR CLARITY



DETAIL 'A'
SCALE 4:1

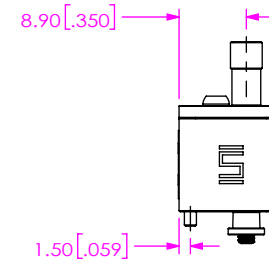

FIG 8
BE70A-S-XXXX-X-2-03-XXXX SHOWN
CABLE ASSEMBLIES NOT SHOWN FOR CLARITY

PROPRIETARY NOTE
THIS DOCUMENT CONTAINS CONFIDENTIAL AND PROPRIETARY INFORMATION AND ALL DESIGN, MANUFACTURING, REPRODUCTION, USE, PATENT RIGHTS AND SALES RIGHTS ARE EXPRESSLY RESERVED BY SAMTEC, INC. THIS DOCUMENT SHALL NOT BE DISCLOSED, IN WHOLE OR PART, TO ANY UNAUTHORIZED PERSON OR ENTITY NOR REPRODUCED, TRANSFERRED OR INCORPORATED IN ANY OTHER PROJECT IN ANY MANNER WITHOUT THE EXPRESS WRITTEN CONSENT OF SAMTEC, INC.

DO NOT SCALE DRAWING

SHEET SCALE: 1:1



520 PARK EAST BLVD, NEW ALBANY, IN 47150
PHONE: 812-944-6733 FAX: 812-948-5047
e-Mail: info@SAMTEC.com code 55322

DESCRIPTION:
BE70A GANGED ASSEMBLY

DWG. NO.
BE70A-X-XXXX-X-X-XX-XXXX

BY: SHERRY W 12/26/2019 SHEET 2 OF 4

TABLE 2							
END OPTION	SERIES	GENDER	FINISH			CONNECTOR KIT P/N (PCI P/N)	FIGURE
			CENTER CONTACT	OUTER CONTACT	CABLE BODY		
-18SP	1.85 MM	PLUG	50µ" GOLD	PASSIVATED	PASSIVATED	PRF18-P-C-EP-086-SS (4192)	SHT 4, FIG 10
-18SJ	1.85 MM	JACK	50µ" GOLD	PASSIVATED	PASSIVATED	PRF18-J-C-EP-086-SS (4183)	SHT 4, FIG 11

TABLE 5 - PHASE MATCHED PAIRS		
PAIR NO.	POSITION	POSITION
1	A01	B01
2	A02	B02
3	A03	B03
4	A04	B04
5	A05	B05
6	A06	B06
7	A07	B07
8	A08	B08
9	A09	B09
10	A10	B10
11	A11	B11
12	A12	B12
13	A13	B13
14	A14	B14
15	A15	B15
16	A16	B16

CAUTION: EACH PAIR OF CABLES TO BE PHASE MATCHED PER CALLOUT. IF RE-WORKED, THE ENTIRE PAIR MUST BE REPLACED.

TABLE 3: FINAL ASSEMBLY LENGTH TOLERANCE	
OVERALL LENGTH	TOLERANCE
0152-0200 [5.98-7.87]	+3.0 [.12] / -0.0 [.00]
0201-0500 [7.91-19.69]	+5.0 [.20] / -0.0 [.00]
0501-9999 [19.72-393.66]	+10.0 [.39] / -0.0 [.00]

TABLE 4		
No OF POSITIONS	"A"	"B"
-03	13.80 [0.543]	N/A
-04	19.00 [0.748]	14.80 [0.583]
-06	27.00 [1.063]	22.80 [0.898]
-08	35.00 [1.378]	30.80 [1.213]
-10	43.00 [1.693]	38.80 [1.528]
-12	49.80 [1.961]	43.40 [1.709]
-14	59.00 [2.323]	54.80 [2.157]
-16	67.00 [2.638]	62.80 [2.472]

<p>PROPRIETARY NOTE</p> <p>THIS DOCUMENT CONTAINS CONFIDENTIAL AND PROPRIETARY INFORMATION AND ALL DESIGN, MANUFACTURING, REPRODUCTION, USE, PATENT RIGHTS AND SALES RIGHTS ARE EXPRESSLY RESERVED BY SAMTEC, INC. THIS DOCUMENT SHALL NOT BE DISCLOSED, IN WHOLE OR PART, TO ANY UNAUTHORIZED PERSON OR ENTITY NOR REPRODUCED, TRANSFERRED OR INCORPORATED IN ANY OTHER PROJECT IN ANY MANNER WITHOUT THE EXPRESS WRITTEN CONSENT OF SAMTEC, INC.</p>	 <p>520 PARK EAST BLVD, NEW ALBANY, IN 47150 PHONE: 812-944-6733 FAX: 812-948-5047 e-Mail info@SAMTEC.com code 55322</p>
MATERIAL: DO NOT SCALE DRAWING	DESCRIPTION: BE70A GANGED ASSEMBLY
SHEET SCALE: 1:1	DWG. NO. BE70A-X-XXXX-X-X-XX-XXXX
F:\DWG\MISC\MKTG\BE70A-X-XXXX-X-X-XX-XXXX-MKT.SLDDRW	BY: SHERRY W 12/26/2019 SHEET 3 OF 4

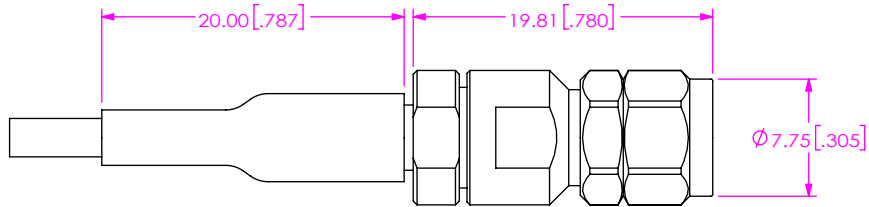

FIG 10
-18SP SHOWN
(CABLE CUT FOR CLARITY ONLY)

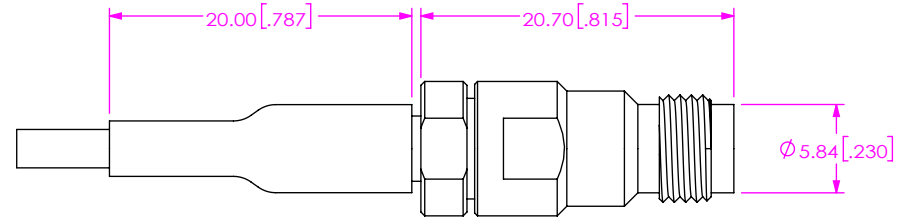
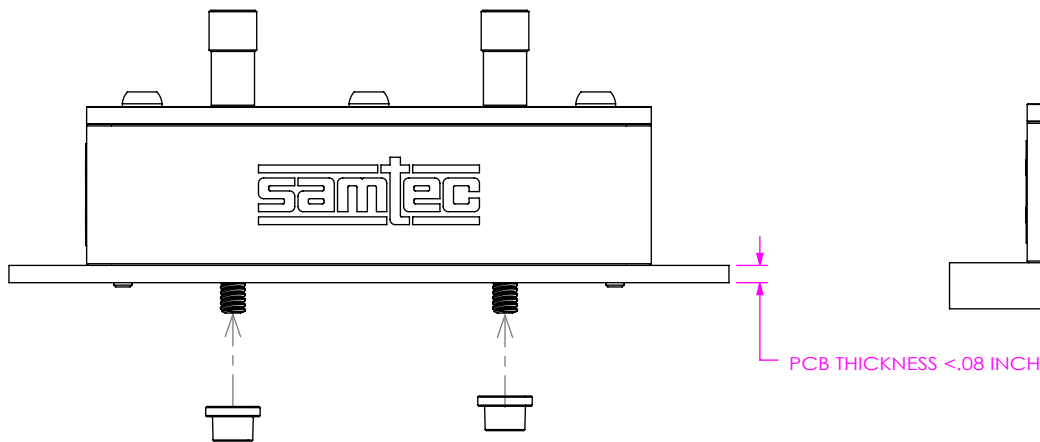
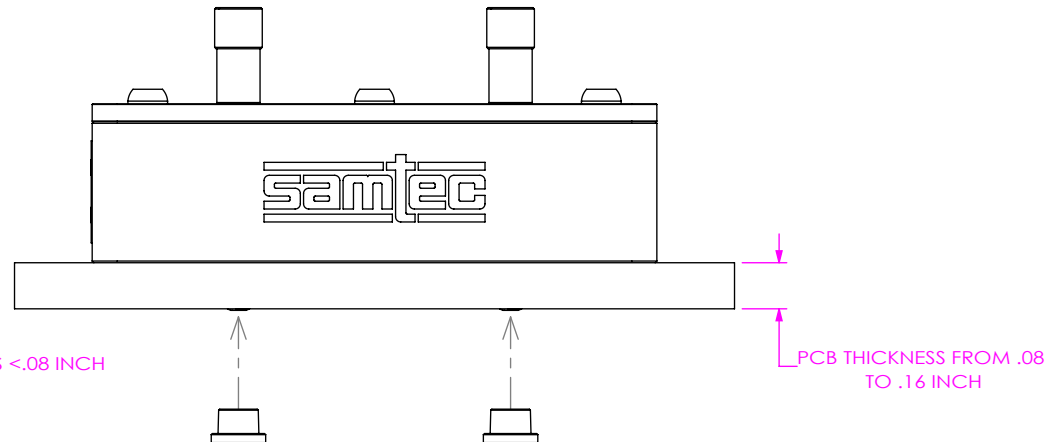

FIG 11
-18SJ SHOWN
(CABLE CUT FOR CLARITY ONLY)



SCALE: 1.5 : 1



SCALE: 1.5 : 1

DIRECTION OF PCB NUTS

PROPRIETARY NOTE
THIS DOCUMENT CONTAINS CONFIDENTIAL AND PROPRIETARY INFORMATION AND ALL DESIGN, MANUFACTURING, REPRODUCTION, USE, PATENT RIGHTS AND SALES RIGHTS ARE EXPRESSLY RESERVED BY SAMTEC, INC. THIS DOCUMENT SHALL NOT BE DISCLOSED, IN WHOLE OR PART, TO ANY UNAUTHORIZED PERSON OR ENTITY NOR REPRODUCED, TRANSFERRED OR INCORPORATED IN ANY OTHER PROJECT IN ANY MANNER WITHOUT THE EXPRESS WRITTEN CONSENT OF SAMTEC, INC.

MATERIAL: DO NOT SCALE DRAWING

SHEET SCALE: 2:1



520 PARK EAST BLVD, NEW ALBANY, IN 47150
PHONE: 812-944-6733 FAX: 812-948-5047
e-Mail: info@SAMTEC.com code 55322

DESCRIPTION: BE70A GANGED ASSEMBLY

DWG. NO. BE70A-X-XXXX-X-X-XX-XXXX

BY: SHERRY W 12/26/2019 SHEET 4 OF 4