

# ATP19 Series Anti-Vandal Sealed Pushbutton Switch

## Features/Benefits

- Momentary or Lock version
- IP67 sealed & IK10 (Stainless steel bushing)
- Capable of up to 3A resistive load
- 50,000 life cycle at full load
- Various colors of LED illuminate indicator
- Choices of pushbutton with symbol on spot, ring or power logo

## Typical Applications

- Control Panels including car park and traffic light
- Industrial Instruments
- Lifts / Escalator
- Communication equipment
- Alarm, safety and security systems



## Specifications

FUNCTION: Single pole and double poles  
CONTACT ARRANGEMENT: N.O. and N.C.  
MOUNTING TYPE: Threaded front panel mount  
TORQUE FOR THREADED BODY: 5-14 Nm

## Mechanical

OPERATING LIFE: Momentary 1,000,000 cycles  
Self-lock 500,000 cycles  
TOTAL TRAVEL: about 3.2 mm  
OPERATING FORCE: 1 pole 2.5 ± 1N  
2 pole 3.5 ± 1N

## Electrical

CONTACT RATING: 1th 5A/250VAC  
3A / 250VAC  
3A / 28VDC  
OPERATING LIFE: 50,000 make-and-break cycles at full load  
DIELECTRIC STRENGTH: 2,000 V RMS @ sea level  
INSULATION RESISTANCE: 1,000 MΩ min. @ 500 VDC  
INITIAL CONTACT RESISTANCE : 50 mΩ max @1A 12VDC

## Materials

BUSHING: Stainless steel / Nickel plated brass / Aluminum alloy  
BASE: PBT (UL 94-A0), PC (UL 94-V2)  
ACTUATOR: PC (UL 94-V2); Stainless steel / Nickel plated brass / Aluminum alloy  
INTERNAL ASSEMBLY: POM / PA66  
SPRING: Steel  
SEALING / O-ring: Silicone  
TERMINALS: Brass with silver or gold plated  
CONTACT: Copper, silver plated

## Operating Environment

OPERATING TEMPERATURE: -20°C to +55°C  
SEALING / PROTECTION: IP67 / IK10 (Stainless steel bushing)

**NOTE:** Specifications and materials listed above are for switches with standard options.  
For information on specific and custom switches, please contact Customer Service.

## Build-A-Switch

To order, simply select desired option from each category and place in the appropriate box.



**Designation**  
ATP19 Series

- Actuator Style**
- S** Standard
  - R** Raised #
  - D** Dome without LED only ###

- Actuator Indicator**
- L0** Without LED \*
  - L1** Fix ring \*
  - L2** Spot \*
  - L3** Moving ring \* (standard actuator only)
  - L4** Power logo \*\*
  - L5** Moving ring & Power logo \*\* (standard actuator only)

### LED Illumination

Color	Dual color
<b>0</b> Without LED	<b>A</b> Red & Green
<b>2</b> White	<b>B</b> Red & Blue
<b>3</b> Red	<b>D</b> Blue & Yellow
<b>5</b> Yellow	<b>G</b> Red & Yellow
<b>6</b> Green	<b>H</b> Green & Yellow
<b>7</b> Blue	<b>J</b> Orange & Green

### LED voltage (20mA)

- 00** Without LED
- 03** 3V
- 06** 6V
- 12** 12V
- 24** 24V
- 36** 36V
- A1** 110V AC
- A2** 220V AC

- Terminal plating**
- Q** Silver
  - G** Gold

- Termination**
- 03** STD solder lug
  - 04** Short solder lug
  - W1** Wire lead 500mm \*\*\*
  - W2** Wire lead 1,000mm \*\*\*

- Mechanical function**
- A** Momentary
  - E** Lock

- Contact arrangement**
- S** SPDT
  - D** DPDT

### Bushing type

Round	Double D shape
<b>B0</b> Stainless (Natural)	<b>M0</b> Stainless (Natural)
<b>B3</b> Al alloy (Black anodized) ##	<b>M3</b> Al alloy (Black anodized) ##

- \* Available on round bushing only
- \*\* Available on double D-shape bushing only
- \*\*\* Available upon request, please contact your sales representative for details
- # Come in B0 & M0 with L1 or L4 indicator only
- ## Come in S style actuator only & no L5 indicator
- ### Without LED & for B0 & M0 bushing type only

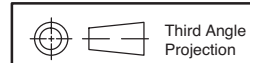

Dimensions are shown: mm (inches)  
Specifications and dimensions subject to change





# ATP19 Series Anti-Vandal Sealed Pushbutton Switch

Pushbutton  
A

## STANDARD VIEW

**ROUND BUSHING**

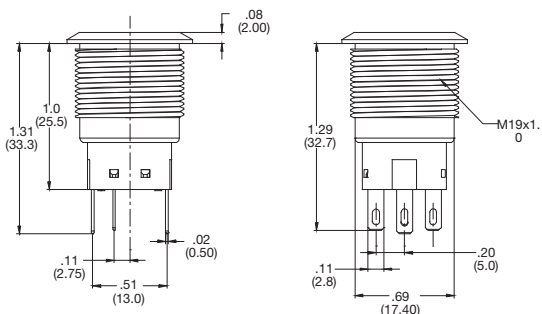

**DOUBLE-D BUSHING**

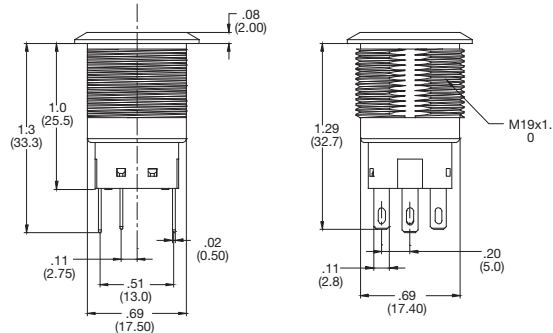

## ACTUATOR STYLE

**S STANDARD**

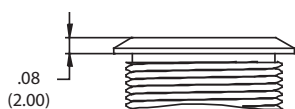

**R RAISED**

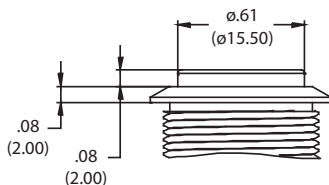

**D DOME**

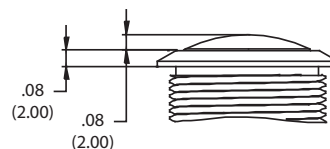

## ACTUATOR INDICATOR

**L0 WITHOUT LED**

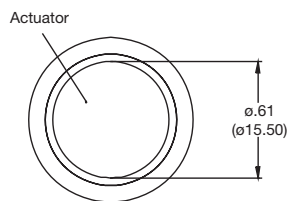

**L1 FIX RING**

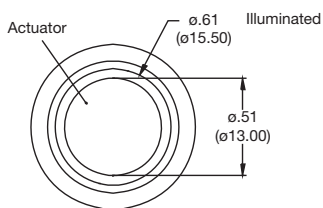

**L3 MOVING RING**

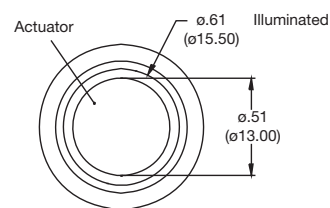

**L2 SPOT**

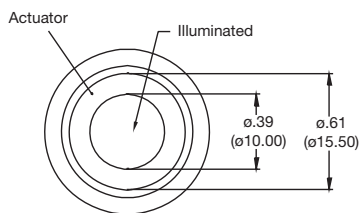

**L4 POWER LOGO**

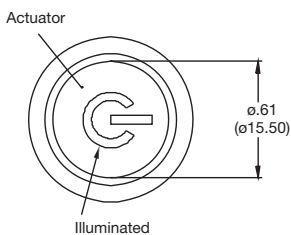

**L5 POWER & MOVING RING**

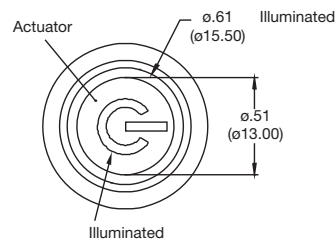

# ATP19 Series Anti-Vandal Sealed Pushbutton Switch



A  
Pushbutton

## CIRCUIT

SPDT

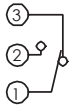

SPDT - SINGLE COLOR LED

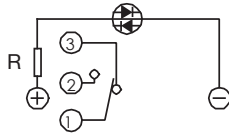

SPDT - DUAL COLOR LED

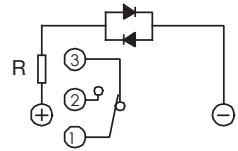

DPDT

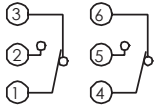

DPDT - SINGLE COLOR LED

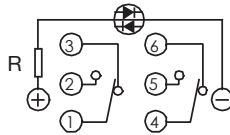

DPDT - DUAL COLOR LED

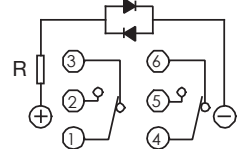

## TERMINATION

03 SOLDERLUG

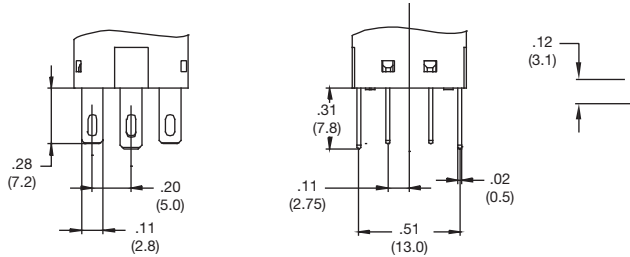

04 SHORT SOLDER LUG

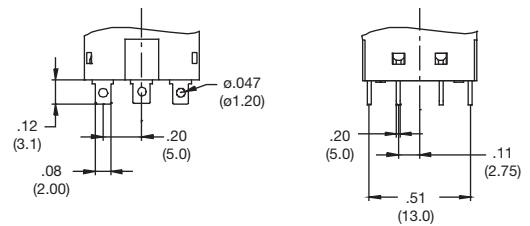

W1 OR W2 WIRE LEAD

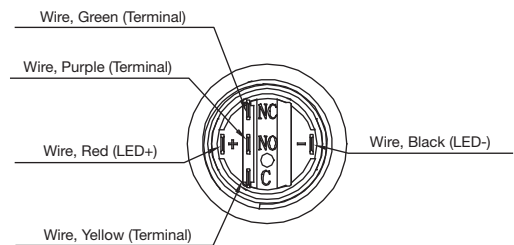
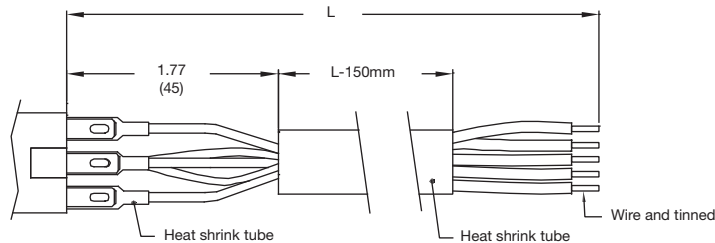

## HARDWARE

HEX NUT

Order PN: ATP19-HN

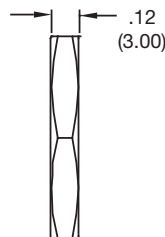
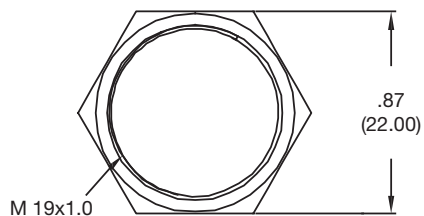

O RING

Order PN: ATP19-OR

