

REPLACEMENT AIR NOZZLES

Straight Single

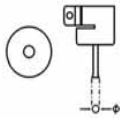

Nozzle Model	Nozzle Size, ϕ (mm)
1124	2.5
1130	4.4
1194	6
1195	6
1196	7
1197	9
1198	12

Bent Single

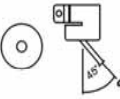

Nozzle Model	1142

Dual Single Adjustable

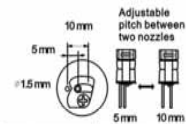

Nozzle Model	1325

Single In Line Package

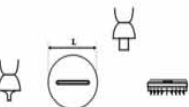

Nozzle Model	IC Package Size	Nozzle Length (mm)
1191	SIP 25L	26
1192	SIP 50L	52.5

Ball Grid Array

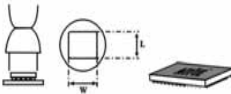

Nozzle Model	IC Package Size (mm)	Nozzle Size (mm)	
		W	L
1010	BGA 9x9	10	10
1313	BGA 12x12	13	13
1616	BGA 15x15	16	16
1919	BGA 18x18	19	19
2828	BGA 27x27	28	28
3636	BGA 35x35	36	36
3939	BGA 38x38	39	39
4141	BGA 40x40	41	41

Small Outline J-Lead



Nozzle Model	IC Package Size (mm)	Nozzle Size (mm)	
		L	W
1183	SOJ 15x8	16	8
1184	SOJ 18x8	19	10
1214	SOJ 10x26	25.9	12

Plastic Leaded Chip Carrier

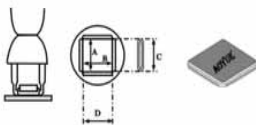

Nozzle Model	IC Package Size (mm)	Nozzle Size (mm)			
		A	B	C	D
1135	PLCC 17.5x17.5 (44pins)	18.5	18.5	15	15
1136	PLCC 20x20 (52pins)	21	21	19	19
1137	PLCC 25x25 (68pins)	26	26	24	24
1138	PLCC 30x30 (84pins)	31	31	29	29
1139	PLCC 7.3x12.5 (18pins)	9	14	69	69
1140	PLCC 11.5x11.5 (28pins)	13	13	15	10
1141	PLCC 11.5x14 (32pins)	15	13	15	10
1188	PLCC 9x9 (20pins)	11	11	10	10
1189	PLCC 34x34 (100pins)	36.5	36.5	33.5	33.5

Small-Outline Package

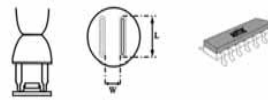

Nozzle Model	IC Package Size (mm)	Nozzle Size (mm)	
		L	W
1131	SOP 4.4x10	10	4.8
1132	SOP 5.6x13	15	5.7
1133	SOP 7.5x15	16	7.2
1134	SOP 7.5x18	19	7.2
1257	SOP 11x21	21	11.7
1258	SOP 7.6x12.7	11.7	8.2
1259	SOP 1.3x28	29	13.5
1260	SOP 8.6x18	19	8.7

Thin Small-Outline

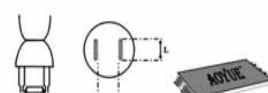

Nozzle Model	IC Package Size (mm)	Nozzle Size (mm)	
		L	W
1185	TSOL 13x10	10	11.9
1187	TSOL 18.5x8	10	18.5
1186	TSOL 18x10	11.7	18.2

Quad Flat Pack

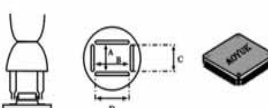

Nozzle Model	IC Package Size (mm)	Nozzle Size (mm)			
		A	B	C	D
1125	QFP 10x10	10.2	10.2	10	10
1126	QFP 14x14	15.2	15.2	15	15
1127	QFP 17.5x17.5	19.2	19.2	19	19
1128	QFP 14x20	15.2	21	15	21
1229	QFP 28x28	29.5	29.7	29	29
1215	QFP 42.5x42.5	42.5	42.5	40	40
1261	QFP 20x20	20.2	20.2	21	21
1262	QFP 12x12	12.2	12.2	12	12
1263	QFP 28x40	27.7	39.7	29	39
1264	QFP 40x40	40.2	40.2	39	39
1265	QFP 32x32	32.2	32.2	31	31

Bumpered Quad Flat Pack

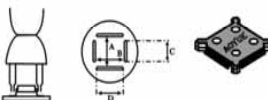

Nozzle Model	IC Package Size (mm)	Nozzle Size (mm)			
		A	B	C	D
1180	BQFP 17x17	18.2	18.2	13.6	13.6
1181	BQFP 19x19	19.2	19.2	16	16
1203	BQFP 35x35	35.2	35.2	30.6	30.6
1182	BQFP 24x24	24.2	24.2	21	21

AOYUE[®] INT 2702A+

Lead-Free Repairing System

INSTRUCTION MANUAL

Thank you for purchasing Aoyue Int2702A+ Repairing System. It is important to read the manual before using the equipment. Please keep manual in accessible place for future reference.



(*) Sold Separately

Manufacturer:
AOYUE TONGYI ELECTRONIC EQUIPMENT FACTORY
Jishui Industrial Zone, Nantou, Zhongshan City,
Guangdong Province, P.R.China
<http://www.aoyue.com>

This manual is designed to familiarize and instruct the operator with the proper usage and maintenance of the equipment. The "Care and Safety Precautions" section explains the hazards of using any type of soldering or reworking device. Please read carefully and observe the guidelines in order to maximize usage and minimize the risk of injury or accidents .

TABLE OF CONTENTS

Product Description	3
Specifications	3
Package Inclusion	4
Functions and Features	5
Safety Precautions	6
Assembly and Preparation	7
Control Panel Guide	8
Operating Guidelines	9—12
Auto-Sleep Functions	13—14
Digital Calibration	15—17
Care and Maintenance	18—20
Basic Troubleshooting Guide	21—22
Replacement Tips	23
Air Nozzles	24

REPLACEMENT TIPS

Bevel Type

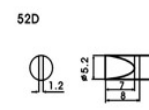
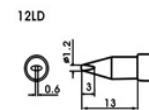
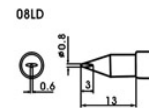
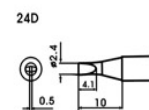
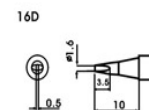
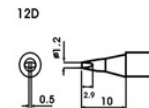
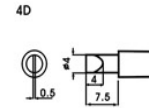
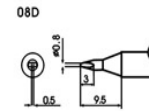

Chisel Type

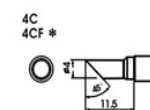
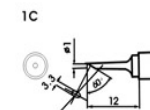
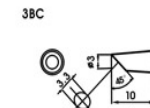
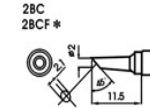
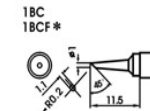

Flow Type

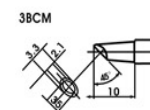
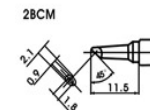

Conical Type

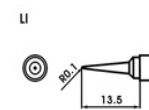
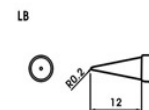
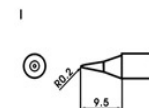
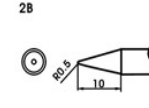
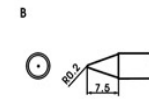

Tunnel Type

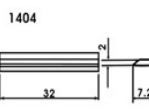
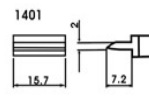

Blade Type

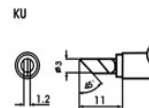
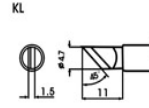
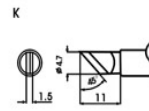

Sharp-Bent Type

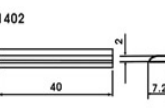
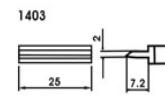
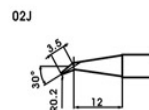

* These tips are flined on the soldering surface only.

(*) Sold Separately

BASIC TROUBLESHOOTING GUIDE

PROBLEM 7: AIR PRESSURE LEVEL IS SIGNIFICANTLY LOW NO MATTER HOW HIGH THE AIRFLOW LEVEL IS CALIBRATED

Case 1: Check the mains voltage (AC power source). If the voltage level falls significantly low, about 15-20% lower than the standard, there will also be a noticeable drop in the air pressure level.

SOLUTION:

Please refer to your local power service provider.

Case 2: The microcontroller might have detected the operating frequency incorrectly. The user will notice that airflow level is weaker with reference to the airflow gauge compared with the displayed value.

SOLUTION:

Turn off the unit and on again to let the device re-detect the proper operating frequency.

Case 3: The Suction Vacuum cap is connected to the Smoke Absorber Terminal or Vacuum cap instead of the Wire mesh cap.

SOLUTION:

Change the cap to the Wire mesh cap. This allows more air to pass through the system. Make sure as well that the vacuum tube of the soldering iron or desoldering gun is not connected.

Case 4: The Wire mesh cap is connected but airflow level is still low.

SOLUTION:

Check the filter pad inside for dirt that can block the air passage. Clean or replace if necessary.

ADDITIONAL SOLUTION: Check for any tangles in the tube of the hot air gun that can cause the air blockage.

PROBLEM 8: UNIT SHOWS UNCONVENTIONAL BEHAVIOR

Description: Unit operates erratically.

SOLUTION1: Try to switch OFF the device and switch ON again. Unplug the system from the main power source and plug in again when necessary

SOLUTION2: Restore unit to default factory setting. switch off/on the unit while holding the hot-air temperature down button until the banner finishes scrolling, the unit would revert to its default factory setting.

OTHER PROBLEMS NOT MENTIONED:

Contact the vendor.

PRODUCT DESCRIPTION

The Aoyue INT2702A+ Lead-Free Repairing System is a reworking equipment that combines the functionality of Hot Air Gun, Soldering Iron, Smoke Absorber, and Desoldering Gun in one package.

It has several safety features such as the auto-cooling process of the Hot Air Gun. This functionality protects the device (and its components) from excessive heat upon reaching any of the following conditions: (1) when the soldering gun remained idle on its resting handle after a certain period and (2) when the temperature of the device is above a safe threshold upon turning off. It has several advanced features such as solder iron digital calibration, configurable auto sleep for hot-air and soldering iron. Finally, the unique, innovative design with digital control panel and display provides precision, safety,

SPECIFICATION

MAIN STATION	
Power Input :	available in 110V / 220V
Station Dimensions:	188(w) x 126(h) x 250(d) mm
Weight:	5.6Kg
SOLDERING IRON	
Power Consumption:	70W
Temperature Range:	200°C - 480°C
Heating Element:	Ceramic Heater
Output Voltage:	24V
HOT AIR GUN	
Power Consumption:	500W
Temperature Range:	100°C - 480°C
Heating Element	Metal Heating Core
Pump/Motor Type:	Diaphragm Pump
Air Capacity:	23 l /min (max)
DESOLDERING GUN	
Temperature Range:	200°C - 480°C
Heating Element:	Ceramic Heater
Output Voltage:	24V

Specifications are subject to change without prior notice.

PACCKAGE INCLUSIONS

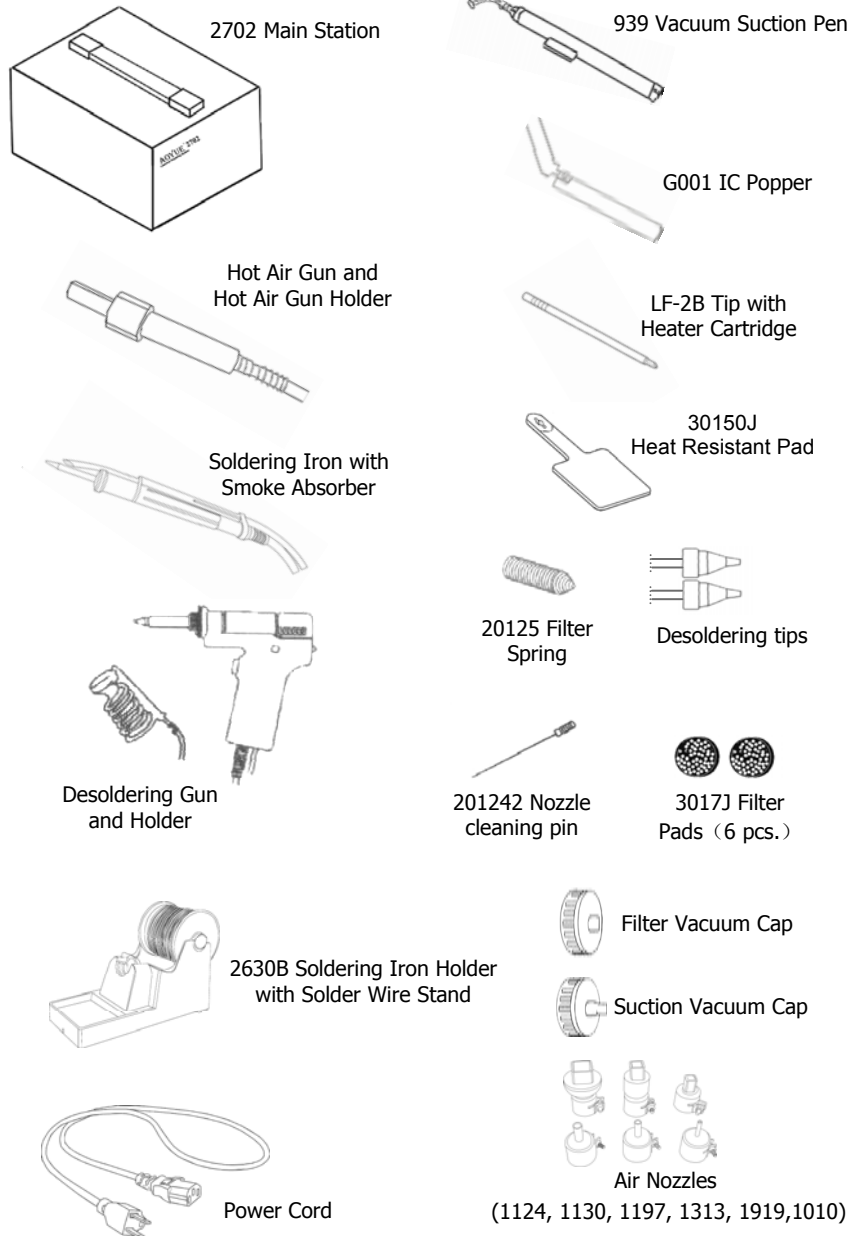

BASIC TROUBLESHOOTING GUIDE

PROBLEM 1: THE UNIT HAS NO POWER

1. Check if the unit is switched ON.
2. Check the fuse. Replace with the same type if fuse is blown.
3. Check the power cord and make sure there are no disconnections.
4. Verify that the unit is properly connected to the power source.

PROBLEM 2: HOT-AIR GUN TEMPERATURE DISPLAY IS ALWAYS ABOVE 500°C

Description: Constant display of above 500°C temperature from the panel then displays an "Err1" on the panel after a few minutes.

SOLUTION:

The thermal sensor may be broken and needs to be replaced.

PROBLEM 3: HOT-AIR GUN ACTUAL AIR TEMPERATURE IS NOT INCREASING

Description: Actual temperature reading is not increasing or decreasing based on desired level.

SOLUTION:

The heating element may be broken or is at the end of its life and needs to be replaced.

PROBLEM 4: THE UNIT IS VIBRATING TOO MUCH

SOLUTION: Check if the 4 screws that hold the pump in place are properly and tightly connected. Unplug the system from the main power source before opening the case to check inside the station.

PROBLEM 5: THE UNIT IS VERY NOISY

SOLUTION:

Make sure the screw at the center of the base of the main unit has been removed. This holds the pump in place during transportation and needs to be removed before using the equipment.

PROBLEM 6: SOLDERING IRON TEMPERATURE DISPLAY PANEL SHOWS "PLUG" CHARACTERS

Case 1: The system shows "PLUG" from the soldering iron temperature display panel .

SOLUTION 1: Check if the soldering iron connection assembly is properly connected and secured to the receptacle on the control panel.

SOLUTION 2: Make sure the soldering iron tip is properly inserted and secured inside the handle. Loose contacts between the tip and handle can also cause this error message.

SOLUTION 3: See "**Soldering Iron Error Messages**" on page 21 for further details.

CARE and MAINTENANCE

Changing nozzle:

- Unscrew the securing lock and pull out the heater external housing together with the securing lock, Nozzle can now be changed. Re-secure nozzle by tighten the securing lock on its receptacle.

Changing Filter pad and Filter Spring:

- Unlock the filter dock by toggling the filter dock locking mechanism. The filter dock would push out to allow easy extraction of the filter barrel assembly which houses the filter pad, filter spring and filter barrel cap.

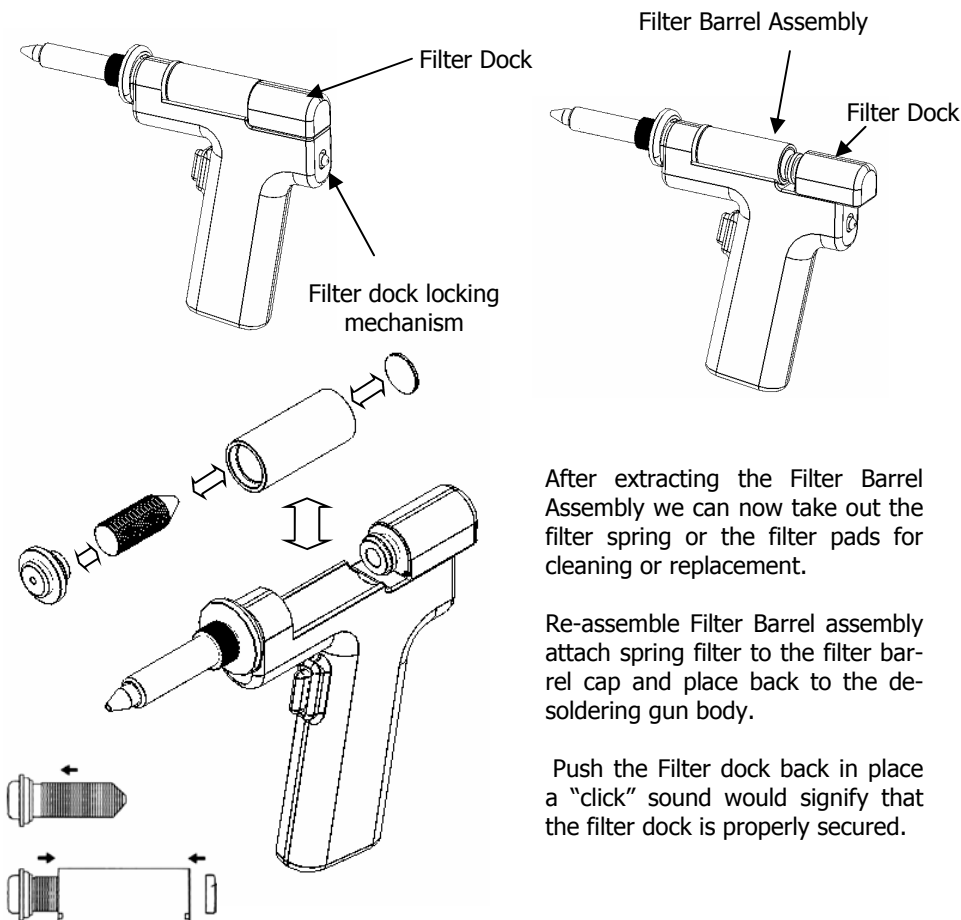

After extracting the Filter Barrel Assembly we can now take out the filter spring or the filter pads for cleaning or replacement.

Re-assemble Filter Barrel assembly attach spring filter to the filter barrel cap and place back to the desoldering gun body.

Push the Filter dock back in place a "click" sound would signify that the filter dock is properly secured.

FUNCTION and FEATURES

- Microprocessor-controlled ESD safe equipment.
- 3-in-1 repairing system combining Hot Air Gun, Soldering Iron, and Desoldering Gun in one sophisticated package.
- Digital control and display of hot air temperature, soldering iron temperature, desoldering gun temperature and air pressure with touch type panel controls for precision and ease of use.
- The desoldering gun is equipped with air cylinder type vacuum pump for stronger suction and zero-crossing circuit that prevents electrical surges.
- Integrated smoke absorber functionality with filter pad to efficiently absorb and filter harmful fumes.
- Uniquely designed compound tip that integrates the ceramic heating element and sensor in just one component. Replacing tips is as easy as slipping it in/out of the compatible 24V soldering iron.
- User configurable 1 to 30 minute idle-to-auto-stand-by mode (with 5 minutes as default) for additional device protection and power saving.
- Built-in auto-cooling process that protects the system and its components from excessive heat, prolonging usage life.
- Built-in auto-sleep mode for soldering iron and desoldering gun.
- Compatibility with air nozzles of various types.
- Compatibility with different kind of soldering tips.

SAFETY PRECAUTIONS

CAUTION: Improper usage can cause serious injury to personnel and/or damage to equipment. For your own safety, please observe the ff. precautions.

- Check each component after opening the package to make sure everything is in good condition. If there are any suspected damage, do not use the item and report the issue to your vendor.
- Turn OFF the main power switch and unplug the device when moving the device from one location to another.
- Do not strike or subject the main unit to physical shock. Use carefully to avoid injury and damage to any part.
- Handle with care.
 - Never drop or sharply jolt the unit.
 - Contains delicate parts that may break if the unit is dropped.
- Make sure the equipment is always grounded. Always connect power to a grounded receptacle.
- Temperature may reach as high as 480°C when switched ON.
 - Do not use the device near flammable gases, paper and other flammable materials.
 - Do not touch heated parts, which can cause severe burns.
 - Do not touch metallic parts near the tip.
- Disconnect the plug from the power source if the unit will not be used for a long period.
 - Turn off power during breaks, if possible.
- Use only genuine replacement parts.
 - Turn off power and let the unit cool before replacing parts.
- The unit may produce a small amount of smoke and unusual odor during initial usage. This is normal and should not yield any negative result when reworking.
- Soldering process produces smoke — use on well ventilated place.
- Do not alter the unit, specifically the internal circuitry, in any manner.

CARE and MAINTENANCE

4. Inside the pipe, the quartz glass and heat insulation are installed. Loosen the cable and take out the heating element.
5. Insert new heating element and reconnect the terminal. *Be careful not to rub Heating Element wire.*
6. Reconnect the ground wire after replacing the element.
7. Assemble the handle again.

Soldering Iron Error Messages

1. Soldering Iron connection assembly is not connected or not properly connected to the receptacle on the control panel.
2. Soldering iron tip is damaged and needs to be replaced. The device will display "PLUG".
3. Indicating a problem with the contacts of the soldering iron or the tip.



De-Soldering Gun

1. Before usage dampen the filter pads with a little bit of water to allow efficient air passage and filter action, re-dampen pads frequently for maximum efficiency.
2. Routinely clean Spring Filter, and replace filter pads when they are dirty or clogged .
3. The solder pathway can be cleaned using the provided Nozzle cleaning pin, use the cleaning pin when pathway seems clogged.

De-Soldering Gun Disassembled illustration:

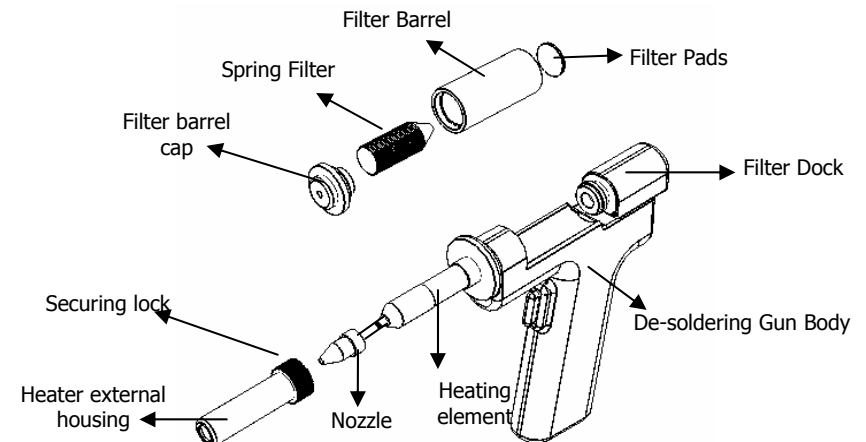

CARE and MAINTENANCE

Spare Parts Guide

Part No.	Description
10094	Hot air gun heating element
30106S	Plastic handle of hot air gun
S009	Hot air gun complete handle
20962	Hot air gun metal pipe
B012	Soldering Iron complete handle
C005	Desoldering gun heating element
3072D	Plastic handle of desoldering gun
B1003	Desoldering gun complete handle

Blower/Vacuum Air Terminal Filters

Filters should be cleaned and replaced regularly to avoid dirt which can clog the air passage. More importantly, this will also effectively clean the toxic fumes produced during soldering process.

Soldering Iron Tip

Always keep the solder-plated section of the tip/nozzle coated with a small amount of solder. Oxide coating on the tip of the nozzle reduces its heat conductivity. Coating the tip with a small amount of fresh solder ensures maximum heat conductivity is obtained.

Replacing the Soldering Iron tip

1. Always turn OFF main power switch when removing or inserting a tip.
2. If the tip is hot, use the heat resistant pad to pull it out.
3. Insert the new tip fully into the handle. If the tip is not fully inserted (or if the tip is damaged), the device will display "PLUG". Indicating a problem with the contacts of the soldering iron or the tip.

Replacing the heating element of the Hot Air Gun

The heating element is found in the middle part of the hot air gun. The normal life of a heating element is 1 year under normal operating conditions.

Steps:

1. Loosen the 3 screws that secure the handle.
2. Slide off the plastic tube.
3. Disconnect the ground wire sleeve.

ASSEMBLY and PREPARATIONS

A. Main Station

As soon as the equipment has been removed from the package, **REMOVE THE SCREW** located at the center of the bottom of the main unit. This screw holds the pump in place during transportation.

 **WARNING:** Failure to remove the screw before using the equipment can cause damage to the system.

B. Soldering Iron

1. Install the solder wire to the soldering iron holder as in Figure 1.

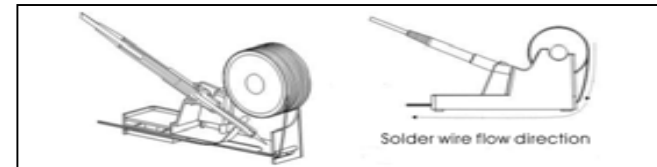

Figure 1. Soldering iron stand with solder wire holder

2. Connect the soldering iron cord assembly to the 6-pin output terminal found at the lower middle portion of the main unit.
3. Place the soldering iron to the soldering iron stand as shown above.

C. Smoke Absorber

1. Attach the smoke absorbing tube to the suction vacuum cap. Make sure the cord connections are free from tangles.

D. Hot Air Gun

The Hot Air Gun holder was installed on the station upside down for packaging purpose. To set up the Hot Air Gun holder:

1. Loosen the two screws that secure the holder to the station.
2. Turn the holder right side up.
3. Re-fasten the two screws.
4. Place the hot air gun onto the holder in preparation for usage.

E. Desoldering Gun

1. Connect the cord of the desoldering gun to the 6-pin terminal .
2. Connect the vacuum tube to the suction vacuum cap.
3. Place the desoldering gun onto the holder in preparation for usage.

CONTROL PANEL GUIDE

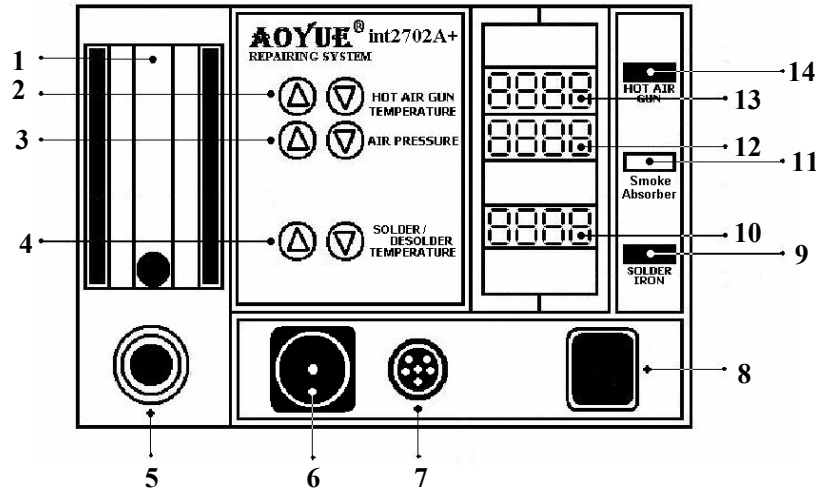

LEGEND:

- 1 — Airflow Gauge
- 2 — Hot Air Gun Temperature Adjustment Buttons
- 3 — Hot Air Gun Airflow Adjustment Buttons
- 4 — Soldering Iron / Desoldering Gun Temp Control Buttons
- 5 — Hot Air Gun Output Terminal
- 6 — Smoke Absorber Terminal or Vacuum Cap
- 7 — Soldering Iron / Desoldering Gun 6-Pin Receptacle
- 8 — Main Power Switch
- 9 — Soldering Iron / Desoldering Gun Activation Switch
- 10 — Soldering Iron / Desoldering Gun Temperature Display

Prefixes and meanings: "H" - actual temperature

"h" - temperature being set

- 12 — Hot Air Gun Air flow Display

- 13 — Hot Air Gun Temperature Display

Prefixes and meanings: "H" - actual temperature

"h" - temperature being set

"C" - cooling down

"---" - sleep mode display

"OFF" - function deactivated display

- 14 — Hot Air Gun Activation Switch

DIGITAL CALIBRATION

NOTES:

- The calibrated data is saved into the memory and shall remain effective until it is recalibrated again or new data is entered.
- If the maximum of 70 degrees has already been added or subtracted pressing the air pressure down button would not exit from calibration mode. Instead turning off the soldering iron function switch would exit from the calibration mode.
- If the maximum of 70 degrees has already been added, increasing further the temperature offset would not be allowed but subtracting temperature offset would be available. And consequently when the maximum of 70 degrees has already been subtracted, decreasing the temperature offset further would be disabled but increasing the temperature offset would be allowed.
- Calibration will only make the newly calibrated point the most accurate. Other temperature points may be a little off.
- The soldering Iron has a lowest temperature limit such that when the temperature has been set to 200 degrees with external actual temperature also showing 200 degrees, further decreasing the temperature offset would be only have minimal effect to the actual temperature.
- **To reset the calibration settings to factory setting**, switch off and on the unit and while holding the hot-air temperature up button until the banner finishes scrolling, the Set temperature / Temperature calibration of the unit would revert to its default factory setting.

DIGITAL CALIBRATION

- Adjust the temperature compensation using the **UP** and **DOWN** buttons of the Soldering iron adjustment buttons.
- A zero "0" on the first digit signifies addition to the current temperature and a minus "-" on the first digit will subtract the displayed value from the current settings.
- Confirm the change by pressing the air pressure down button.

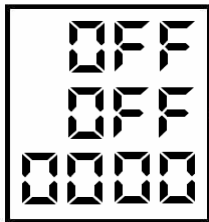

Initial display
when in cali-
bration mode

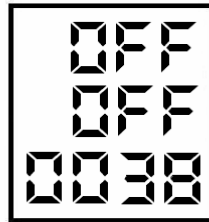

Increase tem-
perature by 38
degrees

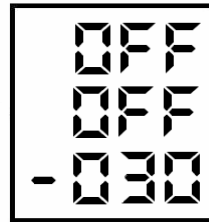

Decrease tem-
perature by 30
degrees

Solder Iron Digital Temperature Calibration Example

- The external temperature sensor displays 248 to 252 degrees.
- The set temperature and displayed actual temperature of the soldering iron is 300 degrees.
- $300 - 248 = 52$. An additional adjustment of 52 degrees is required.
- Enter calibration mode
- We increase from "0000" to "0052".
- Exit calibration mode.
- The external temperature sensor would now display 298 to 302 degrees.

OPERATING GUIDELINES

IMPORTANT REMINDERS:

- Make sure the equipment is placed on a flat stable surface and all the heat-generating components placed on their respective holders or stands.
- Ensure all function switches are OFF prior to reworking.
- Ensure all terminal connections are properly secured.

IMPORTANT: Please refer to the **CONTROL PANEL GUIDE** page for buttons and display panel directory.

A. INITIAL PROCEDURES

- Plug the device to the main power source using the power cord provided in the package.
- With all function switches deactivated and all terminal connections properly secured, switch ON the device by activating the main power switch ("8" from the control panel).
- The display panels, 11 and 12 will temporarily show the product name in a scrolling manner and then display "OFF" on all rows once the scroll is finished (see below illustration). The system will remain at this state until the user activates a function.

B. HOT AIR GUN

- Follow the initial procedures above, "**A. INITIAL PROCEDURES**".
- Activate "Hot Air Gun" switch ("14" from the control panel).
- The system will immediately start to blow air at an airflow rate of **50** while rapidly and safely increasing the air temperature to **100°C** (default system operating parameters). These values will be reflected from the Hot Air Gun Air Temperature and Air Pressure display panels, "13" and "12" from the control panel, respectively. The metal ball inside the air gauge ("1" from the control panel) will also settle somewhere in the middle of the visible area indicating that the system is blowing air at an average or normal rate.

OPERATING GUIDELINES

- Adjust the air flow level using the AIR PRESSURE ADJUSTMENT BUTTONS ("3" from the control panel).
- Adjust the hot air gun air temperature using the HOT AIR GUN TEMPERATURE ADJUSTMENT BUTTONS ("2" from the control panel). The prefix of the display for Hot Air Gun Temperature will change from "H" to "h" indicating that air temperature is being adjusted. It will return to "H" (indicating actual temperature) while the temperature is gradually increasing or decreasing until the desired temperature is reached.

⚠ IMPORTANT: When adjusting the air temperature, it is strongly advised to initially increase the airflow level in order to manage the system temperature. This is to protect the heating element inside the handle from excessive heat and avoid the possibility of subjecting adjacent components to thermal shock.

- Reworking task can be started 1 minute after the desired hot air temperature and airflow level are reached, as also indicated from display panels "11" and "12", respectively.
- When reworking is complete, return the Hot Air Gun to its holder and **DO NOT** immediately turn off the main power switch.
- Deactivate the Hot Air Gun Activation button first in order to activate the auto-cooling process. The system will start to blow air (at room temperature) at a fast rate to reduce heat from the hot air gun and bring down the temperature to a reasonable safe level of **90°C**. During this time, the prefix of the display for hot air gun temperature will also change from "H" to "C" while temperature is gradually decreasing. Likewise, the air pressure level is at its highest reading as indicated from the display panel. Once the temperature drops to approximately **90°C** the system will halt and display "OFF" on the panel. It is now safe to switch off the main power switch.
- Turn OFF the main power switch.
- Unplug the device from the main power source.

DIGITAL CALIBRATION

- Release the two buttons after the change in display.
- Use the same two buttons to adjust the countdown time. "**t001**" means solder iron will go to sleep in 1 minute. Timer is adjustable from 1 to 60minutes.
- Confirm the change by activating the SOLDERING IRON switch.
- To **DEACTIVATE** this feature, simply follow the above procedures. This time, select "**tOFF**".
- During sleep mode, the soldering iron temperature display panel will show an all-dash, "- - - -".
- To wake the soldering iron from sleep mode, press the soldering iron temperature adjustment buttons.

H. Utilizing the Solder Iron Digital Temperature Calibration

By default, the system is properly calibrated but for some cases when a little adjustment of the soldering iron temperature is required the following procedure can be done.

- Turn on the soldering iron function switch.
- Set to appropriate temperature you want to calibrate. Place the tip of the soldering iron on an external temperature sensor.
- The readings on the external temperature sensor should be more or less equal to the displayed temperature.
- If there are large discrepancy in the temperature reading we can re-calibrate the temperature setting.
- While the solder iron is operating make sure the hot air gun is in off mode ("**OFF**" is displayed on the panels "6" and "7"), hold the air pressure **UP** button for a few seconds until four zeroes are displayed "0000".

AUTO SLEEP FUNCTIONS

1. While the hot air gun is on stand-by mode ("**OFF**" is displayed on the panels "13" and "12"), hold both **UP** and **DOWN** buttons of the HOT AIR GUN TEMPERATURE adjustment buttons.
2. Wait until "**t005**" is displayed on the Hot Air Gun Temperature display panel, "13".
3. Release the buttons when "**t005**" appears.
4. Adjust the time using the same **UP** and **DOWN** buttons of the HOT AIR GUN TEMPERATURE adjustment buttons.
5. Confirm the change by activating the HOT AIR GUN function switch.
6. The system will immediately switch back to operation and use the defined countdown parameter for the entire usage.

NOTES:

- The sleep mode timer is configurable between **1** and **30** minutes.
- Sleep mode settings for Hot-Air gun and Soldering Iron is saved into the memory and shall remain effective until it is reset or new data is entered.

G. Activating Soldering Iron Auto-Sleep Mode

The soldering iron's SLEEP mode is deactivated by default. Follow the set of procedures below to activate this feature.

CONDITION: SOLDERING IRON function is inactive.

1. While soldering iron is displaying "**OFF**" or in stand-by mode, push both UP and DOWN buttons of the SOLDERING IRON TEMPERATURE adjustment buttons ("4" from the CONTROL PANEL GUIDE page).
2. Wait until "**tOFF**" appears from soldering iron temperature display panel. This means sleep mode is currently turned OFF.

OPERATING GUIDELINES

NOTES:

1. Hot Air Gun Temperature is adjustable between **100°** and **480°C** with an increment of **2°** on each step.
2. Hot Air Gun Airflow Rate is adjustable between **10** and **100** with an increment of **2** on each step.

C. SOLDERING IRON

1. Connect the Soldering Iron connection assembly to the 6-pin receptacle located at the front of the control panel ("7" from the CONTROL PANEL GUIDE).
2. Follow the initial procedures ("**A. INITIAL PROCEDURES**").
3. Connect the vacuum tube to the Smoke Absorber Terminal or Vacuum Cap ("6" from the control panel). If smoke absorber function is to be used.
4. Activate the "SOLDER IRON" Activation switch ("9" from control panel). This will automatically start to increase the temperature of the soldering iron to **350°C** (default).
5. Adjust the soldering iron temperature using the SOLDER/DESOLDER TEMPERATURE ADJUSTMENT buttons ("4" from the control panel).
6. If smoke absorber function is to be used. Activate the "SMOKE ABSORBER" Activation switch ("11" from the control panel).
7. Start using the soldering iron as soon as desired temperature is reached.
8. When the task is finished, deactivate the SMOKE ABSORBER switch.
9. Deactivate the SOLDER IRON activation switch.
10. Allow sufficient time for the soldering iron to cool down before keeping in a safe storage.

D. DESOLDERING GUN

1. Connect the De-soldering gun connection assembly to the 6-pin receptacle located at the front of the control panel ("7" from the CONTROL PANEL GUIDE).
2. Follow the initial procedures ("**A. INITIAL PROCEDURES**").

OPERATING GUIDELINES

3. Connect the vacuum tube to the Smoke Absorber Terminal or Vacuum Cap ("6" from the control panel). If smoke absorber function is to be used.
4. Activate the "SOLDER IRON" Activation switch ("9" from control panel). This will automatically start to increase the temperature of the desoldering gun to **350°C** (default).
6. Adjust the desoldering gun temp. using the SOLDER/DESOLDER TEMPERATURE ADJUSTMENT buttons ("4" from the control panel).
7. Allow the desoldering gun's tip and its barrel to heat up. Tip temperature can be reached within 5-6 minutes and its barrel would obtain optimum temperature 5-9 minutes after the tip temperature has been reached. If upon initial use solder gets stuck at the end of the barrel, clean the barrel and wait a few more minutes for the barrel to heat up.
8. Check the tip temperature with an external temperature sensor, adjust temperature settings higher or lower for the right temperature. Or recalibrate at the desired temperature level
9. Ensure that all the solder is melted before triggering the pump. (Partially melted solder will still be sucked up however it would clog the barrel).
10. Upon pressing the pump trigger hold the trigger for 1 to 2 seconds longer, as larger lumps of solder may need a longer suction time to clear the barrel and go into the filter.
11. Clean the filter and dampen the sponge frequently during and after usage to allow better suction power.
12. When the task is finished, deactivate the SOLDER IRON switch. Allow the desoldering gun to cool down before handling for storage.

Notes:

- Please follow the procedures and tips presented above for more efficient usage of the desoldering gun.
- Industry recommended tip temperature for soldering is 600 to 610F (315 to 320C) for standard solders and 650 to 700F (340 to 370) for unleaded solders

AUTO SLEEP FUNCTIONS

- The soldering iron and desoldering gun operating temperature is configurable between 200°C and 480°C
- Because of the difference in the heating element and size of the soldering iron tip and desoldering gun, the soldering iron will heat up faster than the desoldering gun. This is normal and does not have any impact on the system's performance.
- There will be a slight drop in temperature display once the trigger of the desoldering gun is used. This is due to rapid intake of air in which temperature is significantly cooler than the desoldering gun tip. When the system detects this, it will automatically adjust the temperature to compensate for the temperature difference.



IMPORTANT: Make sure the SMOKE ABSORBER switch is deactivated while using the desoldering gun. Otherwise, the desoldering gun will keep on sucking air indefinitely.

E. Auto-Sleep Mode (Hot Air Gun)

The device has a built-in auto-sleep mode feature such that if the Hot Air Gun sits on its handle and remained idle after a certain period (the prefix of the display for Hot Air Gun air temperature will also change from "H" to "L") , the device will switch to sleep mode. This mechanism is triggered by a countdown timer so when the time has elapsed, the system will blow air (at room temperature) at maximum rate in order to bring down the temperature. During this time, the prefix of the display for Hot Air Gun air temperature will also change from "L" to "C". Once the temperature drops to approximately 90°C, the Hot Air Gun will automatically stop and show an all-dash " - - - - "display indicating that the system is now on sleep mode.

F. Changing SLEEP Mode Timer (HOT AIR GUN)

By default, the system has 5-minute countdown time before the hot air gun goes to sleep mode. This can be altered by the following procedure.