

Click to
ORDER
samples

AME25-277PEVZ



Encapsulated

The AME25-277PEVZ is a whole new AC/DC converter that offers much greater cost effectiveness due to material normalization and production automation also leading to improved reliability and performance. Offering a commercial input voltage range of 85-305VAC and an output voltage range from 3.3-24V, this series will offer many benefits to your new system design.

This new series offers great operating temperatures from -40°C to 85°C, also features an isolation of 4200VAC for improved reliability and system safety. Furthermore, a higher MTBF of 500,000h, output short circuit protection (OSCP), output over-current protection (OCP) and an output over-voltage protection (OVP) come standard with the series.

The AME25-277PEVZ is perfect for street lighting controls, grid power, EVSE, industrial controls, UPS, battery storage system and energy management applications.

Features

- Universal Input: 85 - 305VAC/100 - 430VDC
- Operating Temp: -40 °C to +85 °C
- High isolation voltage: 4200VAC
- Low ripple & noise, 50mV(p-p), typ.
- Output short circuit, over-current, over-voltage protection
- Regulated Output

Summary

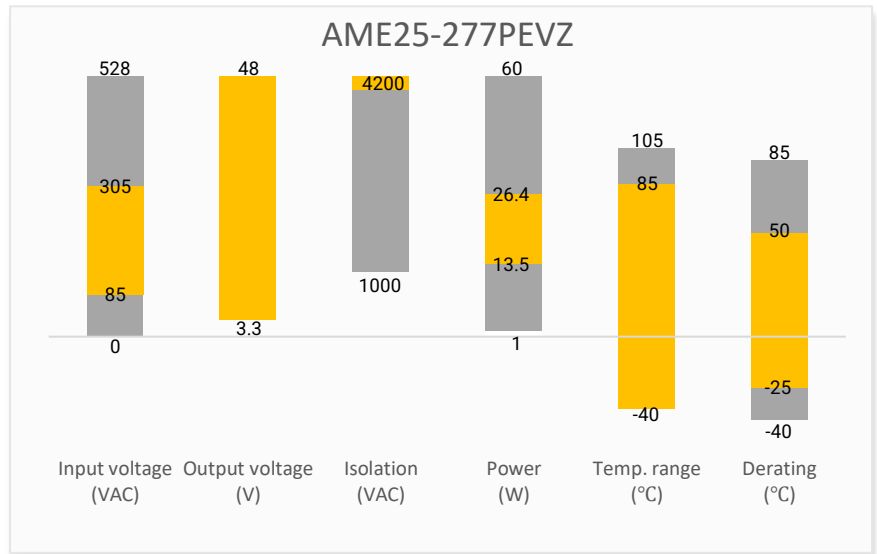

Training

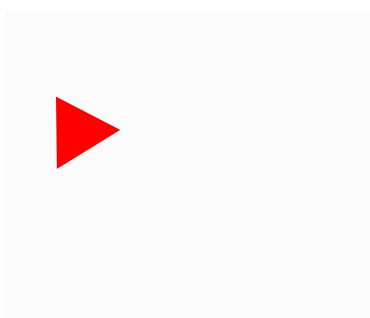

Product Training Video
(click to open)

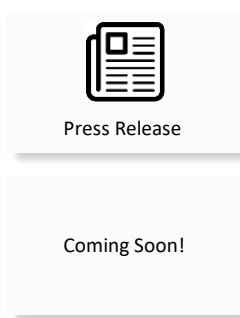

Application Notes

Applications



Power Grid



Industrial



Telecom



Instrumentation

Models & Specifications

| Single Output | | | | | | | |
|--------------------|------------------------|---------------------|------------------------|--------------------|------------------------|------------------------------|-------------------------|
| Model | Input Voltage (VAC/Hz) | Input Voltage (VDC) | Max Output wattage (W) | Output Voltage (V) | Output Current max (A) | Maximum capacitive load (μF) | Efficiency @ 230VAC (%) |
| AME25-3S277PEVZ | 85-305/47-63 | 100-430 | 13.5 | 3.3 | 4.1 | 48000 | 78 |
| AME25-5S277PEVZ | 85-305/47-63 | 100-430 | 20.5 | 5 | 4.1 | 12240 | 82 |
| AME25-9S277PEVZ # | 85-305/47-63 | 100-430 | 22.5 | 9 | 2.5 | 5600 | 82 |
| AME25-12S277PEVZ # | 85-305/47-63 | 100-430 | 25 | 12 | 2.1 | 5400 | 84 |
| AME25-15S277PEVZ | 85-305/47-63 | 100-430 | 24 | 15 | 1.6 | 2400 | 85 |
| AME25-24S277PEVZ | 85-305/47-63 | 100-430 | 26.4 | 24 | 1.1 | 1440 | 85 |
| AME25-48S277PEVZ | 85-305/47-63 | 100-430 | 24 | 48 | 0.5 | 600 | 87 |

Note: Use suffix "ST" for chassis and suffix "STD" for DIN-Rail mounting (ex. AME25-3S277PEVZ-ST is chassis mounting and AME25-3S277PEVZ-STD is DIN-Rail mounting version).

| Input Specifications | | | | | |
|----------------------|---------------------|---------|---------|---------|----------|
| Parameters | Conditions | Minimum | Typical | Maximum | Units |
| Current | 115VAC | | | 0.6 | A |
| | 230VAC | | | 0.34 | A |
| Inrush current | 115VAC | | 20 | | A |
| | 230VAC | | 40 | | A |
| Leakage current | 270V/50Hz | | | 0.25 | mA (RMS) |
| External fuse | slow blow type,300V | | 3.15 | | A |

| Output Specifications | | | | |
|-----------------------|-----------------|---------|---------|-------------------|
| Parameters | Conditions | Typical | Maximum | Units |
| Voltage accuracy | 3.3V output | ±3 | | % |
| | Others | ±2 | | % |
| Line regulation | Full load | ±0.5 | | % |
| Load regulation | 0-100% load | ±1 | | % |
| Ripple & Noise* | 20MHz bandwidth | 50 | 100 | mV _{p-p} |
| Hold up time | 115VAC | 10 | | ms |
| | 230VAC | 60 | | ms |

* Ripple and Noise are measured at 20MHz bandwidth by using the referenced Application circuit.

| Isolation Specifications | | | | |
|--|---|---------|-------|-------|
| Parameters | Conditions | Typical | Rated | Units |
| Tested I/O voltage | 60 sec, leakage current < 5mA | | 4200 | VAC |
| Tested Input to PE voltage | 60 sec, leakage current < 5mA | | 2500 | VAC |
| Tested Output to PE voltage | 60 sec, leakage current < 5mA | | 1250 | VAC |
| Impulse voltage (I/O, Input/PE, Output/PE) | Apply 6kV impulse test voltage. Add 1.2/50us impact waveform, including three positive impulse and three negative impulse, whose time interval is no less than 5 seconds. | | 6000 | V |
| Insulation resistance (I/O, Input/PE, Output/PE) | 500VDC | | ≥ 100 | MΩ |

| General Specifications | | | | |
|---|---|--|---------|-----------------------|
| Parameters | Conditions | Typical | Maximum | Units |
| Safety class | Class I | | | |
| Overvoltage category | OVC III; Per IEC 62477, 2000m | | | |
| Over Current protection | Auto recovery | ≥ 150 | | % of I _{out} |
| Over voltage protection | 3.3V / 5V V _{out} | | 7.5 | VDC |
| | 9V V _{out} | | 15 | VDC |
| | 12V /15V V _{out} | | 20 | VDC |
| | 24V V _{out} | | 30 | VDC |
| | 48V V _{out} | | 60 | VDC |
| Short circuit protection | Hiccup, Continuous, Auto recovery | | | |
| Operating temperature | See derating graph | -40 to +85 | | °C |
| Storage temperature | | -40 to +105 | | °C |
| Lead temperature | Wave soldering | 260 ± 5 °C; time : 5 - 10s | | |
| | Hand soldering | 360 ± 10 °C; time : 3 - 5s | | |
| Power consumption | 230VAC, Others | | 0.3 | W |
| | 230VAC, 48V V _{out} | | 0.4 | W |
| Power derating | -40 °C ~ -25 °C | 3.33 | | % / °C |
| | 50 °C ~ 70 °C | 2.5 | | % / °C |
| | 70 °C ~ 85 °C | 0.67 | | % / °C |
| | 85VAC ~ 100VAC | 1 | | % / VAC |
| | 277VAC ~ 305VAC | 0.715 | | % / VAC |
| | 2000m – 5000m | 6.67 | | % / Km |
| Temperature coefficient | | ±0.02 | | % / °C |
| Cooling | Free air convection | | | |
| Humidity | Non-condensing | | 95 | % RH |
| Case material | Heat resistant black Plastic (flammability to UL 94V-0) | | | |
| Weight | PCB mountable models | 120 | | g |
| | With optional -ST mounting plate: | 170 | | |
| | With optional -STD mounting plate: | 210 | | |
| Dimensions (L x W x H) | PCB mountable models | 2.76 x 1.89 x 0.93 inches (70.0 x 48.0 x 23.5mm) | | |
| | With optional -ST mounting plate | 3.78 x 2.13 x 1.26 inches (96.1 x 54.0 x 32.0mm) | | |
| | With optional -STD mounting plate | 3.78 x 2.13 x 1.44 inches (96.1 x 54.0 x 36.6mm) | | |
| MTBF | > 300 000 hrs (MIL-HDBK -217F, t=+25°C)/Full Load | | | |
| NOTE: All specifications in this datasheet are measured at an ambient temperature of 25°C, humidity<75%, nominal input voltage and at rated output load unless otherwise specified. | | | | |

Safety Specifications

Parameters

Agency approvals CE EN62368-1; UL 62368-1 (With models marked with # only)

| | | |
|--|--|---|
| Standards | Information technology Equipment | Designed to meet IEC/UL 62368-1, IEC 62477-1 |
| | EMC - Conducted and radiated emission | CISPR32 / EN55032, CLASS B |
| | Electrostatic Discharge Immunity | IEC 61000-4-2 Contact $\pm 8\text{KV}$ / Air $\pm 15\text{KV}$, Criteria A |
| | RF, Electromagnetic Field Immunity | IEC 61000-4-3 10V/m, Criteria A |
| | Electrical Fast Transient/Burst Immunity | IEC 61000-4-4 $\pm 4\text{KV}$, Criteria A |
| | Surge Immunity | IEC 61000-4-5 L-L $\pm 2\text{KV}$ /L-G $\pm 4\text{KV}$, Criteria A |
| | | IEC 61000-4-5 L-L $\pm 4\text{KV}$ /L-G $\pm 6\text{KV}$, with EMC recommended circuit, Criteria A |
| | CS, Conducted Disturbance Immunity | IEC 61000-4-6 10Vr.m.s, Criteria A |
| Voltage dips, Short Interruptions Immunity | IEC 61000-4-11 0%, 70%, Criteria B | |

Derating



Free Air Convection

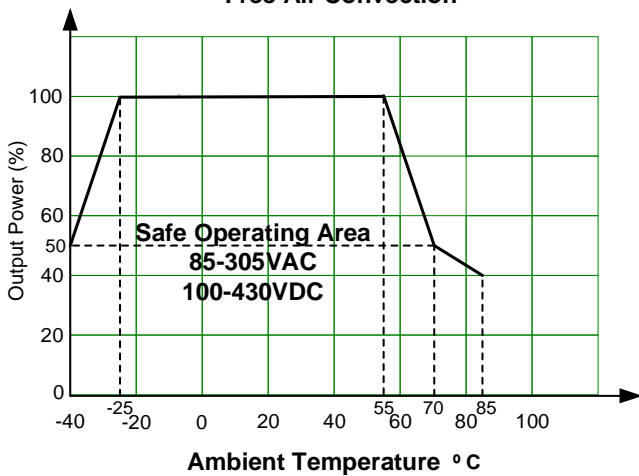

Free Air Convection at 25°C

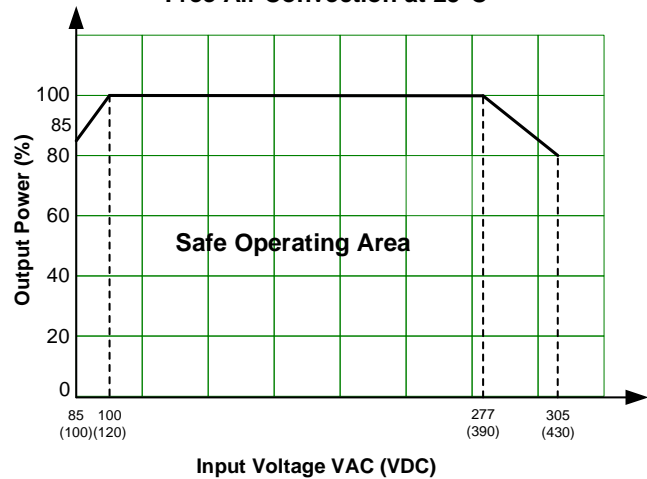

Altitude Derating curve

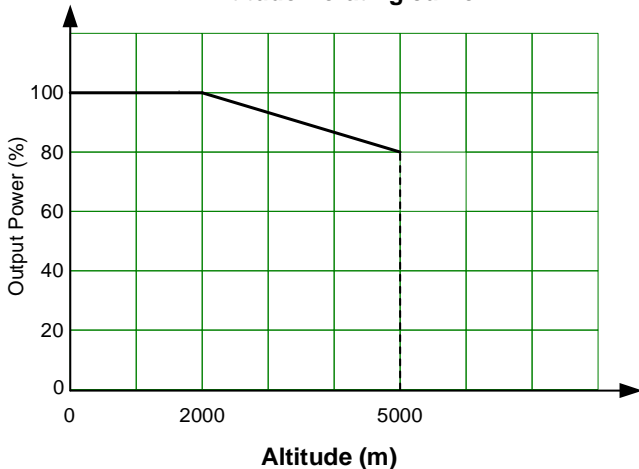

Typical Application Circuit

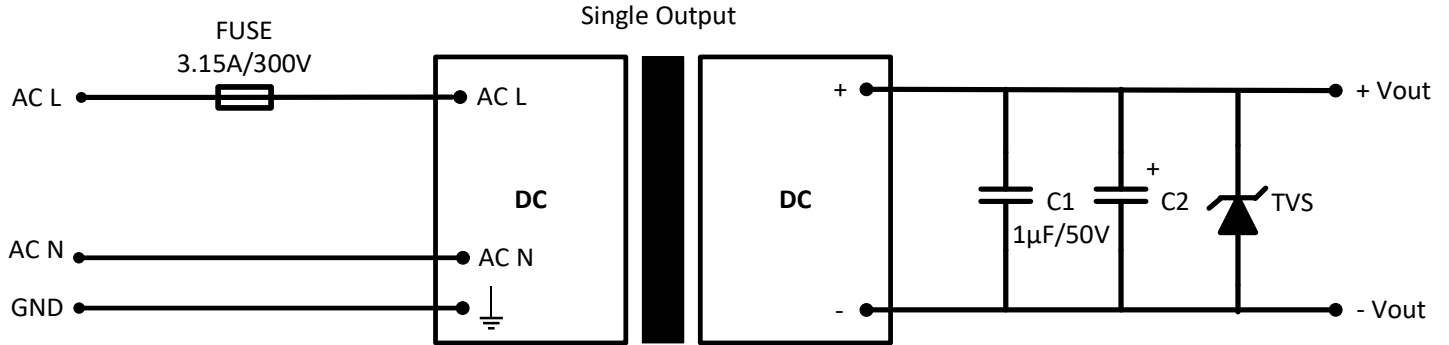

| Model | C2 | TVS |
|---------------|--------------|----------|
| 3.3 / 5V Vout | 330 µF / 16V | SMBJ7.0A |
| 9 Vout | 330 µF / 16V | SMBJ12A |
| 12 / 15 Vout | 330 µF / 25V | SMBJ20A |
| 24 Vout | 120 µF / 35V | SMBJ30A |
| 48 Vout | 68 µF / 63V | SMBJ64A |

Output Filter Components:

We recommend using an electrolytic capacitor with high frequency, and low ESR rating for C2. C1 is a ceramic capacitor used for filtering high-frequency noise and TVS is a recommended suppressor diode.

EMC Recommended Circuit

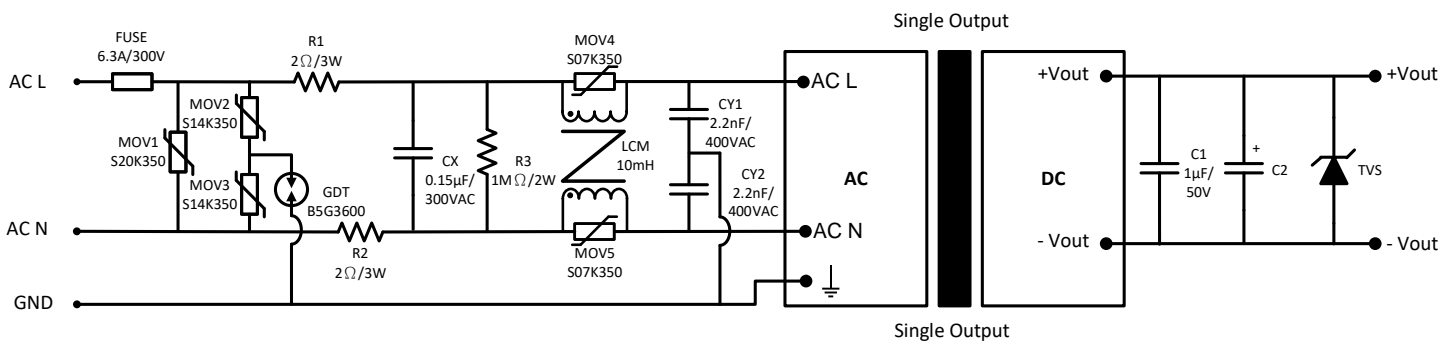

NOTE: R1 & R2 should be wire-wound resistors

Dimensions

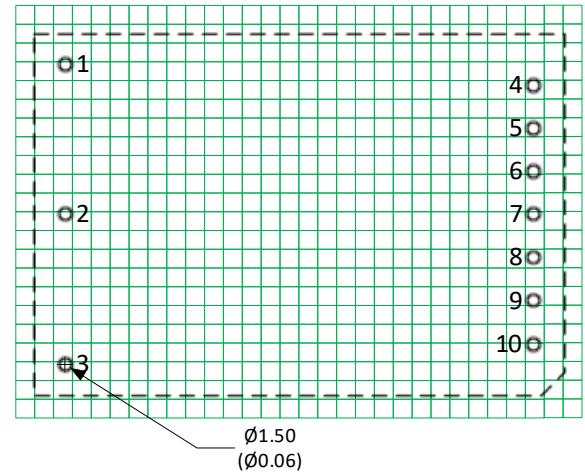
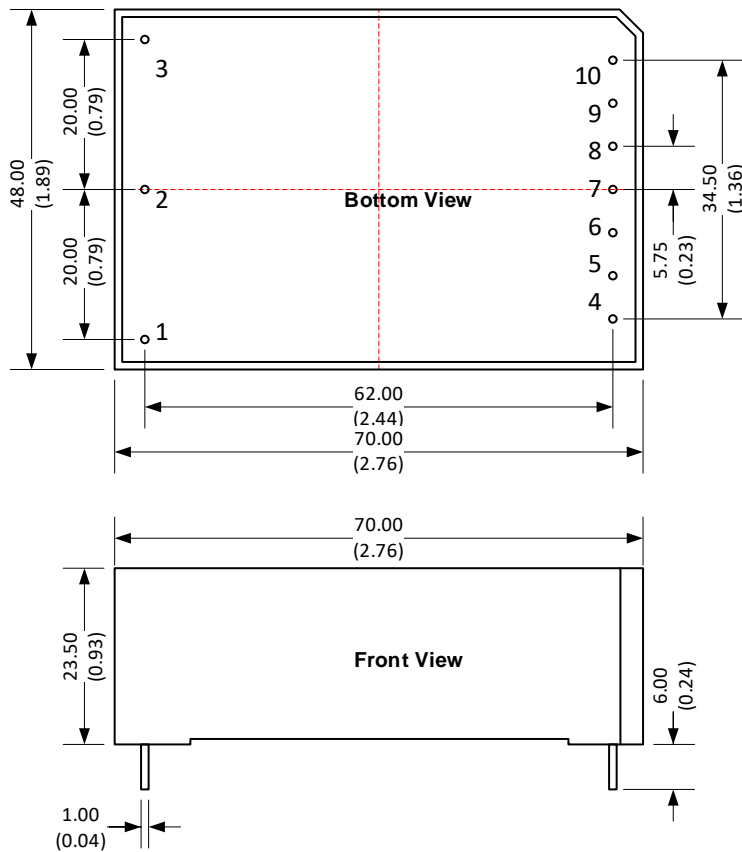

Note : Grid 2.54*2.54 mm

Notes:

All dimensions are typical in millimeters (inches).

Pin diameter tolerances : ± 0.10 (± 0.004)

General tolerance : ± 0.50 (± 0.02)

| Pin Output Specifications | | | |
|---------------------------|--------------|-----|-----------|
| Pin | Single | Pin | Single |
| 1 | Ground | 6 | No pin |
| 2 | AC Input (N) | 7 | No pin |
| 3 | AC Input (L) | 8 | No pin |
| 4 | Trim | 9 | +V Output |
| 5 | -V Output | 10 | No pin |

Dimensions with ST Optional

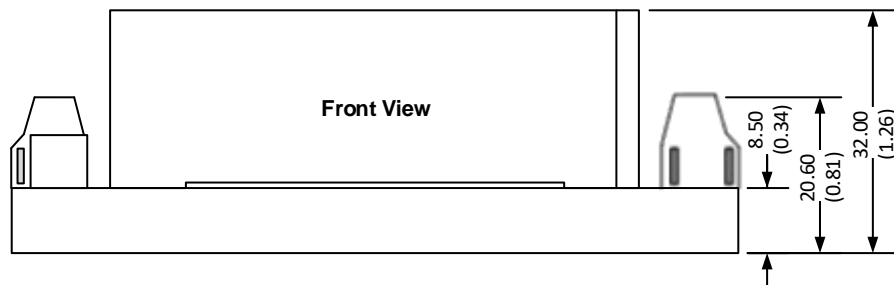
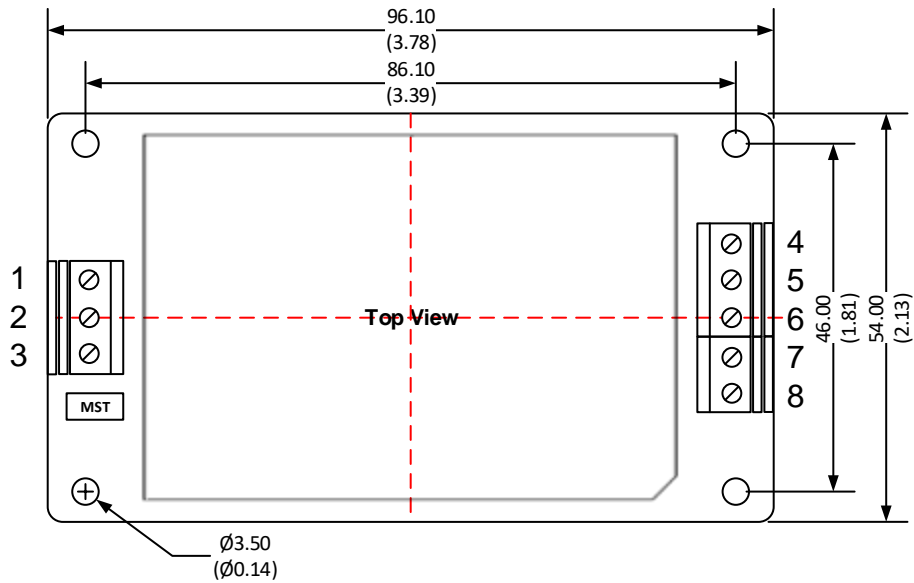

Notes:
All dimensions are typical in millimeters (inches).
Wire range : 24-12 AWG
Tightening torque : Max 0.4 N.m
General tolerance ± 1.00 : (± 0.04)

| Pin Output Specifications | | | |
|---------------------------|--------------|-----|-----------|
| Pin | Single | Pin | Single |
| 1 | Ground | 5 | NC |
| 2 | AC Input (N) | 6 | Trim |
| 3 | AC Input (L) | 7 | NC |
| 4 | -V Output | 8 | +V Output |

Dimensions with STD Optional

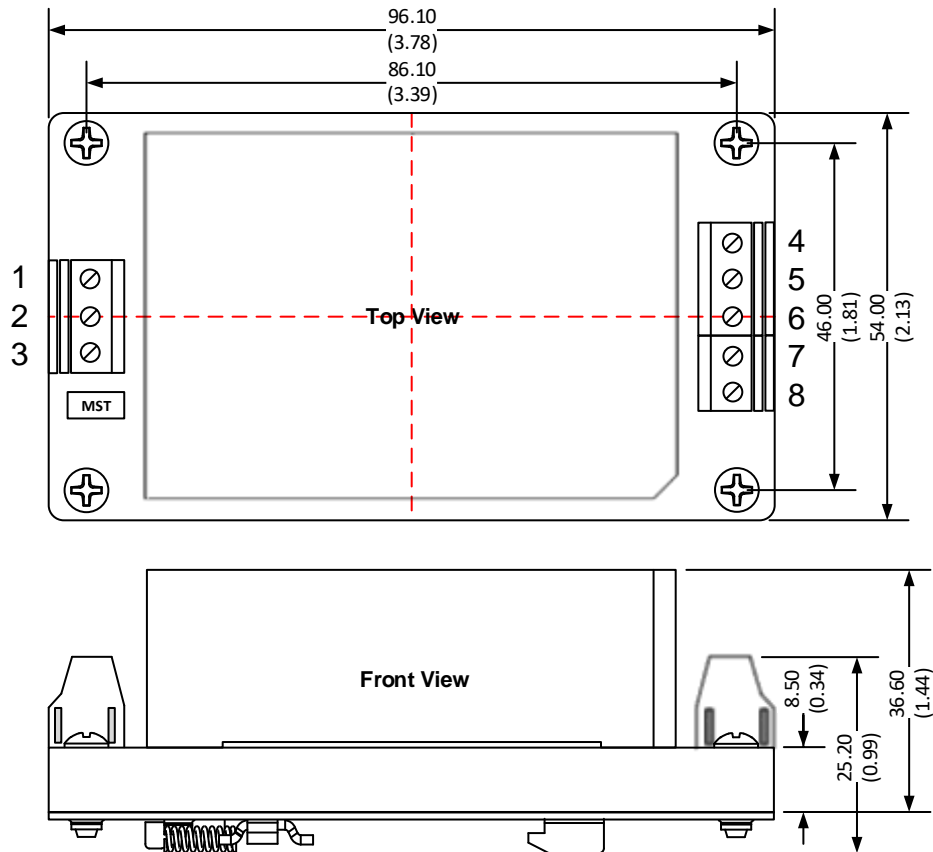

Notes:

All dimensions are typical in millimeters (inches).
 Mounting rail : TS35, rail need to connect safety ground
 Wire range : 24-12 AWG
 Tightening torque : Max 0.4 N.m
 General tolerance ± 1.00 : (± 0.04)

| Pin Output Specifications | | | |
|---------------------------|--------------|-----|-----------|
| Pin | Single | Pin | Single |
| 1 | Ground | 5 | NC |
| 2 | AC Input (N) | 6 | Trim |
| 3 | AC Input (L) | 7 | NC |
| 4 | -V Output | 8 | +V Output |

Trimming



Output voltage can be externally trimmed by utilizing the methods as shown below

Fixed Resistor

Variable Potentiometer

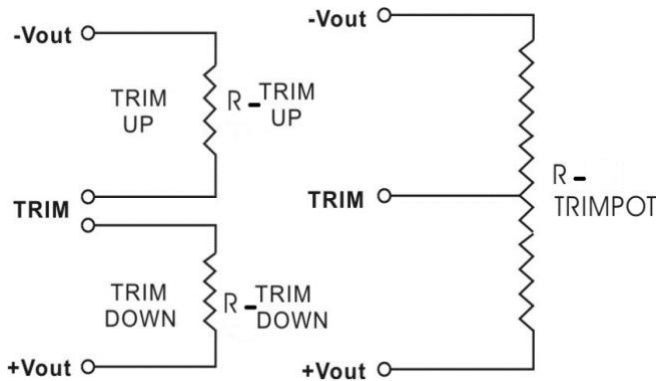

Leave open if not used.

AME25-3S277PEVZ

| Trim down % | 1 | 2 | 3 | 4 | 5 | 6 | 7 | 8 | 9 | 10 |
|--------------|----------|---------|---------|--------|--------|--------|--------|--------|--------|--------|
| Vout (VDC) | 3.267 | 3.234 | 3.201 | 3.168 | 3.135 | 3.102 | 3.069 | 3.036 | 3.003 | 2.970 |
| Rt down (KΩ) | 240.741 | 154.964 | 113.111 | 88.321 | 71.927 | 60.280 | 51.580 | 44.834 | 39.450 | 35.053 |
| Trim up % | 1 | 2 | 3 | 4 | 5 | 6 | 7 | 8 | 9 | 10 |
| Vout (VDC) | 3.333 | 3.366 | 3.399 | 3.432 | 3.465 | 3.498 | 3.531 | 3.564 | 3.597 | 3.630 |
| Rt up (KΩ) | 2987.087 | 256.530 | 133.563 | 90.076 | 67.832 | 54.320 | 45.243 | 38.725 | 33.817 | 29.988 |

AME25-5S277PEVZ

| Trim down % | 1 | 2 | 3 | 4 | 5 | 6 | 7 | 8 | 9 | 10 |
|--------------|----------|---------|---------|---------|--------|--------|--------|--------|--------|--------|
| Vout (VDC) | 4.950 | 4.900 | 4.850 | 4.800 | 4.750 | 4.700 | 4.650 | 4.600 | 4.550 | 4.500 |
| Rt down (KΩ) | 174.844 | 115.508 | 85.188 | 66.781 | 54.419 | 45.545 | 38.864 | 33.654 | 29.476 | 26.052 |
| Trim up % | 1 | 2 | 3 | 4 | 5 | 6 | 7 | 8 | 9 | 10 |
| Vout (VDC) | 5.060 | 5.100 | 5.150 | 5.200 | 5.250 | 5.300 | 5.350 | 5.400 | 5.450 | 5.500 |
| Rt up (KΩ) | 3405.559 | 411.051 | 195.327 | 127.862 | 94.906 | 75.373 | 62.451 | 53.269 | 46.408 | 41.087 |

AME25-9S277PEVZ

| Trim down % | 1 | 2 | 3 | 4 | 5 | 6 | 7 | 8 | 9 | 10 |
|--------------|---------|---------|---------|---------|---------|---------|---------|--------|--------|--------|
| Vout (VDC) | 8.910 | 8.820 | 8.730 | 8.640 | 8.550 | 8.460 | 8.370 | 8.280 | 8.190 | 8.100 |
| Rt down (KΩ) | 682.347 | 378.845 | 259.708 | 196.082 | 156.501 | 129.500 | 109.904 | 95.034 | 83.365 | 73.964 |
| Trim up % | 1 | 2 | 3 | 4 | 5 | 6 | 7 | 8 | 9 | 10 |
| Vout (VDC) | 9.090 | 9.180 | 9.270 | 9.360 | 9.450 | 9.540 | 9.630 | 9.720 | 9.810 | 9.900 |
| Rt up (KΩ) | 485.777 | 200.712 | 126.214 | 91.902 | 72.168 | 59.348 | 50.351 | 43.689 | 38.557 | 34.482 |

AME25-12S277PEVZ

| Trim down % | 1 | 2 | 3 | 4 | 5 | 6 | 7 | 8 | 9 | 10 |
|--------------|----------|---------|---------|---------|---------|---------|---------|---------|---------|---------|
| Vout (VDC) | 11.880 | 11.760 | 11.640 | 11.520 | 11.400 | 11.280 | 11.160 | 11.040 | 10.920 | 10.800 |
| Rt down (KΩ) | 1187.734 | 717.345 | 509.879 | 393.046 | 318.102 | 265.944 | 227.552 | 198.111 | 174.817 | 155.927 |
| Trim up % | 1 | 2 | 3 | 4 | 5 | 6 | 7 | 8 | 9 | 10 |
| Vout (VDC) | 12.120 | 12.240 | 12.360 | 12.480 | 12.600 | 12.720 | 12.840 | 12.960 | 13.080 | 13.200 |
| Rt up (KΩ) | 1184.255 | 350.655 | 205.454 | 145.120 | 112.075 | 91.219 | 76.859 | 66.369 | 58.369 | 52.068 |

AME25-15S277PEVZ

| Trim down % | 1 | 2 | 3 | 4 | 5 | 6 | 7 | 8 | 9 | 10 |
|--------------|----------|---------|---------|---------|---------|---------|---------|---------|---------|---------|
| Vout (VDC) | 14.850 | 14.700 | 14.550 | 14.400 | 14.250 | 14.100 | 13.950 | 13.800 | 13.650 | 13.500 |
| Rt down (KΩ) | 893.077 | 571.417 | 417.212 | 326.705 | 267.184 | 225.063 | 193.684 | 169.404 | 150.057 | 134.280 |
| Trim up % | 1 | 2 | 3 | 4 | 5 | 6 | 7 | 8 | 9 | 10 |
| Vout (VDC) | 15.150 | 15.300 | 15.450 | 15.600 | 15.750 | 15.900 | 16.050 | 16.200 | 16.350 | 16.500 |
| Rt up (KΩ) | 2105.383 | 286.791 | 153.446 | 104.544 | 79.162 | 63.621 | 53.128 | 45.566 | 39.858 | 35.397 |

AME25-24S277PEVZ

| Trim down % | 1 | 2 | 3 | 4 | 5 | 6 | 7 | 8 | 9 | 10 |
|--------------|-----------|---------|---------|---------|---------|---------|---------|---------|---------|---------|
| Vout (VDC) | 23.760 | 23.520 | 23.280 | 23.040 | 22.800 | 22.560 | 22.320 | 22.080 | 21.840 | 21.600 |
| Rt down (KΩ) | 1063.929 | 700.514 | 518.971 | 410.098 | 337.538 | 285.720 | 246.862 | 216.643 | 192.470 | 172.694 |
| Trim up % | 1 | 2 | 3 | 4 | 5 | 6 | 7 | 8 | 9 | 10 |
| Vout (VDC) | 24.240 | 24.480 | 24.720 | 24.960 | 25.200 | 25.440 | 25.680 | 25.920 | 26.160 | 26.400 |
| Rt up (KΩ) | 68999.000 | 248.097 | 123.774 | 82.233 | 61.443 | 48.964 | 40.642 | 34.696 | 30.236 | 26.767 |

AME25-48S277PEVZ

| Trim down % | 1 | 2 | 3 | 4 | 5 | 6 | 7 | 8 | 9 | 10 |
|--------------|----------|---------|---------|---------|---------|---------|---------|---------|---------|---------|
| Vout (VDC) | 47.520 | 47.040 | 46.560 | 46.080 | 45.600 | 45.120 | 44.640 | 44.160 | 43.680 | 43.200 |
| Rt down (KΩ) | 1352.055 | 871.467 | 639.143 | 502.197 | 411.899 | 347.882 | 300.130 | 263.143 | 233.650 | 209.583 |
| Trim up % | 1 | 2 | 3 | 4 | 5 | 6 | 7 | 8 | 9 | 10 |
| Vout (VDC) | 48.480 | 48.960 | 49.440 | 49.920 | 50.400 | 50.880 | 51.360 | 51.840 | 52.320 | 52.800 |
| Rt up (KΩ) | 1094.199 | 123.623 | 65.071 | 43.951 | 33.063 | 26.421 | 21.946 | 18.727 | 16.300 | 14.405 |

NOTE: **1.** Datasheets are updated as needed and as such, specifications are subject to change without notice. Once printed or downloaded, datasheets are no longer controlled by Aimtec; refer to www.aimtec.com for the most current product specifications. **2.** Product labels shown, including safety agency certifications on labels, may vary based on the date manufactured. **3.** Mechanical drawings and specifications are for reference only. **4.** All specifications are measured at an ambient temperature of 25°C, humidity<75%, nominal input voltage and at rated output load unless otherwise specified. **5.** Aimtec may not have conducted destructive testing or chemical analysis on all internal components and chemicals at the time of publishing this document. CAS numbers and other limited information are considered proprietary and may not be available for release. **6.** This product is not designed for use in critical life support systems, equipment used in hazardous environments, nuclear control systems or other such applications which necessitate specific safety and regulatory standards other the ones listed in this datasheet. **7.** Warranty is in accordance with Aimtec's standard Terms of Sale available at www.aimtec.com.