

ADR3625/ADR3630/ADR3650

Precision, Micropower, High Current Output Voltage References

FEATURES

- ▶ Maximum temperature coefficient
 - ▶ 3 ppm/°C (B grade)
 - ▶ 6 ppm/°C (A grade)
- ▶ Output current capacity (typical): 70 mA sourcing and 20 mA sinking
- ▶ Low quiescent current: 65 μ A
- ▶ Low shutdown current: 1.5 μ A
- ▶ Output voltage noise (0.1 Hz to 10 Hz): 3 ppm p-p
- ▶ Maximum initial output voltage error
 - ▶ $\pm 0.04\%$ (B grade)
 - ▶ $\pm 0.08\%$ (A grade)
- ▶ Operating temperature range: -40°C to $+125^{\circ}\text{C}$
- ▶ Maximum input voltage: 16 V
- ▶ Low dropout voltage
 - ▶ 0.25 V for the ADR3625
 - ▶ 0.15 V for the ADR3630 and ADR3650
- ▶ 1.8 V logic compatible
- ▶ [8-Lead MSOP package](#)

APPLICATIONS

- ▶ Precision power supplies
- ▶ Portable instrumentation
- ▶ Process transmitters
- ▶ Remote sensors
- ▶ Medical instrumentation
- ▶ Auto battery monitors

GENERAL DESCRIPTION

The ADR3625\ADR3630\ADR3650 are low power, high precision voltage references that feature a maximum temperature coefficient of 3 ppm/°C for the B grade in an 8-lead MSOP. Capable of sourcing up to 70 mA, the ADR3625\ADR3630\ADR3650 are an exceptional replacement to standard low dropout (LDO) regulators. For high accuracy, the output voltage and temperature coefficient are trimmed during production using the Analog Devices, Inc., proprietary DigiTrim[®] technology.

The low thermal hysteresis (7 ppm) and low long-term drift (160 ppm at 3500 Hr) improve system lifetime accuracy. A minimum load capacitance of 0.1 μ F is required for operation. The ADR3625\ADR3630\ADR3650 is specified over the -40°C to $+125^{\circ}\text{C}$ operating temperature range.

PIN CONFIGURATION

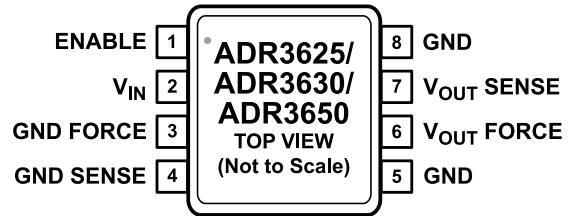

Figure 1. 8-Lead MSOP Pin Configuration

001

Table 1. Voltage Reference Choices from Analog Devices

Micropower	Low Power	High Current
LT6656	ADR391	LT6658
ADR291	LT1460	LT1461
REF192	ADR361	ADR431
LT1461	ADR421	REF192
LT1790	LTC6652	LT1460

TABLE OF CONTENTS

Features.....	1	Long-Term Drift.....	18
Applications.....	1	Theory of Operation.....	19
Pin Configuration.....	1	Power Dissipation.....	19
General Description.....	1	Internal Protection.....	19
Specifications.....	4	Long-Term Drift	20
Electrical Characteristics.....	4	Thermal Hysteresis.....	20
Absolute Maximum Ratings.....	6	Power Cycle Hysteresis.....	20
Thermal Resistance.....	6	Humidity Sensitivity.....	21
Electrostatic Discharge (ESD) Ratings.....	6	Applications Information.....	22
ESD Caution.....	6	Basic Voltage Reference Connection.....	22
Pin Configuration and Function Descriptions.....	7	Input and Output Capacitors.....	22
Typical Performance Characteristics.....	8	Start-Up Time.....	22
Terminology.....	18	Settling Time.....	23
Dropout Voltage.....	18	ENABLE Pin.....	23
Line Regulation.....	18	PCB Layout.....	23
Load Regulation.....	18	Sample Applications	25
Solder Heat Resistance Shift.....	18	Outline Dimensions.....	26
Temperature Coefficient.....	18	Ordering Guide.....	26
Box Method.....	18	Evaluation Boards.....	26
Thermal Hysteresis.....	18		

REVISION HISTORY

4/2023—Rev. 0 to Rev. A

Added ADR3630 and ADR3650 (Universal).....	1
Changes to Features Section and General Description Section.....	1
Changes to Table 2.....	4
Changes to Figure 3 Caption, Figure 6, and Figure 8 Caption.....	8
Added Figure 4, Figure 5, and Figure 7; Renumbered Sequentially.....	8
Deleted Figure 11 and Figure 14; Renumbered Sequentially.....	10
Added Figure 9.....	9
Changes to Figure 10 and Figure 11.....	9
Deleted Figure 16 and Figure 19.....	11
Changes to Figure 18 Caption.....	10
Added Figure 17, Figure 19, and Figure 20.....	10
Added Figure 21, Figure 23, and Figure 24.....	11
Changes to Figure 22 Caption and Figure 25 Caption.....	11
Changes to Figure 27 Caption, Figure 29 Caption, and Figure 31 Caption.....	12
Added Figure 28, Figure 30, and Figure 32.....	12
Changes to Figure 34 Caption, Figure 36 Caption, and Figure 38 Caption.....	13
Added Figure 35 and Figure 37.....	13
Added Figure 39, Figure 41, Figure 43, and Figure 44.....	14
Changes to Figure 40 Caption.....	14
Deleted Figure 42.....	14
Changes to Figure 45 Caption and Figure 48 Caption.....	15
Added Figure 46, Figure 47, Figure 49, and Figure 50.....	15
Changes to Figure 51 Caption.....	16
Added Figure 52 and Figure 53.....	16
Changes to Power Dissipation Section and Figure 62 Caption.....	19

TABLE OF CONTENTS

Changes to Long-Term Drift Section.....	20
Changes to Figure 69, Start-Up Time Section, Figure 70 Caption, and Figure 71 Caption.....	22
Changes to Settling Time Section, Figure 72 Caption Through Figure 75 Caption.....	23
Changes to Figure 81.....	25
Changes to Ordering Guide and Evaluation Boards.....	26

10/2022—Revision 0: Initial Version

SPECIFICATIONS

ELECTRICAL CHARACTERISTICS

Input voltage (V_{IN}) = 3 V to 16 V, output current capacity (I_L) = 0 mA, load capacitance (C_L) = 1 μ F, ENABLE voltage (V_{EN}) = V_{IN} , and $-40^\circ\text{C} \leq T_A \leq +125^\circ\text{C}$, unless otherwise noted.

Table 2. Electrical Characteristics

Parameter	Symbol	Test Conditions/Comments	Min	Typ	Max	Unit
OUTPUT VOLTAGE	V_{OUT}	$T_A = 25^\circ\text{C}$				
A Grade		ADR3625A	2.498	2.500	2.502	V
		ADR3630A	2.998	3.000	3.002	V
		ADR3650A	4.996	5.000	5.004	V
B Grade		ADR3625B	2.499	2.500	2.501	V
		ADR3630B	2.999	3.000	3.001	V
		ADR3650B	4.998	5.000	5.002	V
INITIAL OUTPUT VOLTAGE ERROR	V_{OUT_ERR}	$T_A = 25^\circ\text{C}$				
A Grade					± 0.08	%
B Grade					± 0.04	%
SOLDER HEAT RESISTANCE SHIFT ¹				± 0.06		%
TEMPERATURE COEFFICIENT	TCV_{OUT}	See the Terminology section				
A Grade				4	6	ppm/ $^\circ\text{C}$
B Grade				2	3	ppm/ $^\circ\text{C}$
LINE REGULATION	$\Delta V_{OUT}/\Delta V_{IN}$	$V_{IN} = V_{OUT} + V_{DO}^2$ to 16 V		0.5	2	ppm/V
LOAD REGULATION	$\Delta V_{OUT}/\Delta I_L$					
Sourcing		$I_L = 0$ mA to 10 mA, $V_{IN} = V_{OUT} + V_{DO}^2$		10	15	ppm/mA
		$I_L = 0$ mA to 50 mA, $V_{IN} = V_{OUT} + V_{DO}^3$		3	5	ppm/mA
Sinking		$I_L = 0$ mA to 10 mA, $V_{IN} = V_{OUT} + V_{DO}^2$		20	30	ppm/mA
OUTPUT CURRENT CAPACITY	I_L					
Sourcing		$V_{IN} = V_{OUT} + V_{DO}^3$ to 16 V	50	70		mA
Sinking		$V_{IN} = V_{OUT} + V_{DO}^2$ to 16 V	10	20		mA
Short Circuit to GND		$V_{IN} = 16$ V		90		mA
Short Circuit to V_{IN}		$V_{IN} = 16$ V		70		mA
QUIESCENT CURRENT	I_Q					
Normal Operation		$V_{EN} \geq 1.17$ V				
		ADR3625		65	75	μA
		ADR3630 and ADR3650		70	90	μA
Shutdown		$V_{EN} \leq 0.63$ V		1.5	3	μA
DROPOUT VOLTAGE	V_{DO}					
		ADR3625				
		$I_L = 10$ mA		0.25	0.5	V
		$I_L = 50$ mA		0.8	1	V
		ADR3630 and ADR3650				
		$I_L = 10$ mA		0.15	0.3	V
		$I_L = 50$ mA		0.7	0.9	V
ENABLE PIN						
Input High Voltage	V_{ENH}		1.17			V
Input Low Voltage	V_{ENL}				0.63	V
Leakage Current	V_{ENLEAK}			0.3	1	μA
OUTPUT VOLTAGE NOISE	e_N p-p	$T_A = 25^\circ\text{C}$ 0.1 Hz to 10 Hz		3		ppm p-p
				0.55		ppm RMS

SPECIFICATIONS

Table 2. Electrical Characteristics (Continued)

Parameter	Symbol	Test Conditions/Comments	Min	Typ	Max	Unit
OUTPUT VOLTAGE NOISE DENSITY	e_N	10 Hz to 1 kHz		4		ppm RMS
		$T_A = 25^\circ\text{C}$, 1 kHz				
		ADR3625		300		nV/ $\sqrt{\text{Hz}}$
		ADR3630		360		nV/ $\sqrt{\text{Hz}}$
		ADR3650		600		nV/ $\sqrt{\text{Hz}}$
THERMAL HYSTERESIS	$\Delta V_{\text{OUT_HYS}}$	+25°C to +125°C to -40°C to +25°C (full cycle)		7		ppm
		25°C to 125°C to 25°C (half cycle)		15		ppm
RIPPLE REJECTION RATIO	RRR	$T_A = 25^\circ\text{C}$, input frequency (f_{IN}) = 60 Hz				
		ADR3625 and ADR3630		64		dB
		ADR3650		60		dB
LONG-TERM DRIFT	$\Delta V_{\text{OUT_LTD}}$	$T_A = 25^\circ\text{C}$, relative humidity = 30%				
		250 hours (early life drift)		90		ppm
		1000 hours		140		ppm
		3500 hours		160		ppm
TURN-ON SETTLING TIME	t_R	$T_A = 25^\circ\text{C}$, output capacitor (C_{OUT}) = 0.1 μF , load resistance (R_L) = 1 k Ω				
		ADR3625		600		μs
		ADR3630		700		μs
		ADR3650		900		μs
LOAD CAPACITANCE RANGE		Minimum load capacitance		0.1		μF
		Maximum load capacitance		10		μF

¹ Initial accuracy does not include shift due to solder heat effect (see the [Applications Information](#) section.)

² V_{DO} is the maximum dropout voltage with a 10 mA sourcing load current.

³ V_{DO} is the maximum dropout voltage with a 50 mA sourcing load current.

ABSOLUTE MAXIMUM RATINGS

Table 3. Absolute Maximum Ratings

Parameter	Rating
V_{IN} to GND SENSE	-0.3 V to +18 V
ENABLE to GND SENSE	-0.3 V to +18 V
V_{OUT} FORCE to GND SENSE	-0.3 V to $V_{IN} + 0.3$ V
V_{OUT} SENSE to V_{OUT} FORCE	-0.3 V to +0.3 V
GND FORCE to GND SENSE	-0.3 V to +0.3 V
Temperature	
Storage Range	-65°C to +150°C
Operating Range	-40°C to +125°C
Junction Range	-65°C to +150°C
Lead, Soldering (10 sec)	300°C

Stresses at or above those listed under Absolute Maximum Ratings may cause permanent damage to the product. This is a stress rating only; functional operation of the product at these or any other conditions above those indicated in the operational section of this specification is not implied. Operation beyond the maximum operating conditions for extended periods may affect product reliability.

THERMAL RESISTANCE

Thermal performance is directly linked to printed circuit board (PCB) design and operating environment. Close attention to PCB thermal design is required.

θ_{JA} is the natural convection junction-to-ambient thermal resistance measured in a one cubic foot sealed enclosure, and θ_{JC} is the junction-to-case thermal resistance.

Table 4. Thermal Resistance

Package Type	θ_{JA}	θ_{JC}	Unit
RM-8	132.5	43.9	°C/W

ELECTROSTATIC DISCHARGE (ESD) RATINGS

The following ESD information is provided for handling of ESD-sensitive devices in an ESD protected area only.

Human body model (HBM) per ANSI/ESDA/JEDEC JS-001.

ESD Ratings for ADR3625\ADR3630\ADR3650

Table 5. ADR3625\ADR3630\ADR3650, 8-Lead MSOP

ESD Model	Withstand Threshold (kV)	Class
HBM	1	1C

ESD CAUTION



ESD (electrostatic discharge) sensitive device. Charged devices and circuit boards can discharge without detection. Although this product features patented or proprietary protection circuitry, damage may occur on devices subjected to high energy ESD. Therefore, proper ESD precautions should be taken to avoid performance degradation or loss of functionality.

PIN CONFIGURATION AND FUNCTION DESCRIPTIONS



Figure 2. Pin Configuration

Table 6. Pin Function Descriptions

Pin No.	Mnemonic	Description
1	ENABLE	Enable Connection. The ENABLE pin enables or disables the device.
2	V _{IN}	Input Voltage Connection.
3	GND FORCE	GND Connection.
4	GND SENSE	GND Sensing Connection. Connect GND SENSE directly to the GND connection of the load device.
5	GND	Connect to GND FORCE.
6	V _{OUT} FORCE	Reference Voltage Output.
7	V _{OUT} SENSE	Reference Voltage Output Sensing Connection. Connect V _{OUT} SENSE directly to the voltage input of the load device.
8	GND	Connect to GND FORCE.

TYPICAL PERFORMANCE CHARACTERISTICS

T_A = 25°C, unless otherwise noted.

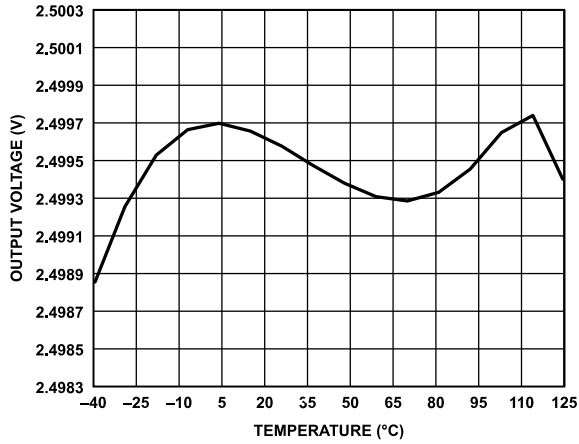

Figure 3. ADR3625 Output Voltage vs. Temperature

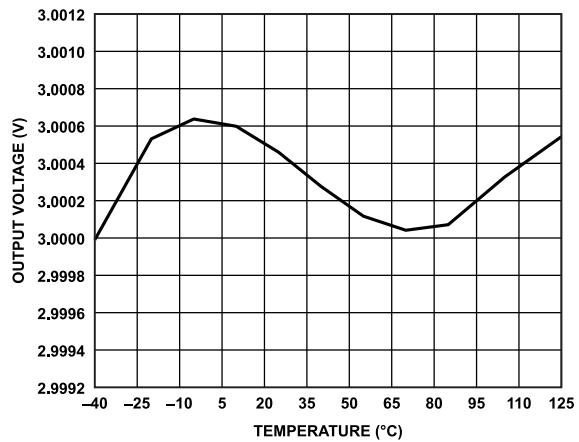

Figure 4. ADR3630 Output Voltage vs. Temperature

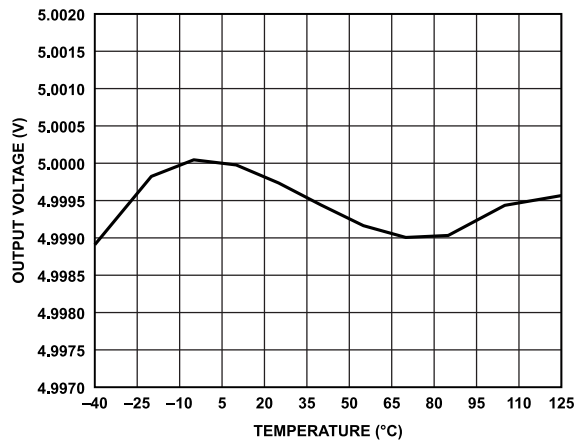

Figure 5. ADR3650 Output Voltage vs. Temperature

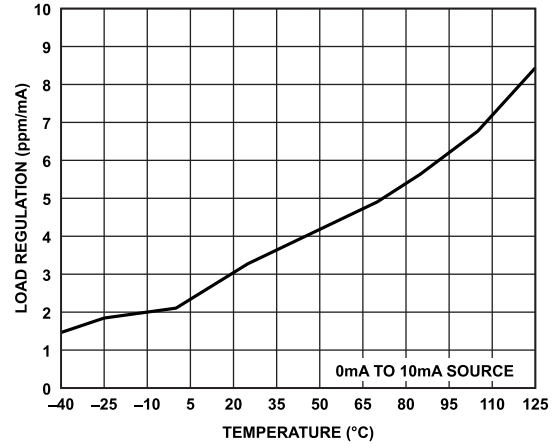

Figure 6. Load Regulation vs. Temperature (0 mA to 10 mA Sourcing)

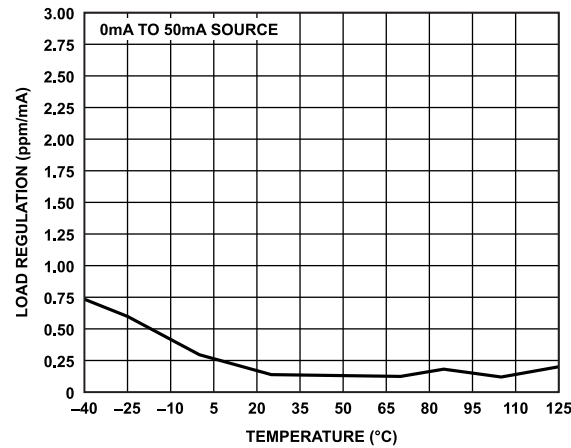

Figure 7. Load Regulation vs. Temperature (0 mA to 50 mA Sourcing)

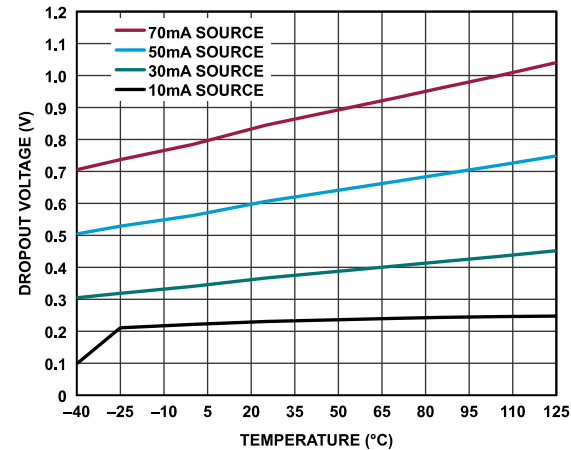

Figure 8. ADR3625 Dropout Voltage vs. Temperature

TYPICAL PERFORMANCE CHARACTERISTICS

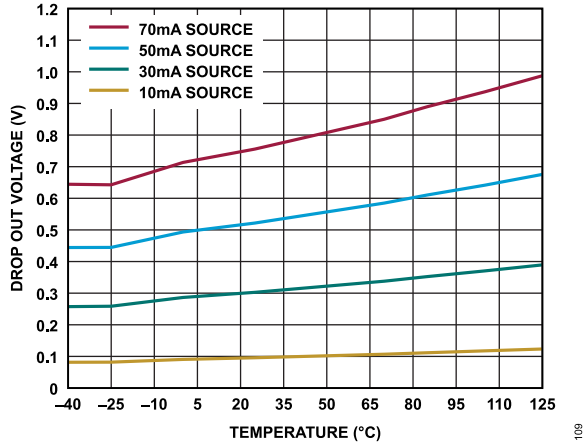

Figure 9. ADR3630/ADR3650 Dropout Voltage vs. Temperature

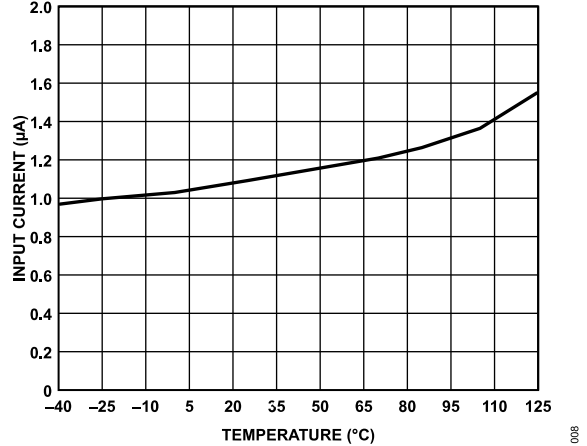

Figure 12. Input Current (Shutdown) vs. Temperature

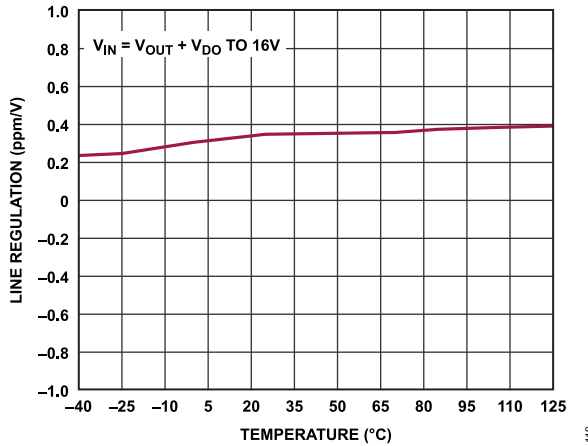

Figure 10. Line Regulation vs. Temperature

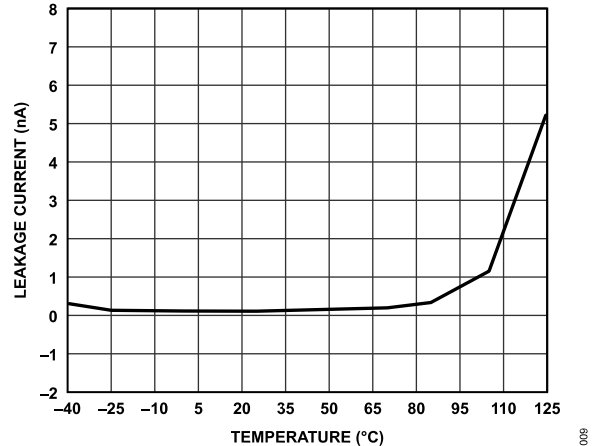

Figure 13. Leakage Current vs. Temperature

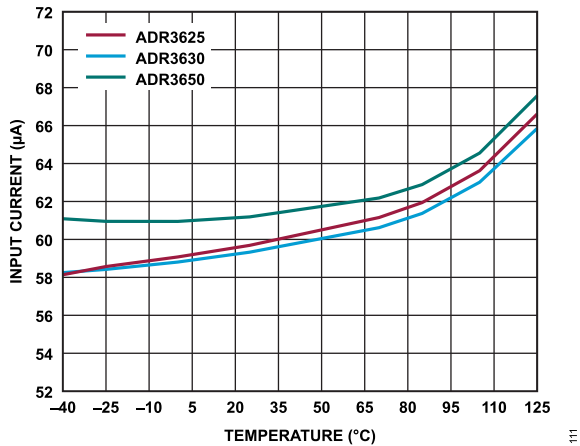

Figure 11. Input Current vs. Temperature

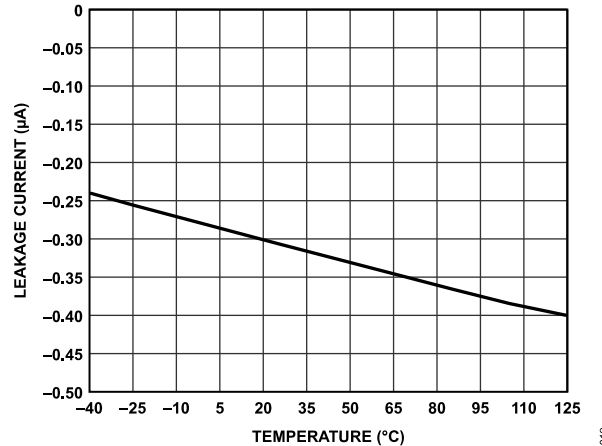

Figure 14. Leakage Current (Shutdown) vs. Temperature

TYPICAL PERFORMANCE CHARACTERISTICS

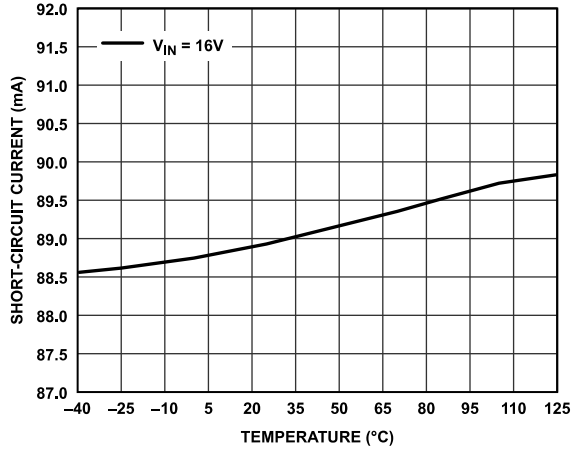

Figure 15. Short-Circuit Current (Source) vs. Temperature

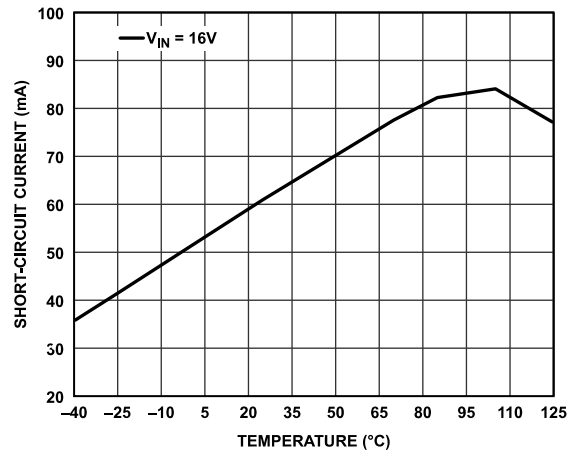

Figure 16. Short-Circuit Current (Sink) vs. Temperature

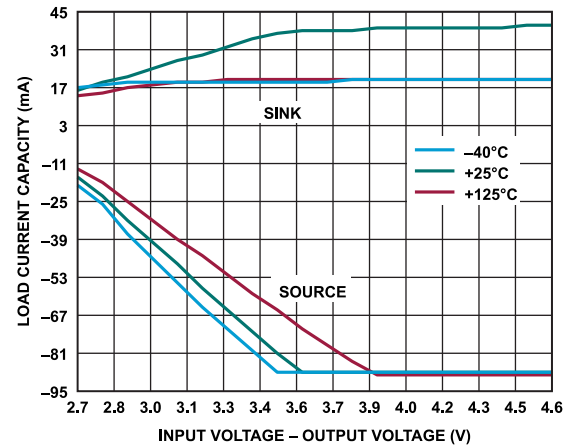

Figure 17. Load Current Capacity vs. Voltage Difference

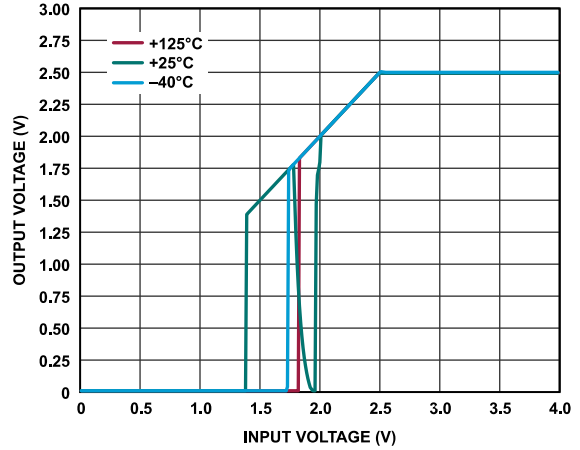

Figure 18. ADR3625 Output Voltage vs. Input Voltage

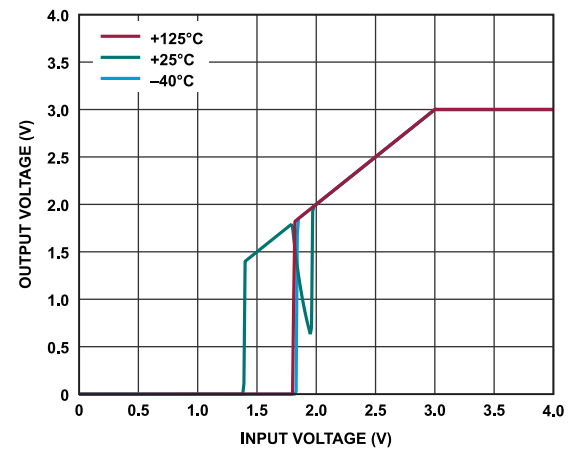

Figure 19. ADR3630 Output Voltage vs. Input Voltage

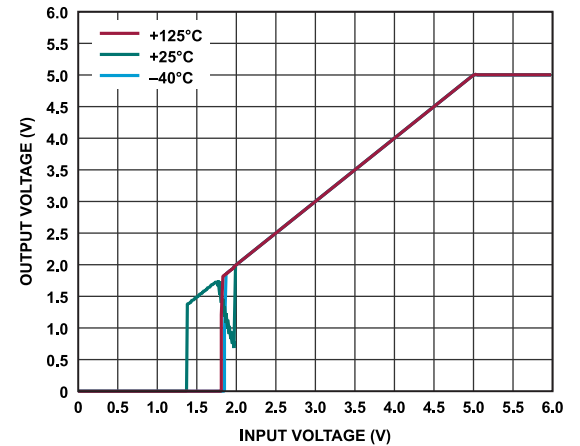

Figure 20. ADR3650 Output Voltage vs. Input Voltage

TYPICAL PERFORMANCE CHARACTERISTICS

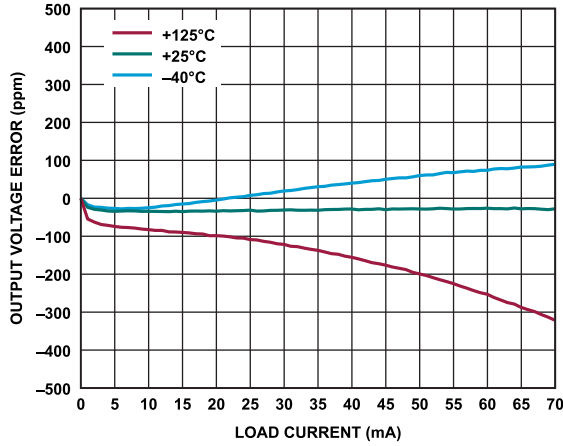

Figure 21. Output Voltage Error vs. Load Current

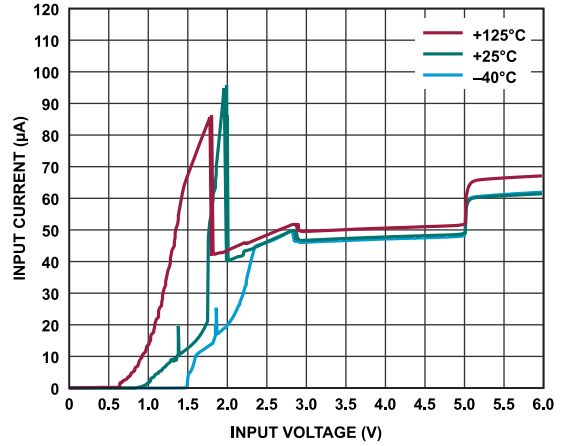

Figure 24. ADR3650 Input Current vs. Input Voltage

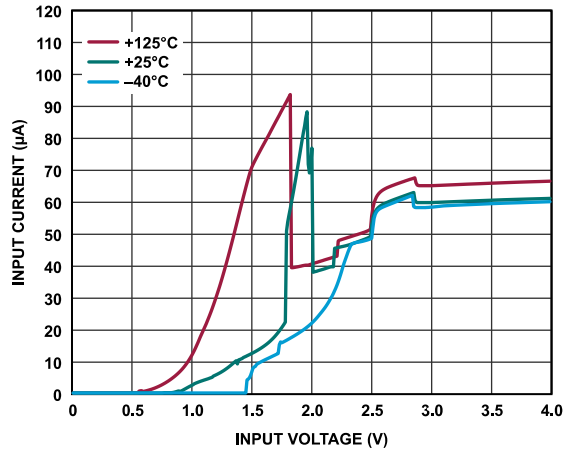

Figure 22. ADR3625 Input Current vs. Input Voltage

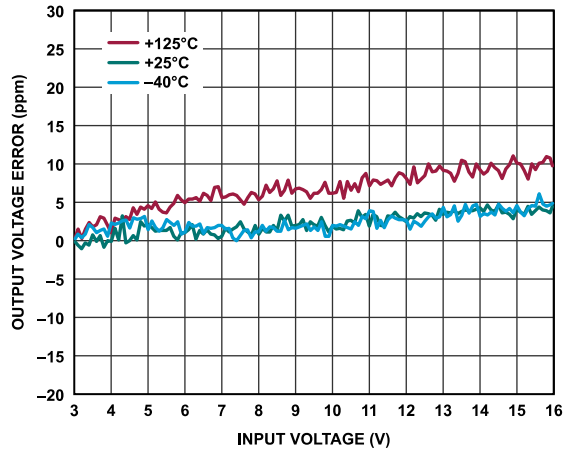

Figure 25. ADR3625 Output Voltage Error vs. Input Voltage

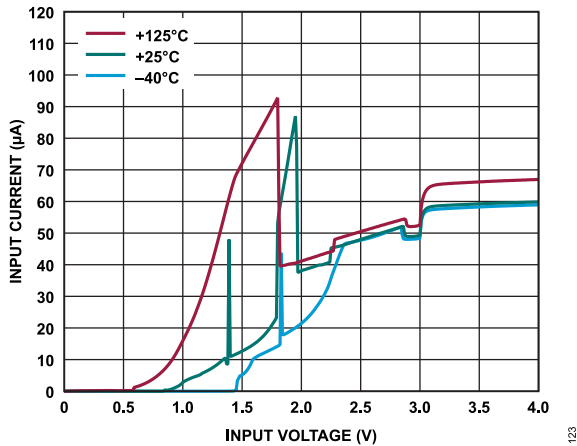

Figure 23. ADR3630 Input Current vs. Input Voltage

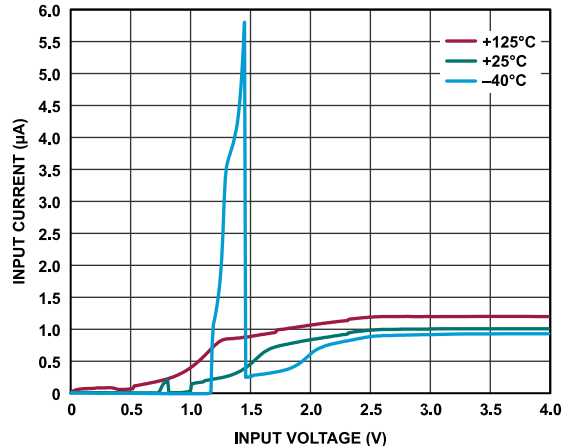

Figure 26. Input Current vs. Input Voltage (Shutdown)

TYPICAL PERFORMANCE CHARACTERISTICS

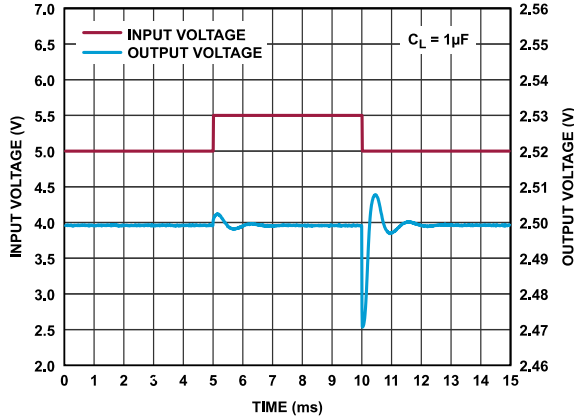

Figure 27. ADR3625 Line Transient Response

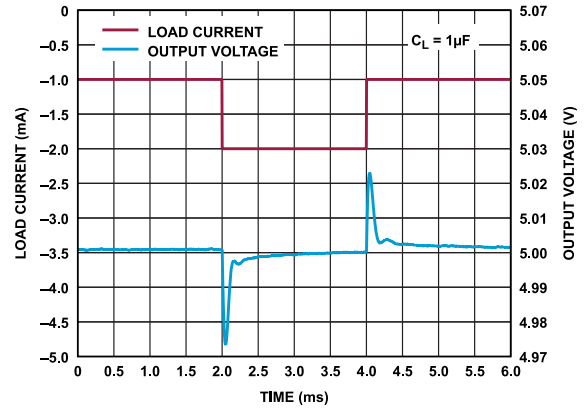

Figure 30. ADR3650 Load Transient Response (Source)

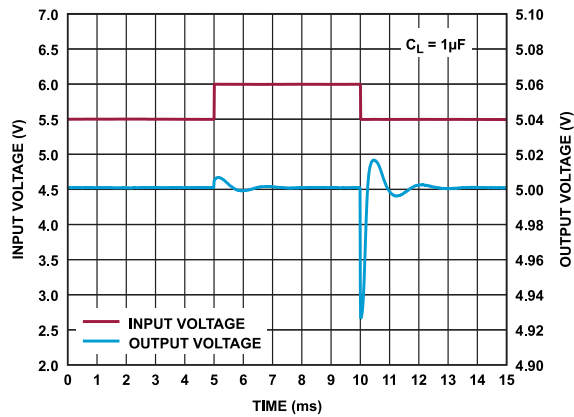

Figure 28. Line Transient Response

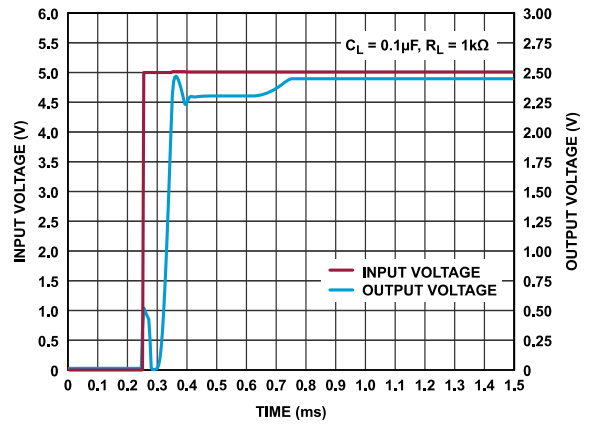

Figure 31. ADR3625 Start-Up Response (Input)

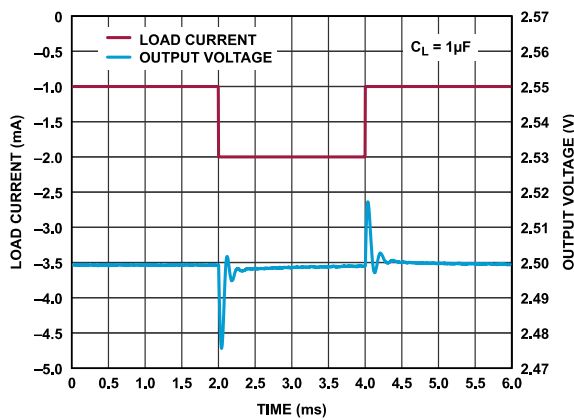

Figure 29. ADR3625 Load Transient Response (Source)

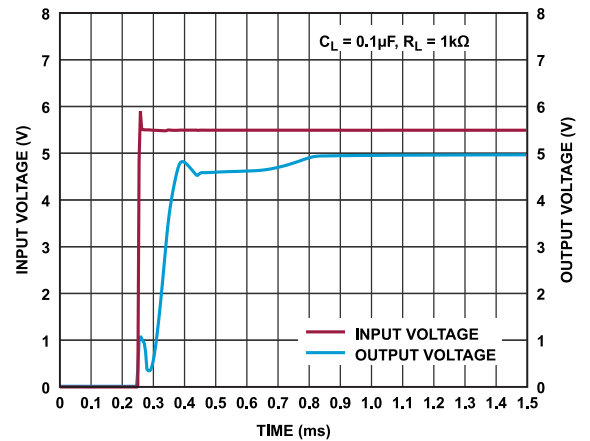

Figure 32. ADR3650 Start-Up Response (Input)

TYPICAL PERFORMANCE CHARACTERISTICS

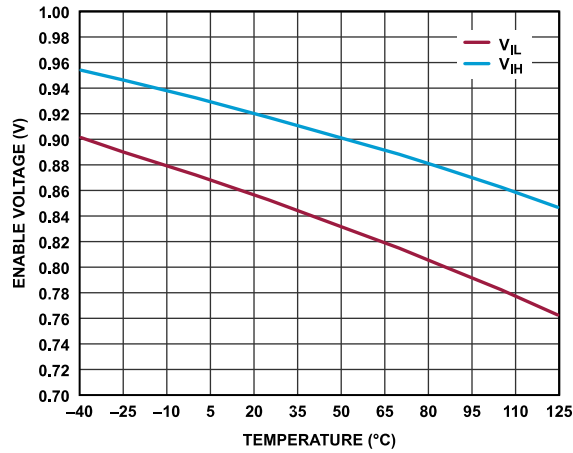

Figure 33. Enable Voltage vs. Temperature

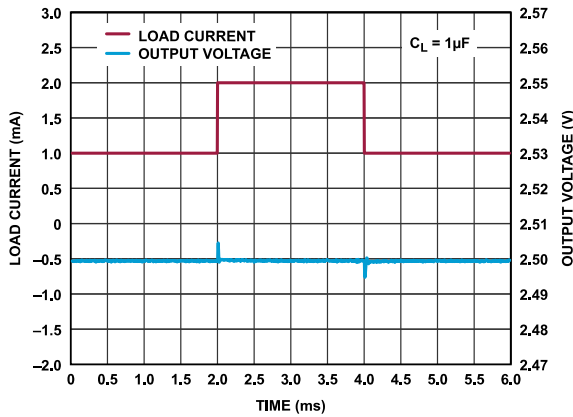

Figure 34. ADR3625 Load Transient Response (Sink)

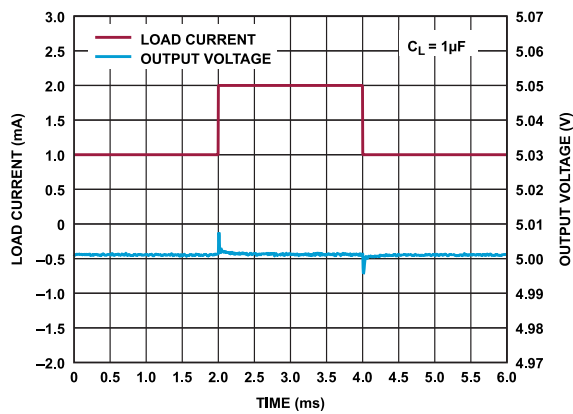

Figure 35. ADR3650 Load Transient Response (Sink)

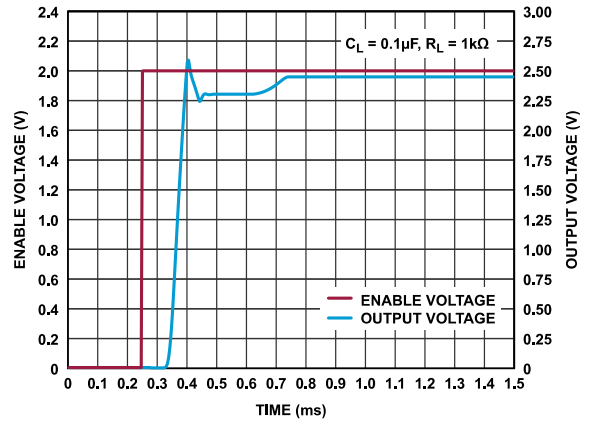

Figure 36. ADR3625 Start-Up Response (Enable)

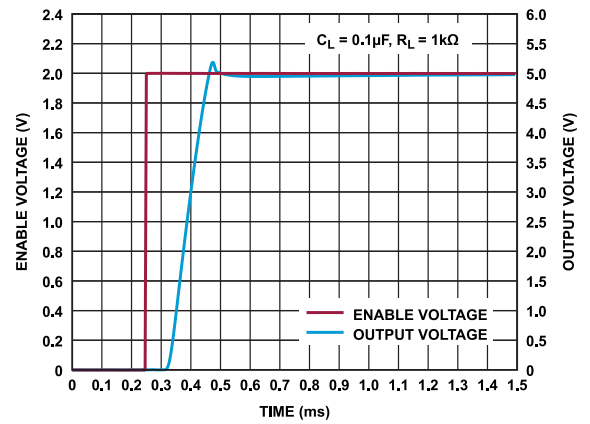

Figure 37. ADR3650 Start-Up Response (Enable)

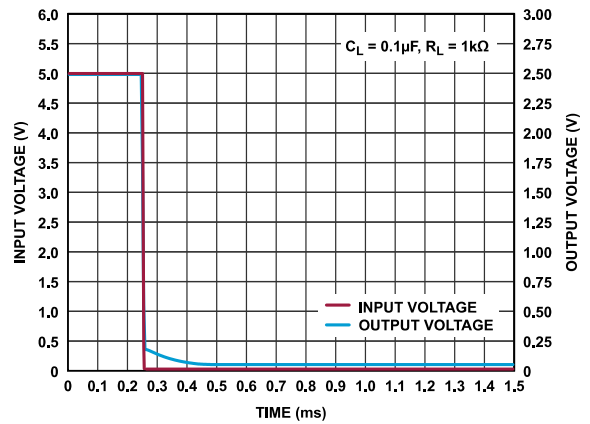

Figure 38. ADR3625 Shutdown Response (Input)

TYPICAL PERFORMANCE CHARACTERISTICS

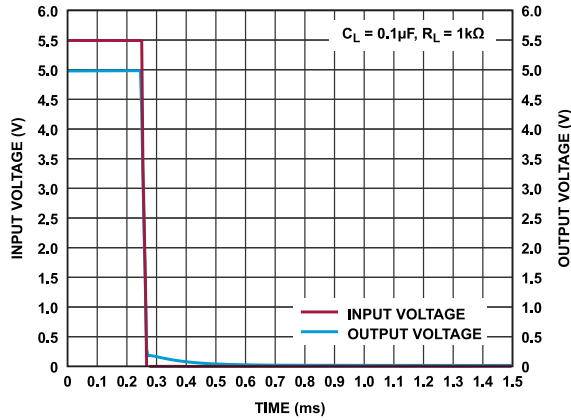

Figure 39. ADR3650 Shutdown Response (Input)

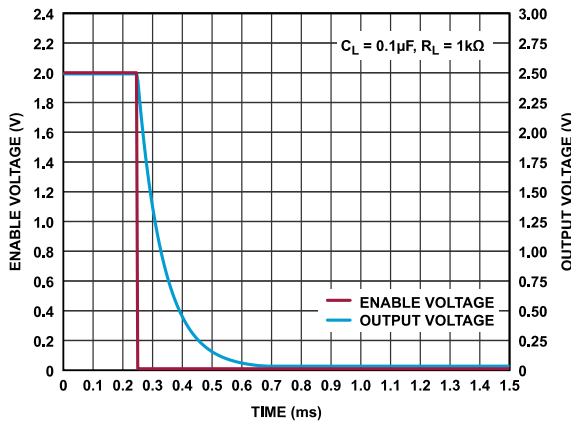

Figure 40. ADR3625 Shutdown Response (Enable)

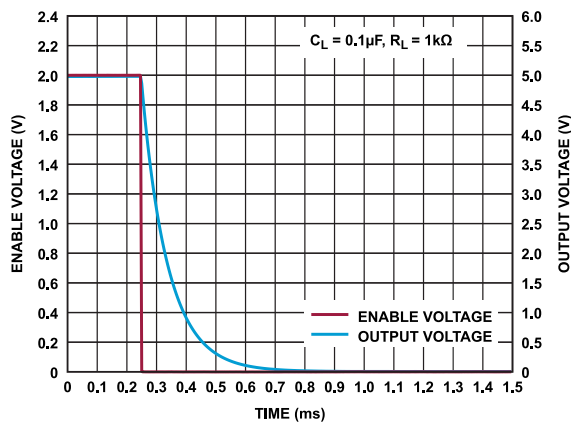

Figure 41. ADR3650 Shutdown Response (Enable)

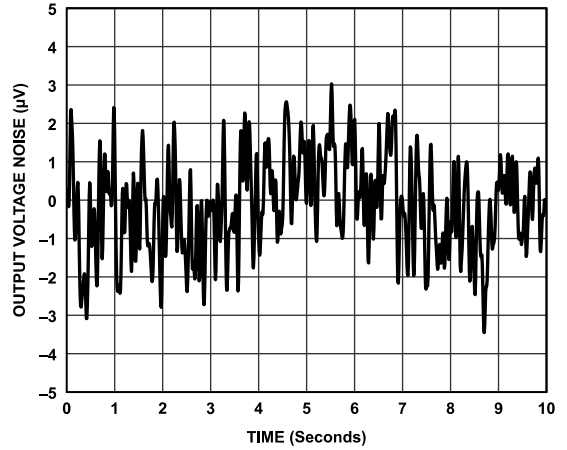

Figure 42. ADR3625 Voltage Noise (0.1 Hz to 10 Hz)

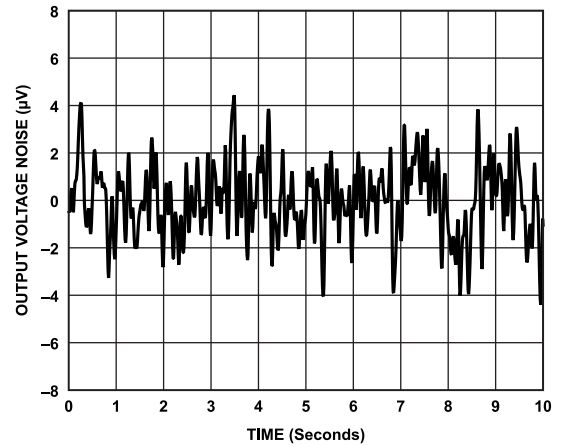

Figure 43. ADR3630 Voltage Noise (0.1 Hz to 10 Hz)

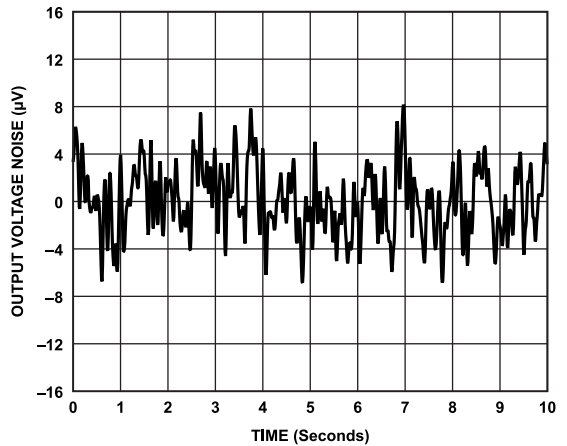

Figure 44. ADR3650 Voltage Noise (0.1 to 10 Hz)

TYPICAL PERFORMANCE CHARACTERISTICS

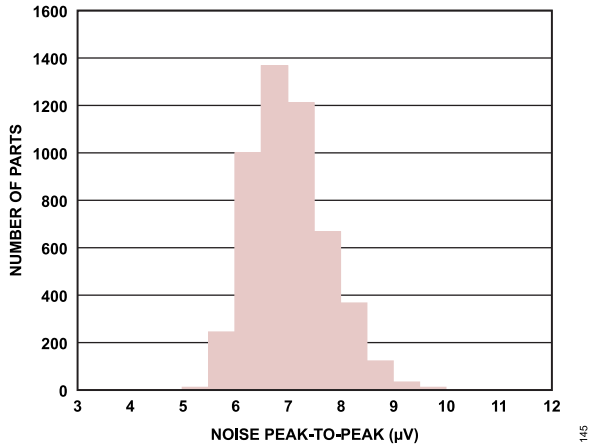

Figure 45. ADR3625 Voltage Noise (0.1 Hz to 10 Hz) Histogram

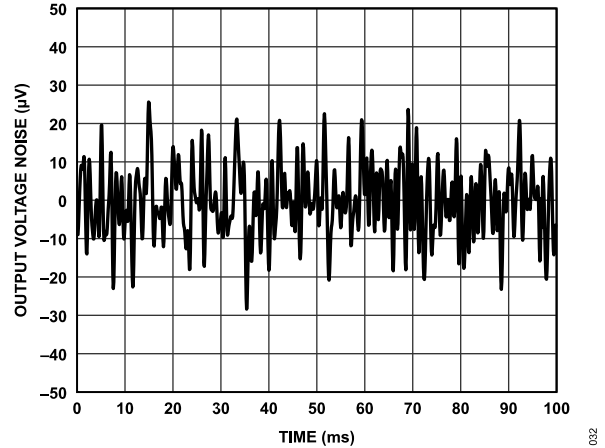

Figure 48. ADR3625 Output Voltage Noise (10 Hz to 1 kHz)

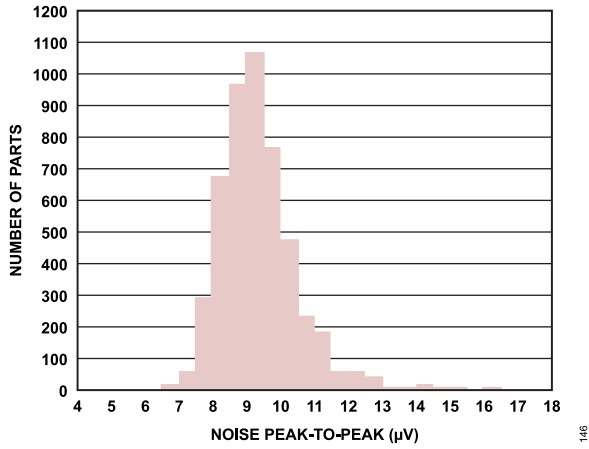

Figure 46. ADR3630 Voltage Noise (0.1 Hz to 10 Hz) Histogram

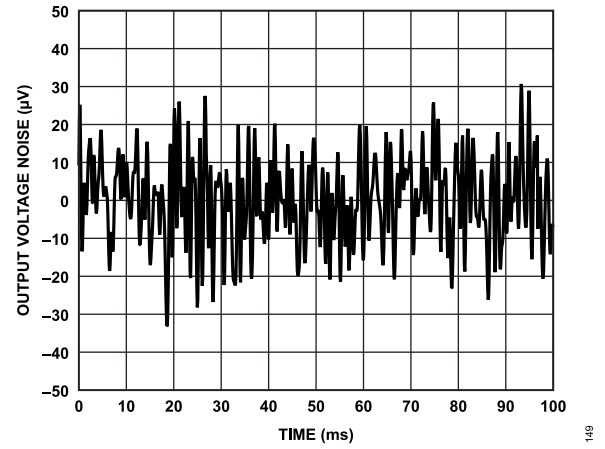

Figure 49. ADR3630 Output Voltage Noise (10 Hz to 1 kHz)

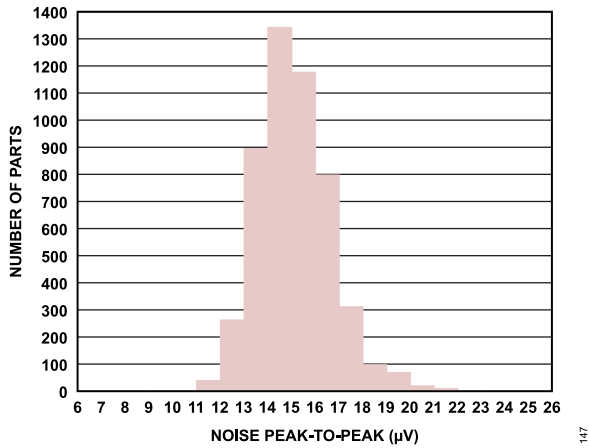

Figure 47. ADR3650 Voltage Noise (0.1 Hz to 10 Hz) Histogram

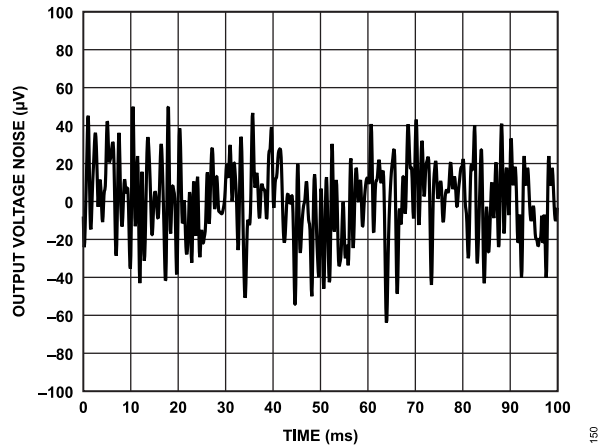

Figure 50. ADR3650 Output Voltage Noise (10 Hz to 1 kHz)

TYPICAL PERFORMANCE CHARACTERISTICS

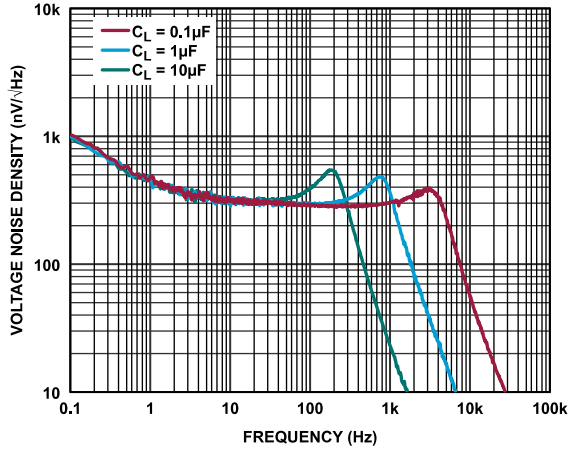

Figure 51. ADR3625 Voltage Noise Density

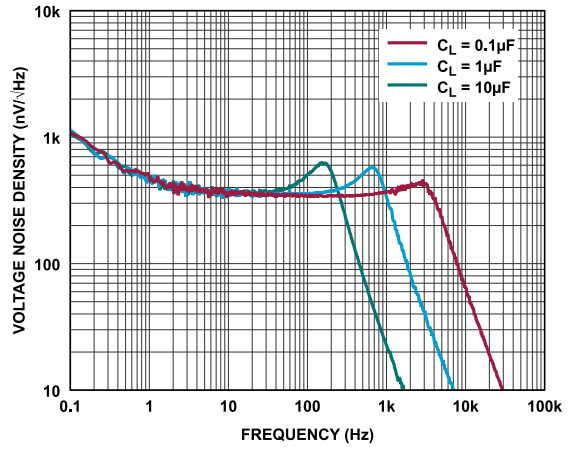

Figure 52. ADR3630 Voltage Noise Density

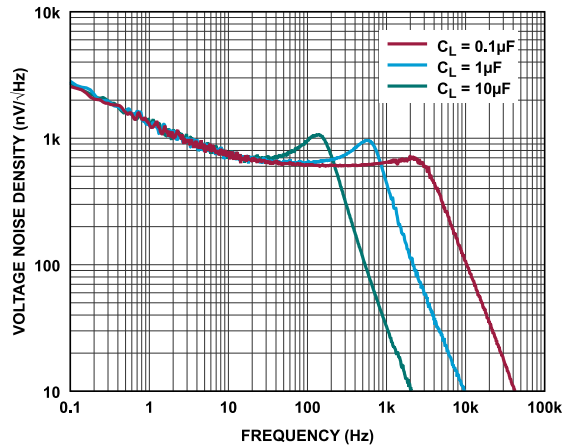

Figure 53. ADR3650 Voltage Noise Density

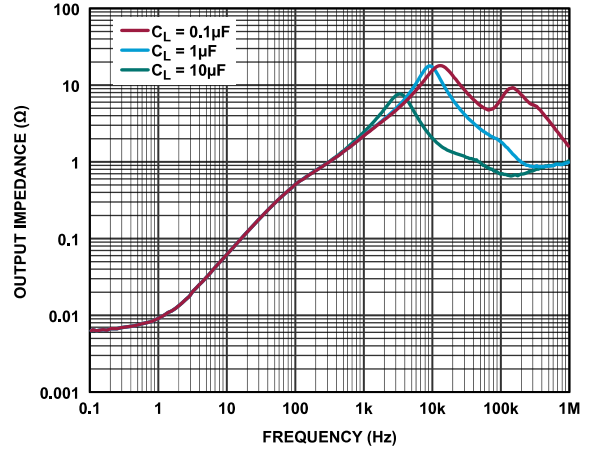

Figure 54. Output Impedance vs. Frequency

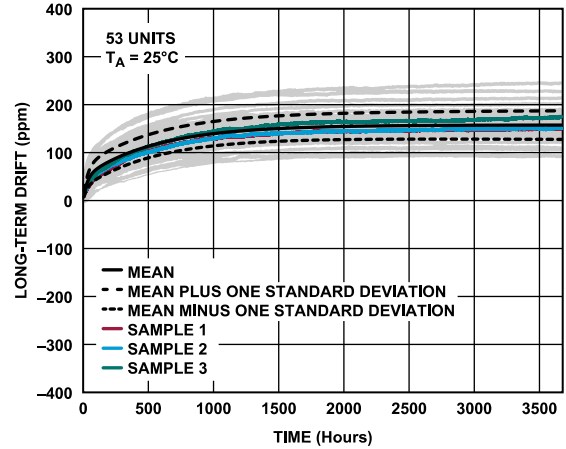

Figure 55. Long-Term Drift

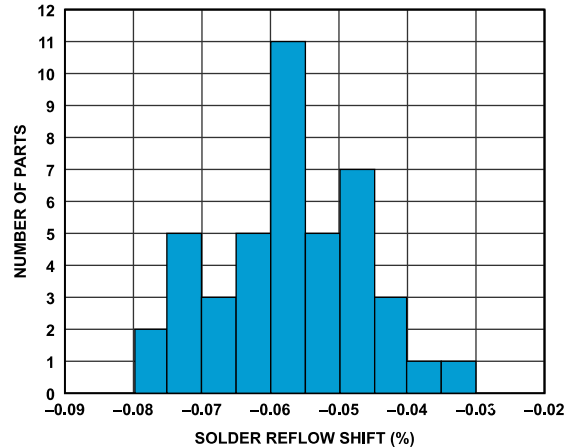

Figure 56. Solder Heat Reflow Shift Histogram

TYPICAL PERFORMANCE CHARACTERISTICS

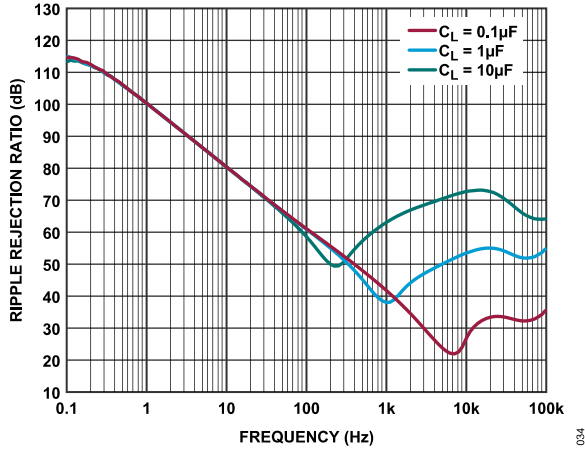

Figure 57. Ripple Rejection Ratio vs. Frequency

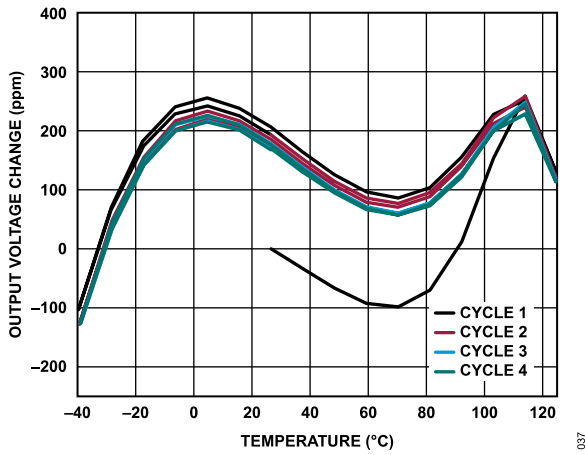

Figure 58. ADR3625 Hysteresis

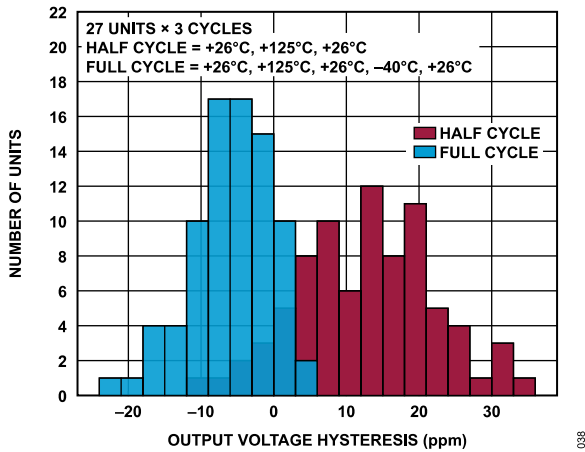

Figure 59. ADR3625 Hysteresis Histogram

TERMINOLOGY

Dropout Voltage

Dropout voltage (V_{DO}), sometimes referred to as supply voltage headroom or supply output voltage differential, is defined as the minimum voltage differential between the input and output such that the output voltage is maintained to within 0.1% accuracy.

$$V_{DO} = (V_{IN} - V_{OUT})_{MIN}$$

Because V_{DO} depends on the current passing through the device, it is always specified for a given load current. In series mode devices, the dropout voltage typically increases proportionally to the load current (see [Figure 8](#) and [Figure 9](#)).

Line Regulation

Line regulation refers to the change in output voltage in response to a given change in input voltage and is expressed in percent per volt, ppm per volt, or μV per volt change in input voltage.

Load Regulation

Load regulation refers to the change in output voltage in response to a given change in load current and is expressed in μV per mA, ppm per mA, or Ω of dc output resistance.

Solder Heat Resistance Shift

Solder heat resistance shift refers to the permanent shift in output voltage that is induced by exposure to reflow soldering and is expressed as a percentage of the output voltage. This shift is caused by changes in the stress exhibited on the die by the package materials when these materials are exposed to high temperatures. This effect is more pronounced in lead-free soldering processes due to higher reflow temperatures. Solder heat resistance is calculated after three solder reflow cycles to simulate the worst case conditions when assembling a two-sided PCB with surface-mount components with one additional rework cycle. The reflow cycles use the JEDEC standard reflow temperature profile.

Temperature Coefficient

The temperature coefficient (TCV_{OUT}) relates the change in the output voltage to the change in the ambient temperature of the device, as normalized by the output voltage at 25°C. The TCV_{OUT} for the ADR3625\ADR3630\ADR3650 is fully tested over three temperatures: -40°C, +25°C, and +125°C.

Box Method

The box method is represented by the following equation:

$$TCV_{OUT} = \left| \frac{\max(V_{OUT}(T_1, T_2, T_3)) - \min(V_{OUT}(T_1, T_2, T_3))}{V_{OUT}(T_2) \times (T_3 - T_1)} \right| \times 10^6$$

where:

TCV_{OUT} is expressed in ppm/°C.

$V_{OUT}(T_x)$ is the output voltage at temperature T_x .

$T_1 = -40^\circ\text{C}$.

$T_2 = +25^\circ\text{C}$.

$T_3 = +125^\circ\text{C}$.

This box method ensures that TCV_{OUT} accurately portrays the maximum difference between any of the three temperatures at which the output voltage of the device is measured.

Thermal Hysteresis

Thermal hysteresis (ΔV_{OUT_HYS}) represents the change in the output voltage after the device is exposed to a specified temperature cycle. ΔV_{OUT_HYS} is expressed as a difference in ppm from the nominal output.

$$\Delta V_{OUT_HYS} = \frac{V_{OUT1_25^\circ\text{C}} - V_{OUT2_25^\circ\text{C}}}{V_{OUT1_25^\circ\text{C}}} \times 10^6 (\text{ppm})$$

where:

$V_{OUT1_25^\circ\text{C}}$ is the output voltage at 25°C.

$V_{OUT2_25^\circ\text{C}}$ is the output voltage after temperature cycling.

Long-Term Drift

Long-term drift (ΔV_{OUT_LTD}) refers to the shift in the output voltage vs. time. This is expressed as a difference in ppm from the nominal output.

$$\Delta V_{OUT_LTD} = \left| \frac{V_{OUT}(t_1) - V_{OUT}(t_0)}{V_{OUT}(t_0)} \right| \times 10^6 (\text{ppm})$$

where:

$V_{OUT}(t_0)$ is the V_{OUT} at the starting time of the measurement.

$V_{OUT}(t_1)$ is the V_{OUT} at the end time of the measurement.

THEORY OF OPERATION

The ADR3625\ADR3630\ADR3650 incorporate a proprietary, low-noise design and advanced, curvature correction technology. Combined with micropower design techniques, the ADR3625\ADR3630\ADR3650 have unmatched performance.

The circuit shown in Figure 60 shows the ADR3625\ADR3630\ADR3650 simplified schematic.

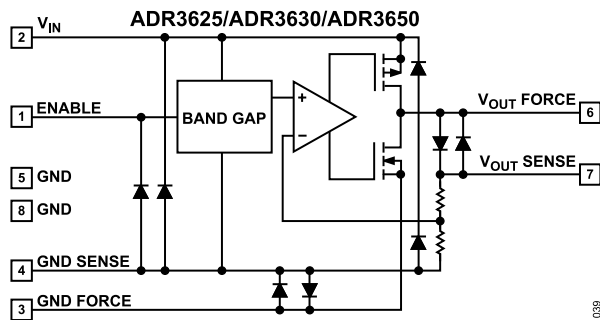

Figure 60. Simplified Schematic

POWER DISSIPATION

While the ADR3625\ADR3630\ADR3650 are a micropower voltage reference, these devices are capable of sourcing 50 mA and sinking current up to 10 mA of load current at room temperature across the rated input voltage range. However, when used in applications subject to high ambient temperatures, the input voltage and load current must be monitored carefully to ensure that the devices do not exceed their maximum allowable power dissipation. To calculate the maximum allowable power dissipation of these devices, use the following equation:

$$P_D = \frac{T_J - T_A}{\theta_{JA}}$$

where:

P_D is the power dissipation of the devices.

T_J is the junction temperature of the devices.

T_A is the ambient temperature of the devices.

The ADR3625\ADR3630\ADR3650 have a thermal resistance of 132.5°C/W for the 8-lead MSOP. A curve that illustrates the allowed power dissipation vs. temperature for the MSOP is shown in Figure 61. The power dissipation of the ADR3625 as a function of the input voltage is shown in Figure 62. The top curve shows power dissipation with a 50 mA load, and the bottom curve shows power dissipation with no load. When operated within its specified limits of $V_{IN} = 16$ V and sourcing is 50 mA, the ADR3625 consumes about 800 mW at room temperature. The power derating curve in Figure 61 shows that the ADR3625\ADR3630\ADR3650 can only safely dissipate 120 mW at 125°C, which is less than its maximum power output. Care must be taken when designing the circuit so that the maximum junction temperature is not exceeded. For best performance, keep the junction temperature less than 150°C.

The ADR3625\ADR3630\ADR3650 includes output current-limit circuitry, as well as thermal limit circuitry, to protect the reference

from damage in the event of excessive power dissipation. The ADR3625\ADR3630\ADR3650 is protected from damage by a thermal shutdown circuit. However, changes in performance can occur as a result of operating at above the maximum rating.

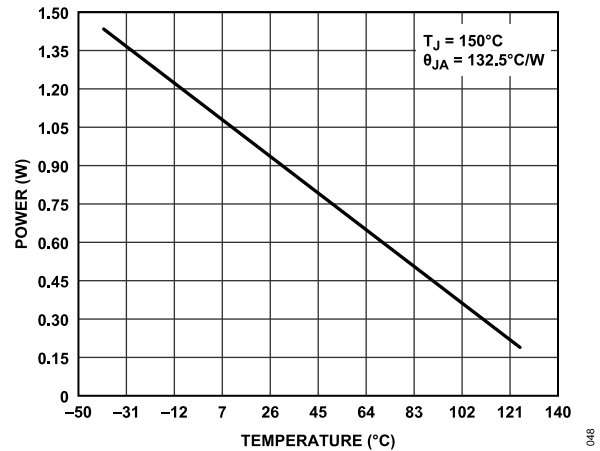

Figure 61. Maximum Allowed Power Dissipation

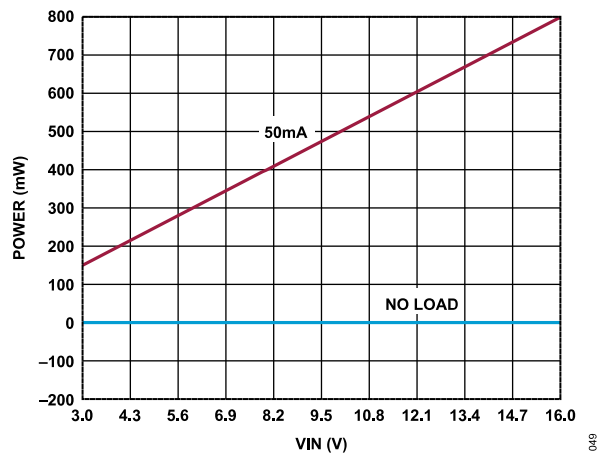

Figure 62. ADR3625 Typical Power Dissipation

INTERNAL PROTECTION

The ADR3625\ADR3630\ADR3650 have two internal protection circuits for monitoring the output current and internal junction temperature.

The ADR3625\ADR3630\ADR3650 have a current-limit circuit that limits the output source current in the event of a short circuit from the V_{OUT} FORCE pin to ground. The limit is set to 90 mA (typical) and does not vary much over temperature or input voltage.

An overtemperature shutdown circuit disables the output source current when the internal junction temperature reaches 178°C. There is 3°C of hysteresis. Once the junction temperature reduces to less than the hysteresis, the output drive circuit re-enables. Degradation can occur or reliability can be affected when the junction temperature of the devices exceeds 150°C.

THEORY OF OPERATION

LONG-TERM DRIFT

The stability of a precision signal path over its lifetime, or between calibration procedures, is dependent on the long-term stability of the analog components in its path, such as op amps, references, and data converters. To help system designers predict the long-term drift of the circuits that use the ADR3625\ADR3630\ADR3650, Analog Devices measured the output voltage of multiple units for more than 3500 hours using a high precision measurement system, including an ultrastable oil bath. To replicate the real-world system performance, the devices under test (DUTs) were soldered onto an FR4 PCB using a standard reflow profile (as defined in the JEDEC J-STD-020D standard), rather than testing them in sockets. This manner of testing is important because expansion and contraction of the PCB can apply stress to the IC package and contribute to shifts in the offset voltage.

Note that early life drift (0 hours to 250 hours) accounts for 50% of the total drift observed over 3500 hours, as shown in Figure 63. The first 1000 hours account for the 80% of the total drift, and the remaining 2500 hours account for the remaining 20% of the drift. Thus, the early life drift is the dominant contributor, whereas the drift after 1000 hours is significantly lower.

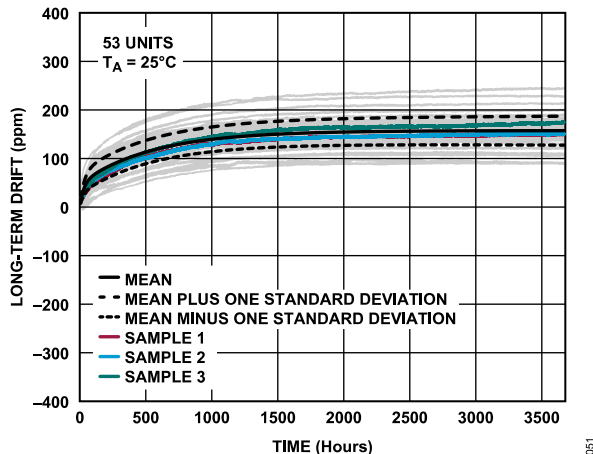

Figure 63. Long-Term Drift

THERMAL HYSTERESIS

In addition to stability over time, as described in the Long-Term Drift section, it is useful to know the thermal hysteresis, that is, the stability vs. cycling of temperature. Thermal hysteresis is an important parameter because it tells the system designer how closely the signal returns to its starting amplitude after the ambient temperature changes and the subsequent return to room temperature. Figure 64 shows the change in output voltage as the temperature cycles four times from room temperature to +125°C to -40°C and back to room temperature.

Other than the first full cycle, the output hysteresis is typically -7 ppm. The histogram in Figure 65 shows that the hysteresis is larger when the device cycles through only a half cycle, from

room temperature to 125°C and back to room temperature, typically 15 ppm.

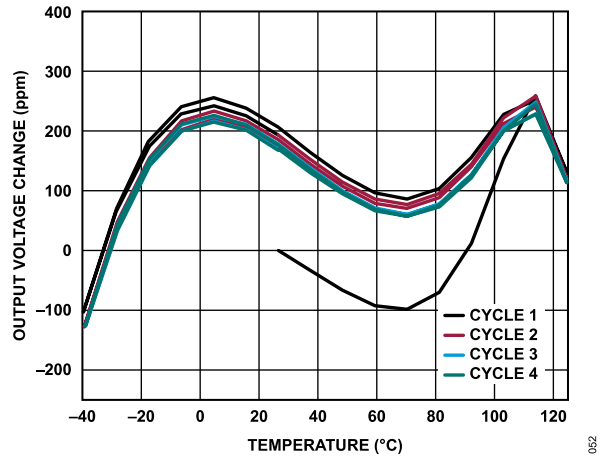

Figure 64. Change in Output Voltage over Four Full Temperature Cycle

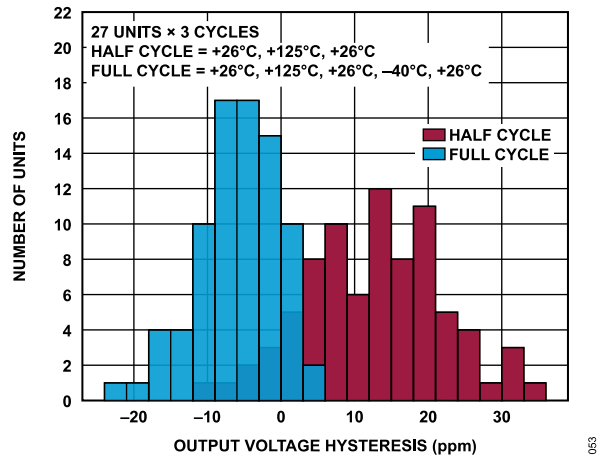

Figure 65. Output Voltage Hysteresis Histogram (-40°C to +125°C)

POWER CYCLE HYSTERESIS

By power cycling large numbers of samples, the power cycle hysteresis can be determined. To keep this measurement independent of other variables and environmental effects, the power cycle testing was performed using a high precision measurement system, including an ultrastable oil bath.

Figure 66 shows the power cycle hysteresis. The units were powered down for approximately four hours and then powered up. The ADR3625\ADR3630\ADR3650 do not have any power cycle hysteresis even after a long power-down period, making these devices suitable for equipment that must maintain calibration accuracy between power cycles.

THEORY OF OPERATION

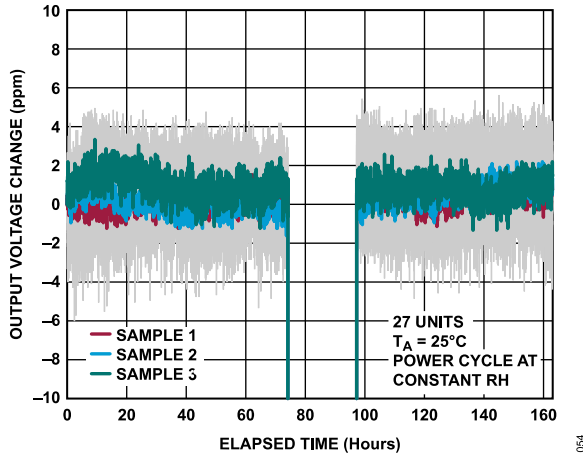

Figure 66. Power Cycle Hysteresis

HUMIDITY SENSITIVITY

The ADR3625\ADR3630\ADR3650 are packaged in an MSOP. However, moisture absorption from the air into the package changes the internal mechanical stresses on the die, causing shifts in the output voltage. Figure 67 shows the effects of a step change in relative humidity on the output voltage over time. The humidity chamber is maintained at an ambient temperature of 25°C, while the relative humidity undergoes a step change from 30% to 70%. The relative humidity is maintained at 70% for the duration of the testing. Note that the output voltage shifts quickly compared to the overall settling time, following the step change in relative humidity.

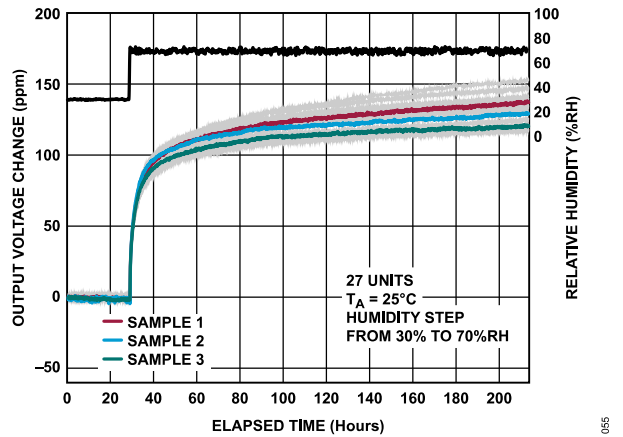

Figure 67. Change in Output Voltage vs. Time After Humidity Step (30% to 70% Relative Humidity (RH))

APPLICATIONS INFORMATION

BASIC VOLTAGE REFERENCE CONNECTION

The basic configuration for the ADR3625\ADR3630\ADR3650 reference is shown in Figure 68. For detailed information on connecting the bypass capacitors, see the [Input and Output Capacitors](#) section.

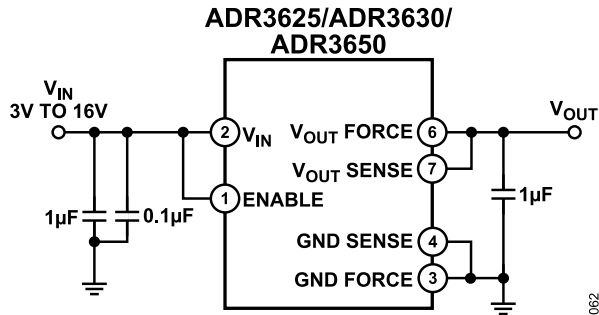

Figure 68. Basic Reference Connection

INPUT AND OUTPUT CAPACITORS

Input Capacitors

A 1 μF to 10 μF electrolytic or ceramic capacitor can be connected to the input to improve transient response in applications where the supply voltage can fluctuate. It is recommended to connect an additional 0.1 μF ceramic capacitor in parallel to reduce supply noise.

Output Capacitors

A C_{OUT} is required for stability and to filter out low level voltage noise. The minimum value of C_{OUT} is 0.1 μF and can go as high as 10 μF for stability.

An additional 1 μF to 10 μF electrolytic or ceramic capacitor can be added in parallel to improve transient performance in response to sudden changes in load current.

The larger the output capacitor, the lower the bandwidth of the output is, thus lowering the noise. However, increasing the output capacitor increases the settling time and decreases the response rate.

The ADR3625\ADR3630\ADR3650 are stable with a variety of capacitor types, including ceramic, electrolytic (including polymer), tantalum, and film. Small surface-mount capacitors have low effective series resistance (ESR) and take up little board space. Place and connect the output capacitor as close as possible to the V_{OUT} FORCE pin. Use low ESR capacitors.

START-UP TIME

The start-up time is determined by the output capacitance and output load current. Figure 69 shows an example of the start-up response of the ADR3625 when stepping the supply voltage and Figure 70 shows an example of the start-up response of the ADR3625 when stepping the enable voltage.

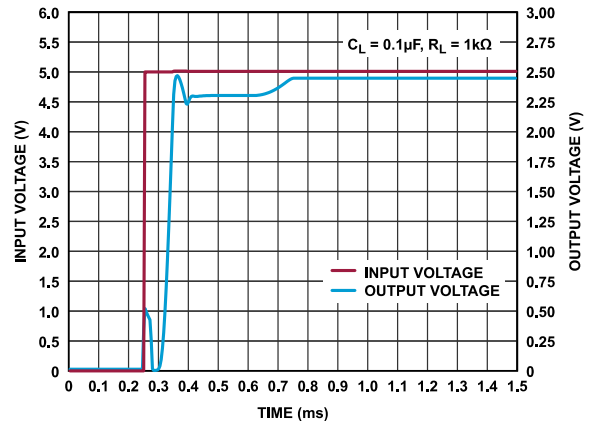

Figure 69. ADR3625 Start-Up Response (Input)

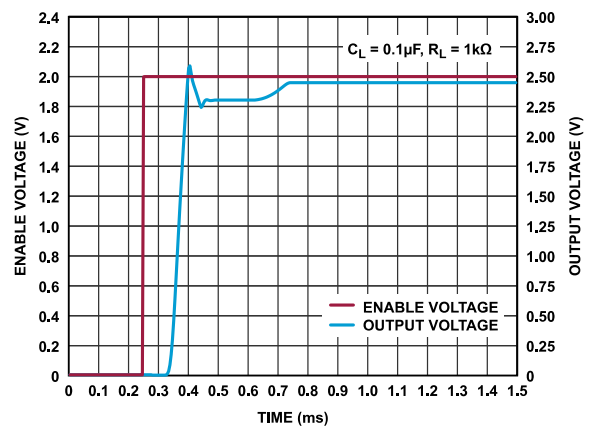

Figure 70. ADR3625 Start-Up Response (Enable)

APPLICATIONS INFORMATION

SETTLING TIME

The ADR3625\ADR3630\ADR3650 can take up to 16 V supply, source 50 mA, and sink 10 mA. The output settling time is dependent upon the output capacitance and load current. Figure 71 through Figure 74 show the transient response of the ADR3625 example at different conditions.

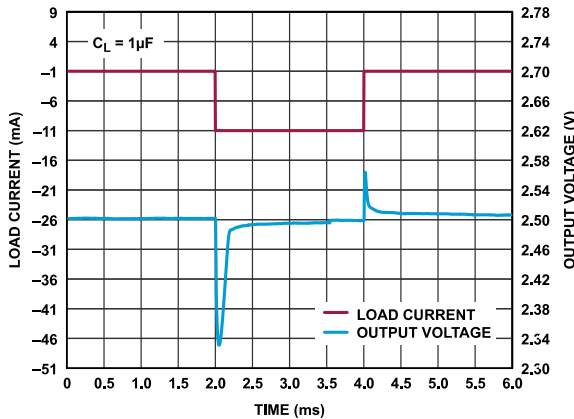

Figure 71. ADR3625 10 mA Sourcing Response

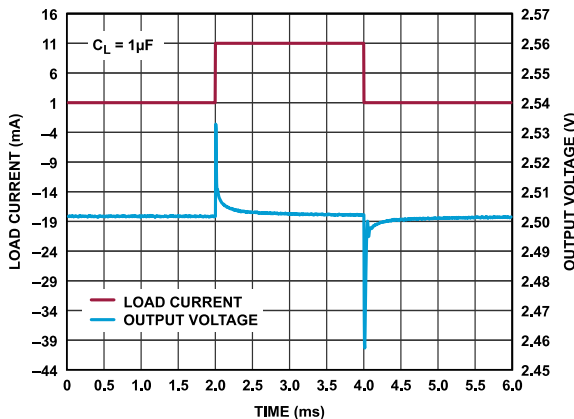

Figure 72. ADR3625 10 mA Sinking Response

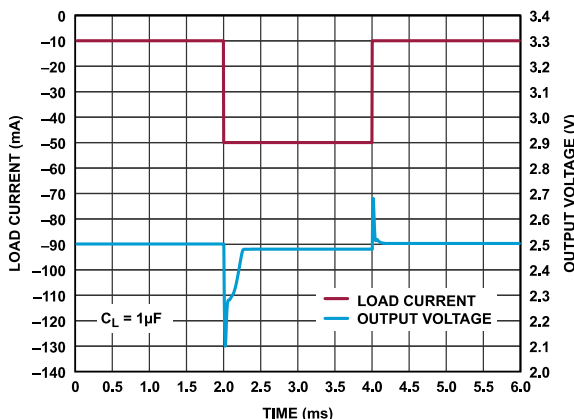

Figure 73. ADR3625 50 mA Sourcing Response

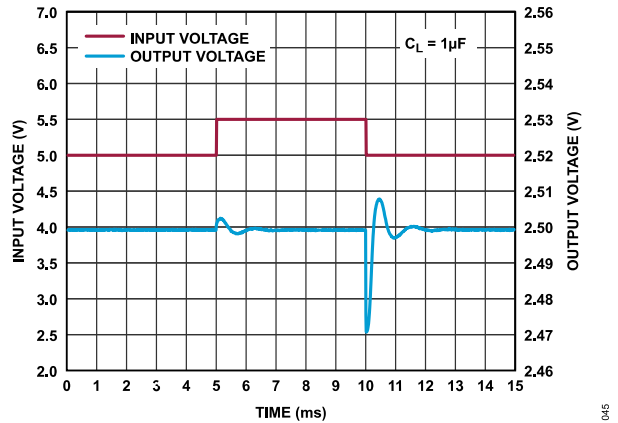

Figure 74. ADR3625 Output Response with a 500 mV Step on V_{IN}

ENABLE PIN

The ENABLE pin is compatible with 1.8 V thresholds and has an internal active pull-up. When powered down, the supply current is only 1.5 μA typical.

There is no diode connected between the ENABLE pin and V_{IN}. The ENABLE pin can be driven high when V_{IN} is low without drawing current or powering the device through the ENABLE pin as can happen with other references.

PCB LAYOUT

The mechanical stress of soldering a surface-mount voltage reference to a PCB can cause the output voltage to shift and the temperature coefficient to change. These two changes are not correlated. For example, the voltage may shift but the temperature coefficient may not.

To reduce the effects of the stress-related shifts, mount the reference near the short edge of the PCB or in a corner. In addition, slots can be cut into the PCB on two sides of the device. For more information, see Application Note AN82.

Connect the output capacitor close to the V_{OUT} FORCE pin. For good load regulation, connect the V_{OUT} SENSE pin directly at the load, as shown in Figure 75.

APPLICATIONS INFORMATION

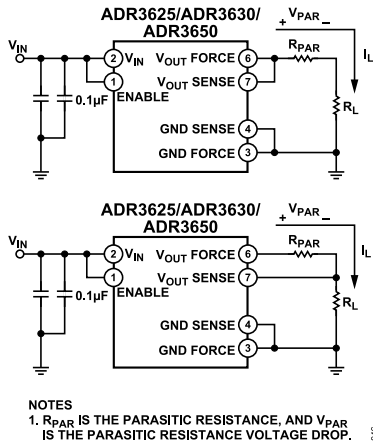

Figure 75. Output Force and Sense

Avoid adding parasitic resistance between the load and the V_{OUT} SENSE pin. Minimize the metal parasitic in the V_{OUT} FORCE line to the load to maintain a low dropout voltage.

The GND_FORCE line carries the load sinking current. Connect the GND_FORCE line directly to the bottom of the load as shown in Figure 76.

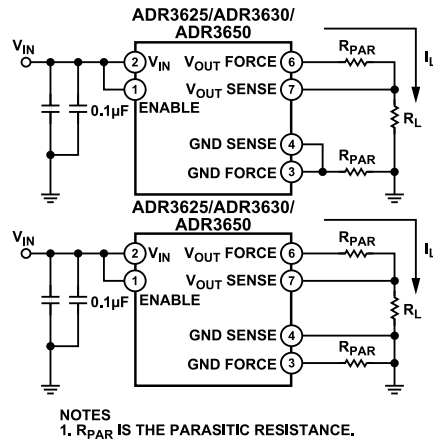
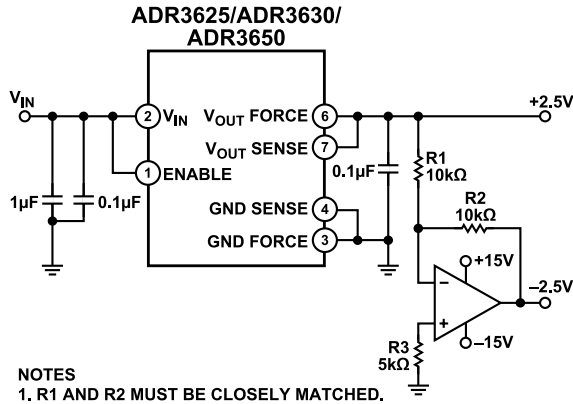

Figure 76. Ground Force and Sense

SAMPLE APPLICATIONS

The ADR3625\ADR3630\ADR3650 can be used in various applications, some of which are shown as follows.



NOTES
1. R1 AND R2 MUST BE CLOSELY MATCHED.

056

Figure 77. Bipolar Output Reference

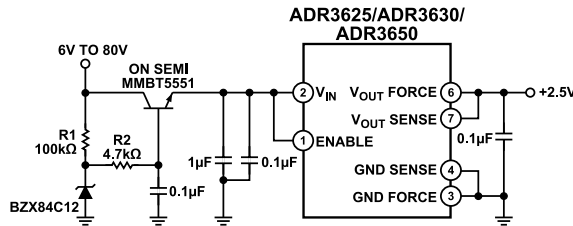
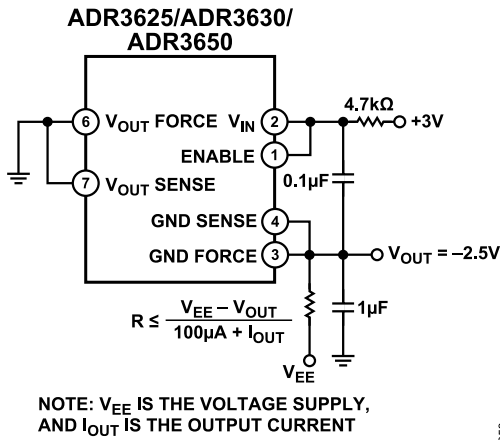

Figure 78. Extended Supply Range

060



NOTE: V_{EE} IS THE VOLTAGE SUPPLY, AND I_{OUT} IS THE OUTPUT CURRENT

058

Figure 79. Negative Voltage Output

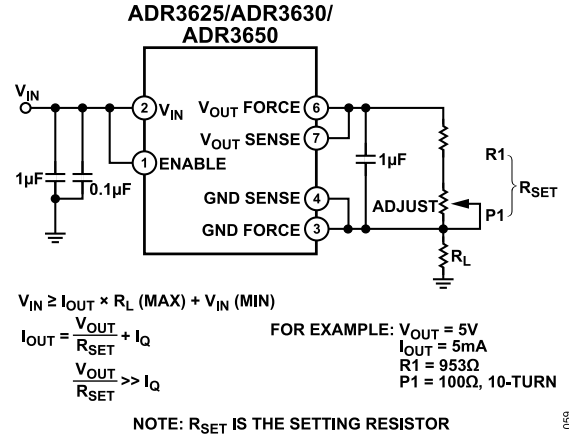

$$V_{IN} \geq I_{OUT} \times R_L (MAX) + V_{IN} (MIN)$$

$$I_{OUT} = \frac{V_{OUT}}{R_{SET}} + I_Q$$

$$\frac{V_{OUT}}{R_{SET}} \gg I_Q$$

FOR EXAMPLE: V_{OUT} = 5V
I_{OUT} = 5mA
R1 = 953Ω
P1 = 100Ω, 10-TURN

NOTE: R_{SET} IS THE SETTING RESISTOR

059

Figure 80. Constant Current

OUTLINE DIMENSIONS

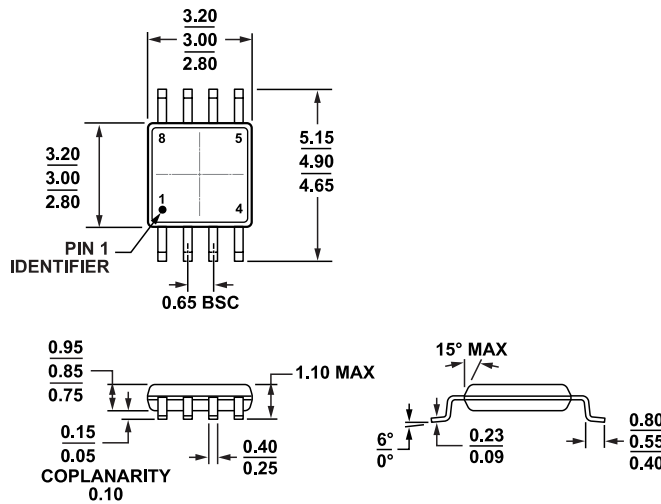

COMPLIANT TO JEDEC STANDARDS MO-187-AA

Figure 81. 8-Lead Mini Small Outline Package [MSOP] (RM-8)
Dimensions shown in millimeters

10-07-2009-B

Updated: January 06, 2023

ORDERING GUIDE

Model ¹	Temperature Range	Package Description	Packing Quantity	Package Option	Marking Code
ADR3625ARMZ	-40°C to +125°C	8-Lead MSOP	Tube, 50	RM-8	FJ
ADR3625ARMZ-R7	-40°C to +125°C	8-Lead MSOP	Reel, 1000	RM-8	FJ
ADR3625BRMZ	-40°C to +125°C	8-Lead MSOP	Tube, 50	RM-8	FK
ADR3625BRMZ-R7	-40°C to +125°C	8-Lead MSOP	Reel, 1000	RM-8	FK
ADR3630ARMZ	-40°C to +125°C	8-Lead MSOP	Tube, 50	RM-8	GE
ADR3630ARMZ-R7	-40°C to +125°C	8-Lead MSOP	Reel, 1000	RM-8	GE
ADR3630BRMZ	-40°C to +125°C	8-Lead MSOP	Tube, 50	RM-8	GG
ADR3630BRMZ-R7	-40°C to +125°C	8-Lead MSOP	Reel, 1000	RM-8	GG
ADR3650ARMZ	-40°C to +125°C	8-Lead MSOP	Tube, 50	RM-8	G8
ADR3650ARMZ-R7	-40°C to +125°C	8-Lead MSOP	Reel, 1000	RM-8	G8
ADR3650BRMZ	-40°C to +125°C	8-Lead MSOP	Tube, 50	RM-8	G9
ADR3650BRMZ-R7	-40°C to +125°C	8-Lead MSOP	Reel, 1000	RM-8	G9

¹ Z = RoHS Compliant Part.

EVALUATION BOARDS

Table 7. Evaluation Boards

Model ¹	Description
EVAL-ADR3625EBZ	ADR3625 Evaluation Board
EVAL-ADR3630EBZ	ADR3630 Evaluation Board
EVAL-ADR3650EBZ	ADR3650 Evaluation Board

¹ Z = RoHS-Compliant Part.