



FEATURES

100W Full Bridge Topology (adjustable to full bridge phase shifted topology)
Advanced Voltage Mode Control with Integrated Volt-Second Balance
I2C Serial Interface to PC
Software GUI
Programmable Digital Filters
7 PWM Outputs Including Auxiliary PWM
Digital Trimming
OrFET Control for Hot Swap and Redundancy
Current, Voltage, and Temperature Sense through GUI
Calibration and Trimming
Analog/Digital Current Sharing
Line Voltage Feed Forward

CAUTION

This evaluation board uses high voltages and currents. Extreme caution must be taken especially on the primary side, to ensure safety for the user. It is strongly advised to power down the evaluation board when not in use. A current limited power supply is recommended as the input has no fuse present on the board.

ADP1046A EVALUATION BOARD OVERVIEW

This evaluation board features the ADP1046A in a switching power supply application. With the evaluation board and software, the ADP1046A can be interfaced with any PC running Windows 2000/XP/Vista/NT/7 via the computer's USB port. The software allows control and monitoring of the ADP1046A internal registers. The board is set up for the ADP1046A to act as an isolated switching power supply with a rated load of 12V/8A from an input voltage ranging from a 36 to 60VDC.

EVALUATION SYSTEM CONTENTS

The evaluation system package contains the following items:

- One ADP1046A evaluation board and one daughter card.

The USB/I2C dongle for serial communication and software CD needs to be ordered separately.
Order code: ADP-I2C-USB-Z

Rev. 1.3

Reference designs are as supplied "as is" and without warranties of any kind, express, implied, or statutory including, but not limited to, any implied warranty of merchantability or fitness for a particular purpose. No license is granted by implication or otherwise under any patents or other intellectual property by application or use of reference designs. Information furnished by Analog Devices is believed to be accurate and reliable. However, no responsibility is assumed by Analog Devices for its use, nor for any infringements of patents or other rights of third parties that may result from its use. Analog Devices reserves the right to change devices or specifications at any time without notice. Trademarks and registered trademarks are the property of their respective owners. Reference designs are not authorized to be used in life support devices or systems.

TABLE OF CONTENTS

Features	1
Caution	1
ADP1046A Evaluation Board Overview.....	1
Evaluation System Contents	1
Topology and Circuit Description.....	4
Connectors.....	4
Setting Files and EEPROM	6
Board Evaluation.....	7
Equipment	7
Setup	8
ADP1046A Programming Software.....	10
Flags Settings Configurations.....	11
General Settings and Softstart	12
PWM AND SR Settings	15
CS1 OR Input Current Setting.....	16
CS2 OR Output Current Setting	20
Light Load Mode.....	22
Output Voltage Settings.....	24
Digital Filter Settings and Transient Analysis.....	27
OrFET Settings.....	31
Full Bridge Phase Shifted Mode.....	35
Line Voltage Feedforward	37
Appendix I – Schematic (Main Board).....	39
Appendix II – Schematic (Daughter Card).....	40
Appendix III – Layout (Main Board).....	41
Appendix IV – Layout (Daughter Card)	44
Appendix V - Transformer Specification	47
Appendix VI - Output Inductor Specification	49
Appendix VII - Thermal Performance	50
Appendix VII - Thermal Performance	50
Appendix VIII – Efficiency and Voltage Regulation.....	52
Notes.....	55

REVISION HISTORY

10/03/2011—Revision 1.0: NSD
07/15/2012—Revision 2.0: SPM
08/03/2012—Revision 2.1: SPM

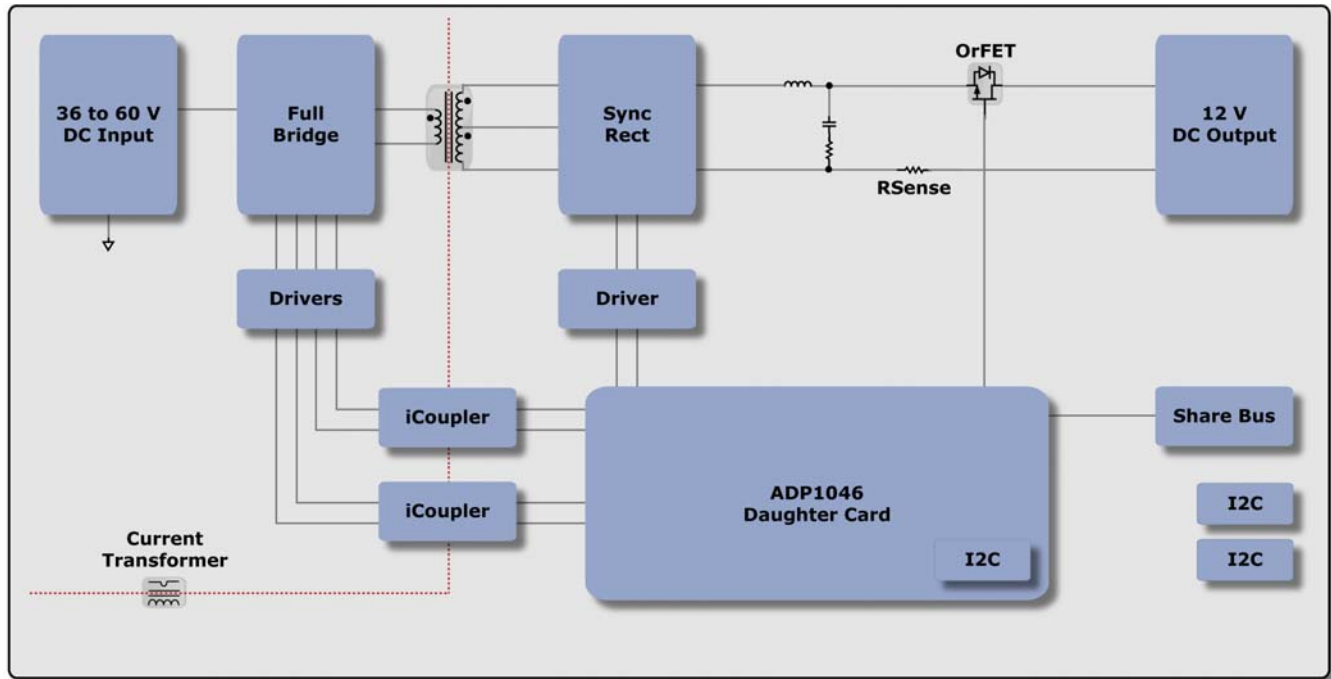


Figure 1 - Simplified block diagram

DEMO BOARD SPECIFICATIONS

Specification	MIN	TYP	MAX	Units	Notes
V_{IN}	36	48	60	V	
V_{OUT}		12		V	
I_{OUT}	0.0	8.0	10	A	
$T_{AMBIENT}$	0	30	65	°C	
Efficiency		89		%	Typical reading at 48V/8A load
Switching frequency	80	100.8	200	KHz	
Output Voltage Ripple			128	mV	At 48V input, 8A load

Table 1 - Target specifications

TOPOLOGY AND CIRCUIT DESCRIPTION

This evaluation board features the ADP1046A in a DC/DC switching power supply in full bridge topology with synchronous rectification. Figure 1 shows a block diagram of the main components on the board. The circuit is designed to provide a rated load of 12V/8A from an input voltage source of 36 to 60VDC. The ADP1046A provides functions such as output voltage regulation, over current protection, load current sharing with multiple power supplies over the share bus, over temperature protection, and power supply shutdown.

Please refer to the appendix for the detailed schematic. The primary side consists of the input terminals, full bridge switches (QA to QD), the current sense transformer (T3) and the main transformer (T2). The ADP1046A (U1, on daughter card) resides on the secondary side and is powered via the USB 5V via an ADP3303 LDO (U2, on daughter card) present on the same daughter card. The gate signal for the primary switches comes from the ADP1046A through the iCouplers ADuM5230 (U14, U15) that provide isolation and power. The output of the iCoupler is connected to a buffer as it can source only 10mA of current. This buffer (network consisting of Q5 and Q6, Q7 and Q8, Q9 and Q10, Q11 and Q12) is used to drive the full bridge switches.

The secondary side power stage consists of the synchronous rectifiers (Q2 and Q3) and their respective drivers ADP3624 (U1), output inductor (L1), output capacitor (C4, C7), sense resistor (R17), and OrFET (Q1). Diode (D2) and capacitor (C6) form a peak detector that drives the OrFET along with the charge pump circuit. Capacitors (C23, C64, C67) provide high frequency decoupling to lower EMI.

Resistor (R10) converts the current into a voltage. The CS1 fast over current flag is comparator based and trips at 1.2V. Thermistor (RT1) is placed close to the OrFET on the board allowing over temperature protection functionality to be implemented.

Also present on the secondary is the current sharing circuitry, flag LEDs (D11-D12), and communications port to the software through the I2C bus.

CONNECTORS

The connections to the evaluation board are shown below.

Connector	Evaluation Board Function
J3	48V DC Input
J2	Ground Return for 48V DC Input
J4	12V DC Voltage Output
J5	Ground Return for 12V DC Voltage Output
J8, J9	I2C Connector
J10	Share Bus
J1	Daughter card

Table 2 - Evaluation board connectors

There is a 4 pin connector for I2C communication. This allows the software to communicate with the evaluation board through the USB port of the PC. Instead of using an auxiliary supply, the board uses the 5V input from the USB port, and generates 3.3V using an LDO for the ADP1046A. The synchronous rectifier drivers (ADP3624) are also powered by the 5V USB, but are powered from the main 12V output after the output is in regulation.

Connectors (J8 and J9) are identical and are connected in parallel to each other to allow multiple boards to be connected to the same I2C bus in a daisy chain configuration. Each board consumes between 150mA and 250mA depending on the conditions. Particular care must be taken to not overload the USB 5V rail. Some USB ports, especially those connected at a hub may shut down if overloaded and cause communication problems. In such cases an external 5V power supply is recommended to power the board between test point TP44(+) and TP21(-).

Pin	Evaluation Board Function
1	5V
2	SCL
3	SDA
4	Ground

Table 3 - J7, J8, J9 connections

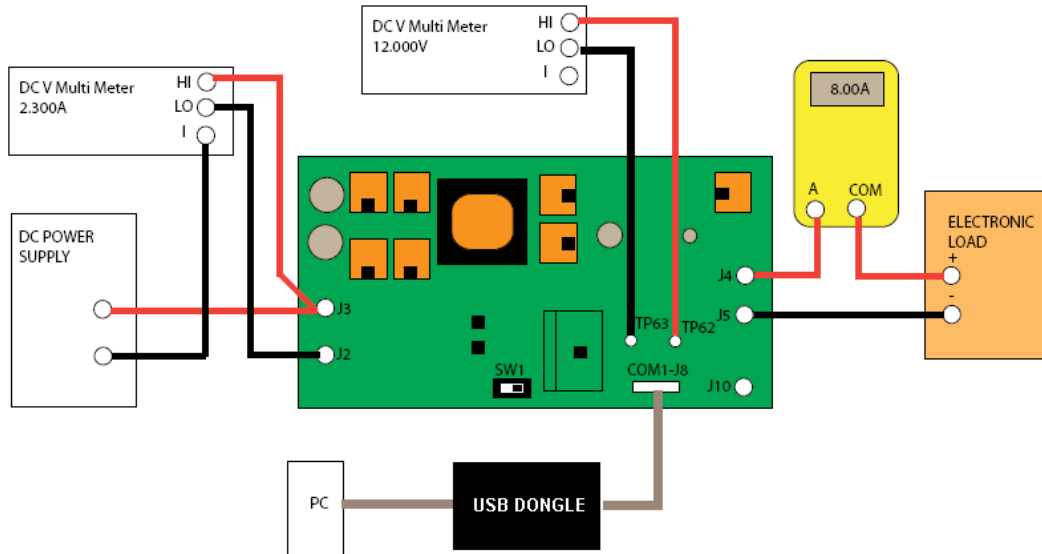


Figure 2 - Test configuration for the evaluation board

SETTING FILES AND EEPROM

The ADP1046A communicates with the GUI software using the I2C bus.

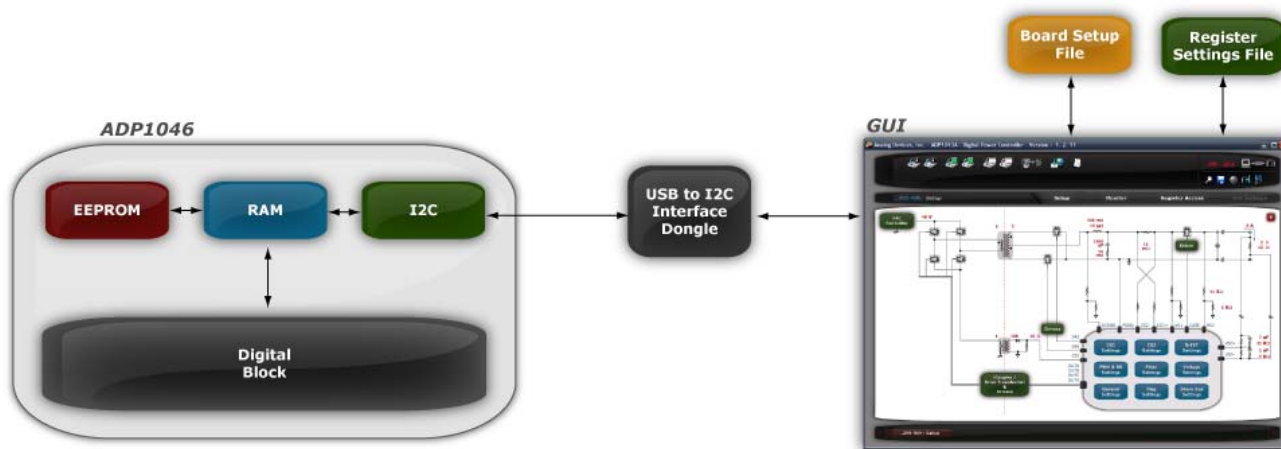


Figure 3 - ADP1046A and GUI interaction

The register settings (having extension .46r) and the board settings (having extension .46b) are two files that are associated with the ADP1046A software. The register settings file contains information that govern the functionality of the part such as the over voltage and over current limits, softstart timing, PWM settings, etc. The ADP1046A stores all its settings in the EEPROM. When the ADP1046A is connected to the USB dongle, the LDO powers the IC and the GUI downloads the settings from the registers of the ADP1046A. It is possible to save these settings in a file for later use through the GUI. Older register settings are overwritten when new files are loaded.

Information about the board, such as current sense resistor, output inductor and capacitor values is stored in the board setup file (extension .46b) and can be stored to Page 2 of the EEPROM. This information is necessary for the GUI to display the correct information in the 'Monitor' tab as well as 'Filter Settings' window. The ADP1046A does not need this information in order to operate, but the GUI will need it in order to show the values correctly in the 'Flags and Settings' window. The entire status of the power supply such as the OrFET and synchronous rectifiers enable/disable, primary current, output voltage and current can be digitally monitored and controlled through software. Always make sure that the correct board file has been loaded for the board currently in use.

Each ADP1046A chip has trim registers for temperature, input current and output voltage and current. These can be configured during production and are not overwritten whenever a new register settings file is loaded. This is done in order to retain the trimming of all the ADCs for the corresponding environmental and circuit conditions (component tolerances, thermal drift, etc.). A guided wizard called 'Auto Trim' is started which trims the above mentioned quantities so that the measurement value matches the value displayed in the GUI.

In the following pages it will be shown that the ADP1046A can be easily programmed to modify the behavior of the PSU under different fault and load conditions without any hardware changes. All the changes are purely through software and do not require desoldering components and replacing them with new values to specify a different operating condition

BOARD EVALUATION

EQUIPMENT

- DC Power Supply
- Electronic Load
- Oscilloscope with differential probes
- PC with ADP1046A GUI installed
- Precision Digital Multimeters (HP34401 or equivalent - 6 digits) for measuring DC current and voltage

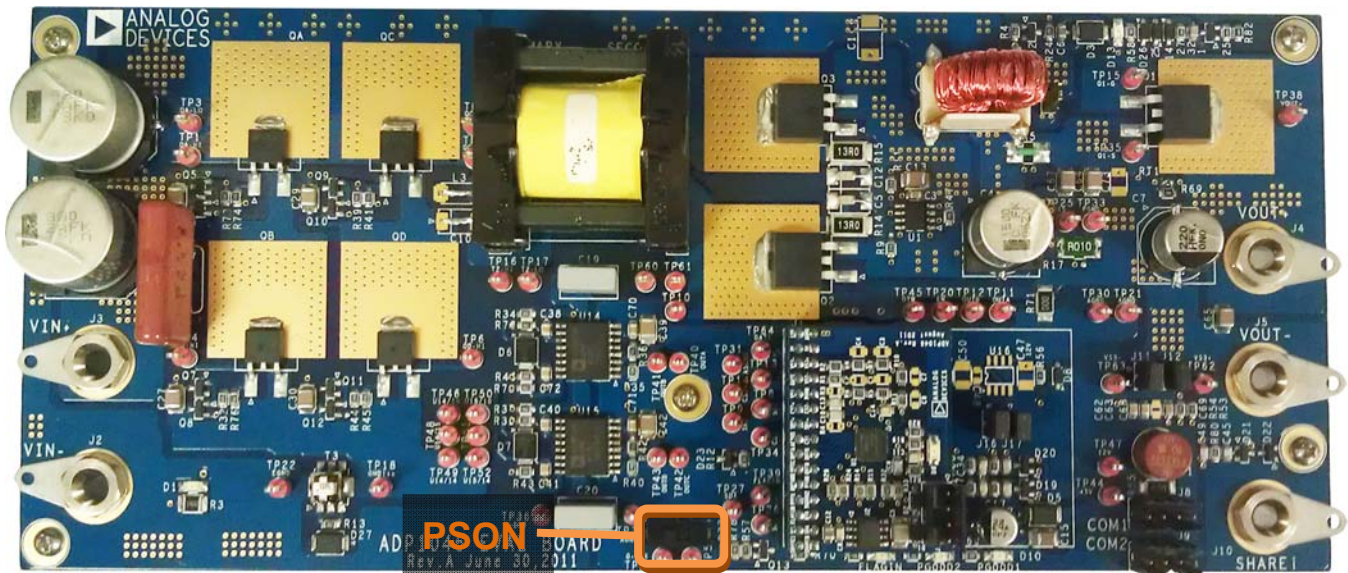


Figure 4 - 100W evaluation board showing PS_ON hardware switch

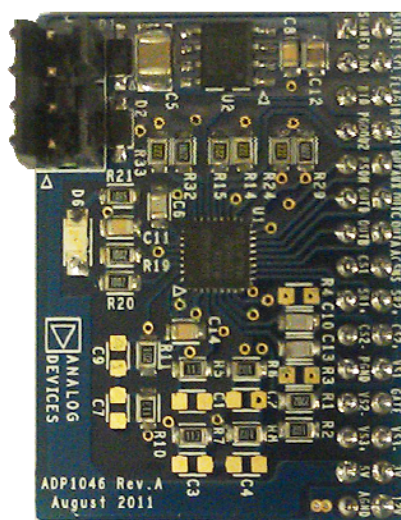


Figure 5 - ADP1046A daughter card

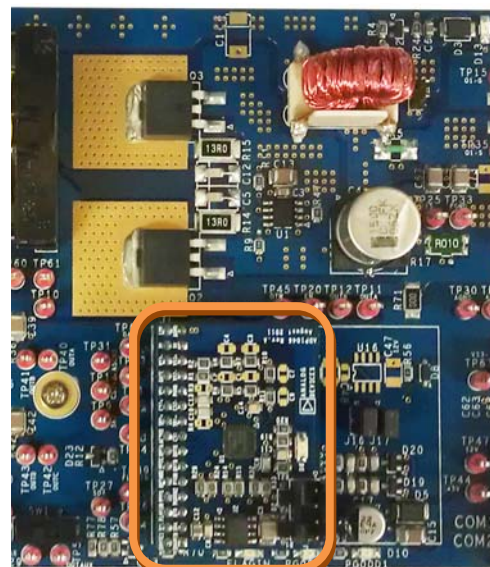


Figure 6 - Daughter card mounted on 100W board

SETUP

NOTE: DO NOT CONNECT THE USB CABLE TO THE EVALUATION BOARD UNTIL THE SOFTWARE HAS FINISHED INSTALLING

- 1) Install the ADP1046A software by inserting the installation CD. The software setup will start automatically and a guided process will install the software and the drivers for the USB dongle.
- 2) Insert the daughter card in connector J1 as shown in Figure 4.
- 3) Ensure that the PS_ON switch (SW1 on schematic) is turned to the OFF position. It is located on the bottom left half of the board (Figure 4).
- 4) Connect the evaluation board to the USB port on the PC using the “USB to I2C interface” dongle.
- 5) The software should indicate the ADP1046A has been located on the board. Click “Finish” to proceed to the Main Software Interface Window. The serial number reported on the side of the checkbox indicates the USB dongle serial number. The windows also displays the device I2C address underneath the serial number.



Figure 7 - ADP1046A address in the GUI

5. If the software does not detect the part it enters into simulation mode. Ensure that the connector is connected to J8/J9 (on main board) or J7 (on daughter card). Click on 'Scan for ADP1046A now' icon (magnifying glass) located on the top right hand corner of the screen.



Figure 8 - "Scan for ADP1046A Now" icon

5. Click on the “Load Board Settings” icon (fourth button from the left) and select the ‘ADP1046A_100W board.46b’ file. This file contains all the board information including values of shunt and voltage dividers. Note: All board setting files have an extension of .46b

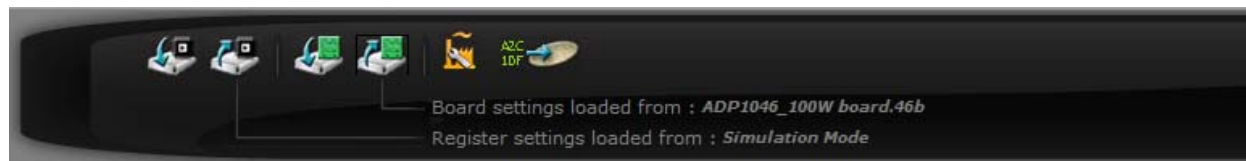


Figure 9 - Different icons on dashboard for loading and saving .46r and .46b files

6. **The IC on the evaluation board comes preprogrammed and this step is optional.** The original register configuration is stored in the ADP1046A_100KHz_Hard_switching.46r register file. Note: All register files have an extension of .46r. The file can be loaded using the second icon from the left in Figure 9.

7. Connect a DC power source (48VDC nominal, current limit to 5A) and an electronic load at the output set to 8A.

8. Connect a voltmeter on the output (connectors J4 and J5) and a differential scope probes (optional) between test points TP16 and TP17. Ensure that the differential probes are used and the ground of the probes are isolated if measurements are made on the primary and secondary side of the transformer simultaneously).

9. Turn the PS_ON switch (SW1 on schematic) to the ON position.

10. The evaluation board should now up and running, and ready for evaluation. The output should now read 12VDC.

11. Click on the 'Monitor' tab and then on the 'Flags and Readings' icon. This window provides a snapshot of the entire state of the PSU in a user friendly window.

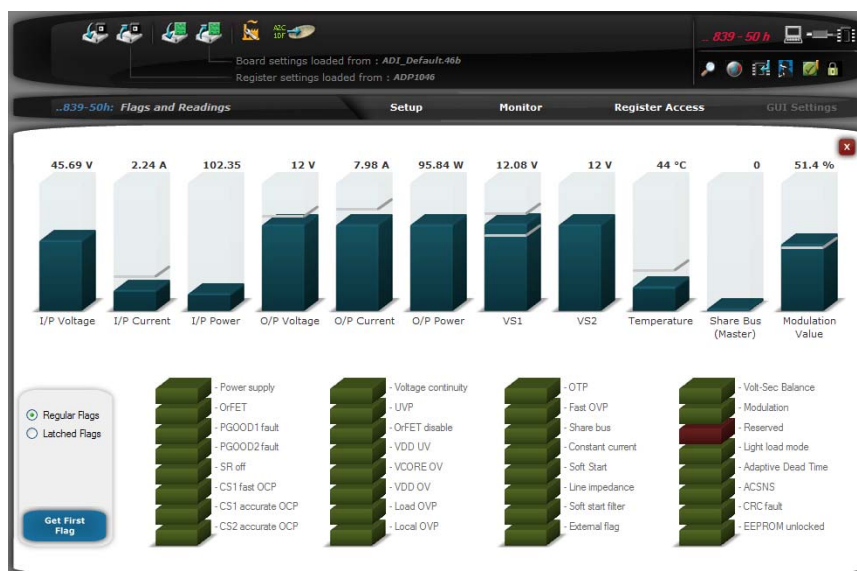


Figure 10 - Monitor window in GUI

During power up, the ADP1046A is connected to the USB port (5V) and the LDO powers the IC. It takes 20 μ s for VCORE (pin 26) to reach an internal voltage of 2.5V. After this, the IC downloads the contents of the registers into the EEPROM.

After successful startup and in steady state condition, 5 LEDs on the board provide the status of the board. All except the D12 (or FLAGIN) LED will be turned ON indicating that there are no faults detected such as over voltage or over current. In case of a fault the PGOOD1 or PGOOD2 LEDs will be turned OFF indicating that some flag has tripped due to an out of bounds condition. The monitor window will display the appropriate state of the PSU.

LED	Location	Description
D1 (Red)	Bottom left	Indicates input voltage is present
D10 (Yellow)	Bottom right	PGOOD1 signal (active low)
D11 (Red)	Bottom right	PGOOD2 signal (active low)
D12 (Red)	Bottom right	FLAGIN signal
D13 (Red)	Top right	Indicates ORFET is turned ON

Table 4 – List of LEDs on the evaluation board

ADP1046A PROGRAMMING SOFTWARE

The goal of this evaluation kit is to allow the user to get an insight into the flexibility offered by the extensive programming options offered by the ADP1046A. Several test points on the board allow easy monitoring of the various signals. The user can also use the software to program multiple responses (such as disable power supply or turn off the OrFET) for various fault conditions.

The following sections give provide a good overview of the software as well as the test data experiments that the user might typically evaluate. There are 9 main windows (blue icons in Figure 11) located in the 'Setup' window in the GUI where the user can program and evaluate the PSU.

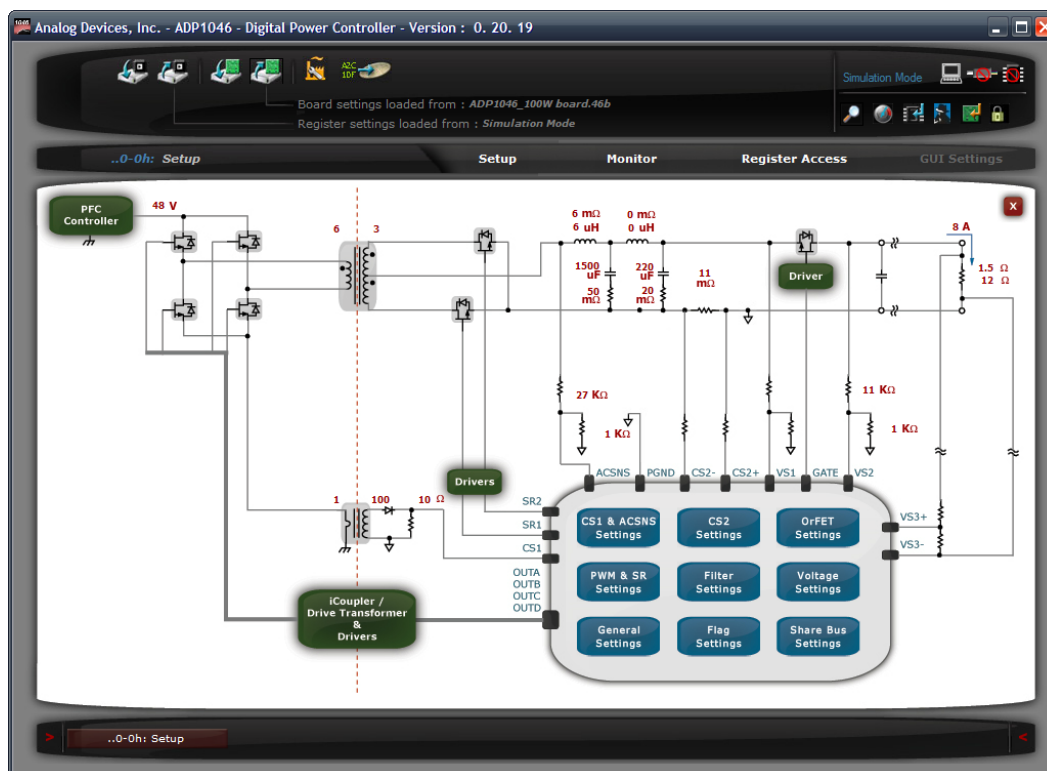


Figure 11 - Main Setup window of ADP1046A GUI

FLAGS SETTINGS CONFIGURATIONS

The flags can be programmed in a single window by hitting the 'Flag Settings' icon in the 'Monitor' tab in the GUI and the state of the power supply can be monitored by clicking on the 'Flags and Readings' icon in the 'Monitor' tab.

This monitor window shows all the fault flags (if any) and the readings in one page. The 'Get First Flag' button determines the first flag that was set in case of a fault event.

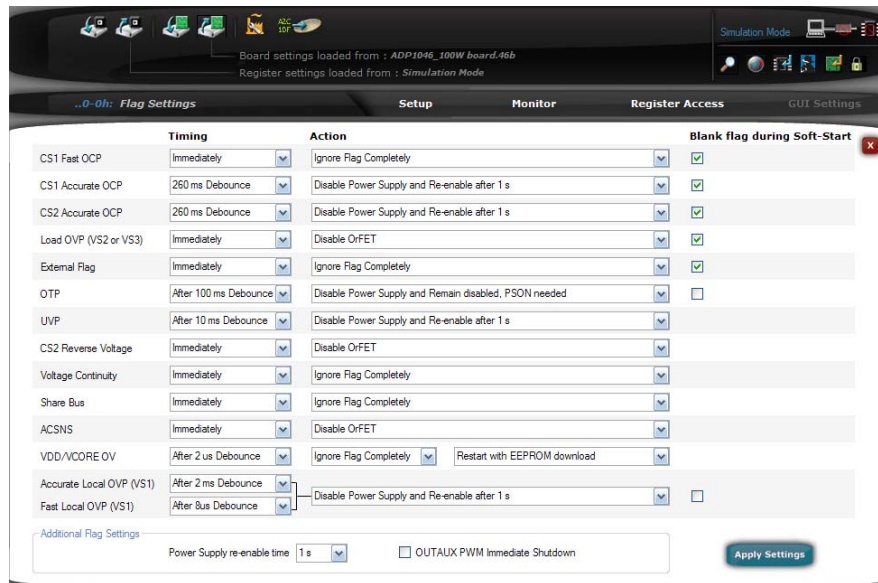


Figure 12 - Fault configurations

The ADP1046A is programmed to respond to the various fault conditions in the Flag Settings Window.

ACTION: Ignore Flag Completely, Disable Synchronous Rectifiers, Disable ORFET, and Disable power Supply are some of the operations available in this column.

TIMING: This defines if an ACTION is taken immediately or after a debounce. Debounce is a term used for a wait period in digital circuitry. After a flag signal is detected, the debounce routine checks if the flag signal remains in its changed state for the entire programmed debounce period before taking any action. This prevents the ADP1046A from reacting to false positives.

GENERAL SETTINGS AND SOFTSTART

This section programs the PS_ON turn on and softstart timing. The power supply (PSU) can be turned on with a manual switch (hardware PS_ON), a software enabled switch (SW PS_ON), or both with a programmable delay. It contains the capability of adding a soft start to the primary and secondary switches (synchronous rectifiers) and also displays the temperature of the thermistor for over temperature protection.

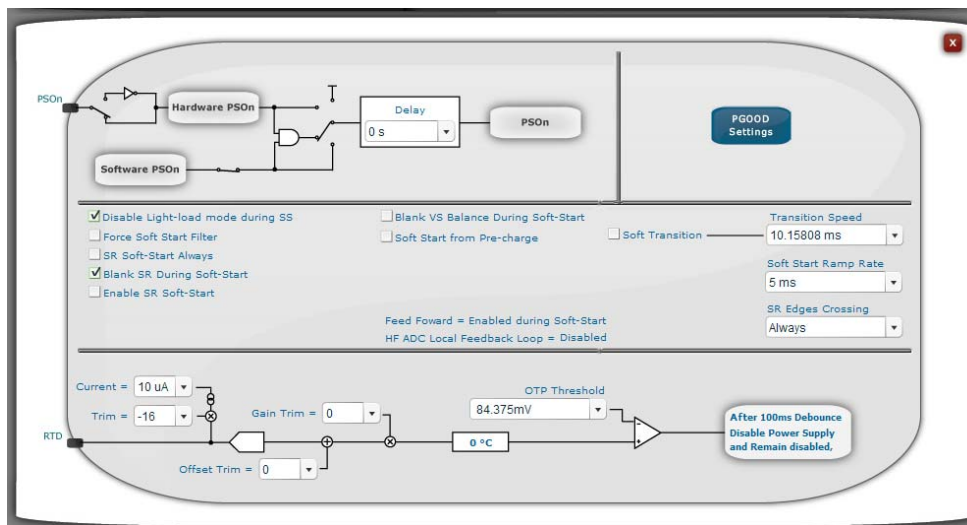


Figure 13 - General Settings window showing PS_ON, temperature flags, and softstart settings

Some test results are provided to better appreciate the flexibility of part. In addition to these some suggestions for further exploration are also provided.

- A. **PS_ON Turn on Delay:** Figure 14 and Figure 15 show the startup sequence with a 0.5 second and 2 second delay respectively.

This test was conducted by monitoring the PSOn signal (TP29), the output voltage (J4 and J5) and setting a programmable delay using the drop down menu. Monitoring the synchronous rectifier (test point SR1 and SR2) is optional.

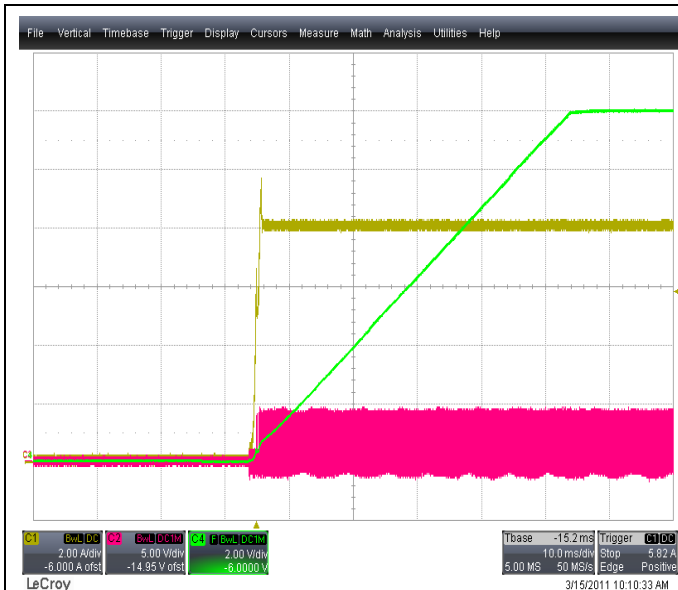


Figure 14 – Softstart ramp, 48VDC, 8A load, with synchronous rectifiers enabled during softstart.
Green trace: Output voltage
Yellow trace: Output load current
Red trace: SR signals



Figure 15 - Startup with softstart from pre-charge
Green trace: Output voltage
Yellow trace: Output load current

B. Softstart ramp and SR blanking: Figure 16 and Figure 17 show the startup sequence with the synchronous rectifiers enabled/disabled with a 20ms and 40ms softstart ramp respectively.

This test was conducted by monitoring the output voltage (J4 and J5) and the test points SR1/SR2 during a startup condition. The 'Blank SR during softstart' check box and the 'Softstart ramp rate' dropdown menu were appropriately selected.

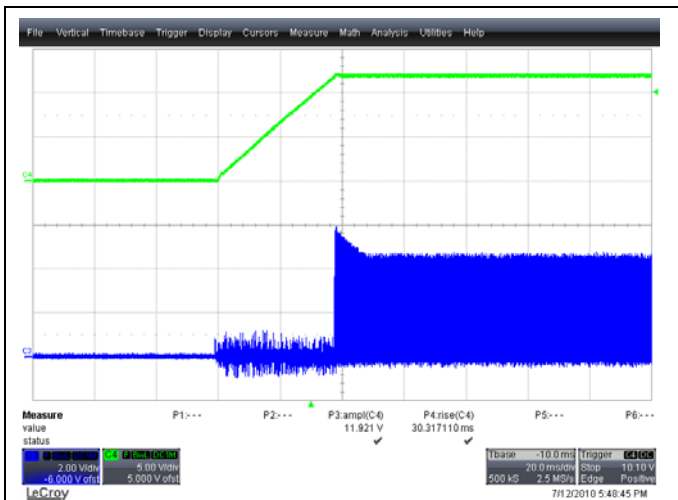


Figure 16 - 40ms softstart, 48VDC, 8A load, with synchronous rectifiers disabled during softstart
Upper trace: Output voltage, 5V/div, 20ms/div
Lower trace: Test point SR1, 2V/div, 20ms/div

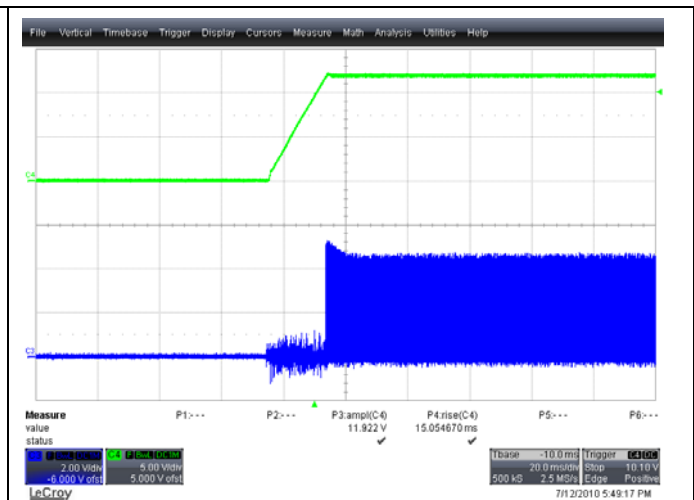
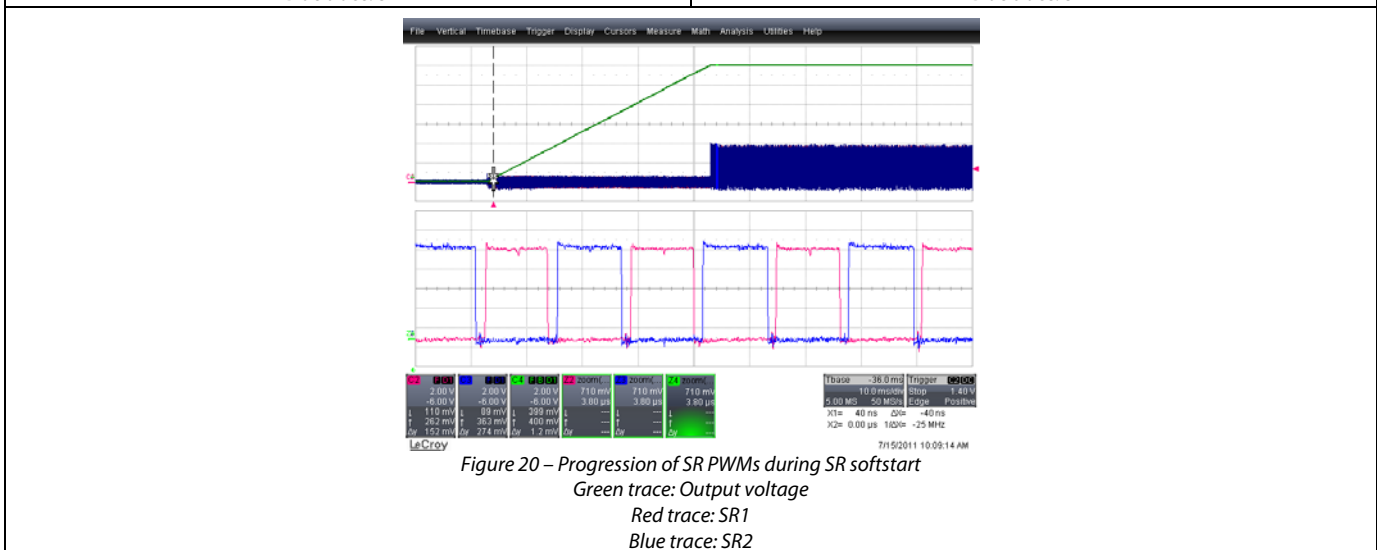
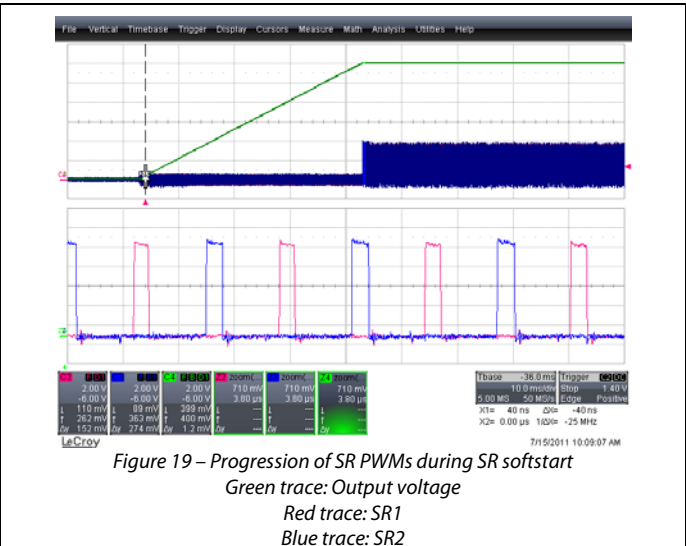
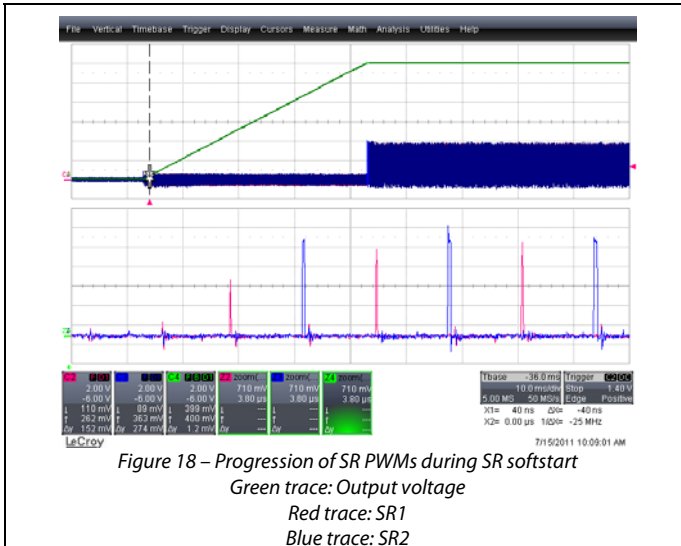


Figure 17 - 20ms softstart, 48VDC, 8A load, with synchronous rectifiers disabled during softstart
Upper trace: Output voltage, 5V/div, 20ms/div
Lower trace: Test point SR1, 2V/div, 20ms/div

- C. **SR softstart:** This test shows the capability of the softstart ramp or fade in sequence applied to the synchronous rectifiers. The 'Enable SR softstart' button was checked. *Figure 18 – Progression of SR PWMs during SR softstart* Figure 18 to Figure 20 show a zoomed in snapshot of the duty cycle at the beginning and end of the softstart ramp.



Additional things to try:

- Implement different softstart timings in combination with different PS_ON delays.
- Use a dedicated softstart filter during softstart and choosing an aggressive normal mode filter.
- Use the filter transition feature to seamlessly change filters.
- Disable the OrFET allowing its body diode to conduct the output current. Then set different OTP thresholds.
- Use the SR Softstart to prevent a glitch in the output voltage.
- Enable softstart from pre-charge to reduce softstart time.

PWM AND SR SETTINGS

The switches on the primary and the synchronous rectifier timings are controlled in this window. This window programs the switching frequency, timings of the synchronous rectifier, the type of modulating edge (rising or falling), modulation type (positive or negative), and duty cycle.

The Pulse Skipping Mode is activated when the controller requires a duty cycle less than the modulation low limit to maintain output regulation.

Note 1: All the signals shown below represent the gate drive signals at the output pins of the IC.

Note 2: Although the switching frequency can be increased, the software does not account for the dead times and these have to be programmed manually by measuring the propagation delays between the output of the ADP1046A and the gate of the MOSFET. A 200ns delay is conservative for the evaluation board.

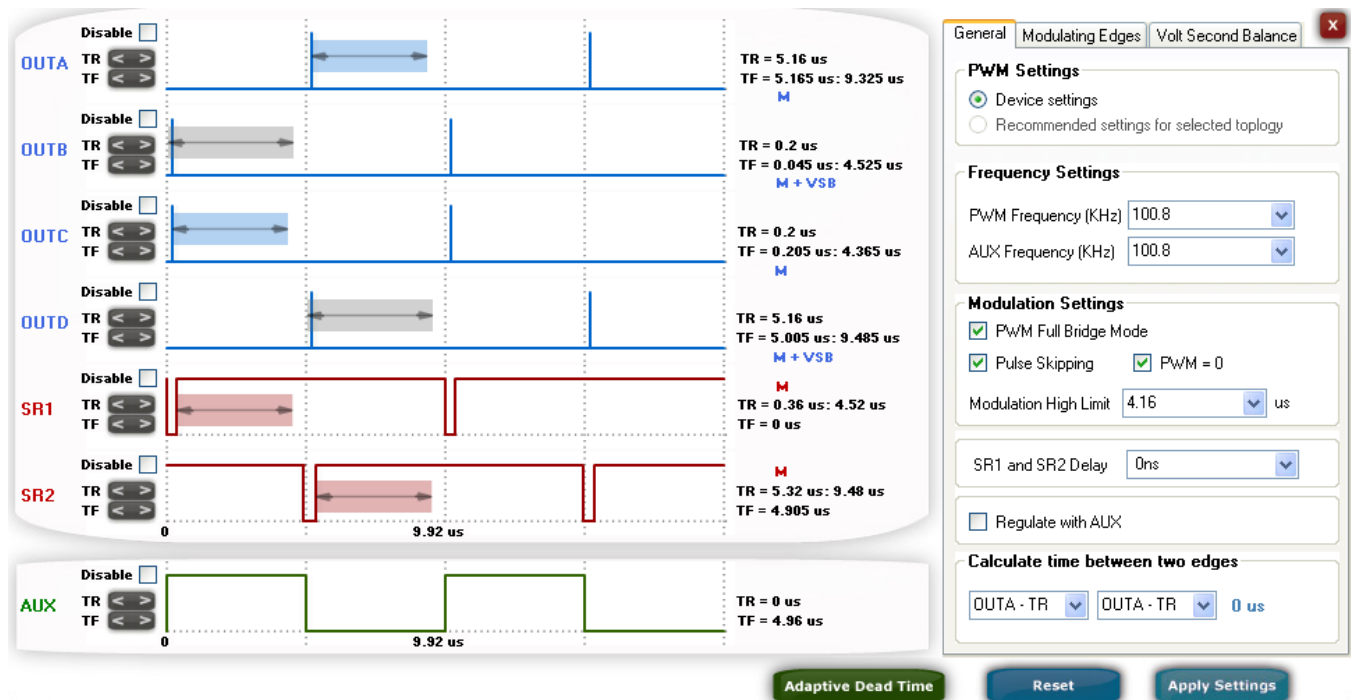


Figure 21 - PWM settings window for the evaluation board

Things to try:

- Referring to the schematic, turning on QA and QB for the entire period of $T_s/2$ (with appropriate dead times) and modulating only the bottom MOSFETs.
- Enabling/Disabling Pulse Skipping Mode and measuring standby power (by disabling the LEDs on the board additional power can be saved).
- Doubling the switching frequency. Note: The board is designed to operate at switching frequencies of up to 200kHz with air flow cooling (i.e. a fan). Beyond this point, switching losses may be dominant.
- Programming an imbalance in the ON times of the MOSFETs of each branch and evaluating Volt-Second Balance.
- Run the software in simulation mode and program the PWM settings for a different topology such as two switch forward.
- Align all SR edges to OUTA-D and adjust the primary-secondary propagation delay by using the dedicated SR delay.

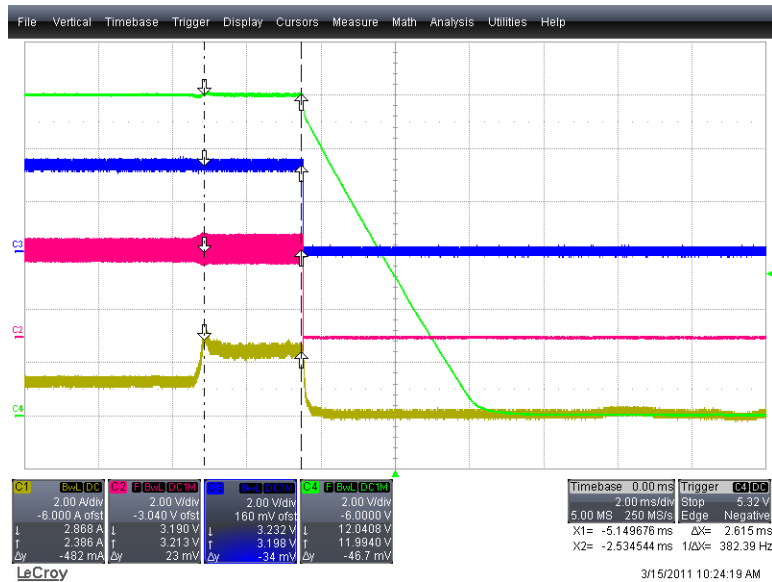


Figure 23 - Accurate CS1 OCP, 2.5ms debounce time
Green trace: Output voltage (discharged by load after shutdown)
Red and blue trace: PGOOD 1 and 2 signals
Yellow trace: Average Input Current

- B. **Volt Second Balance feature:** The CS1 settings window has the volt second feature that measures the average current in each leg of the full bridge topology. The algorithm reduces (or increases) the conduction time of each branch by varying the pulse width of the MOSFET gate signals applied to OUTB and OUTD depending if there was an increase (or decrease) of current in the corresponding branch. A maximum of 80 or 160ns can be accounted for by this algorithm.

This test was conducted by purposely introducing a mismatch of 75ns in the PWM settings window. This mismatch clearly shows that the transformer is close to saturation on one end. Figure 25 shows the imbalance and Figure 26 shows the corrected imbalance after the feature was turned on in the GUI by closing the switch. The primary current can be measured using a current probe and by using a small loop of wire in place of jumper L3 or C10 on the board.

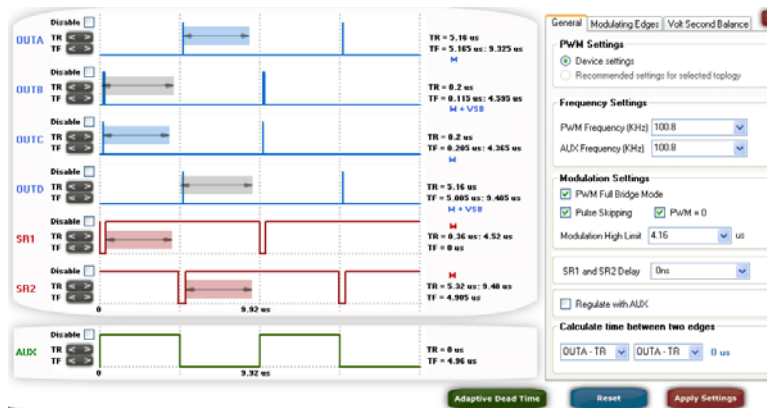


Figure 24 - PWM Settings for programmed 75ns Volt-Second imbalance on OUTB and OUTC



Figure 25 - Primary current with programmed imbalance between PWMs (less than 180µs), 8A load



Figure 26 - Primary current after Volt Second Balance implemented, 8A load

- C. **CS1 Fast OCP:** Figure 27 and Figure 28 show the CS1 fast OCP tripping under a shorted output. In this test the CS1 pulse by pulse current limit was tested during a shorted output. A shutdown was programmed after 4 repetitive OCP limits were triggered.

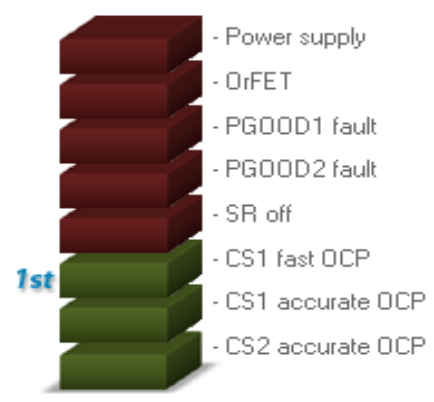
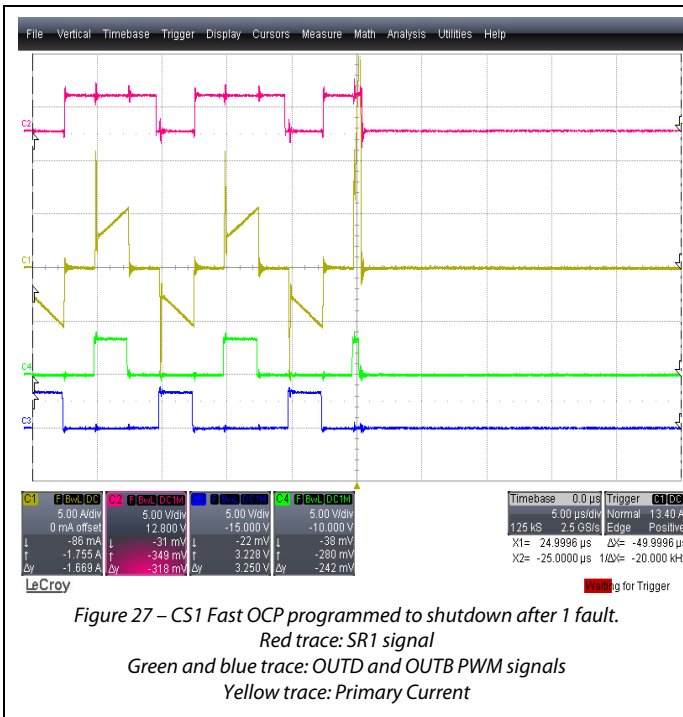


Figure 28 - Corresponding 'Flags and Readings' window. CS1 Fast OCP was the first flag that tripped

Additional things to try:

- a) Programming an external FLAGIN to trip the CS1 fast OCP comparator.
- b) Enabling/Disabling Volt-Second Balance and its associated gain.
- c) Measuring peak output power at maximum input voltage and by decreasing/increasing the debounce value.
- d) Use a higher CS1 timeout condition with an increased leading edge blanking time.
- e) Choosing a different value of R10 (on schematic) to get a different range of protection.

CS2 OR OUTPUT CURRENT SETTING

The output current settings window is accessed using the 'CS2 Settings' block. This window also features trimming registers, line impedance feature, threshold for over current protection (OCP), the light load threshold, and constant current mode.

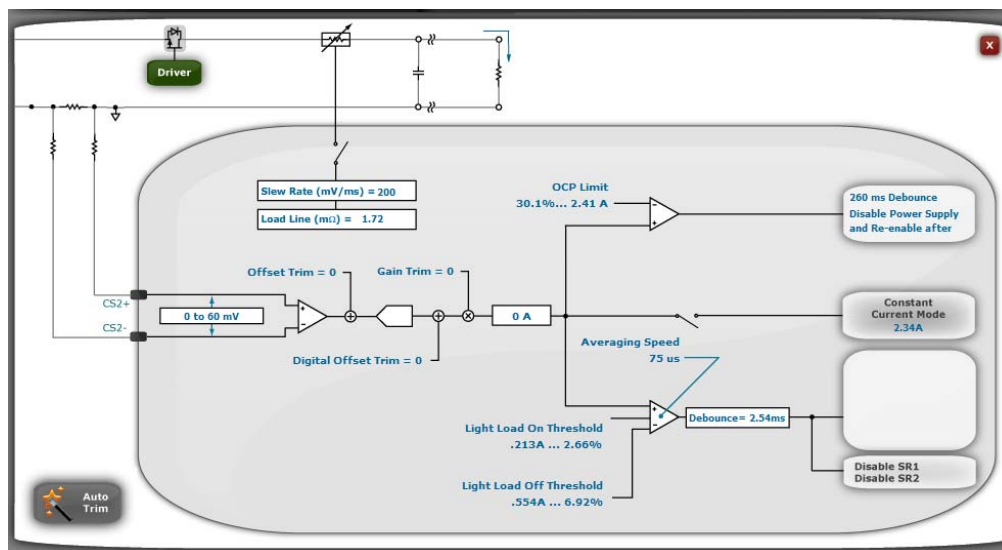
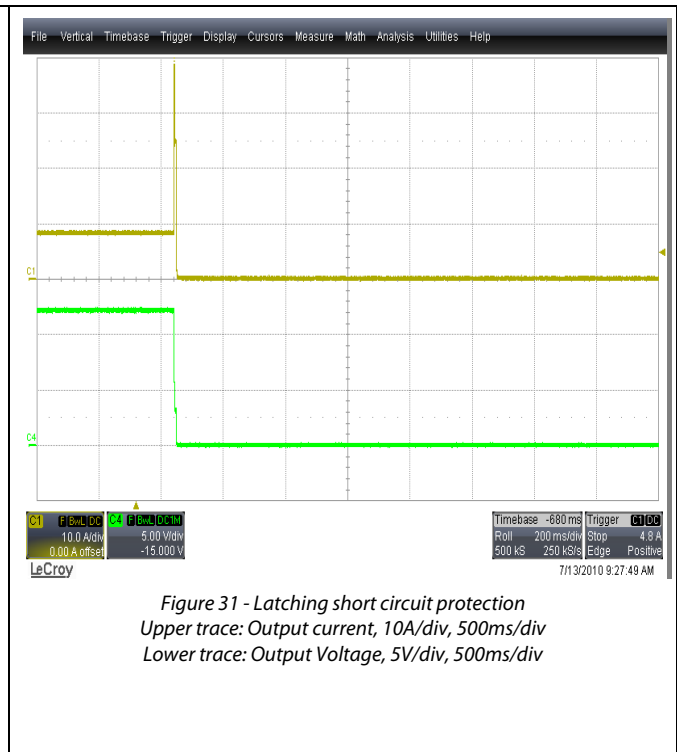
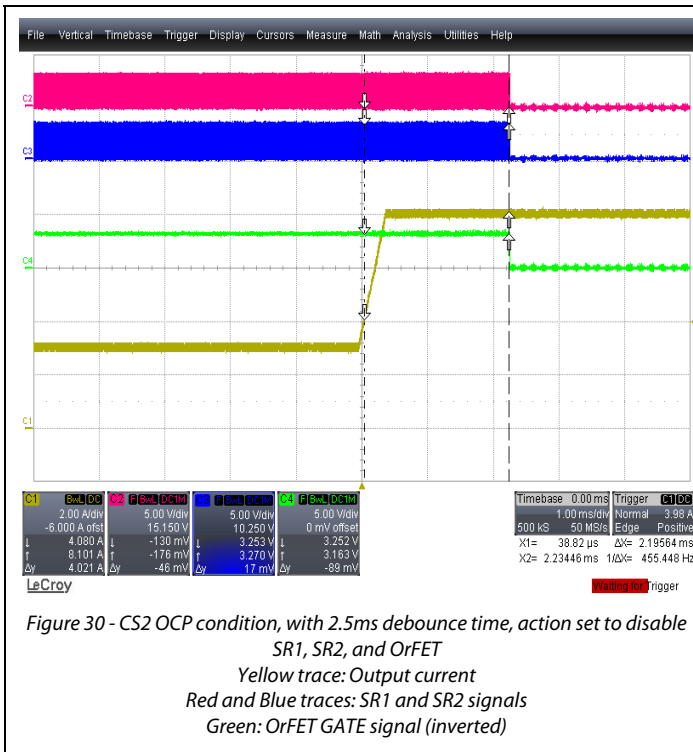


Figure 29 – CS2 Settings window

The following waveforms display some of the features that can be programmed using this window.

- A. **Over Current Protection (OCP):** Figure 30 and Figure 31 show hysteretic and latching OCP respectively. An over current condition can be easily created by shorting the load or increasing the output current beyond the OCP limit. Different reactions to the fault can be programmed by either re-enabling the PSU after 1 second or a complete shutdown through the drop down menus in the GUI.



Additional things to try:

- Setting a different light load thresholds and measuring its effect on efficiency.
- Using the line impedance feature to simulate the voltage drop through a 2 foot output cable.
- Reducing the current sense resistor value (R17) and changing the range of the full scale voltage drop on CS2+ and CS2-.
- Change the CS2 averaging speeds and see the effect on transient response from DCM to CCM.
- Setting different OCP limits and setting a different response such as disable all PWMs

LIGHT LOAD MODE

The ADP1046A can be programmed to optimize performance when the output current drops below a certain level. The light load threshold is set in a manner to reduce the losses in the synchronous rectifiers to enter into DCM and reduce the power loss in the SR drivers and increase efficiency. A hysteresis is provided on this threshold to avoid oscillations.

When operating in light load mode the light load mode flag and the SR off flag will be set as shown in the 'Monitor' window (Synchronous rectifiers turned red in figure below), and the light load filter settings will be used. Using this in combination with Pulse Skipping aids in reducing standby power consumption. The ACSNS flag is used to sense the voltage at the front side of the inductor connected to the transformer (T2).

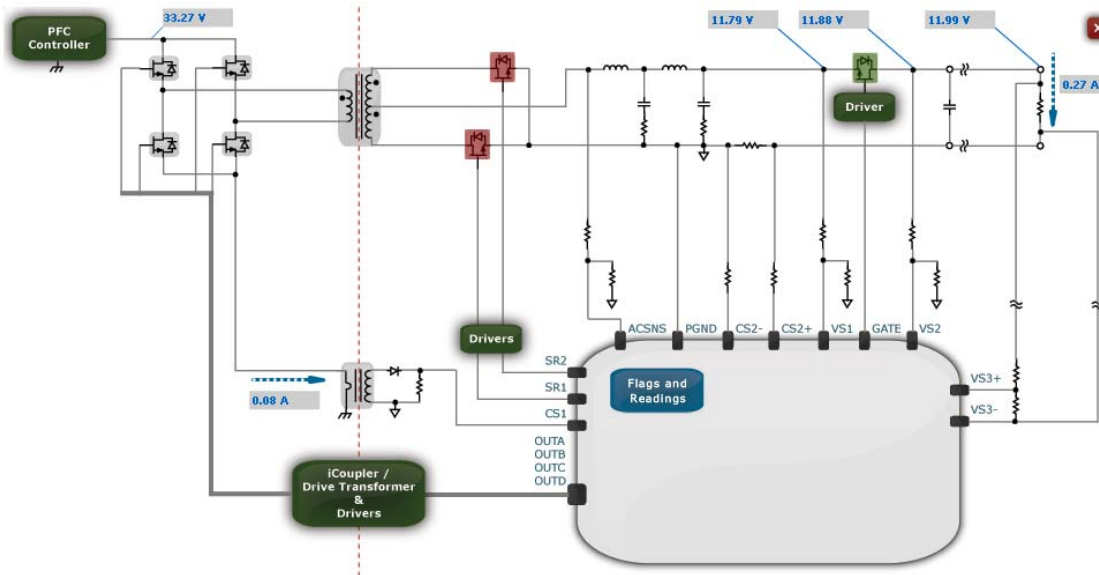


Figure 32 - SR Automatic Disabled in Light load mode



Figure 33 - ACSNS flag tripped during light load mode

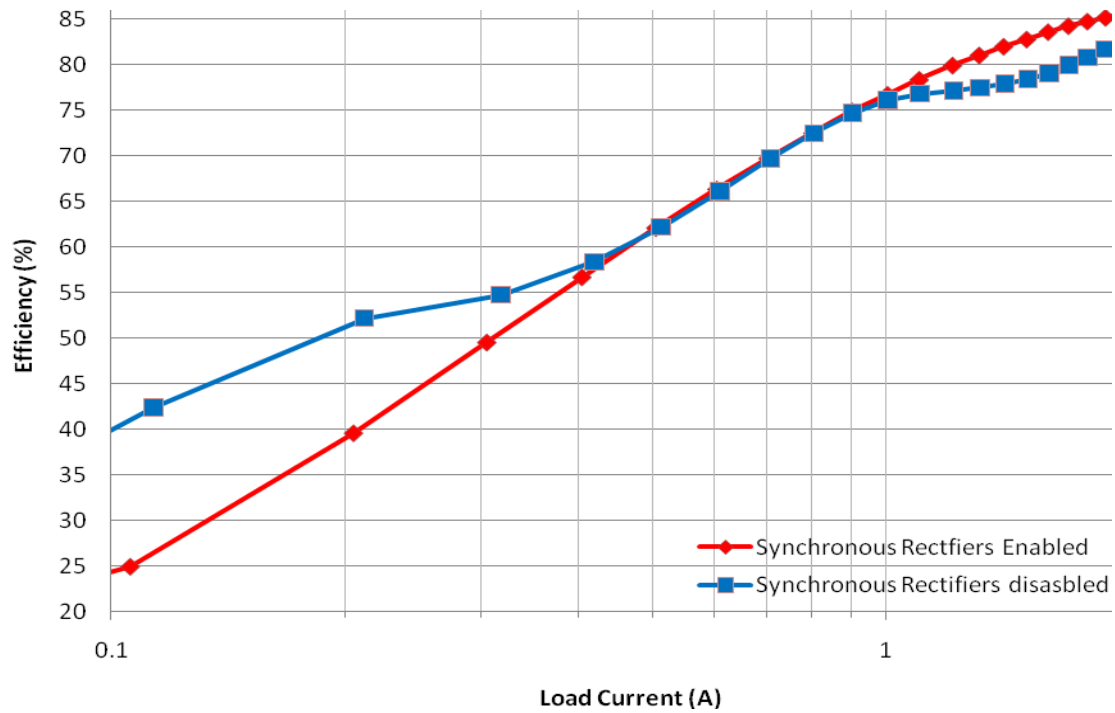


Figure 34 - Efficiency vs Light load current at 48VDC showing optimal light load threshold between 500-900mA

OUTPUT VOLTAGE SETTINGS

This window sets all the parameters related to the output voltage, including trimming, overvoltage protection (OVP) and undervoltage protection (UVP) protection. There are three points where the output voltage is sensed using the ADP1046A namely, before the ORFET (local OVP), after the ORFET (also local OVP), and at the load (remote OVP). An over voltage condition at the load is termed as remote OVP whereas at the other two locations is termed as local OVP.

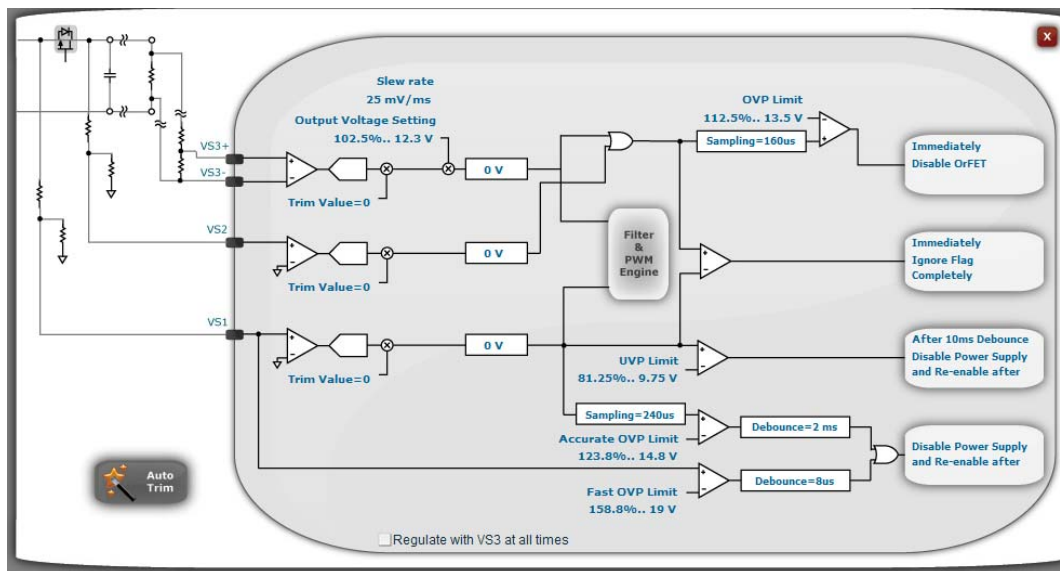
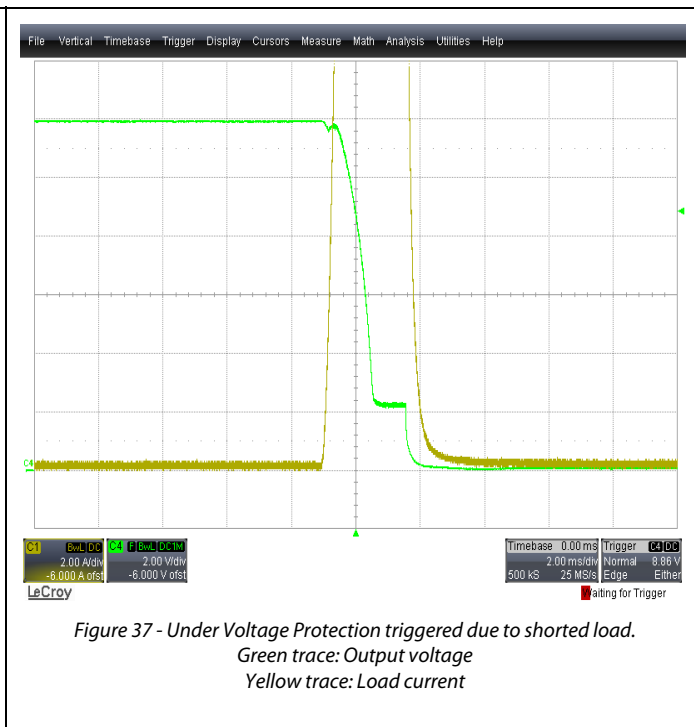
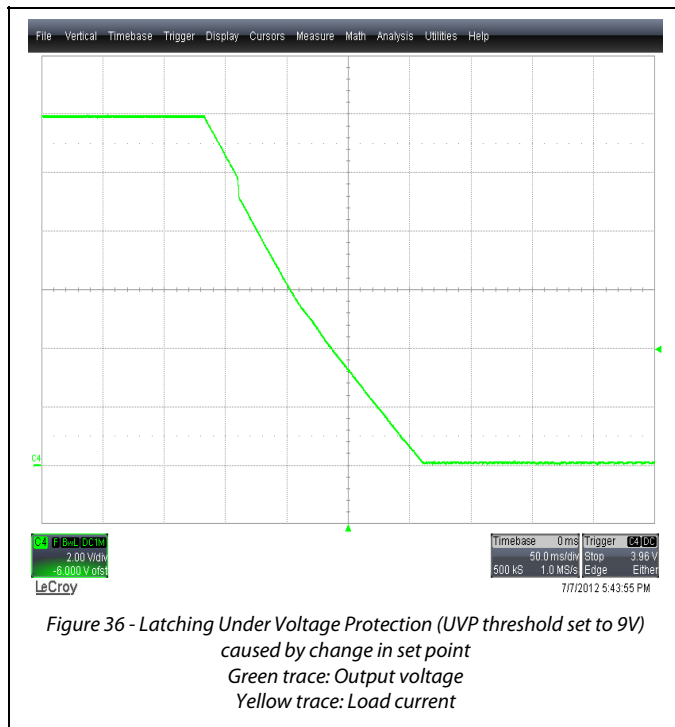


Figure 35 - Voltage Settings window

The following waveforms display some of the features that can be changed using this window.

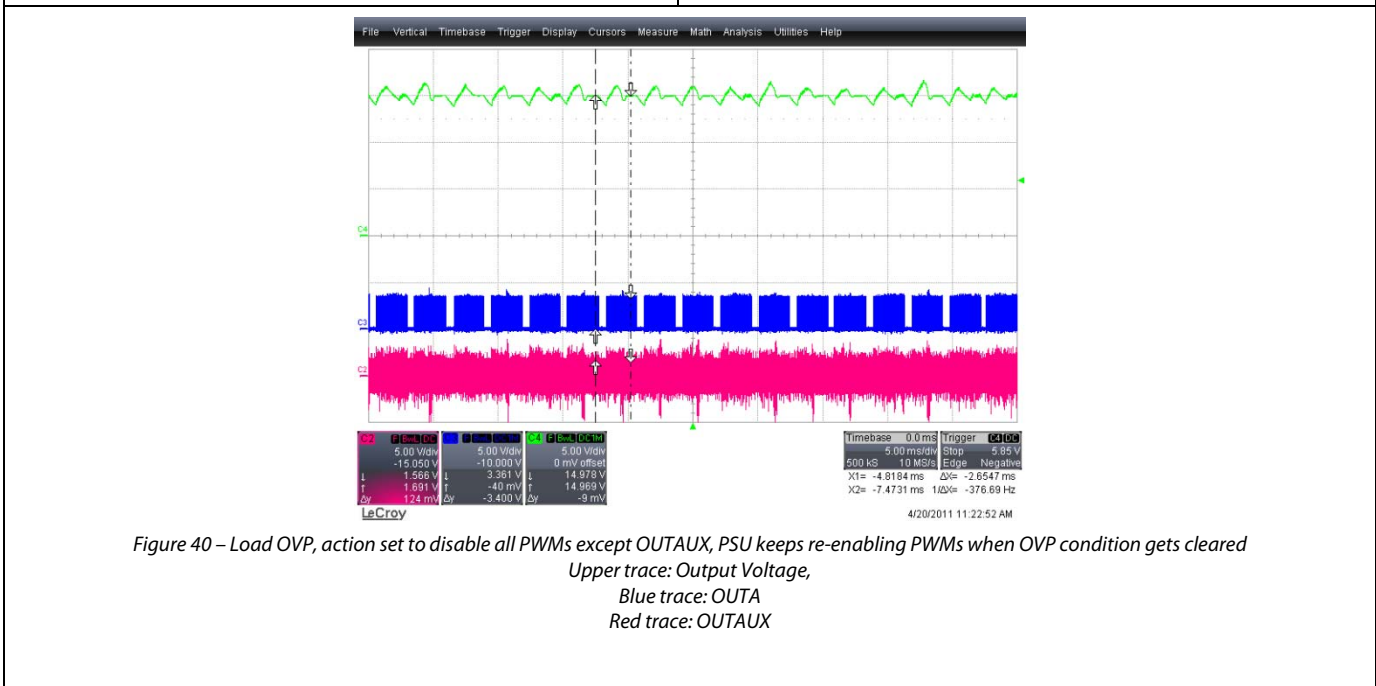
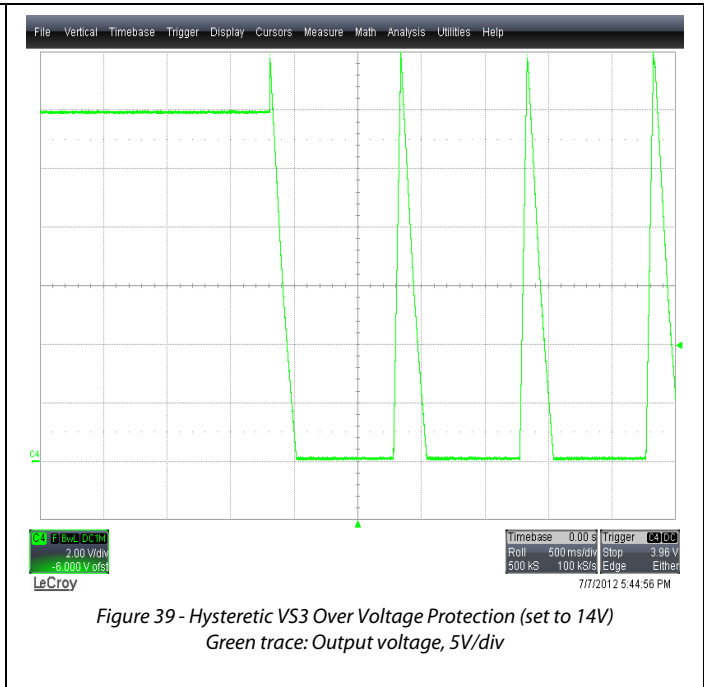
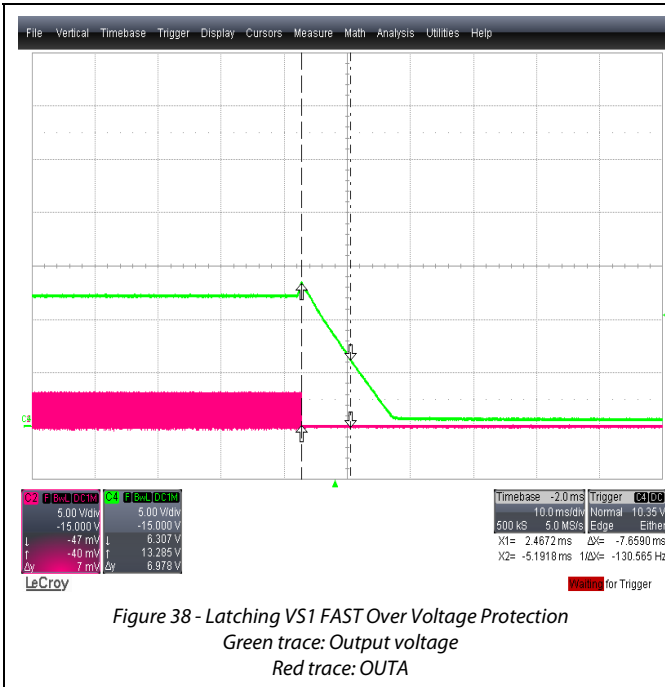
- A. **Under Voltage Protection (UVP):** Figure 36 and Figure 37 show latching and hysteretic UVP respectively.

This test can be conducted in a number of ways, the simplest of which would be to set the 'VS3 Output Voltage Setting' under the programmed UVP threshold using the drop down menu in the GUI. Alternately, the duty cycle can be clamped to a lower value than its required value. Under certain conditions even a shorted load or an internal short (shorting the synchronous rectifiers) can cause a UVP condition. Hysteretic (enable after 1 sec) and latching (remain disabled, only PS_ON can re-enable) are the programmed choices for the faults.



B. Over Voltage Protection (OVP): Figure 38 and Figure 39 show latching and hysteretic OVP respectively.

This test can be easily performed setting the VS3 regulation point beyond the OVP threshold. Another method how an OVP flag can be tripped is by suddenly opening the control loop (open R10 or short R11 on the daughter card). Hysteretic (enable after 1 sec) and latching (remain disabled, only PS_ON can re-enable) are the programmed choices for the faults in the drop down menu provided in the GUI.



Additional things to try:

1. Using Auto Trim to precisely set the voltage at the terminals of the board.
2. Setting different fast and accurate OVP limits.
3. Regulating with VS3 at all times and evaluating the transient response.
4. Raise the bus voltage higher than the nominal value and see the OrFET turn off.
5. Use this voltage continuity feature to detect a voltage drop more than 100mV between VS1 and VS2 or VS2 and VS3.

DIGITAL FILTER SETTINGS AND TRANSIENT ANALYSIS

The digital filter can be changed using the software by manipulating the position of the poles and zeros (red and green circles in the figures below) in the Laplace domain. The ADP1046A allows three different sets of compensation to be programmed, one at light load, one at heavy load, and one for soft-start.

A type 3 compensation is implemented in the ADP1046A. The first pole (to eliminate steady state error) is indirectly accessed through the placement of the first zero. The second pole can be freely placed (ideally at the ESR zero), but the third pole (high frequency gain) is fixed at half the switching frequency. There is an additional constraint in moving the poles and zeros and it is that the software allows the poles and zeros to be moved only in a manner that keeps the slopes between them equal to be $\pm 20\text{dB/dec}$.

WARNING: While varying the compensation parameters is possible while the part is running, the wrong combination of parameters can cause the system to become unstable.

The following figures are provided to demonstrate the performance of the PSU as well as the ease with which the GUI can be used to change the dynamic response of the system.

- A. **Closed Loop System:** Figure 41 and Figure 42 show the bode plot of the system. The validity of this plot depends highly on the proper characterization of the output inductor and capacitor and their respective parasitic components namely the DC resistance and ESR. The GUI displays the closed loop crossover frequency, phase margin as well as individual gain and phase plots for the LC filter, digital filter and the closed loop scenarios.

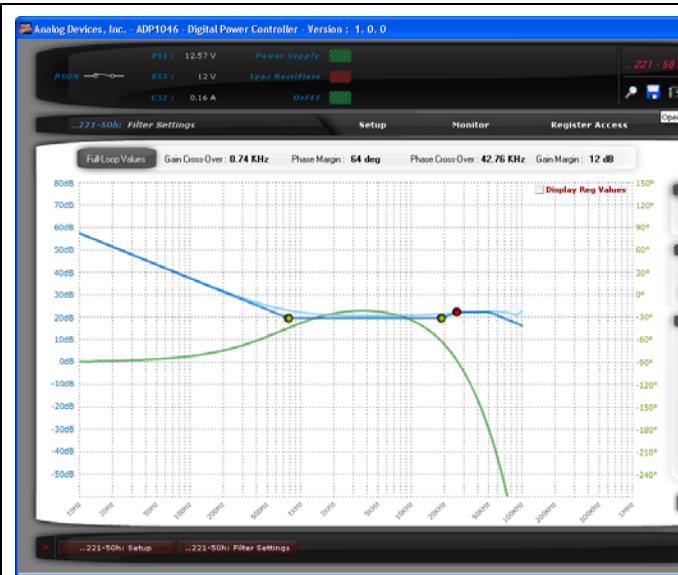


Figure 41 – Digital compensation for Light Load mode (DCM)

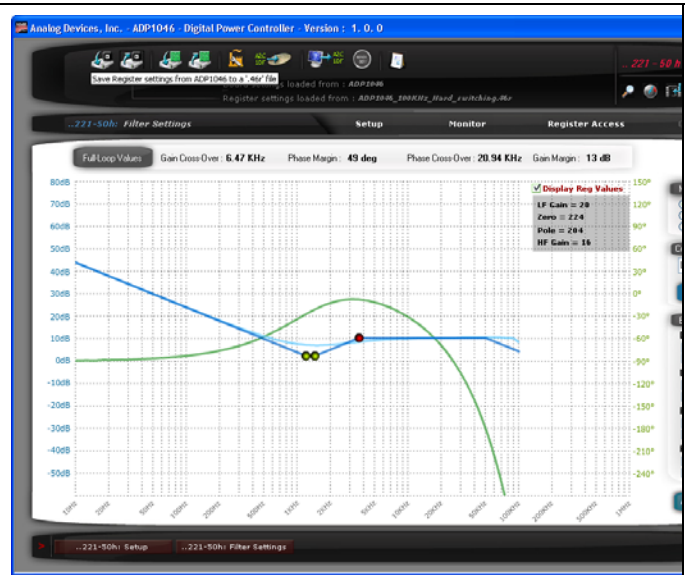


Figure 42 - Digital compensation for normal or heavy load (CCM)

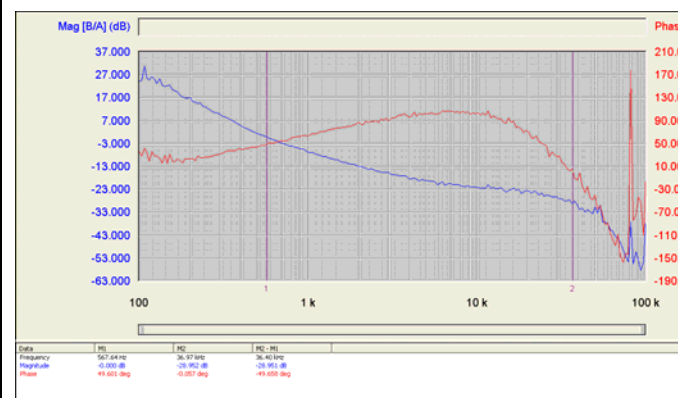


Figure 43 – Loop gain for DCM. Injected noise of 100mVpp.
Crossover frequency at 567Hz
Phase margin of 50 degrees

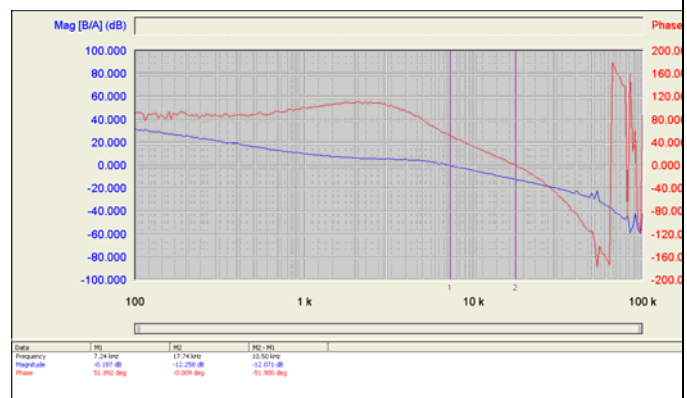


Figure 44 – Digital compensation for CCM. Injected noise of 500mVpp.
Crossover frequency at 7.24KHz
Phase margin of 51 degrees

B. Transient Response for load step:

A dynamic load from 0-8A (slew rate 1A/μs) at a frequency of 20-25Hz can be set up to conduct this test. The output voltage must be measured at the connectors J4 and J5 with very small loop area between the positive and negative of the probes to minimize noise.

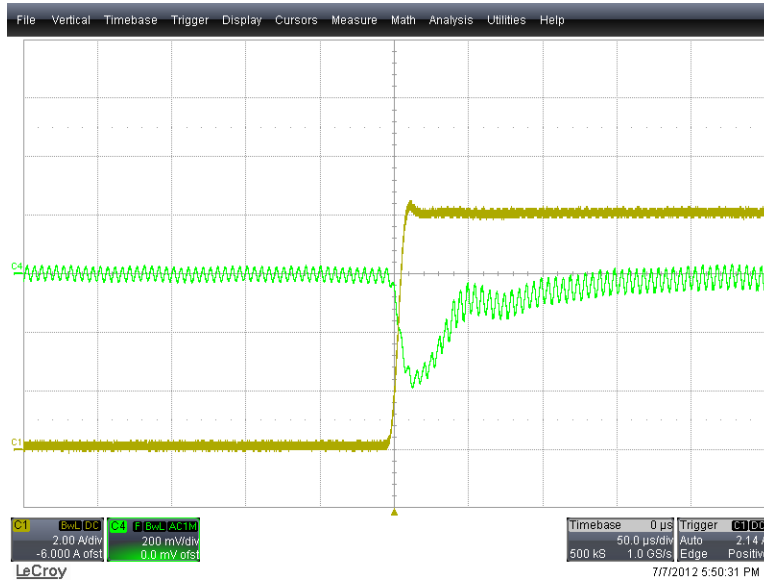


Figure 45 - Load step, 0A - 8A step load, 48VDC, SR enabled at 0A
Green trace: AC coupled output voltage
Yellow trace: Load current

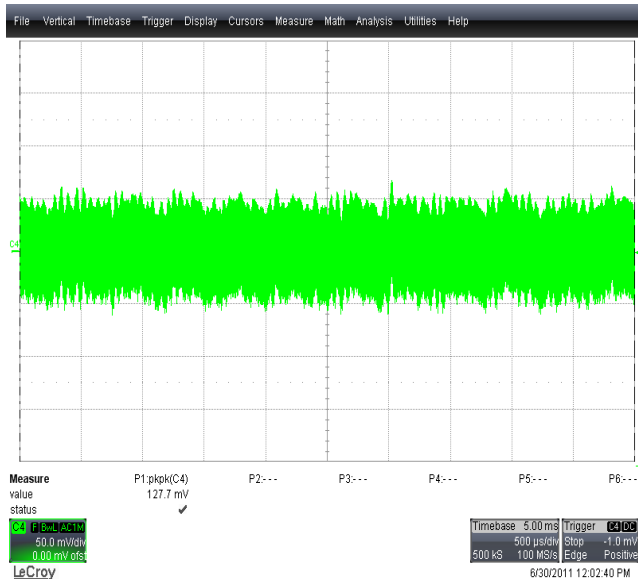


Figure 46 - High frequency content of output voltage ripple at 8A load, 48VDC
Green trace: AC coupled output voltage

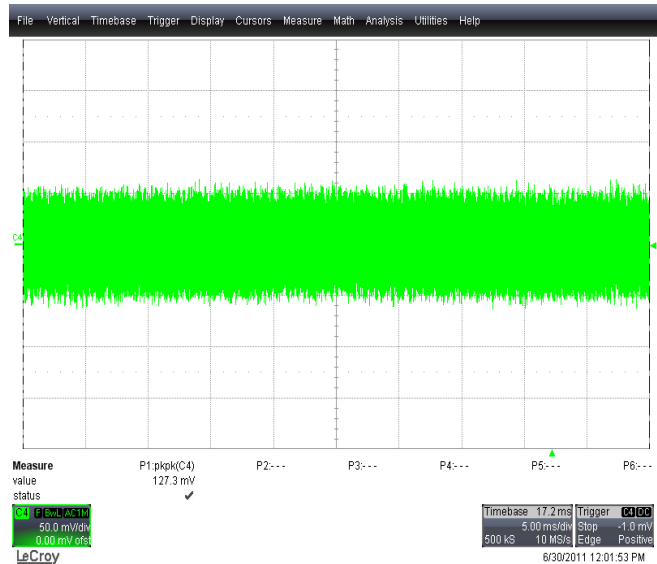
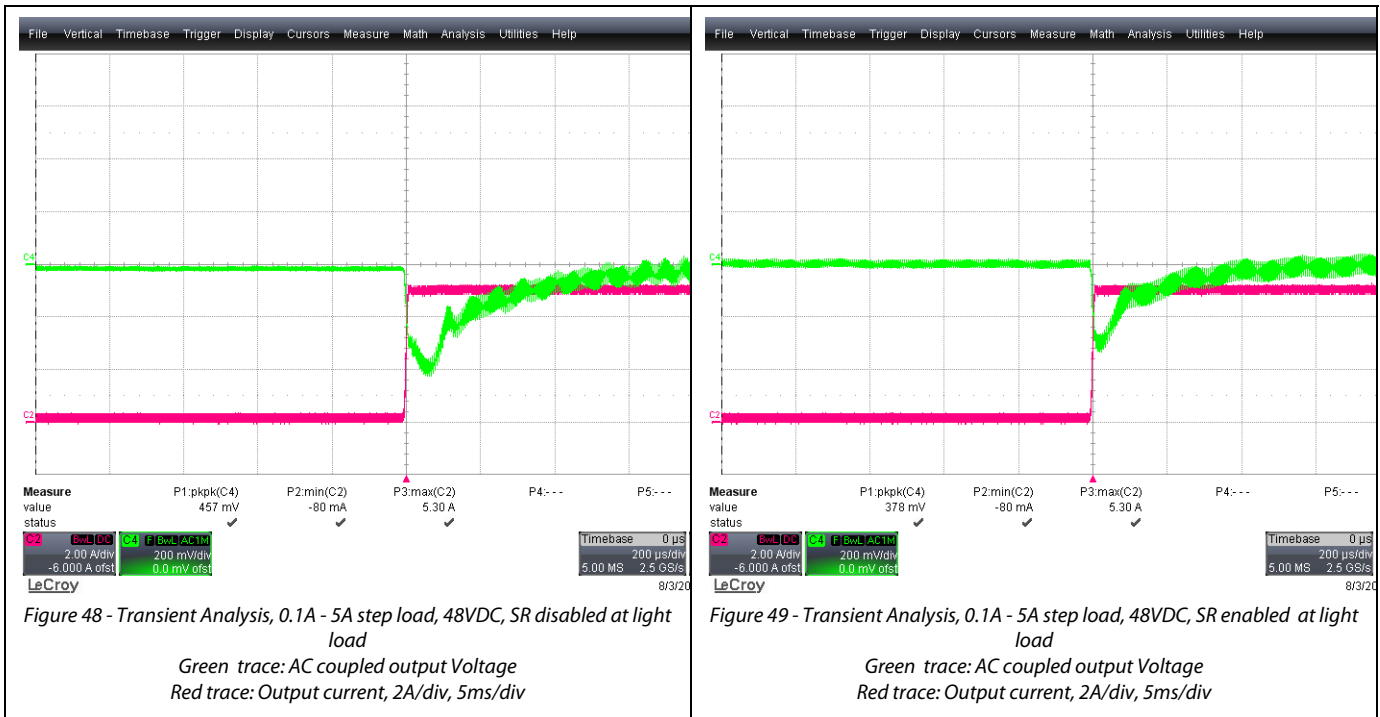


Figure 47 - Low frequency content of output voltage ripple at 8A load, 48VDC
Green trace: AC coupled output voltage

- C. **Transient Response under DCM/CCM transition:** Figure 48 shows the dynamic response of the system under a load step of 0.1-5A (slew rate 1A/ μ s). A low starting current is chosen so that the converter is forced to disable the synchronous rectifiers due to the light load threshold setting in the CS2 window. In contrast, Figure 49 shows the response with the light load threshold set at 0A (SR always on). This forces the output inductor current to be continuous and the converter remains in CCM despite the load condition drawing energy from the output capacitor to charge the inductor.



Additional things to try:

- Tweaking the light load transient response (0-500mA step load).
- Increasing the crossover frequency and measure transient response.
- Measuring transient response under different load steps.
- Increasing the phase margin to 60 degrees by cancelling the double pole of the output LC filter by the two zeros of the Type 3 compensation.
- Measuring the transient response (0.2A - 8A) by enabling the light load mode at 0.0A (SR always enabled) thus keeping the output inductor in CCM regardless of the load.
- Measuring the dynamic response at an increased switching frequency of 200KHz.

ORFET SETTINGS

The ADP1046A includes features such as hot swapping as well as protection against a reverse current from other PSUs connected on the same bus with the use of active ORing (OrFET). This window sets the turn on condition of the OrFET depending upon the voltage threshold across it as well as its turn off depending upon the reverse current flowing in the current sense resistor $CS2^- - CS2^+$. This enables hot swapping and allows additional PSUs to be connected to the same bus without any interruption with sufficient protection.

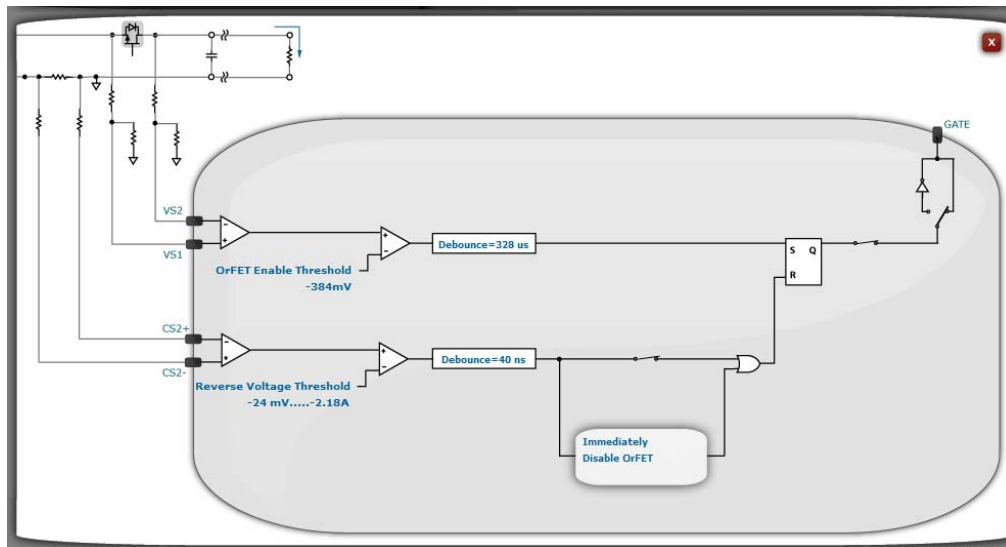
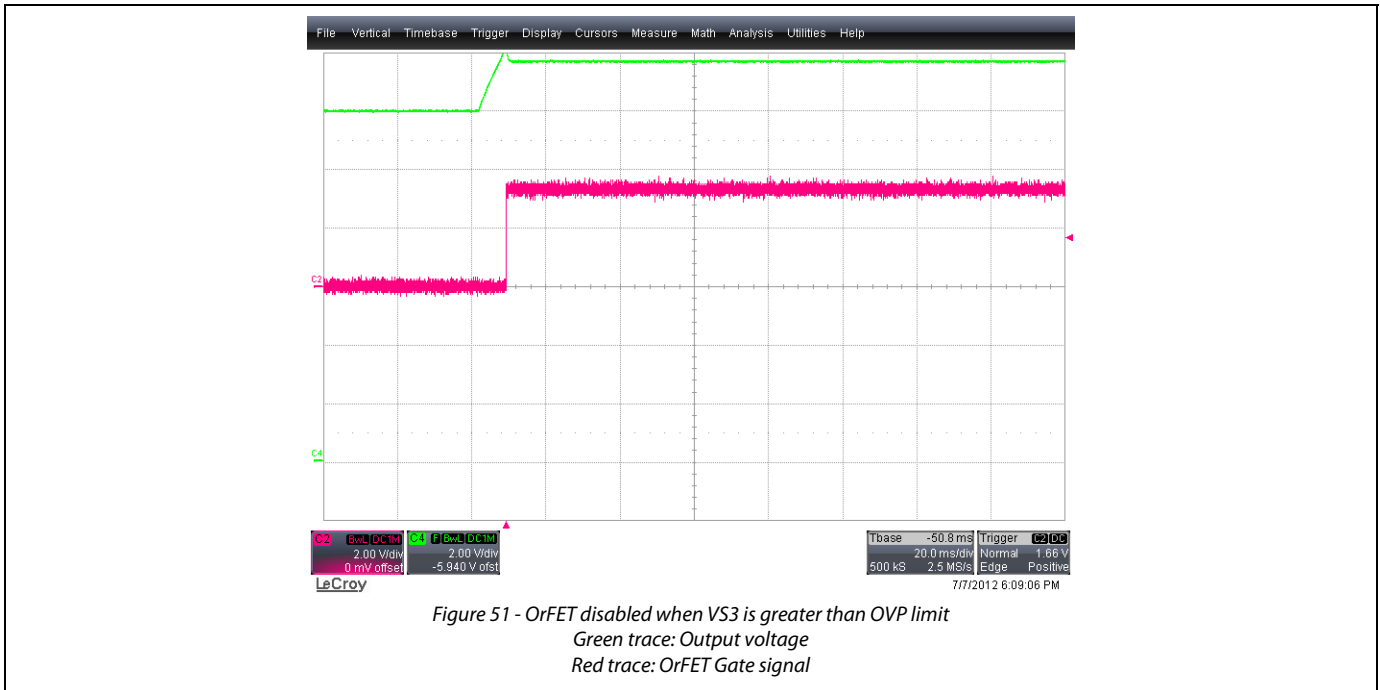


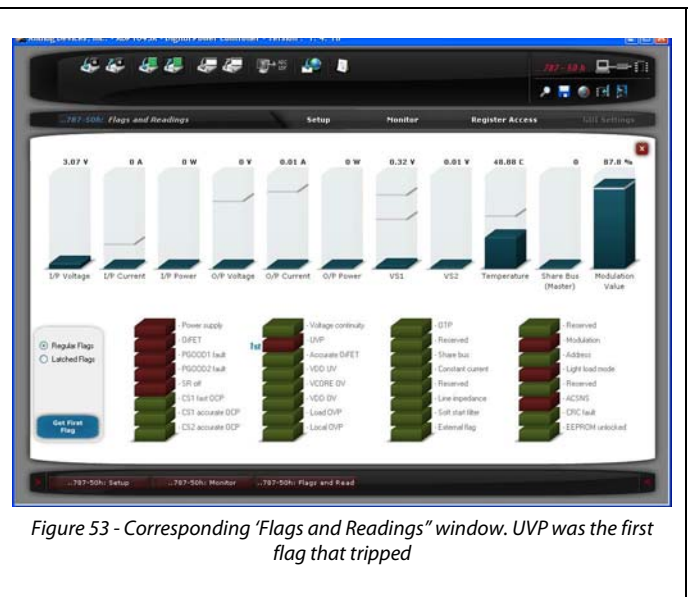
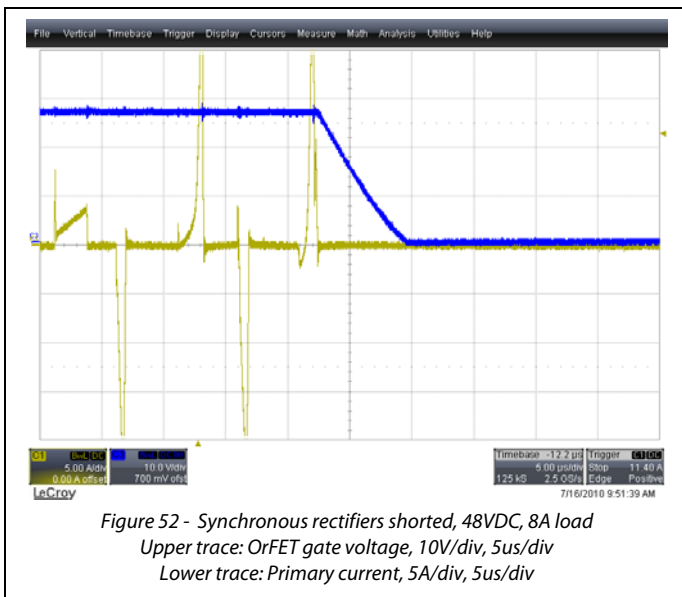
Figure 50 - OrFET Settings window

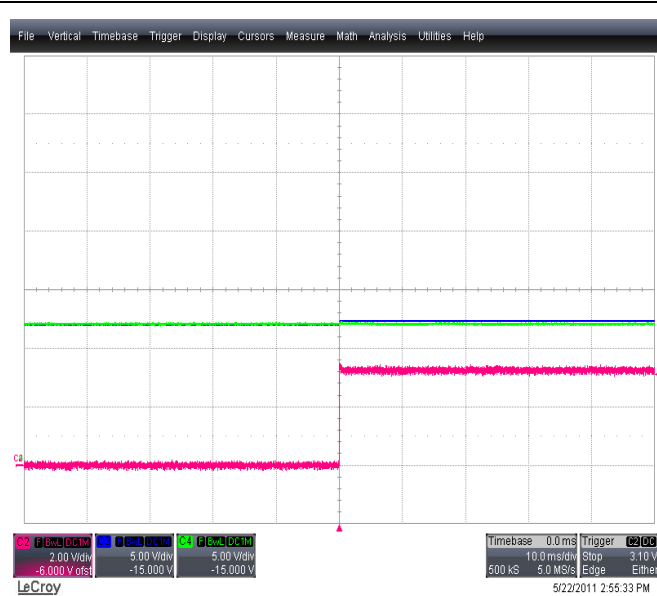
The following waveforms display some of the features that can be changed using this window.

- A. **Load OVP action on OrFET:** Figure 51 shows the OrFET being disabled when a bus voltage is greater than the local voltage. A DC power supply can be connected to the output terminals of the board (J4, J5). Care should be taken to ensure that the output voltage is not beyond the voltage rating of the output capacitor (C7) and the absolute maximum VCC rating of the SR driver (U1). Here the load OVP flag is used to protect the PSU by disabling the OrFET. The body diode of the MOSFET (Q1) is reversed biased during this condition.

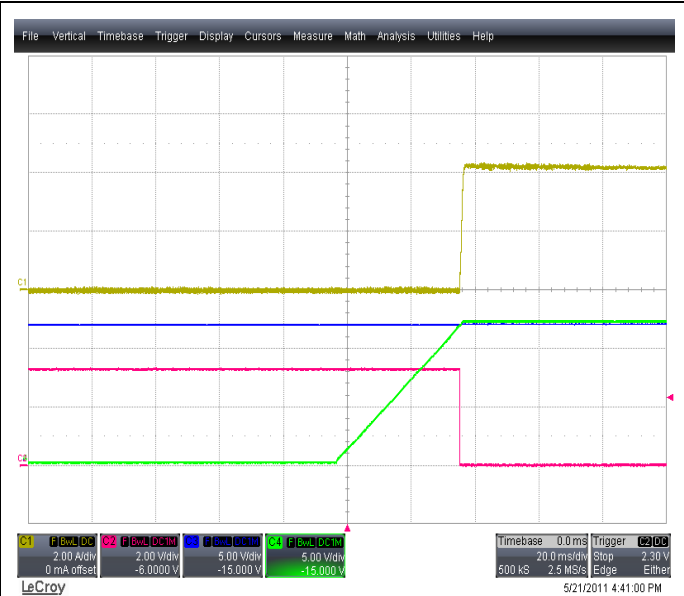


B. **Internal short circuit action on OrFET:** Figure 52 and Figure 53 shows the OrFET disabled during an internal short circuit and its corresponding flag. An internal short of the synchronous rectifiers can be simulated in the PWM settings or by physically shorting the drain pin of Q2 and Q3. The CS1 fast OCP or the UVP flags can be set to disable the OrFET.

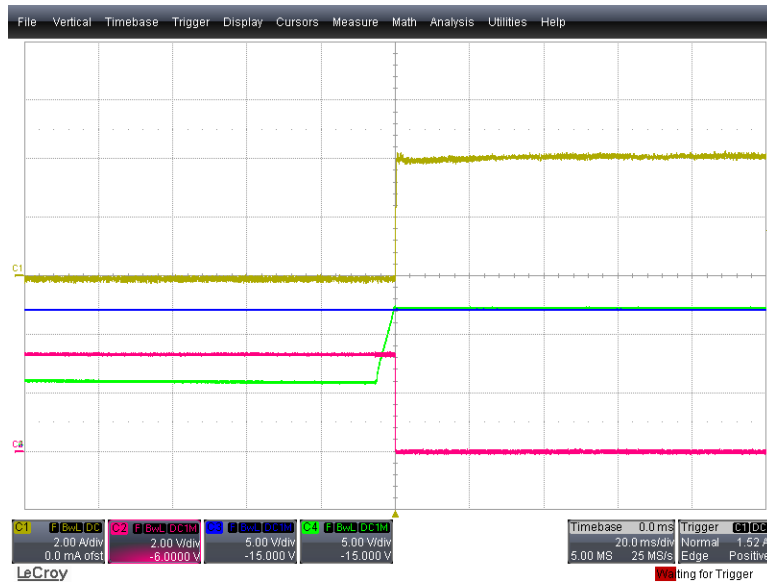




*Figure 54 – Runaway Master
Green trace: Bus 1 output voltage
Blue trace: Bus 2 whose output voltage flies up.
Red trace: Gate pin*



*Figure 55 – Softstart into live bus
Blue trace: Bus 1 output voltage
Green trace: Bus 2 output voltage
Yellow trace: Load current supplied by 2nd power supply
Red trace: Gate pin*



*Figure 56 – Softstart into live bus from precharge
Blue trace: Bus 1 output voltage
Green trace: Bus 2 output voltage
Yellow trace: Load current supplied by 2nd power supply
Red trace: Gate pin*

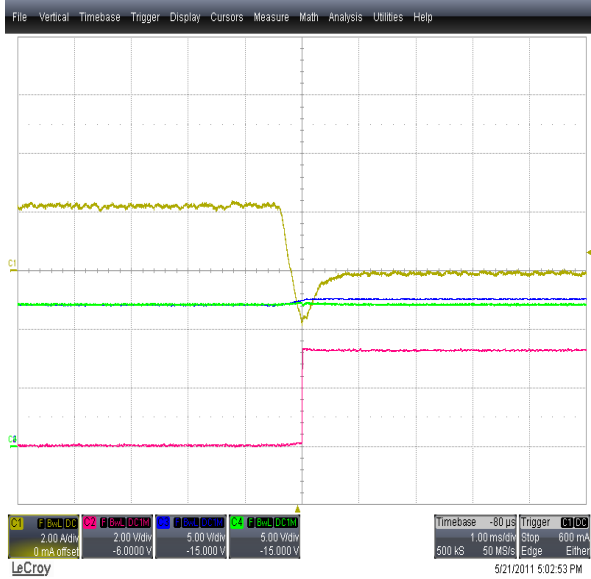


Figure 57 – Output reverse current protection, threshold 'A'
 Red trace: OrFET gate signal
 Green and Blue trace: Output voltages of two power supplies
 Yellow trace: Load current

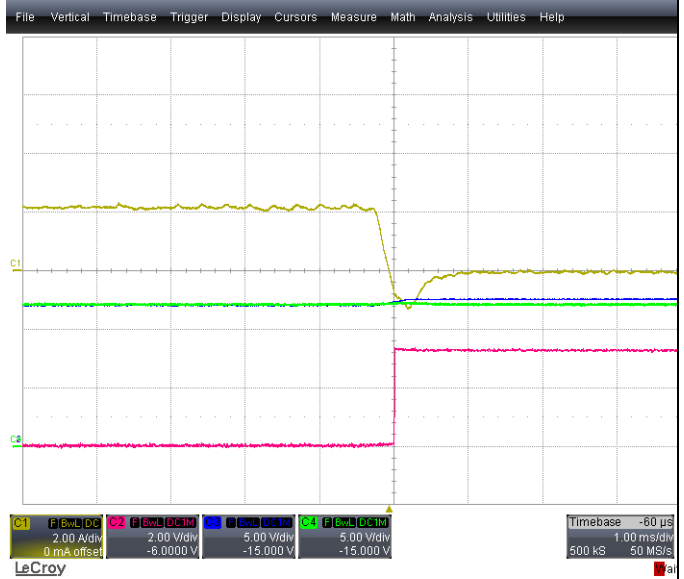


Figure 58 – Output reverse current protection, threshold 'B'
 Red trace: OrFET gate signal
 Green and Blue trace: Output voltages of two power supplies
 Yellow trace: Load current



Figure 59 – Output reverse current protection, OrFET enable threshold -384mV
 Red trace: OrFET gate signal
 Green and Blue trace: Output voltages of two power supplies
 Yellow trace: Load current of power supply that is softstarting

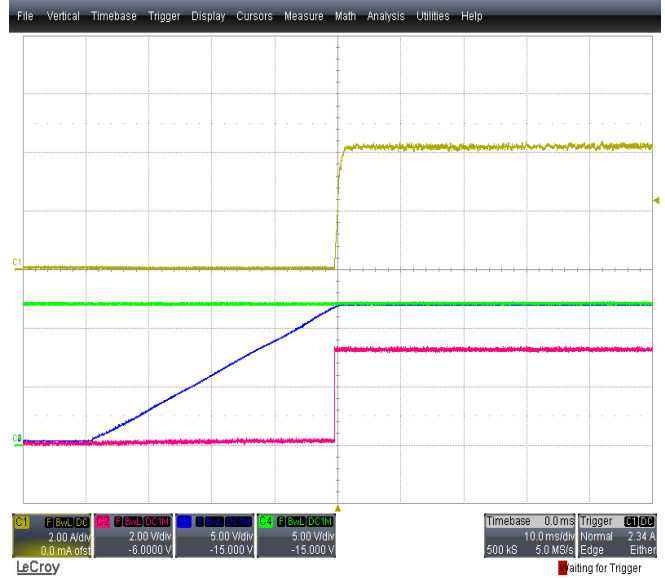


Figure 60 – Output reverse current protection, OrFET enable threshold 0mV
 Red trace: OrFET gate signal
 Green and Blue trace: Output voltages of two power supplies
 Yellow trace: Load current of power supply that is softstarting

Additional things to try:

- Disable OrFET using CS1 OCP, Load UVP or fast OrFET when an internal short circuit occurs.
- Disable OrFET using VS3 when $V_{OUT} > OVP$ limit.
- Disable ORFET using ACSNS in light load mode to minimize light load standby consumption.

FULL BRIDGE PHASE SHIFTED MODE

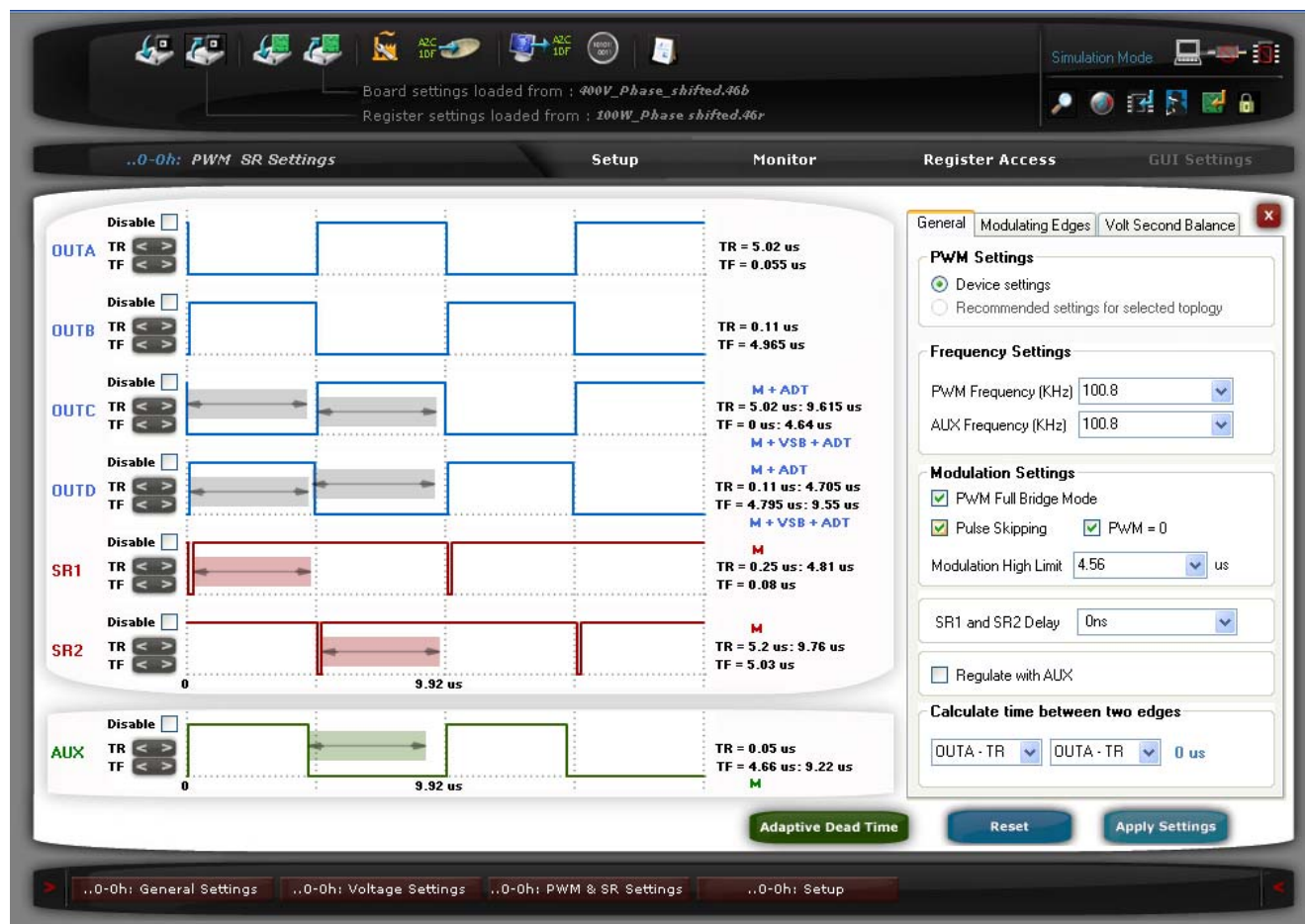


Figure 61 - PWM Settings for Full Bridge Phase Shifted Mode

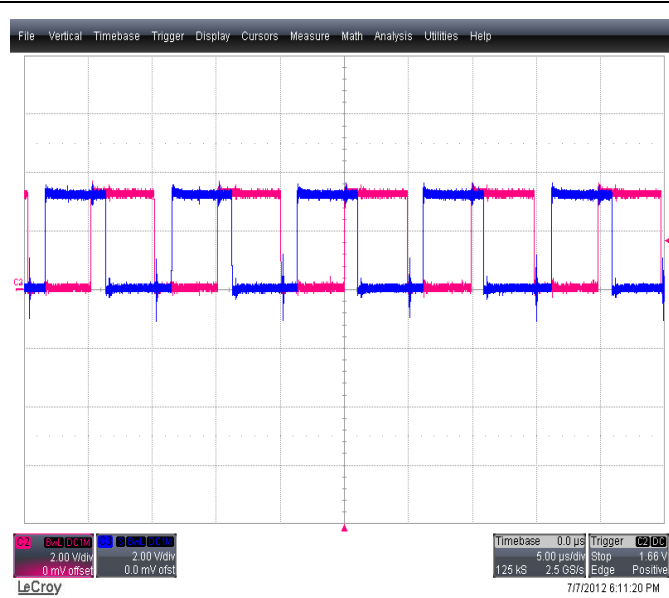


Figure 62 - Effective duty cycle 48V, light load
Red and blue traces: OUTA and OUTD

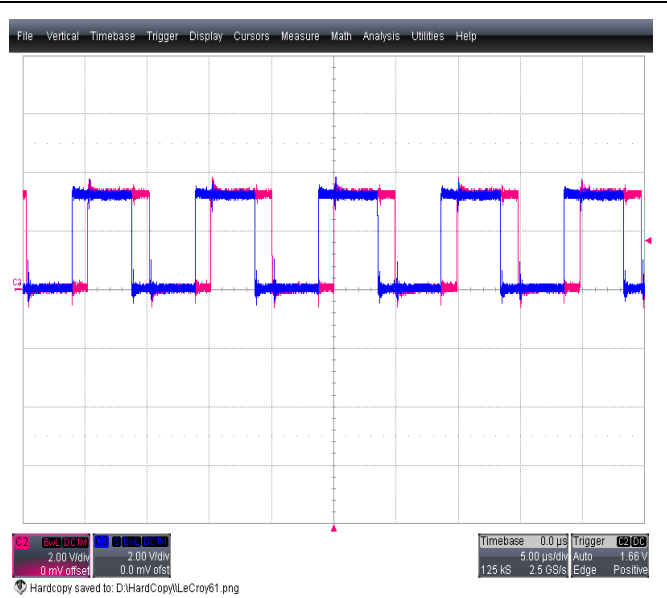


Figure 63 - Effective duty cycle 48V, full load
Red and blue traces: OUTA and OUTD

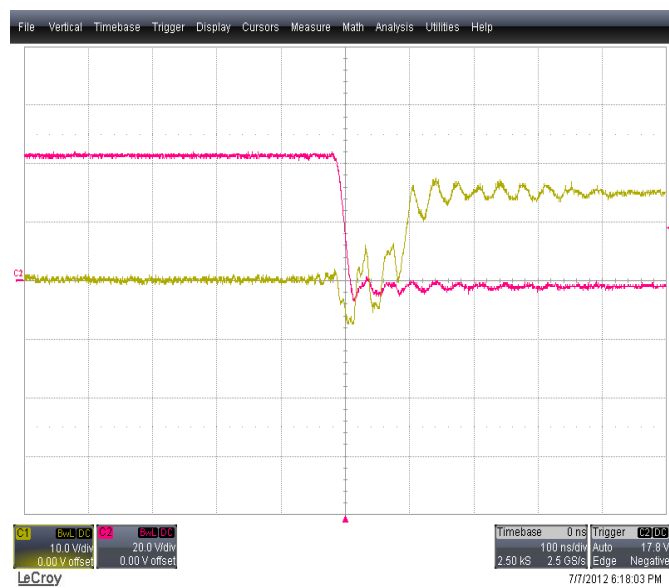


Figure 64 - ZVS turn on of QD transistor
Red trace: OUTD

Red trace: Drain – Source voltage of QD transistor

NOTE: An additional 1μH inductor needs to be connected in series with the primary winding

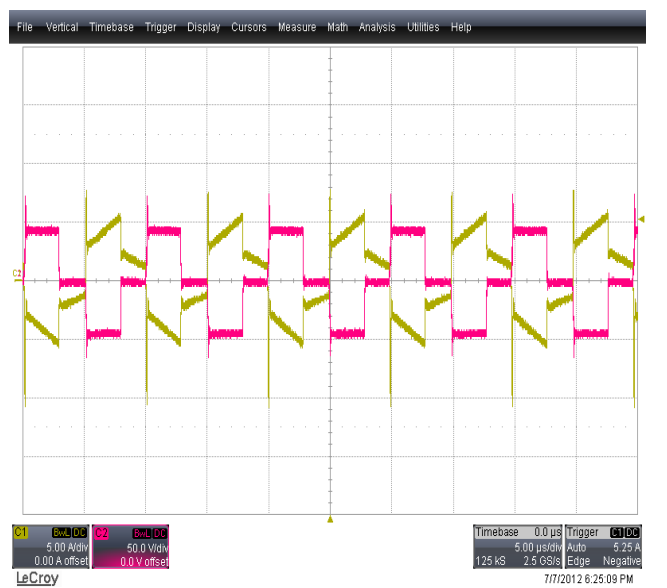
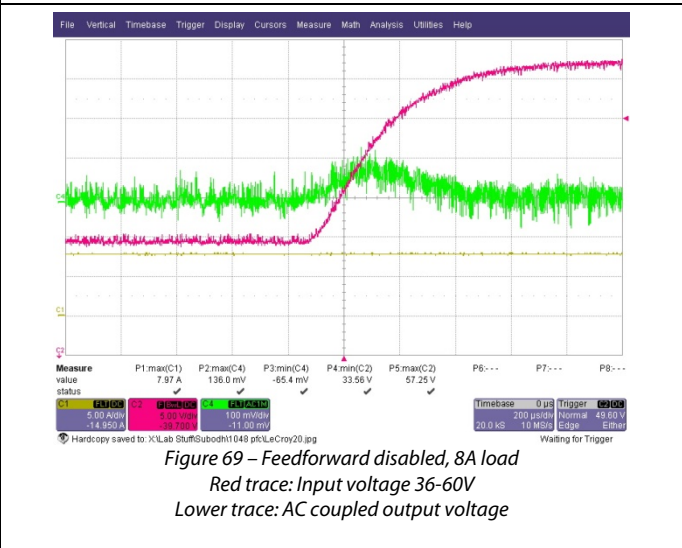
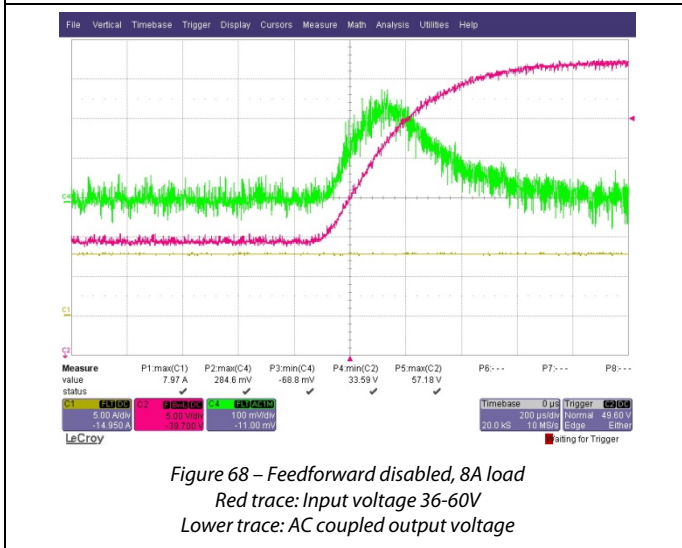
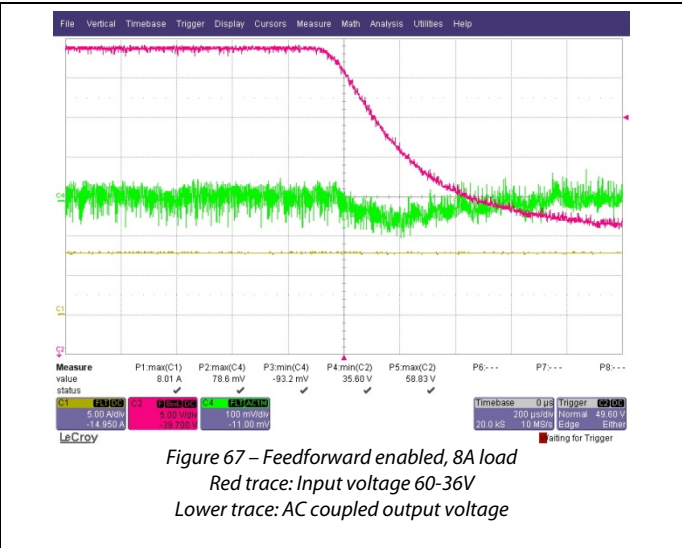
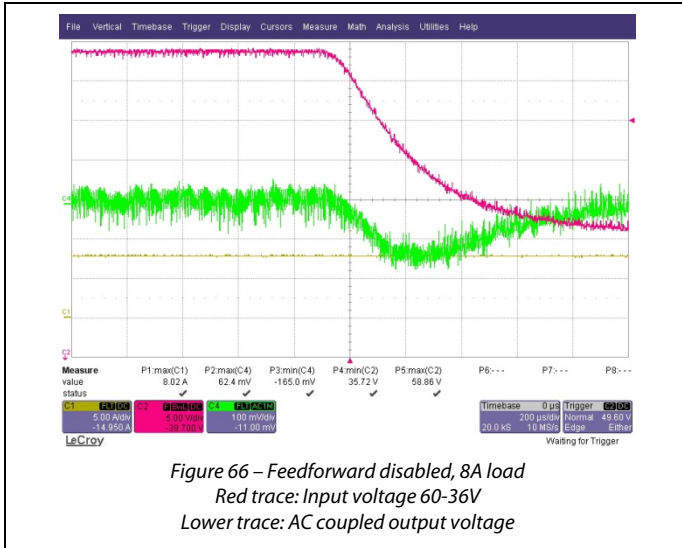


Figure 65 - 48VDC, full load

Red trace: Transformer primary winding voltage
Yellow trace: Primary current

LINE VOLTAGE FEEDFORWARD



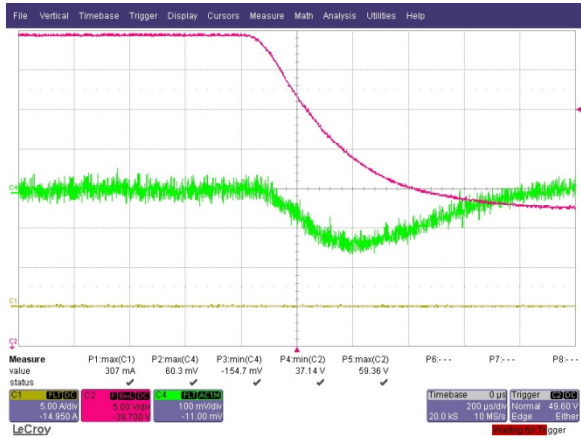


Figure 70 – Feedforward disabled, 0A load
Red trace: Input voltage 60-36V
Lower trace: AC coupled output voltage

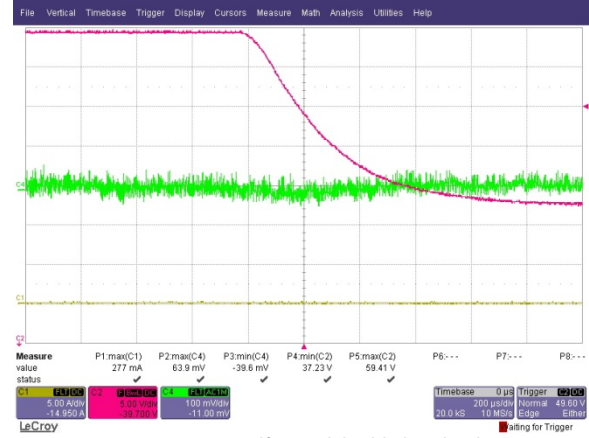


Figure 71 – Feedforward disabled, 0A load
Red trace: Input voltage 60-36V
Lower trace: AC coupled output voltage

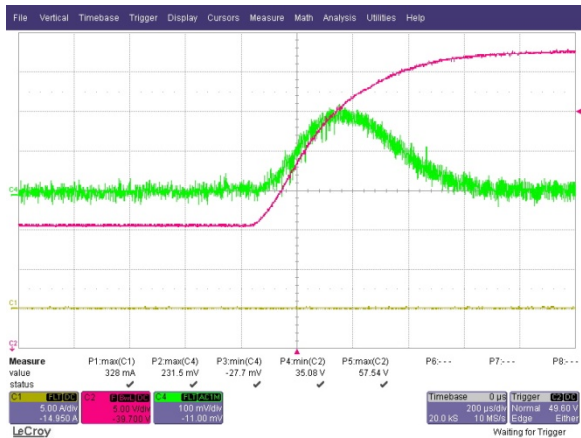


Figure 72 – Feedforward disabled, 0A load
Red trace: Input voltage 36-60V
Lower trace: AC coupled output voltage

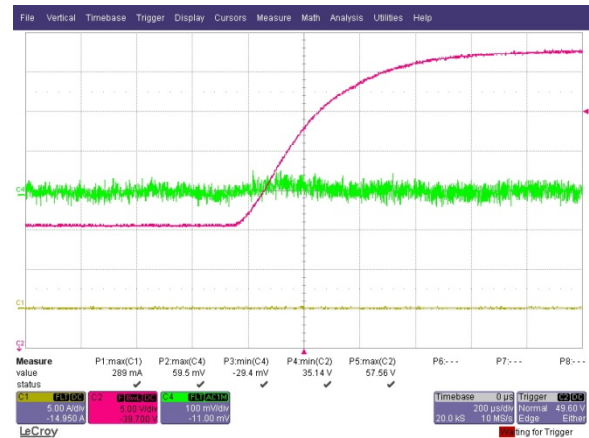


Figure 73 – Feedforward disabled, 0A load
Red trace: Input voltage 36-60V
Lower trace: AC coupled output voltage

APPENDIX I – SCHEMATIC (MAIN BOARD)

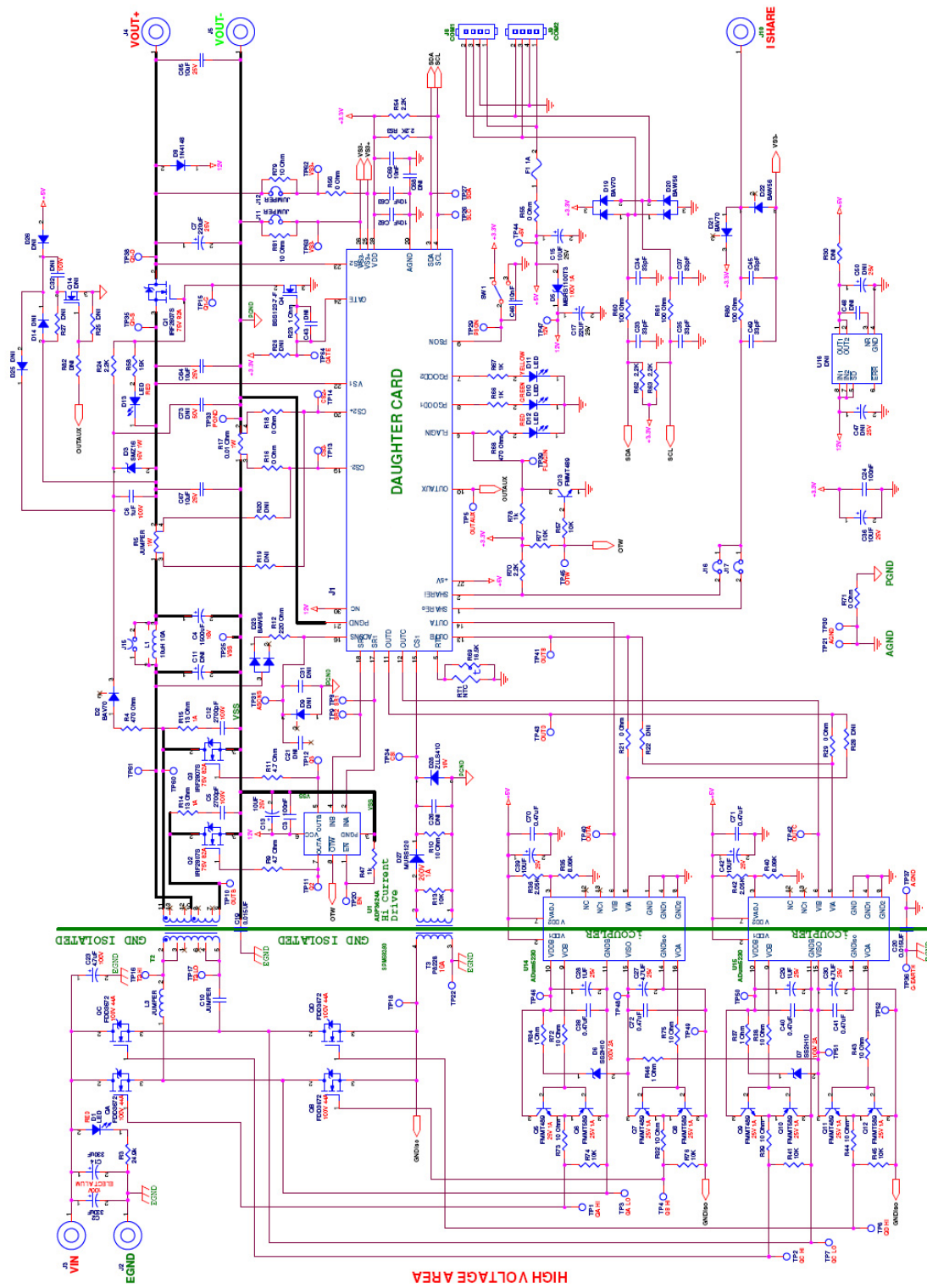


Figure 74 – Main board schematic

APPENDIX II – SCHEMATIC (DAUGHTER CARD)

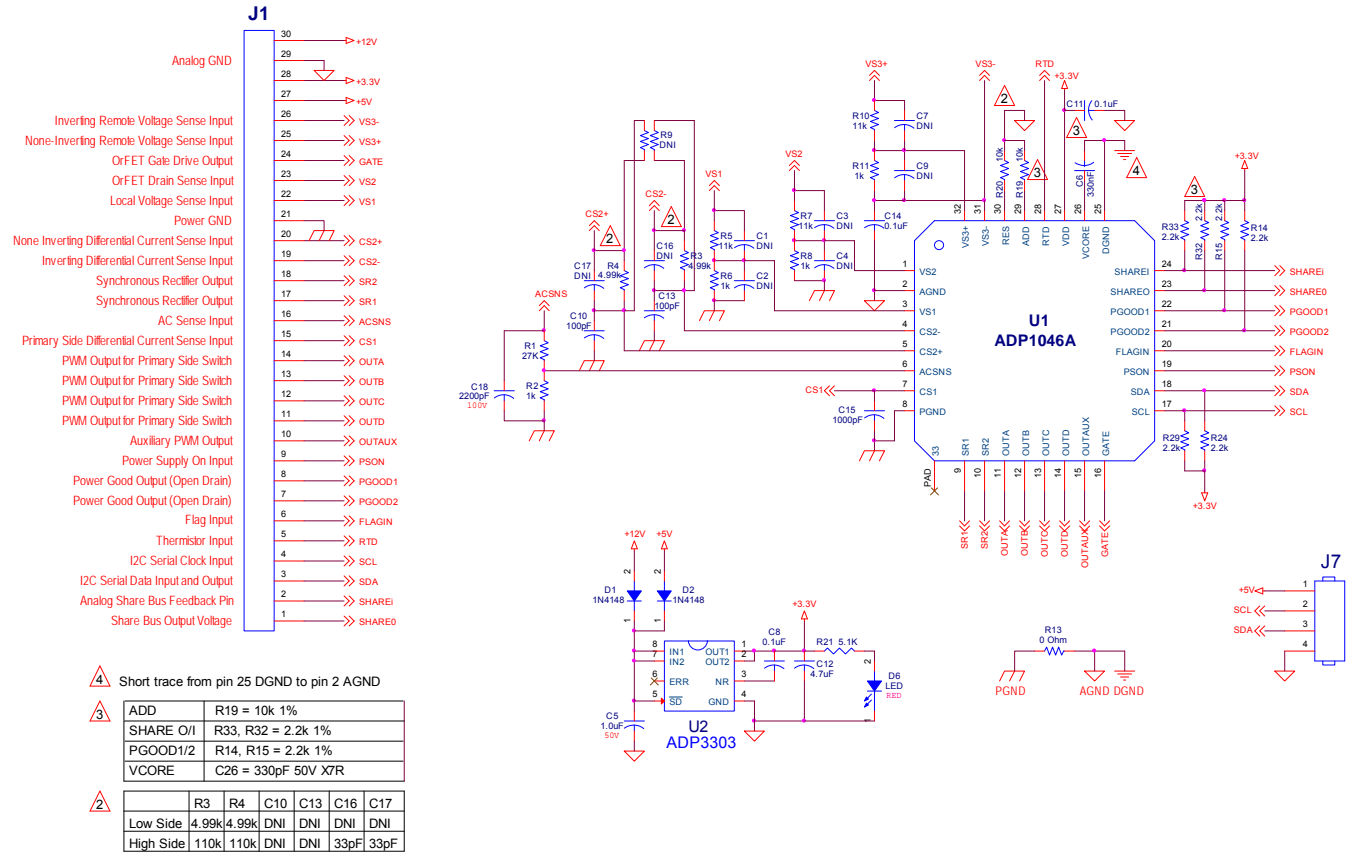


Figure 75 – Daughter card schematic

APPENDIX III – LAYOUT (MAIN BOARD)

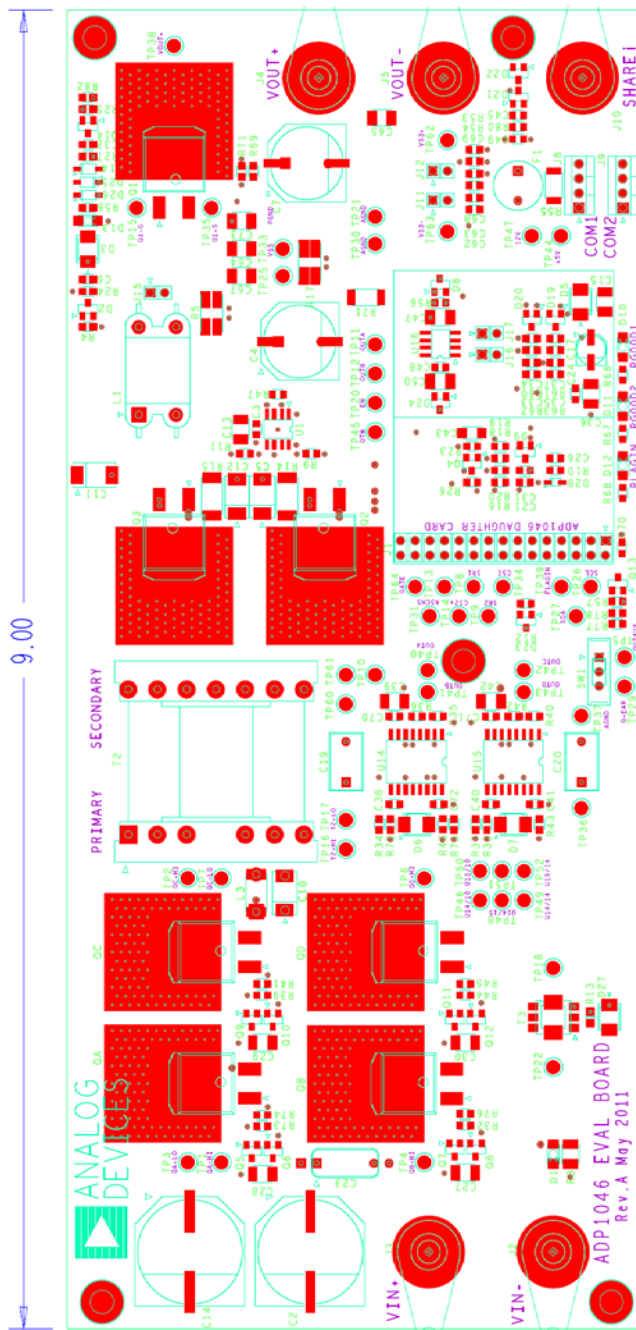


Figure 76 – Layout, Silkscreen layer, dimensions in inches

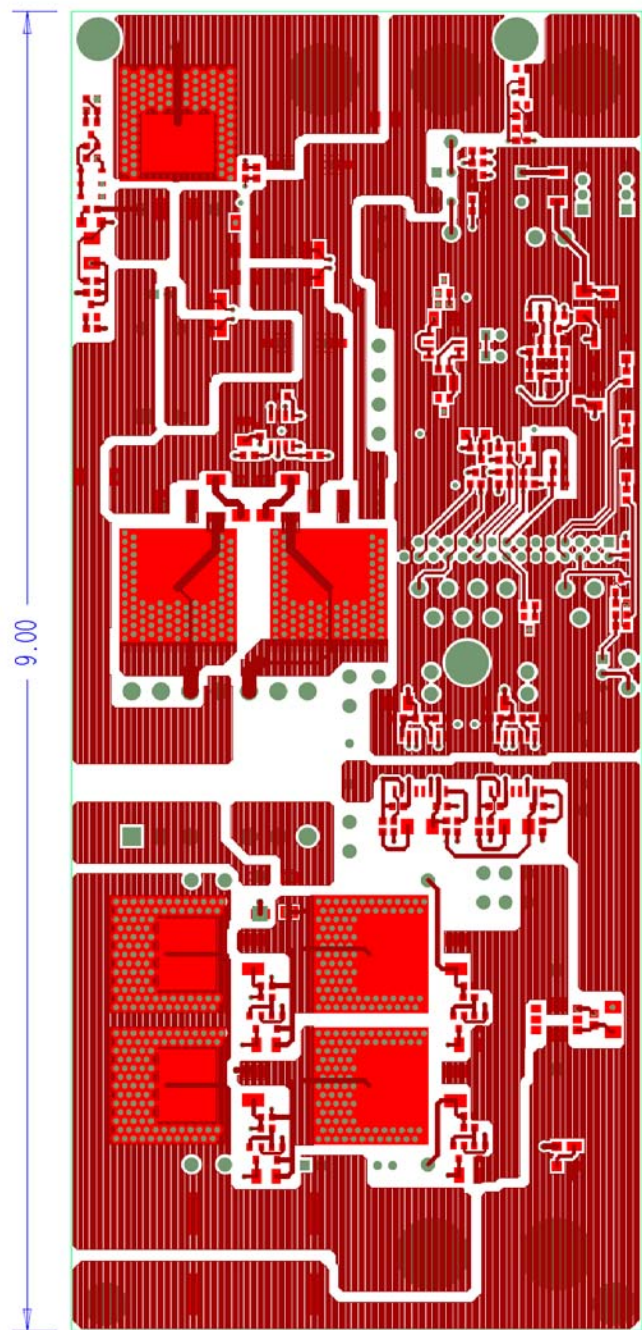


Figure 77 - Layout, Top layer, dimensions in inches

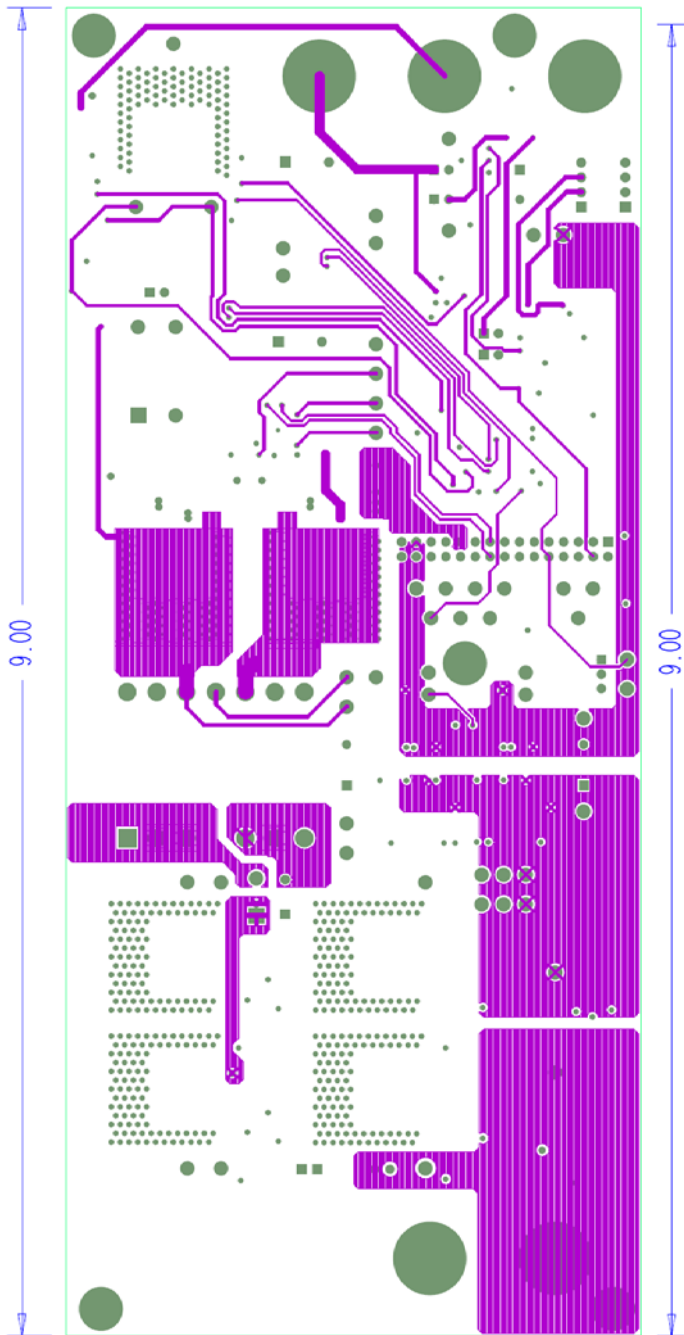


Figure 78 - Layout, inner layer 1, dimensions in inches

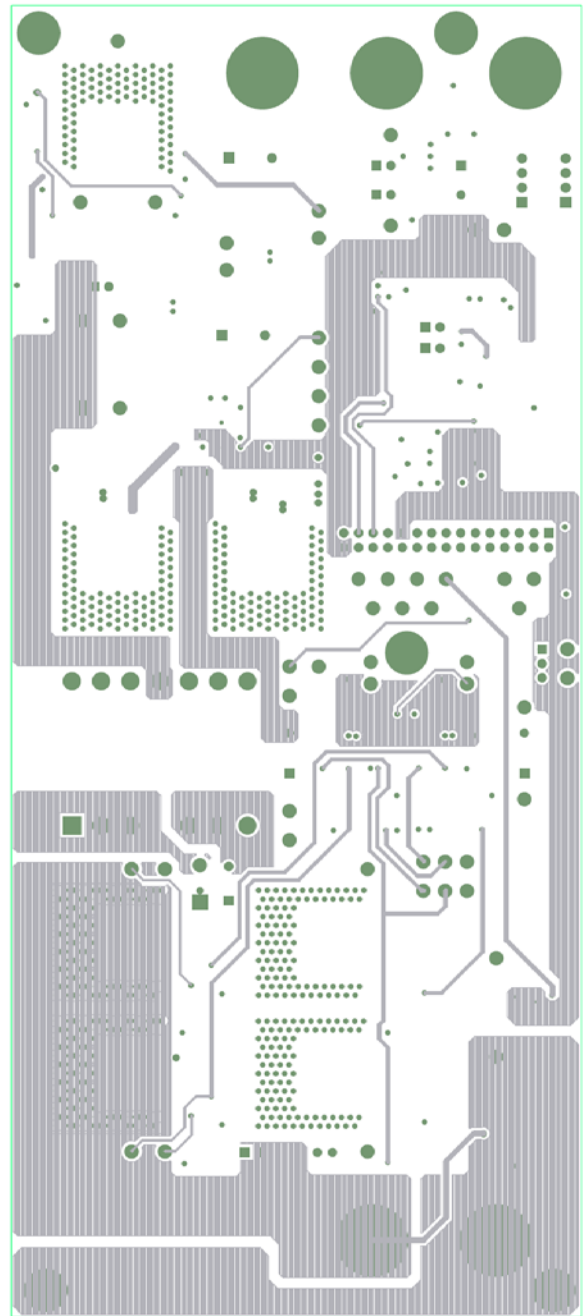


Figure 79 - Layout, inner layer 2, dimensions in inches

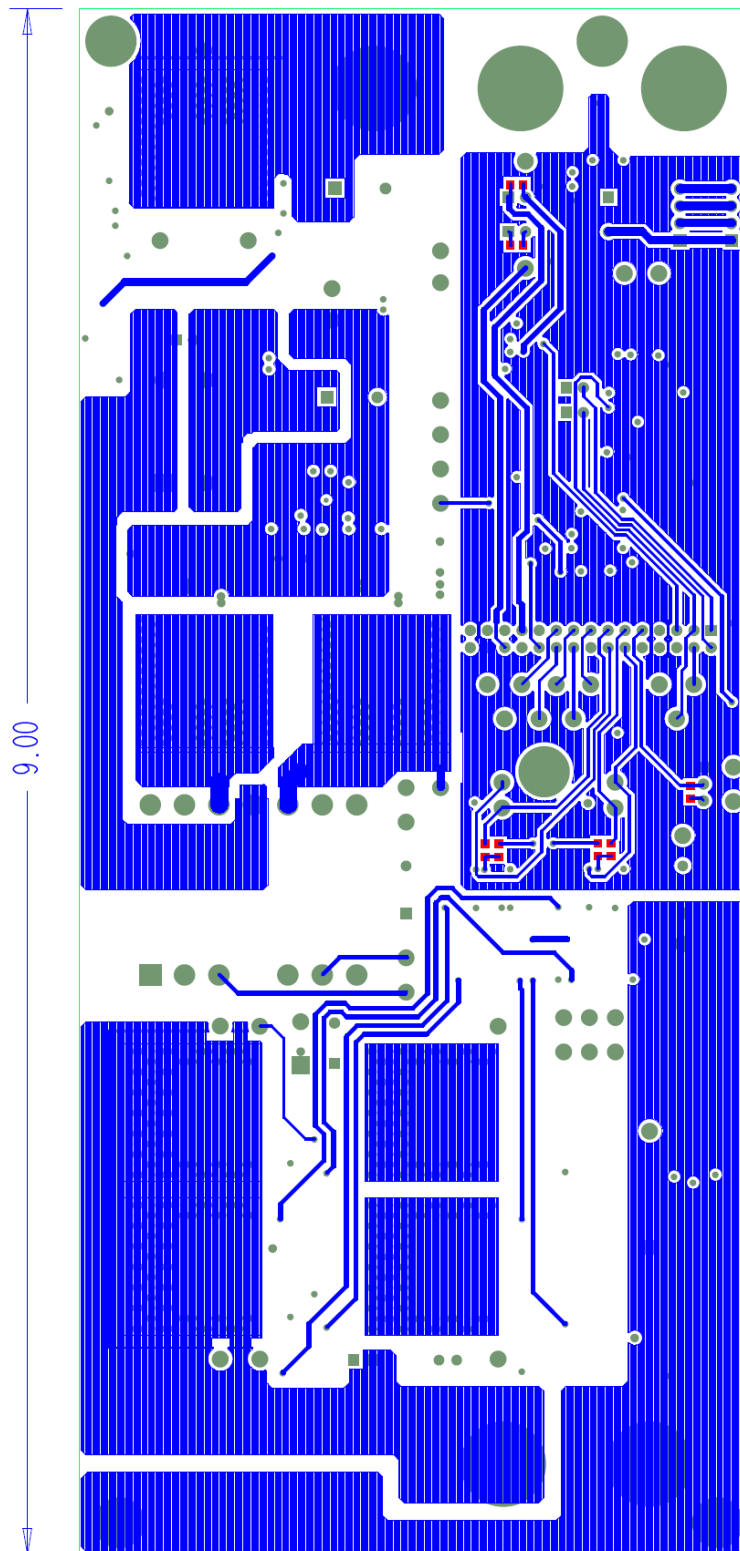


Figure 80 - Layout, bottom layer, dimensions in inches

APPENDIX IV – LAYOUT (DAUGHTER CARD)

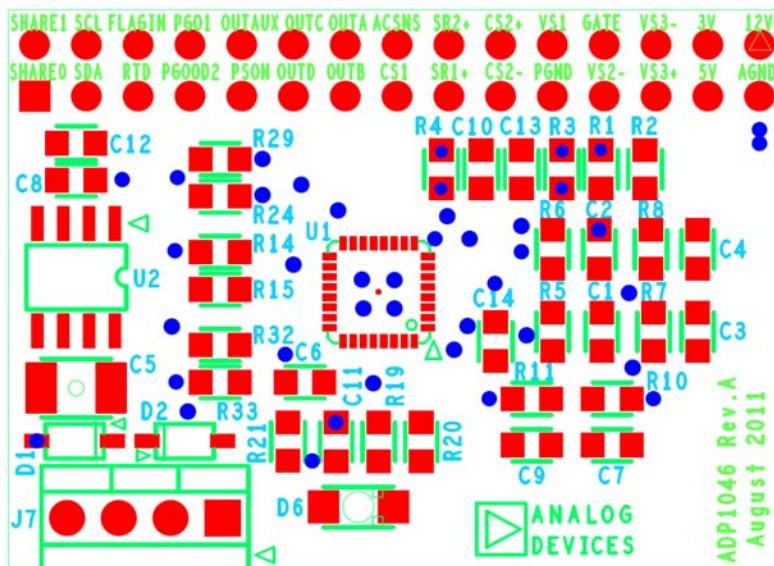


Figure 81 - Top Layer

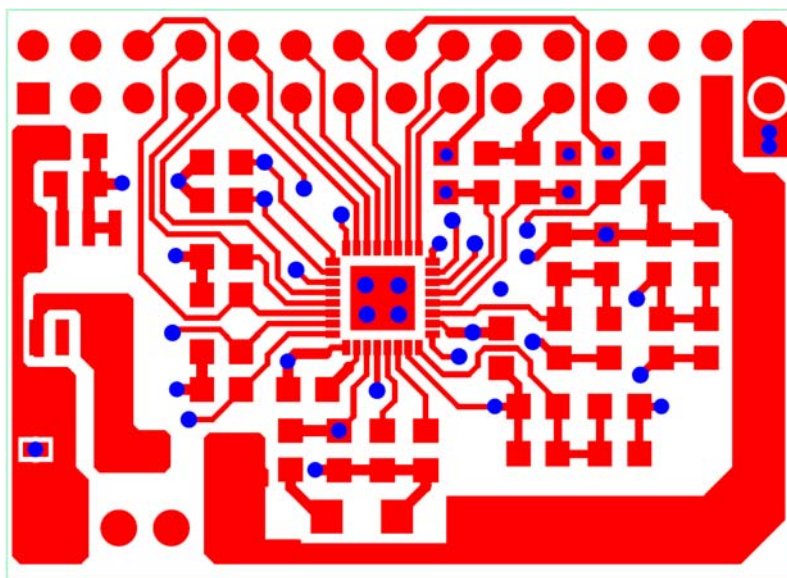


Figure 82 – Layer 1

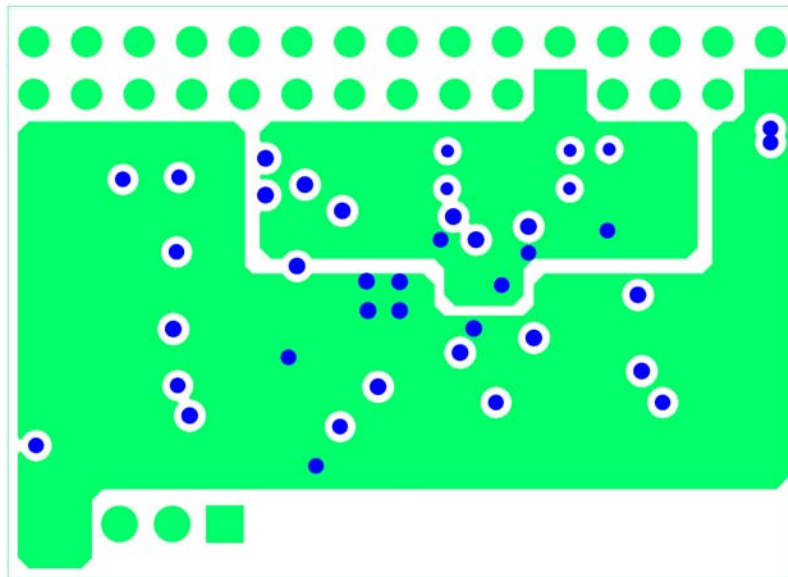


Figure 83 - Layer 2

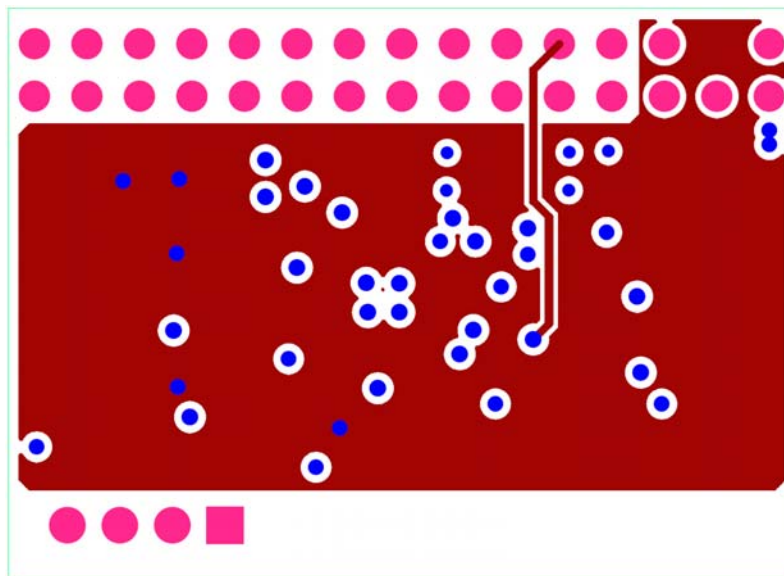


Figure 84 - Layer 3

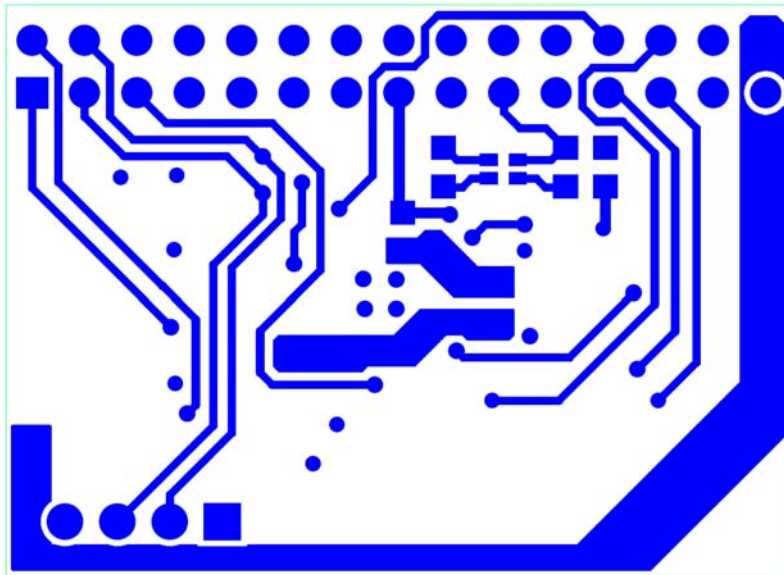


Figure 85 – Layer 4

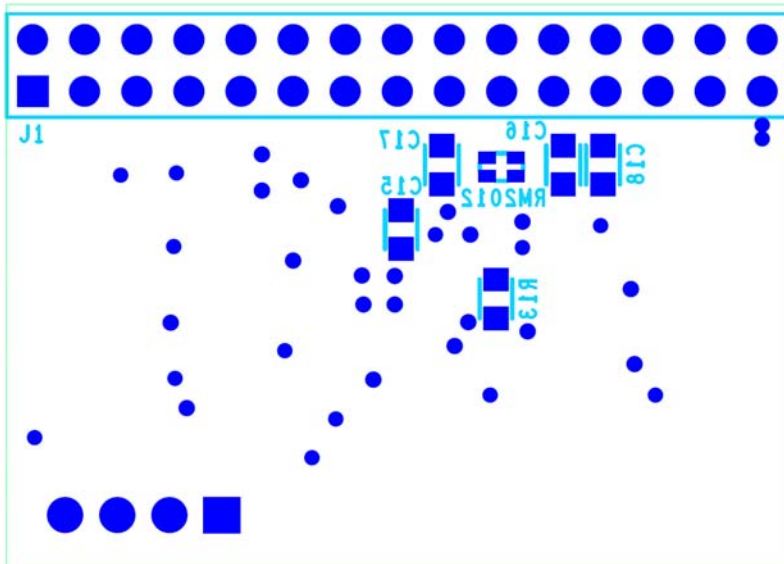


Figure 86 – Bottom layer

APPENDIX V - TRANSFORMER SPECIFICATION

PARAMETER	MIN	TYP	MAX	UNITS	NOTES
Core and Bobbin					ETD 29 Horizontal, 3F3 or equivalent
Primary inductance	77			μH	Pins 2,3 to pin 4,5
Leakage inductance		2.31	3	μH	Pins 2,3 to pin 4,5 with all other windings shorted
Magnetizing current		1.58		A	
Resonant frequency	850			KHz	Pins 2,3 to pin 4,5 with all other windings open

Table 5 - Transformer specifications

PARAMETER	MIN	TYP	MAX	UNITS	NOTES
Core					0077720A7, KoolMu, Magnetics Inc.
Pearmeability (μ_0)	75				
Inductance	6.5	10		μH	
DC resistance			6	mΩ	

Table 6 - Output Inductor specifications

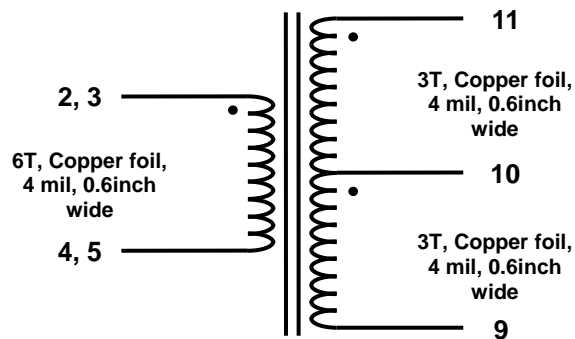


Figure 87 - Transformer electrical diagram

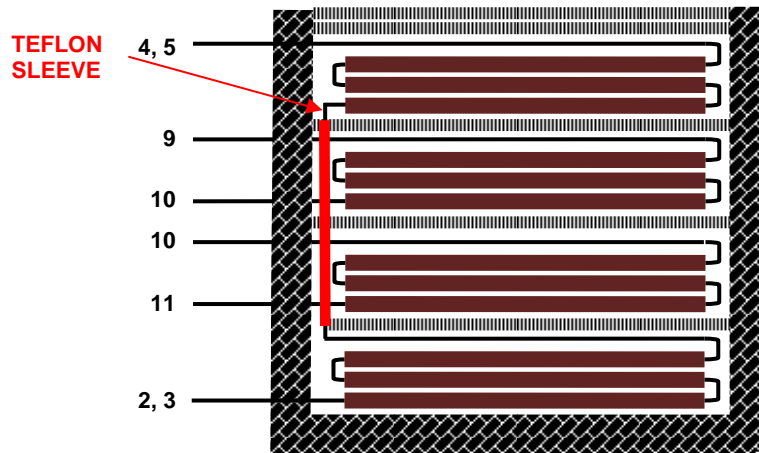


Figure 88 - Transformer construction diagram

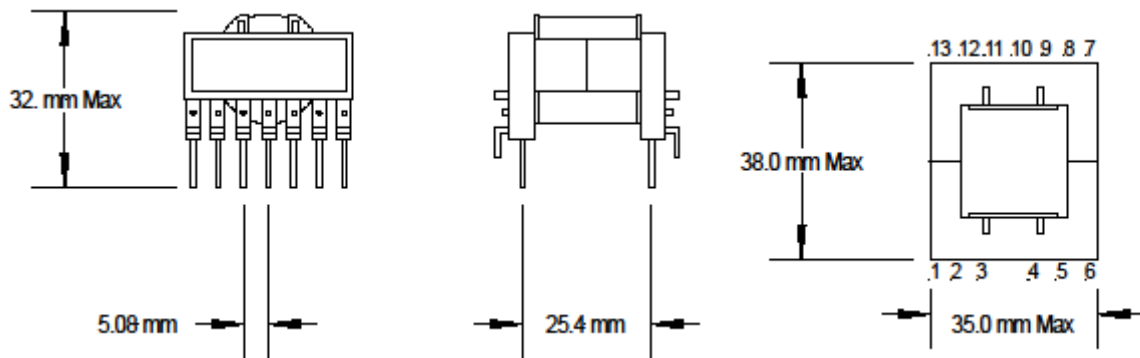


Figure 89 - Transformer Bobbin diagram

APPENDIX VI - OUTPUT INDUCTOR SPECIFICATION

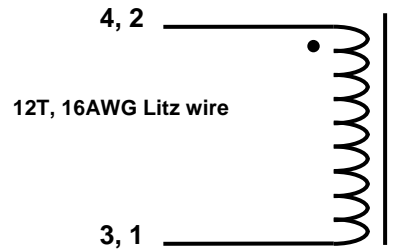


Figure 90 - Output inductor electrical diagram

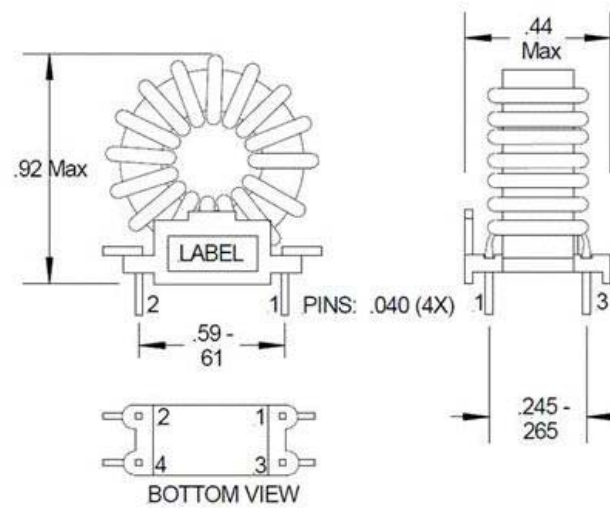


Figure 91 - Output inductor construction diagram

APPENDIX VII - THERMAL PERFORMANCE

All thermal tests were conducted at room temperature with no air flow with a load of 8A. A pre-soaking time of one hour was before collecting any data. An infrared thermal camera was used for the measurement.

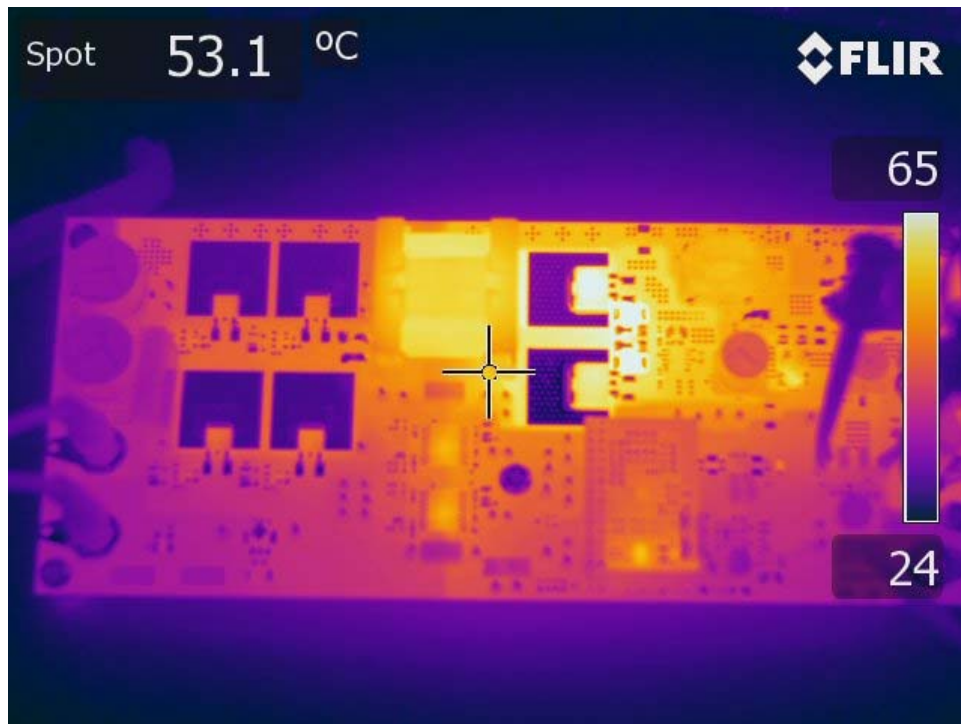


Figure 92 – Thermal image at 36 VDC, 8A load, no air flow, 1 hour soaking time.

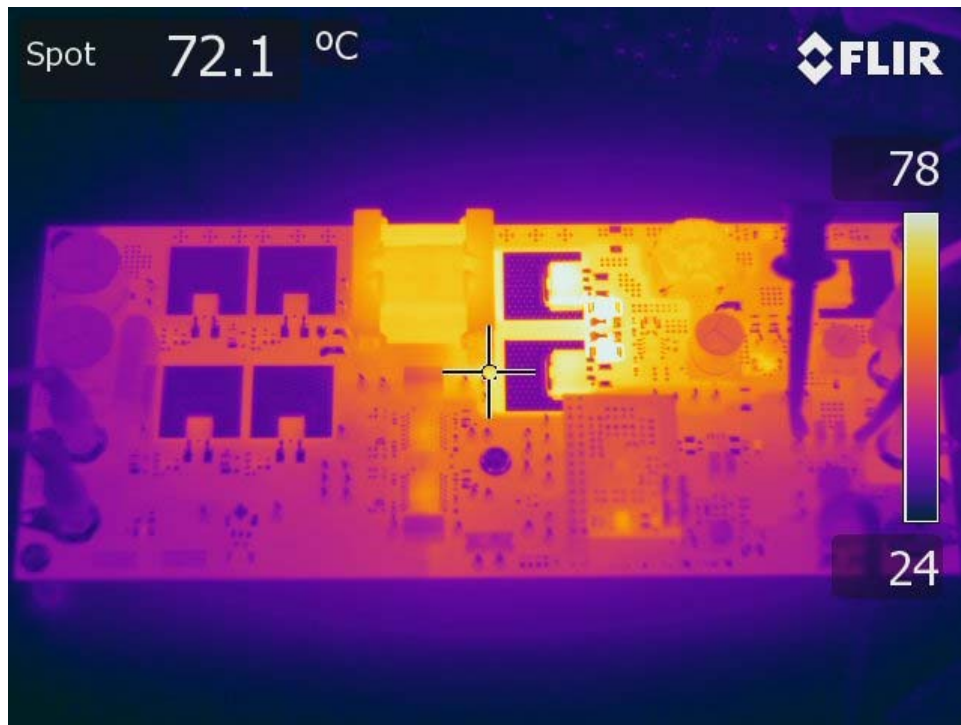


Figure 93 – Thermal image at 48 VDC, 8A load, no air flow, 1 hour soaking time.



Figure 94 – Thermal image at 60 VDC, 8A load, no air flow, 1 hour soaking time.

APPENDIX VIII – EFFICIENCY AND VOLTAGE REGULATION

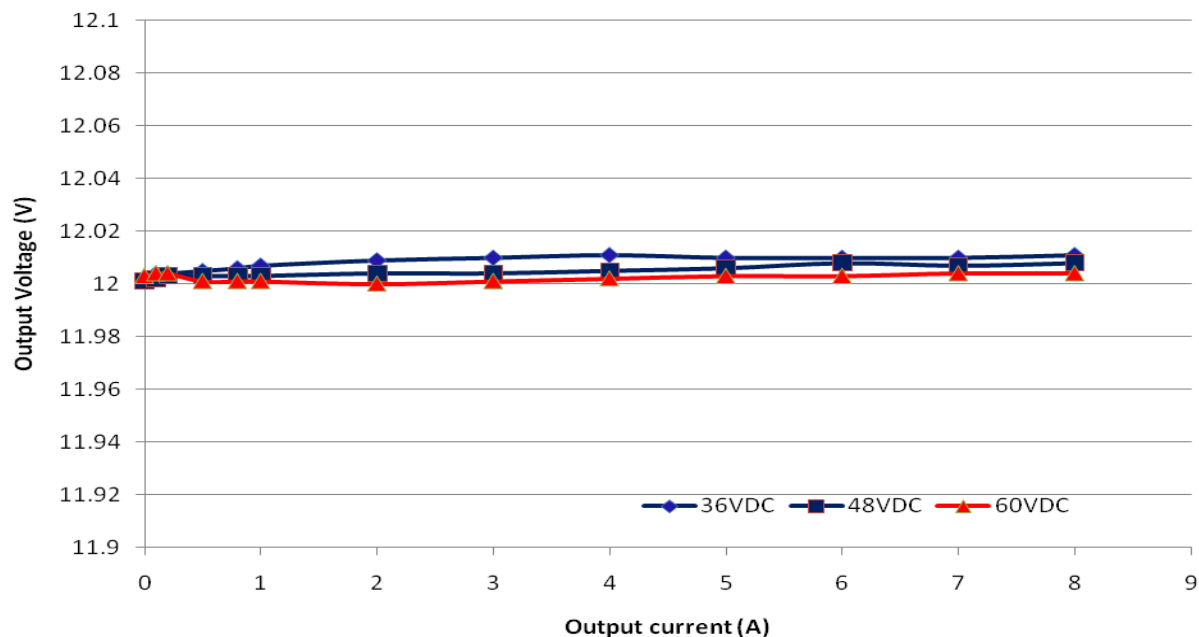


Figure 95 - Output voltage regulation vs load current

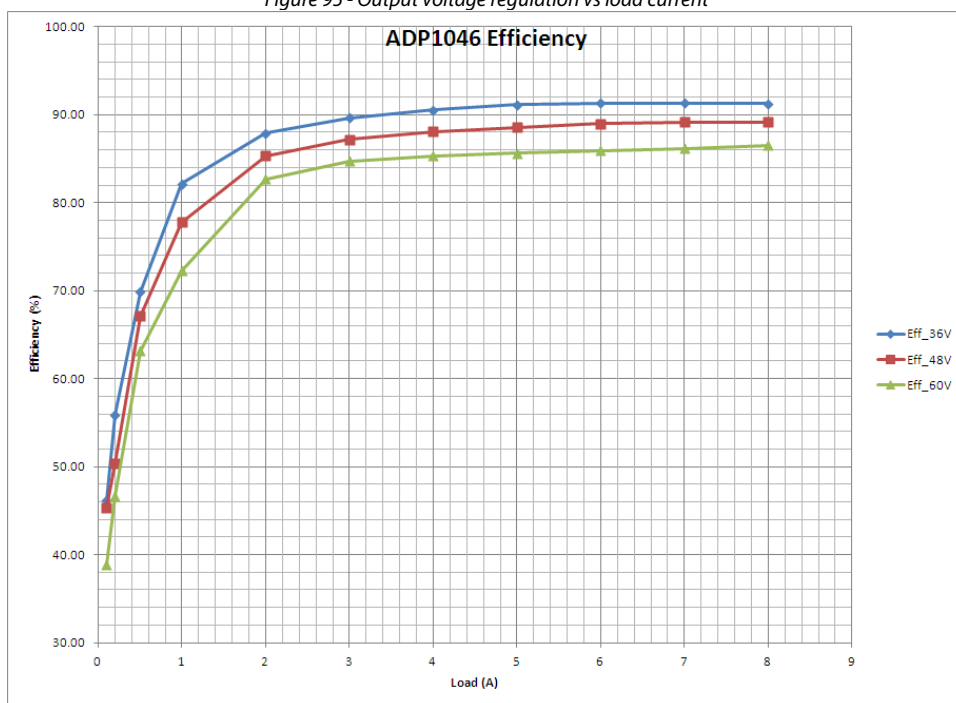


Figure 96 - Load current vs efficiency

APPENDIX IX – CS1 AND CS2 MEASUREMENT VS GUI READING

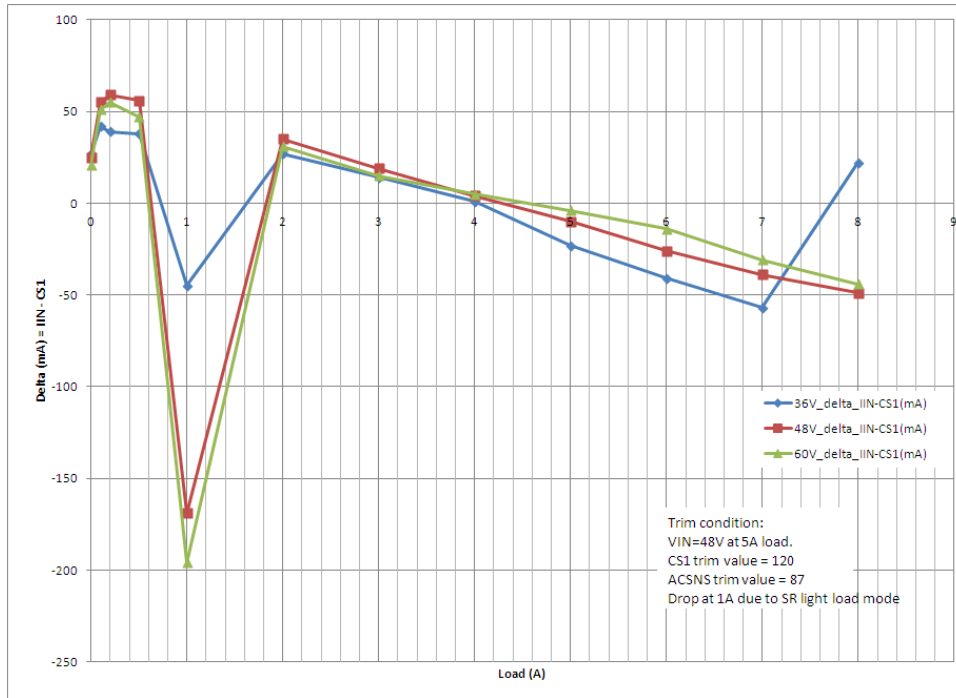


Figure 97 - Input current reading linearity

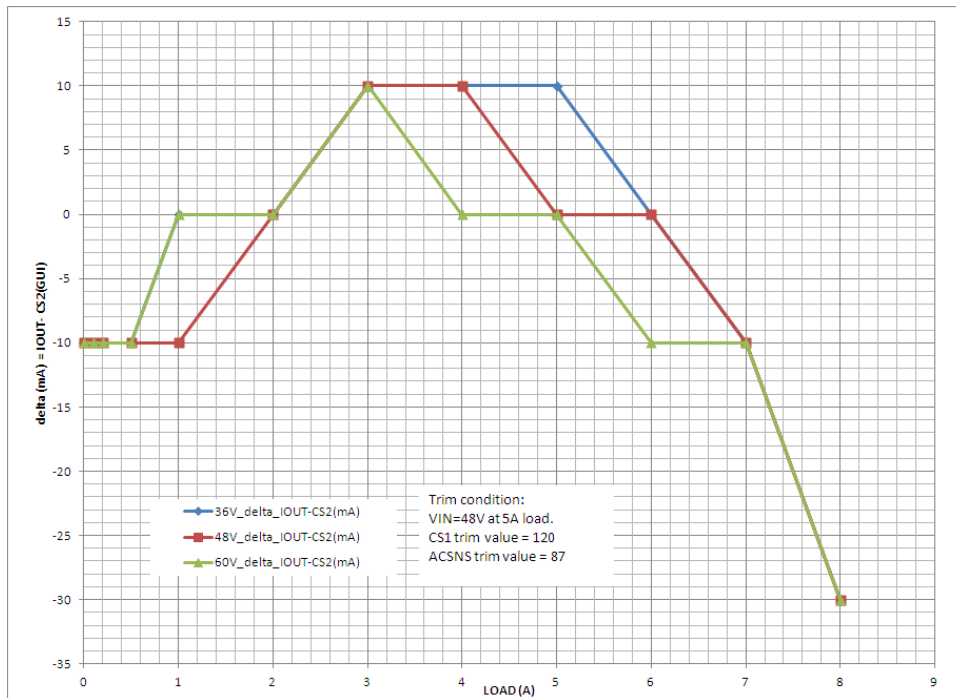


Figure 98 - Output current reading linearity

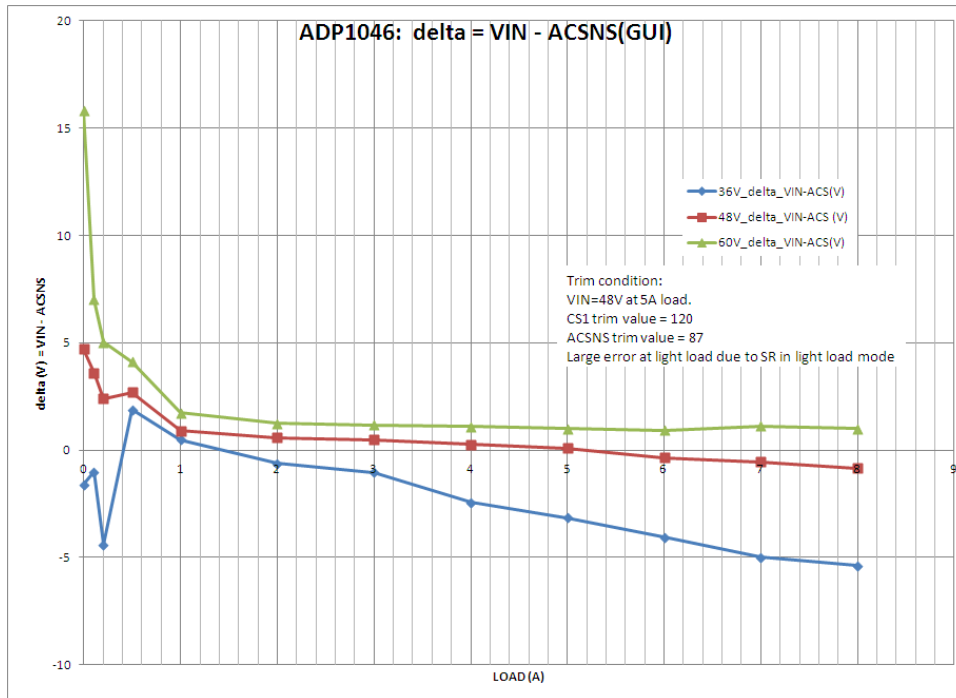


Figure 99 – ACSNS reading linearity

NOTES

