

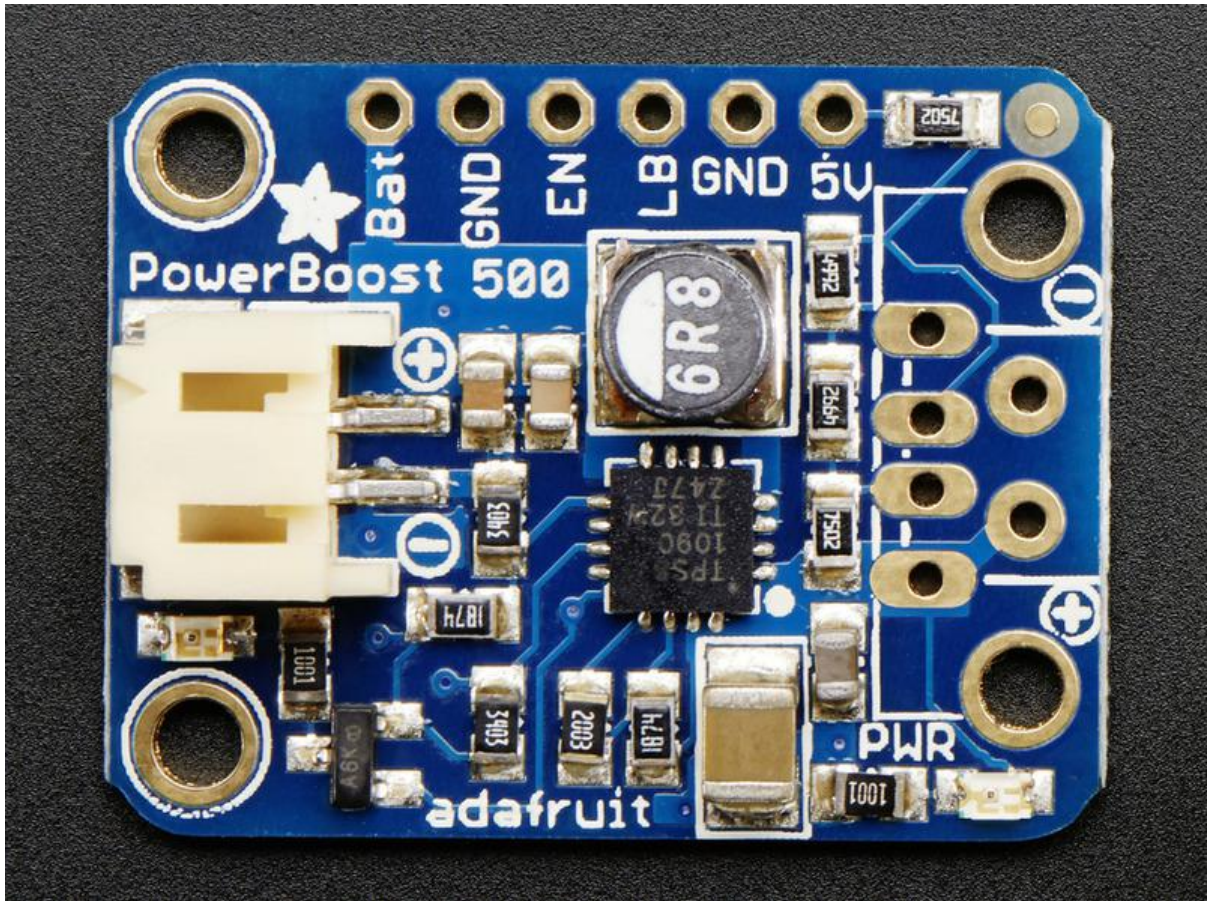

Adafruit PowerBoost 500 Basic

Created by lady ada



<https://learn.adafruit.com/adafruit-powerboost>

Last updated on 2023-08-29 02:33:02 PM EDT

Table of Contents

Overview	3
<hr/>	
Pinouts	5
<hr/>	
<ul style="list-style-type: none">• Power Pins• Control Pins• LEDs• Battery and USB connection	
Downloads	8
<hr/>	
<ul style="list-style-type: none">• Datasheets & Files• Schematic• Fabrication Print	

Overview

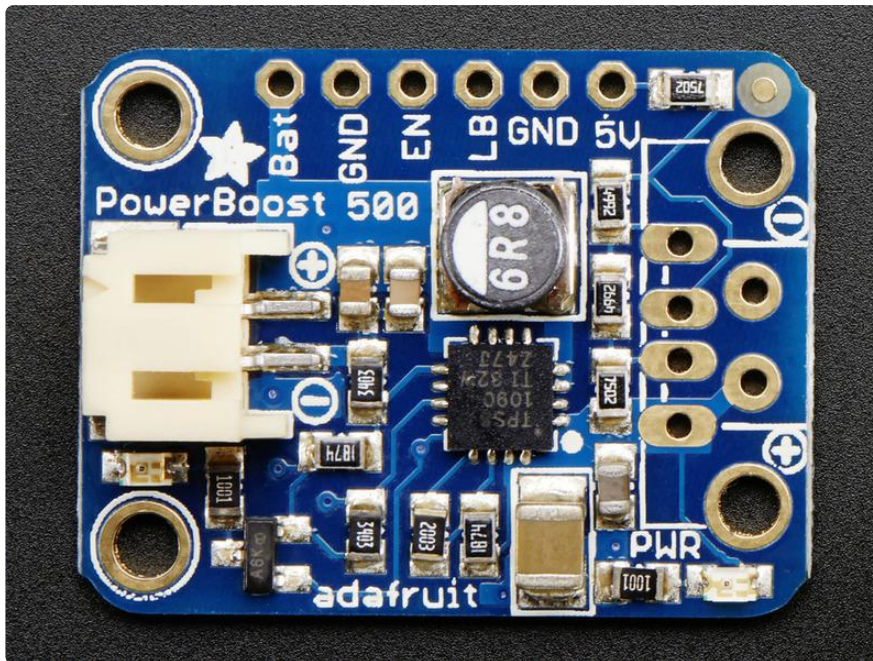

[PowerBoost is the perfect power supply for your portable project!](#) () This little DC/DC boost converter module can run from 1.8V batteries or higher, and convert that voltage to 5.2V DC for running your 5V projects. Like our popular [5V 1A USB wall adapter](#) (), we tweaked the output to be 5.2V instead of a straight-up 5.0V so that there's a little bit of 'headroom' for long cables, high draw, the addition of a diode on the output if you wish, etc. The 5.2V is safe for all 5V-powered electronics like Arduino, Raspberry Pi, or Beagle Bone while preventing icky brown-outs during high current draw because of USB cable resistance.

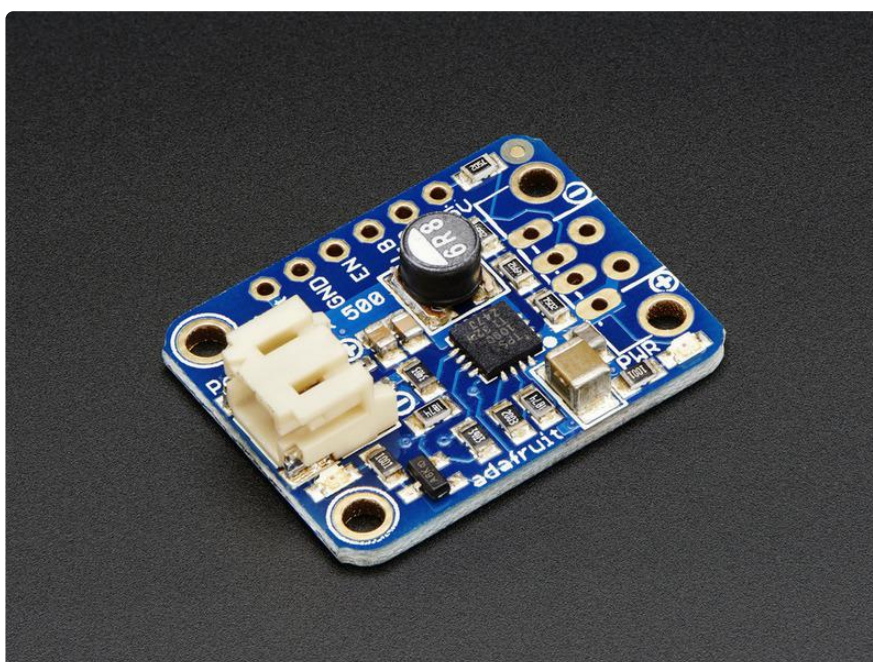

[The PowerBoost 500 \(\)](#) has at the heart a [TPS61090 boost converter from TI \(\)](#). This boost converter chip has some really nice extras such as low battery detection, 2A internal switch, synchronous conversion, excellent efficiency, and 700KHz high-frequency operation. Check out these specs!

- Synchronous operation means you can disconnect the output completely by connecting the ENable pin to ground. This will completely turn off the output
- 2A internal switch (~2.5A peak limiting) means you can get 500mA+ from as low as 1.8V, 750mA+ from 2 NiMH or Alkaline batteries, and at least 1000mA from a 3.7V LiPoly/Lilon battery or 3 NiMH/Alkalines.
- Low battery indicator LED lights up red when the voltage dips below 3.2V, optimized for the most common usage of LiPo/Lilon battery usage
- Onboard 500mA charge-rate 'iOS' data resistors. Solder in the USB connector and you can plug in any iPhone or iPod for 500mA charge rate. Not suggested for iPad (which really needs 1A charge rate).
- Full breakout for battery in, control pins and power out
- 90%+ operating efficiency in most cases (see datasheet for efficiency graphs), and low quiescent current: 5mA when enabled and power LED is on, 20uA when disabled (power and low batt LED are off)

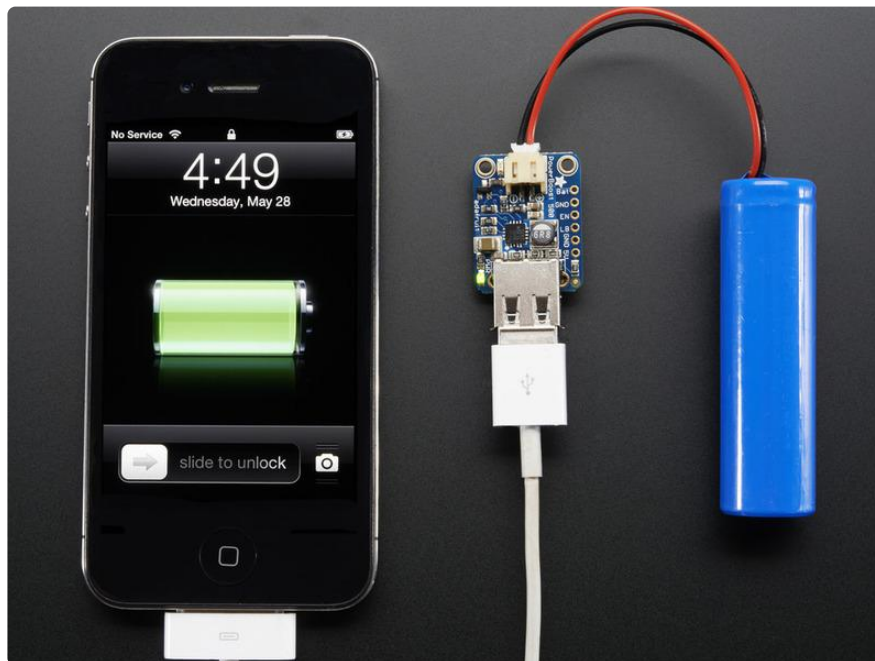

Great for powering your robot, Arduino project, single-board-computer such as Raspberry Pi or BeagleBone! Each order comes with one fully assembled and tested PCB and a loose USB A jack. If you are powering your project from USB, solder the USB A jack in (a 3-minute soldering task). [If you would like to use a terminal block, pick up a 3.5mm 2pin block here \(\)](#) and solder to the output spot where the USB jack would go. Or dont solder anything in for a more compact power pack.

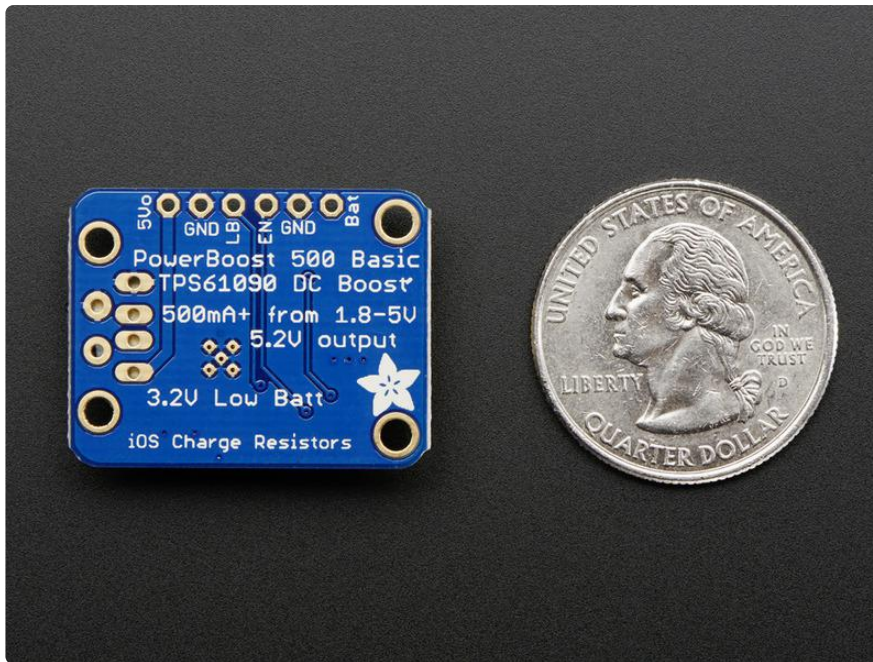

If you're trying to figure out how much current your project is using, check out the [CHARGER DOCTOR!](http://adafru.it/1852) (<http://adafru.it/1852>)



Pinouts

For many people, the PowerBoost can be used with just the power input and power outputs. However, we have a couple handy breakouts so lets get started!

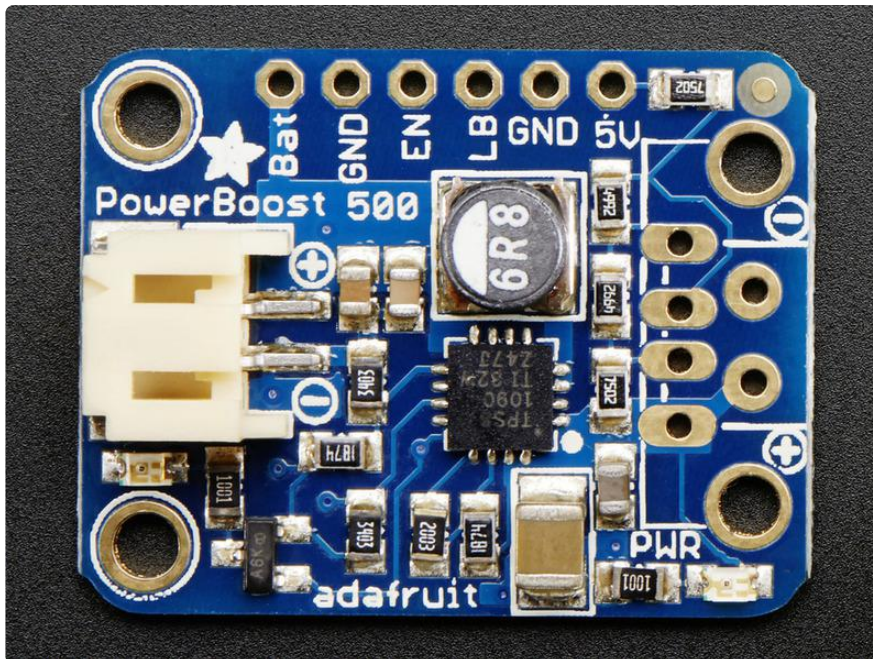

Power Pins

There's two power 'ports' - an input (called BAT) and an output (called 5V)

- BAT - this is the battery input, it can range from 1.8V to 5V. Higher voltages will let you draw more current and in general, are more efficient. Try to keep the wires going to this pin nice and short - 3" or less is best!
- GND - this is the power ground. This boost converter is not 'isolated' - the ground input is the same as the ground output
- 5V - this is the boosted output. When the board is running, the voltage will be 5.2V approximately. It may dip down to 5V as the current draw starts to go up (over 500mA). When the board is disabled, this output is 'floating' but you should still try not to apply a voltage to it while the board is disabled. There's a green LED connected to this pin which will let you know when there's power output

Using a bench-top supply or long wires can add too much inductance to the input of the boost converter and destroy it! We really do recommend using Lipoly batteries with short wires

Control Pins

There's two 'control' pins.

- EN - this is the 'enable' pin. By default it is pulled 'high' to VBAT. To turn off the booster, connect this pin to ground. The switch can be as small as you like, it is just a signal. Contrast this to an inline power switch which would have to be able to handle up to 2A of current! When the chip is disabled the output is completely disconnected from the input.
- LBO - not a leveraged buy out! this is the Low Battery Output. By default it is pulled high to BAT but when the charger detects a low voltage (under 3.2V) the pin will drop down to 0V. You can use this to signal when its time to shut down or alert the user that the battery is low. There is also a red LED connected to this pin.

LEDs

There are two onboard LEDs. The Green LED sits next to the USB connector socket, and indicates the 5V output power state. The Red LED is next to the battery JST port and indicates when the battery voltage is below 3.2VDC

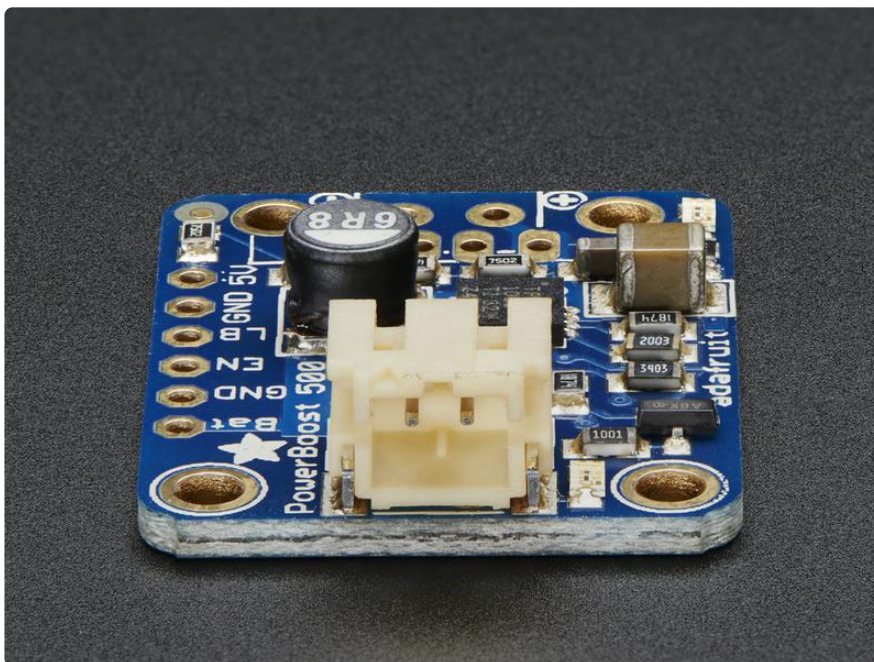

Battery and USB connection

You can connect a battery to the breakout strip or to the JST connector. All of Adafruit batteries come with JST cables that will plug in nicely. Watch the polarity of the cable! the + and - markings next to the JST will let you know which way is which.

The USB connector can be soldered on to create a portable 'USB power pack'. The two data lines on USB have resistor dividers that match Apple charger values so that you can plug any iOS device in to charge. 99% of other phones, devices and tables are totally cool with these resistors as well. You can always short the D+ and D- lines if you happen to have a phone that wants shorted data lines.

If you don't want a USB connector attached, there are two holes that are designed for a 3.5mm spaced terminal block (not included)

Downloads

Datasheets & Files

- [TPS61090 datasheet](#) ()(the DC/DC boost control chip used)
- [Fritzing object in Adafruit Fritzing library](#) ()
- [EagleCAD PCB files in GitHub](#) ()

Schematic

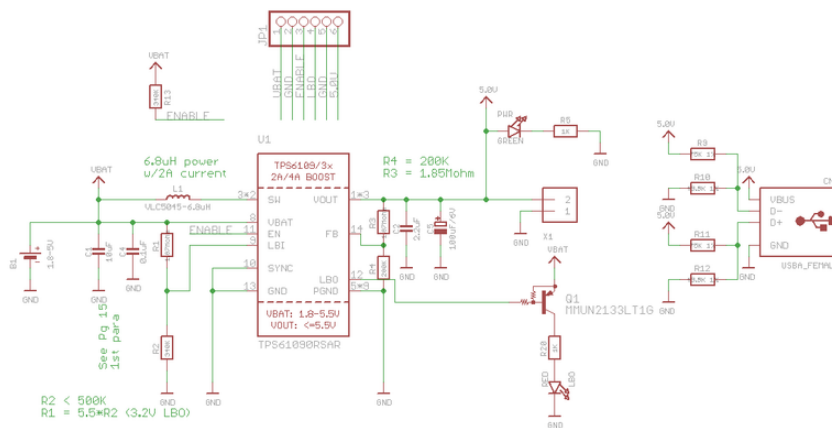

ISSUE	ADAFRUIT INDUSTRIES		© 2014
DRAWN	TITLE		REV
KTOWN			↑
CHECKED	DATE	DRG No	
>CHECKED	not saved!	>DRGNO	
DATE	FILE: TPS6109x_Boost_Rev-B lite		PAGE: 1/1
>DATE			

Fabrication Print

Dimensions in Inches

