

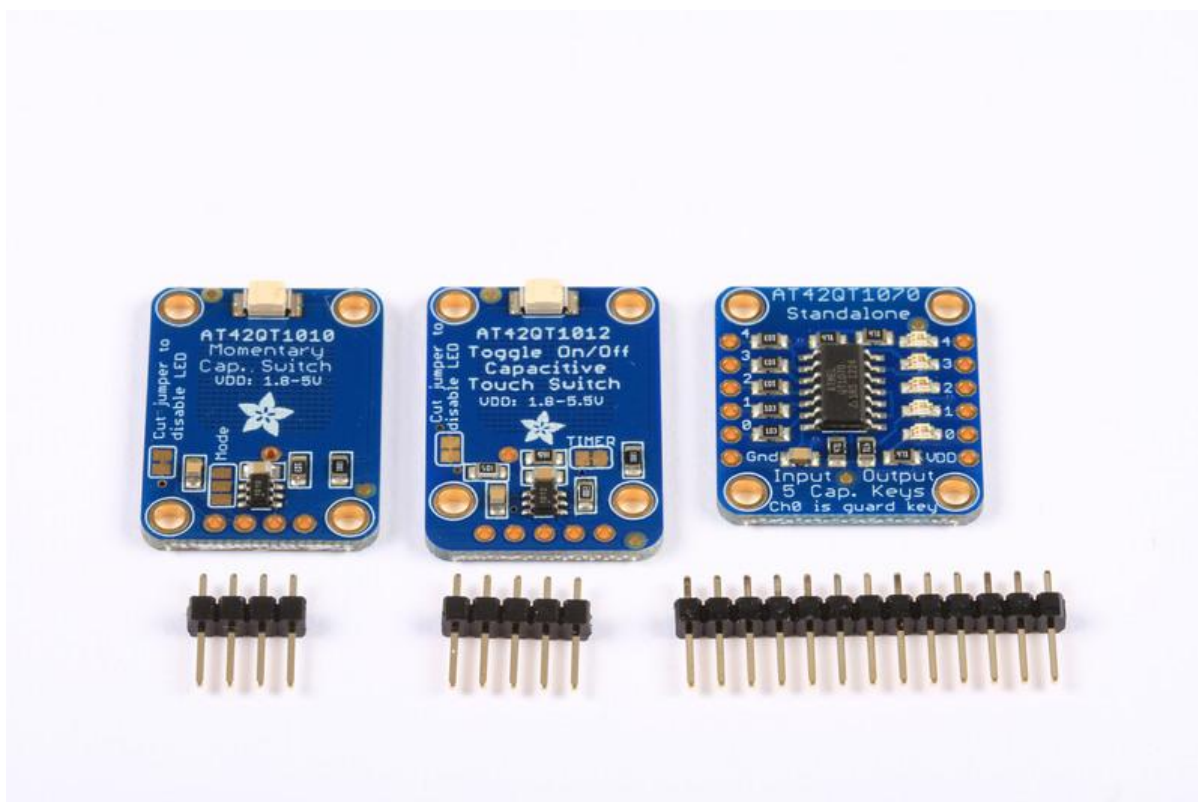

Adafruit Capacitive Touch Sensor Breakouts

Created by Bill Earl



<https://learn.adafruit.com/adafruit-capacitive-touch-sensor-breakouts>

Last updated on 2023-08-29 02:21:07 PM EDT

Table of Contents

Overview	3
<ul style="list-style-type: none">• Momentary• Toggle• 5-Pad Momentary	
Assembly and Wiring	6
<ul style="list-style-type: none">• Installing the Headers:• Position the header strips• Position the breakout• And Solder	
Wiring for Toggle and Momentary	7
<ul style="list-style-type: none">• Toggle Operation• Momentary Operation• Other Options:• LED Control• Speed vs. Power (Momentary Only)• Timer (Toggle Only)• Connecting to your Circuit.• Simple Motor Control	
Wiring for 5-pad Momentary	11
Adding Custom Touch Pads	12
<ul style="list-style-type: none">• Wire, Thread, Foil, Fabric, Paint• Connections:• Sensor Pads	
Build a Touch Control Panel	16
<ul style="list-style-type: none">• Design your panel• Cut the touch-pads• Attach the touch-pads• Attach the Wires• Adjust the Wires• Install the Panel• And Test• Connect to your Circuit	
Downloads	22
<ul style="list-style-type: none">• Files• AT42QT1010 Breakout• AT42QT1012 Breakout• AT42QT1070	

Overview

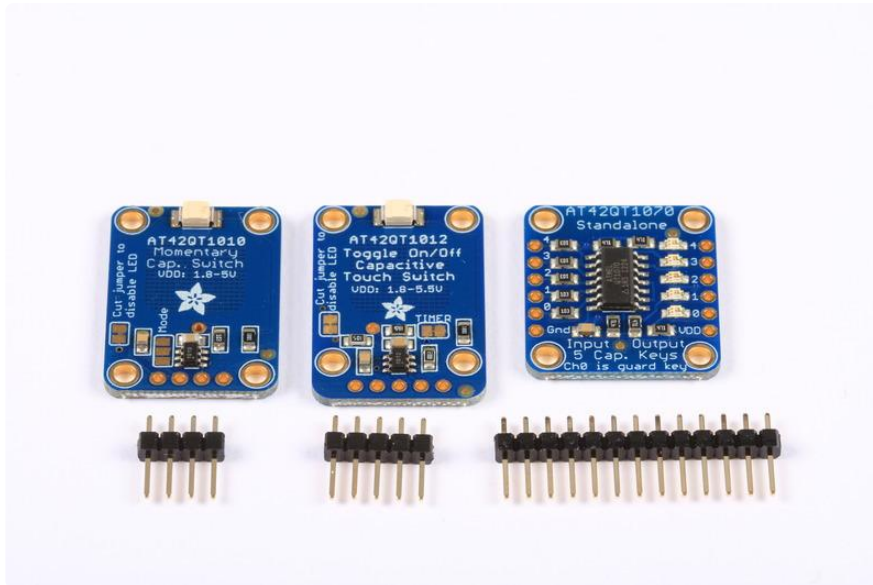

These breakout boards are a simple way to add capacitive touch to your project. Just power with 1.8 to 5.5VDC and touch the pad to activate the sensor. These touch switches interface easily to any project - with or without a microcontroller.

When a capacitive load (such as a human hand) is in close proximity to the sense-pad, the sensor detects the change in capacitance and activates the switch. Custom sense-pads can be made from nearly any conductive material and these sensors can detect touch through thin layers of non-conductive materials such as glass, plastic, fabric or even wood.

The breakouts come in three styles:

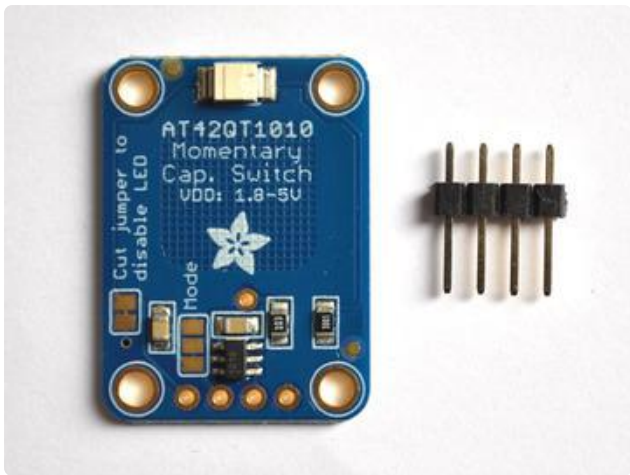

Momentary

This sensor has a built-in sense-pad and is active for as long as the sensor area is touched.

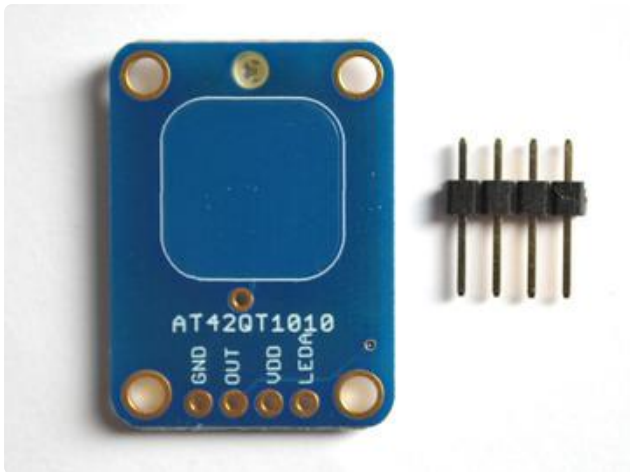

The sense-pad can be extended with wire and almost any conductive material.



Toggle

This sensor also has a built-in sense-pad. It becomes active when touched and remains active until it is touched again.

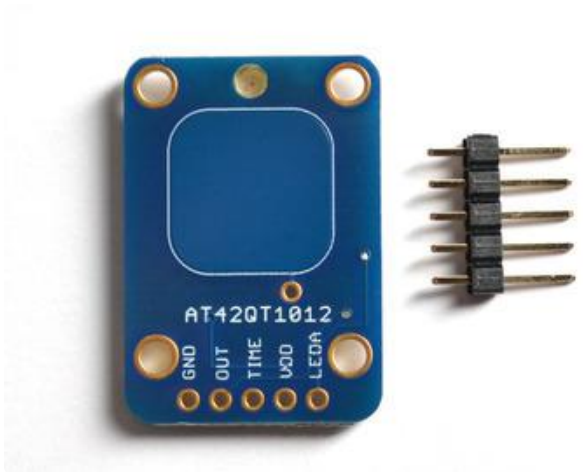

As with the momentary sensor, the sense-pad can be extended with wire and almost any conductive material.

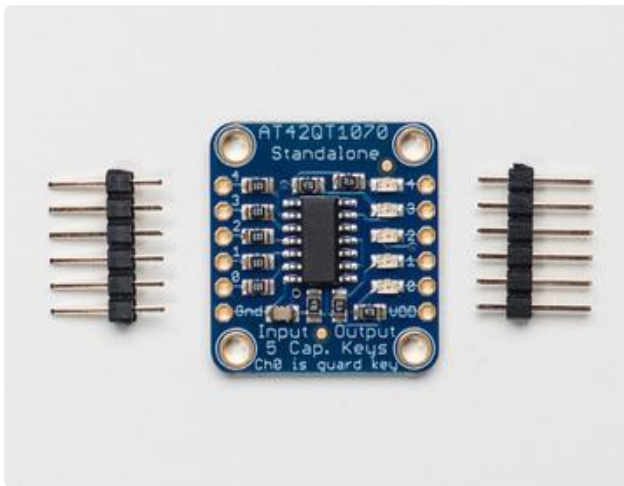

5-Pad Momentary

This version combines 5 momentary switches into one breakout. There are 5 pins for attaching wires to up to 5 external sensor pads.

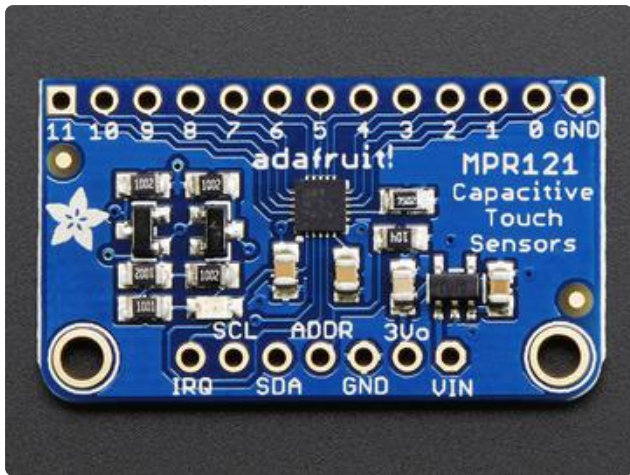

We also have a new 12-Key version with its own tutorial over here! ([link](#))

Assembly and Wiring

These breakouts come fully assembled. For use in a breadboard, you may want to take a couple minutes to install the included header strips:

Installing the Headers:

Install the headers by following these 3 easy steps. The photographs below show one of each sensor type.

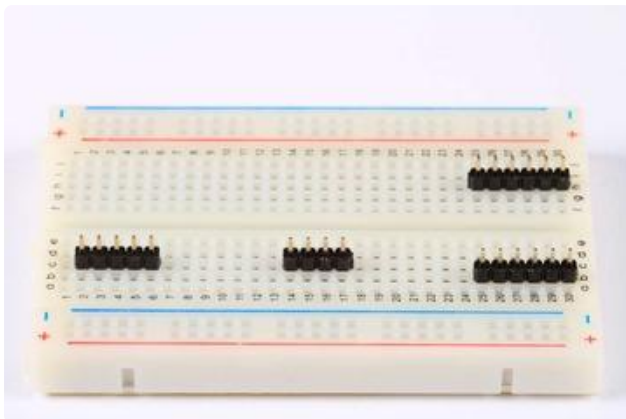

Position the header strips
Plug them long-pins down into a breadboard to stabilize them for soldering.

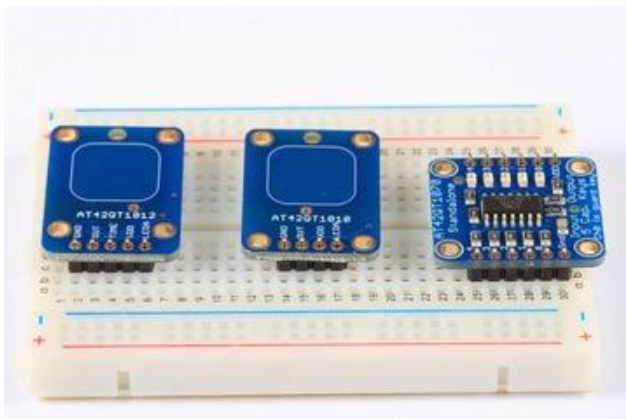

Position the breakout
Place the breakout board over the header pins.

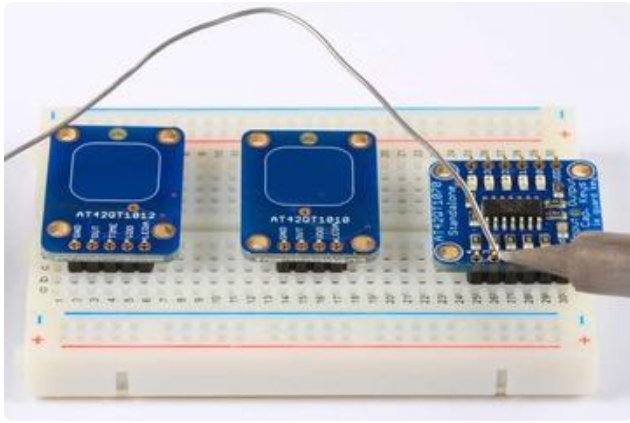

And Solder

Solder each pin for solid electrical contact.

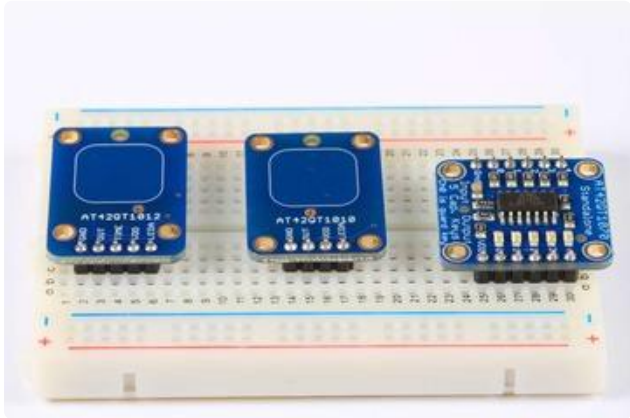

Wiring for Toggle and Momentary

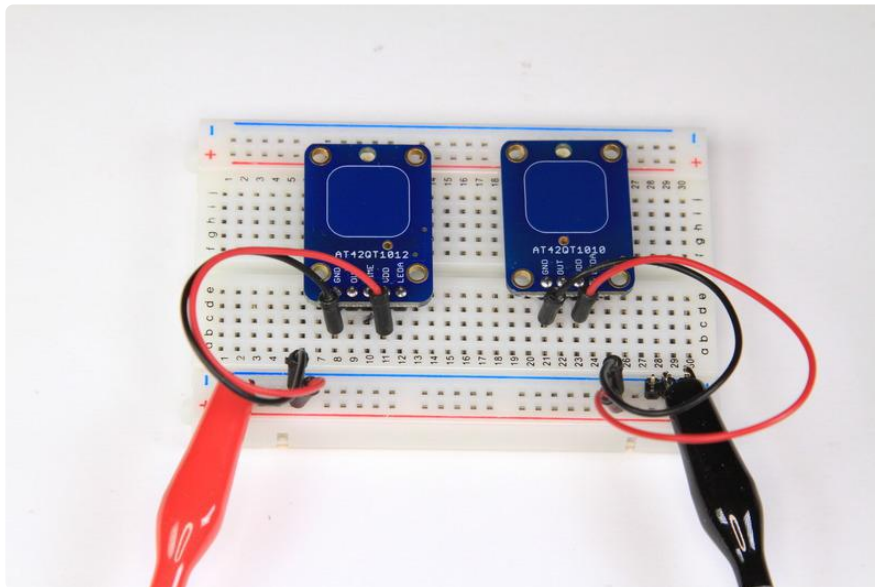

These two breakouts are very similar and can be powered by anything from 1.8V to 5.5V DC. Simply connect Ground to GND and the positive voltage to VDD. The standalone sensors are fully functional without further connections.

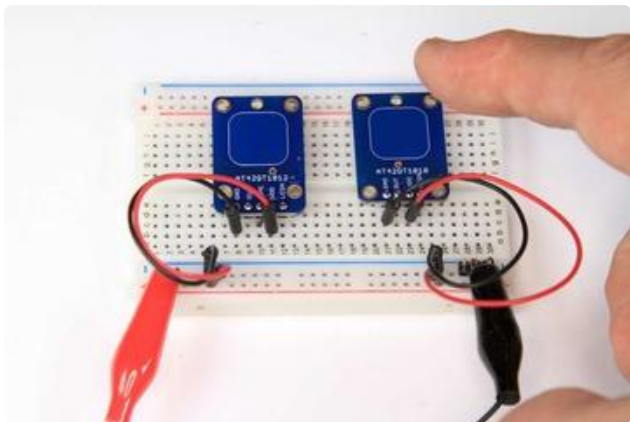
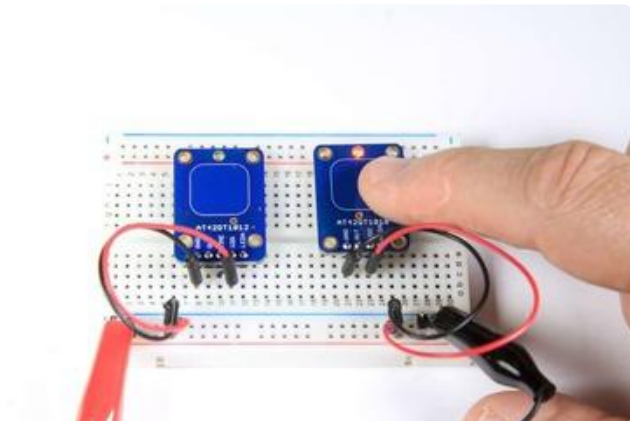
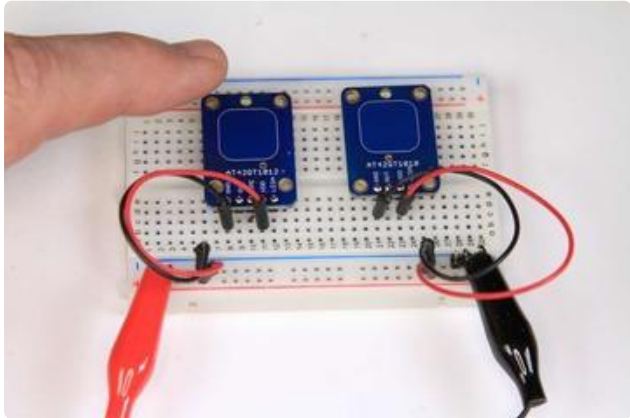
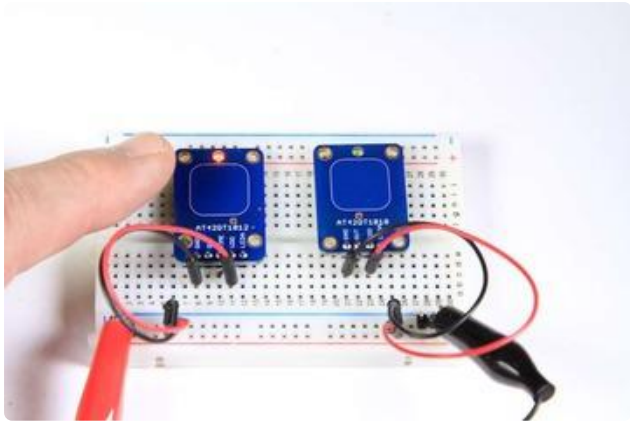

Toggle Operation

The Toggle version of the sensor turns on when you touch it once, then turns off when you touch it again. The on-board LED indicates the state of the switch.

Momentary Operation

The momentary touch sensor works just like a momentary switch. It is on when you touch it and off when you move away. The on-board LED indicates the state of the switch.

Other Options:

These sensors have several jumper configurable operating modes as described below:

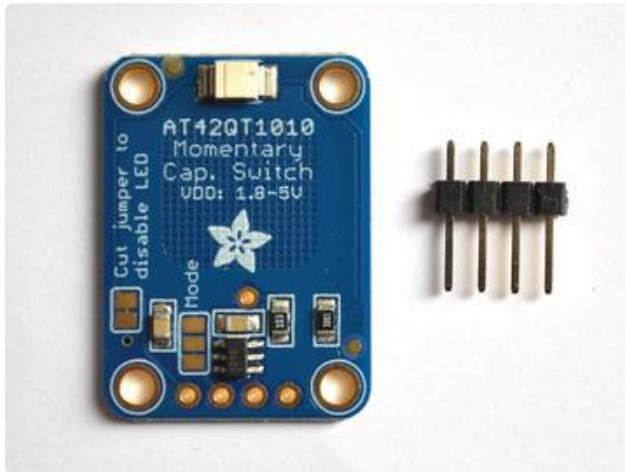

LED Control

The led indicators can be disabled for ultra-low power applications. To disable the LED, simply cut the jumper between the pads where indicated on the back of the breakout board.

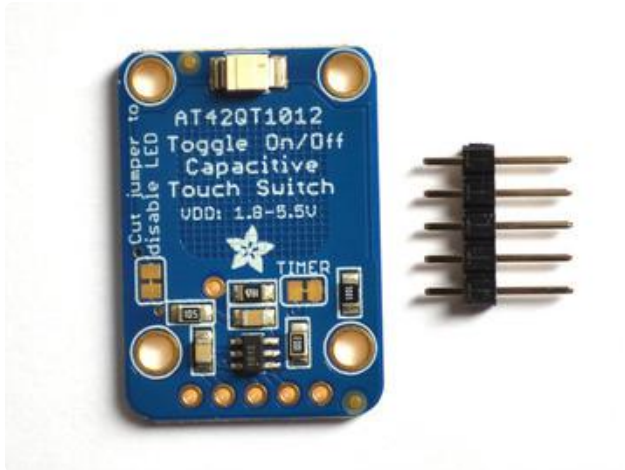

With the jumper cut, the LED can be controlled externally via the LED pin on the header.

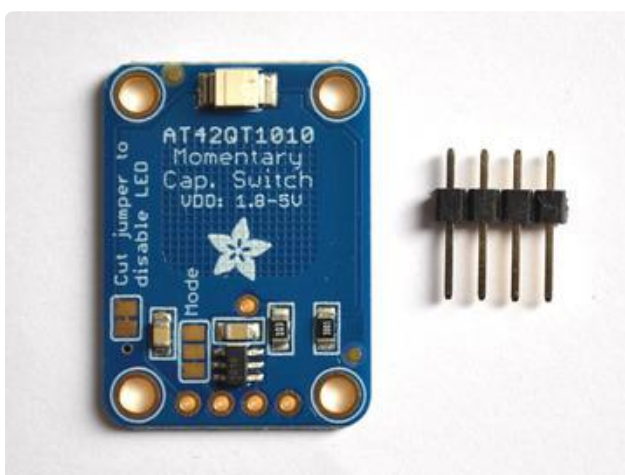

Speed vs. Power (Momentary Only)

The Momentary version can be configured for "Fast" mode (default) or low-power mode. Fast mode requires 0.5mA. Low Power mode requires just 50uA. To switch between the two, cut the jumper on one side of the "mode" pads and bridge the other side with a drop of solder.

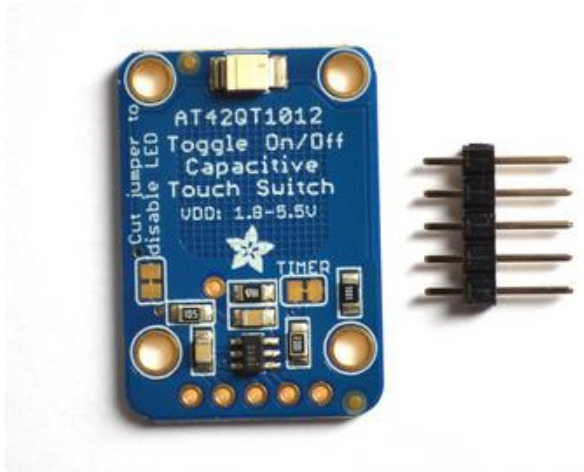

Timer (Toggle Only)

By default, the toggle sensor is configured for infinite time-out. It will stay on until you touch the sensor to turn it off. It also supports a configurable time-out to turn off the output automatically after a delay. To select this mode, cut the 'TIMER' jumper and connect a resistor & capacitor to the TIME pin. For a circuit diagram and resistor/capacitor calculations, see page 13 of the [datasheet](#) ().

You can also just connect TIME to Vdd and the chip will turn off approx 15 minutes after being turned on. Connect TIME to OUT and the chip will time-out approx one hour after being turned on.

Connecting to your Circuit.

The outputs of these touch switches are 'active high'. Use them like a positive logic signal, or a pushbutton that shorts to VCC.

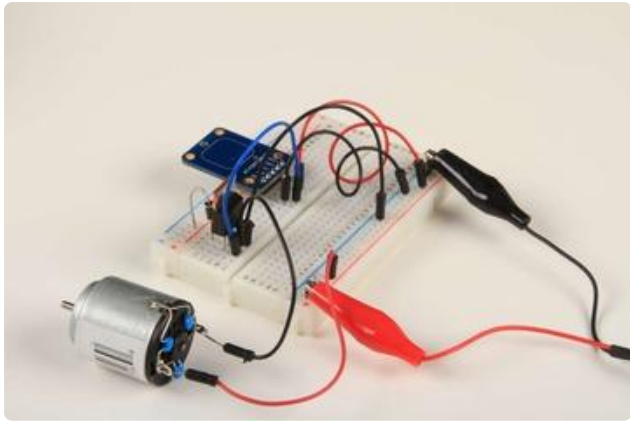

Simple Motor Control

You can use it just like a pushbutton or logic signal with a transistor or MOSFET to drive high-current loads like a DC motor.

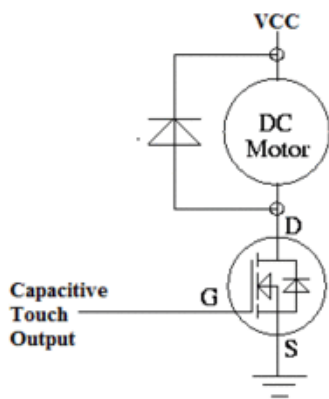

Wiring for 5-pad Momentary

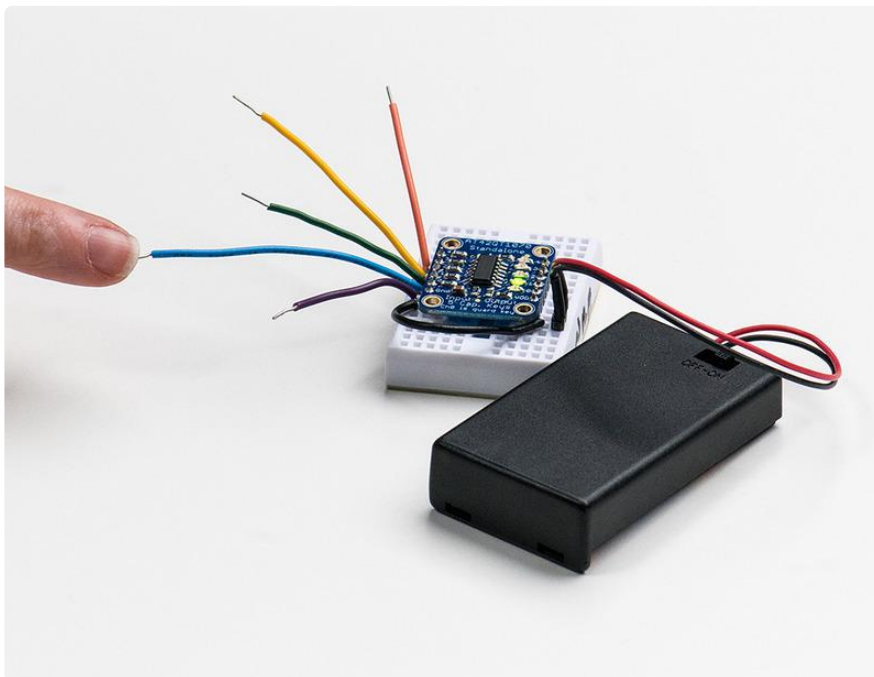

The 5-pin momentary breakout can be powered with anything from 1.8V to 5.5VDC. Just connect ground to GND and the positive voltage to VDD. This sensor does not have built-in touch pads, but you can create your own pads in any size or shape from wire, foil or any other conductive material. Simply connect your touch-pads to each of the 5 sense pins. When you touch the pad, the corresponding LED on the other side will light up. The chip only detects one touch-pad at a time to prevent false readings.

5 touch inputs in one device makes this the perfect component for building your own custom capacitive touch panel!

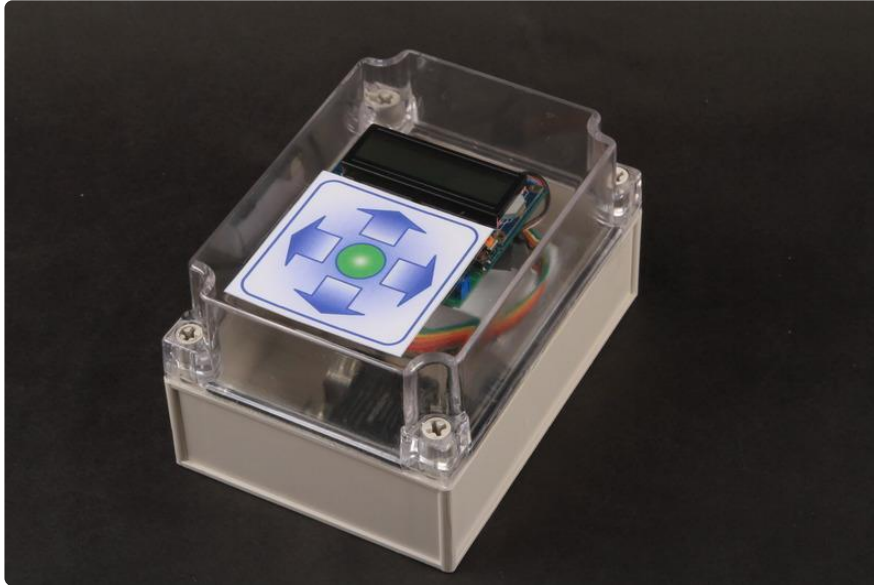

Adding Custom Touch Pads

Custom touch pads are easy to make. You can use almost any conductive material:

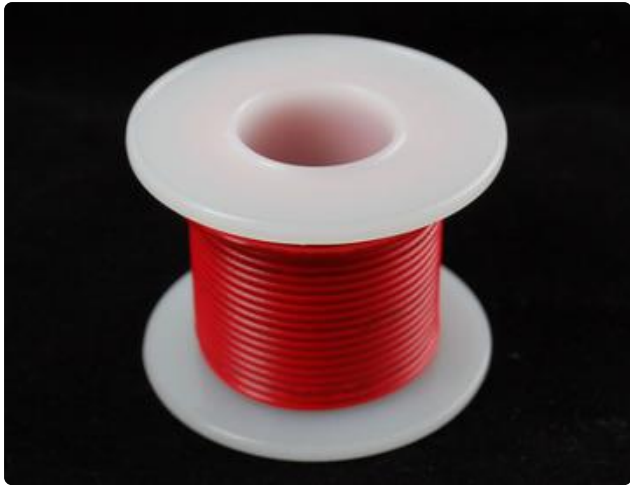

Wire, Thread, Foil, Fabric, Paint

If it will conduct electricity, it will work as a touch sensor!





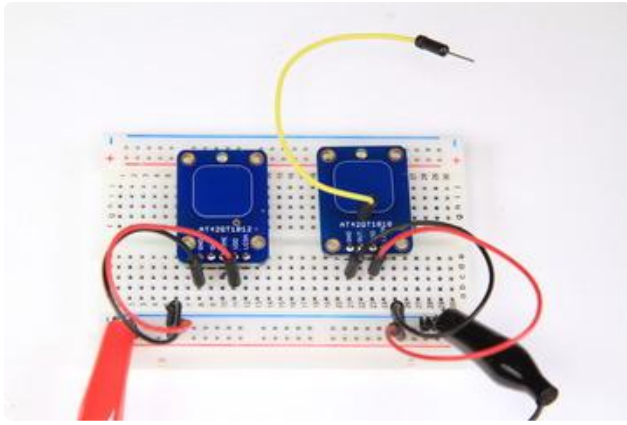

Connections:

The Toggle and Momentary boards have a solder hole located just below the sensor pad for attaching a wire to an external sensor.

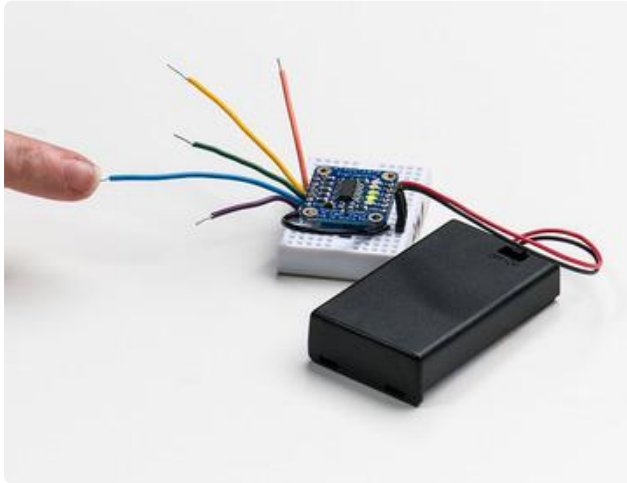

The 5-pad breakout has pins numbered 0-4 on the left side of the board.

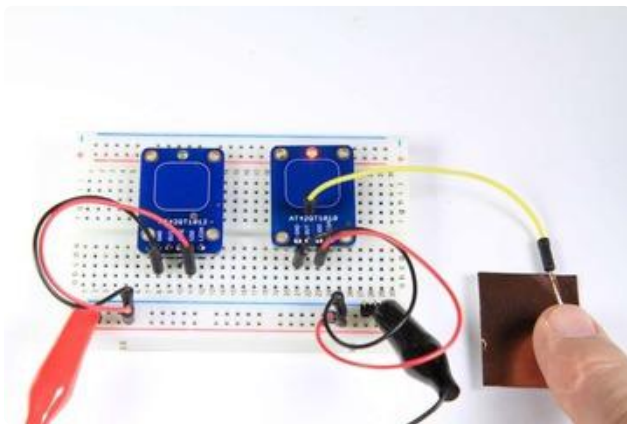

Sensor Pads

Attach the connecting wire to any conductive object or surface. That surface will become touch sensitive. Larger surfaces tend to be more sensitive. You will be able to sense through fabric, plastic, glass and many other non-conductive materials.

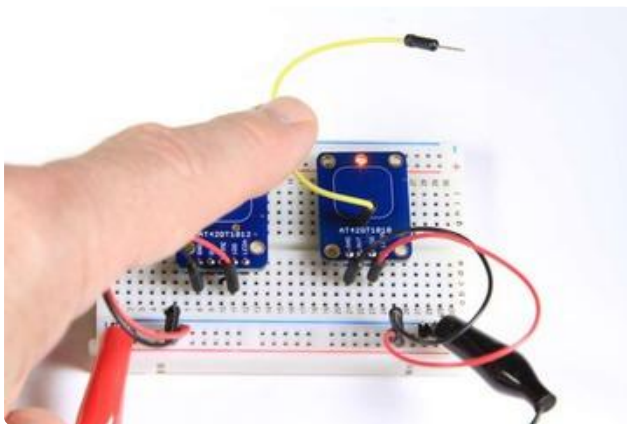

Note that the wire will be touch sensitive too! Be sure to route any connecting wires away from areas where they might create an accidental touch input.

Build a Touch Control Panel

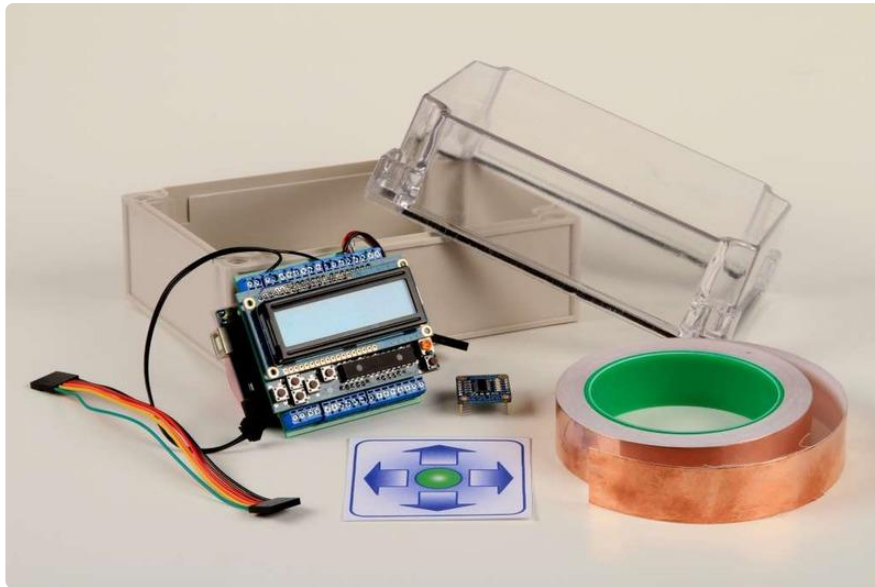

Capacitive touch sensors are a great way to add external controls to a waterproof enclosure. There is no need to drill holes or worry about gaskets and O-rings. These sensors will detect your touch right through the plastic case!

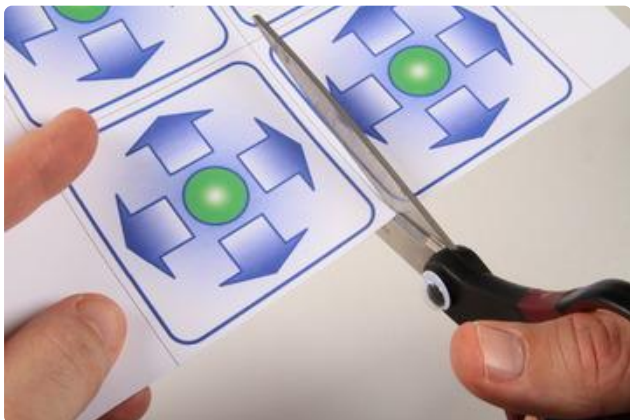

Design your panel

You can draw it by hand, or with your favorite drawing tool and print it on some heavy card-stock.

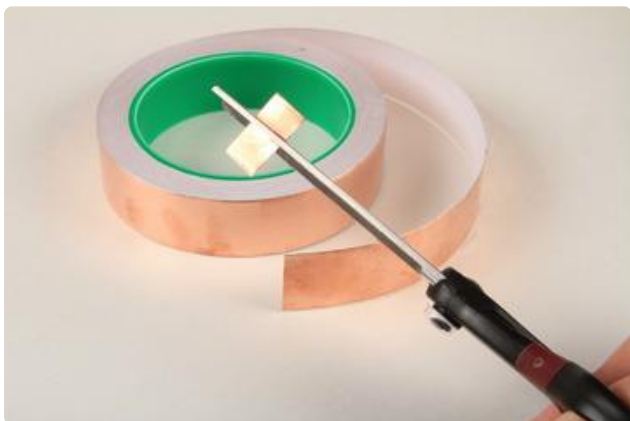

Cut the touch-pads

Cut pads from copper tape. About 1/2" square is a good size for buttons on a touch-pad.

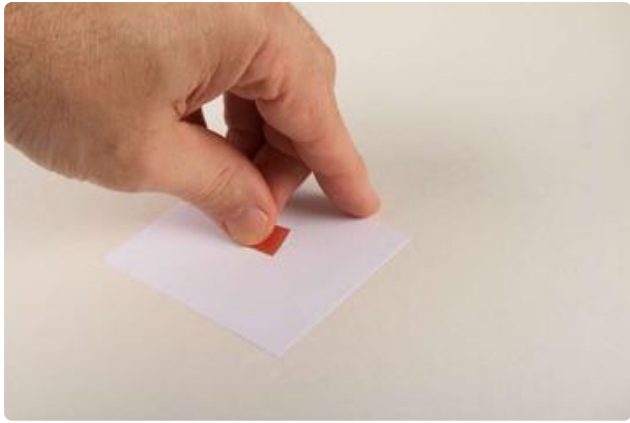

Attach the touch-pads

Peel the release paper from the back of the copper tape and stick the touch-pads to the back of the panel so that they align with the buttons on the front.

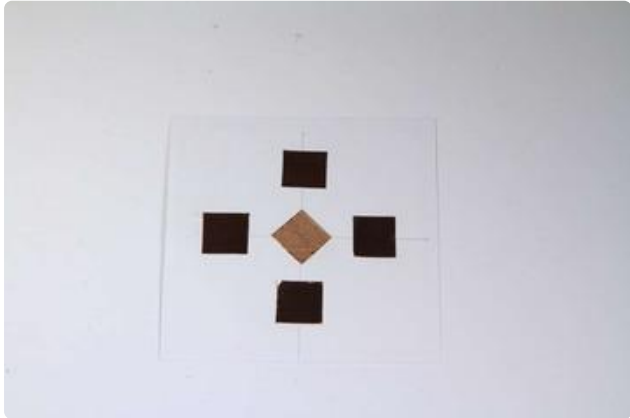

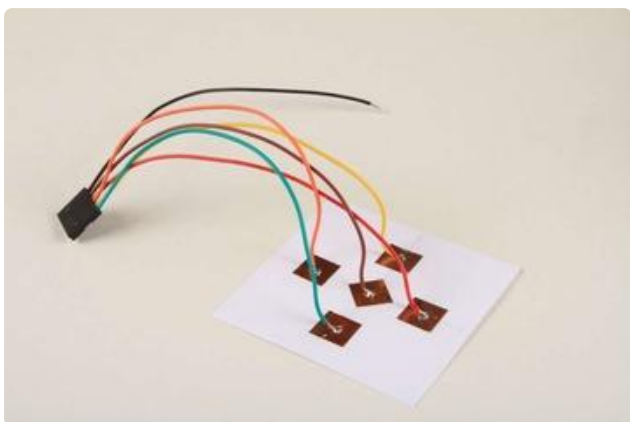
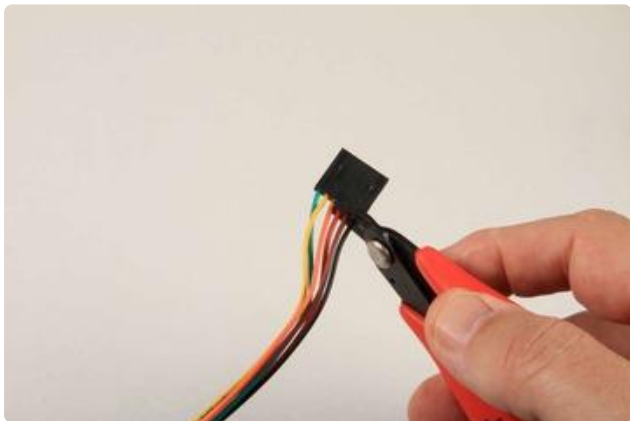
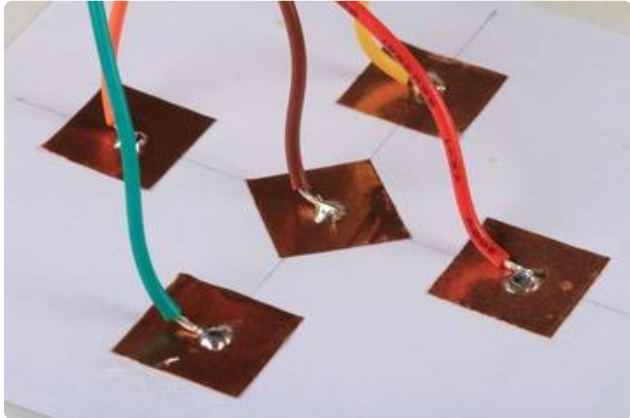
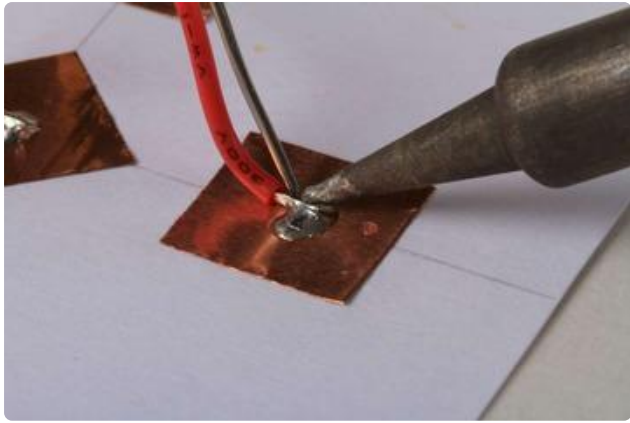

Attach the Wires

Solder wires to the copper touch-pads. For this example, I used a [6-conductor 0.1" socket cable](http://adafru.it/206) with one end cut off to simplify connections to the breakout.

Adjust the Wires

Bend the wires away from the panel. The wires will be touch-sensitive too. To prevent accidental false touches, we want to keep them away from the panel surface.

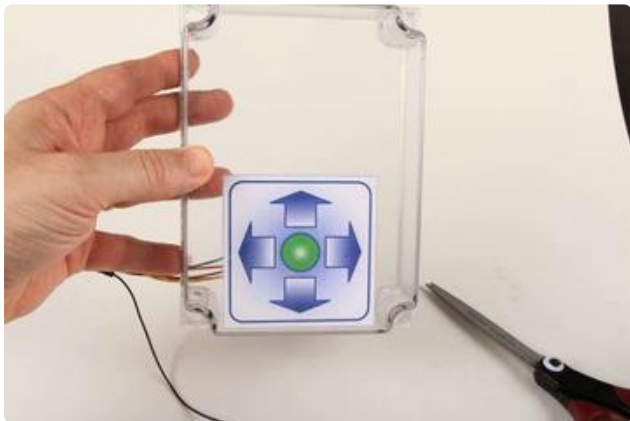
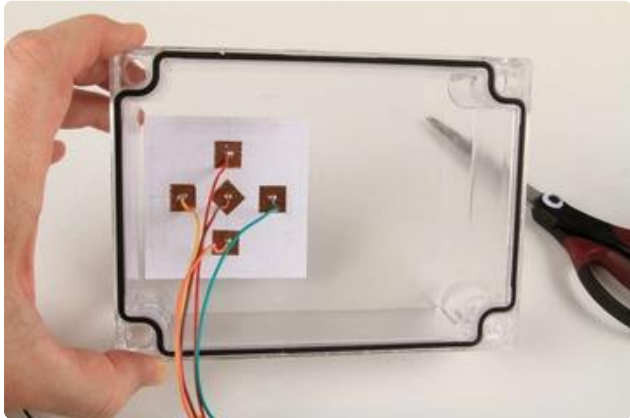
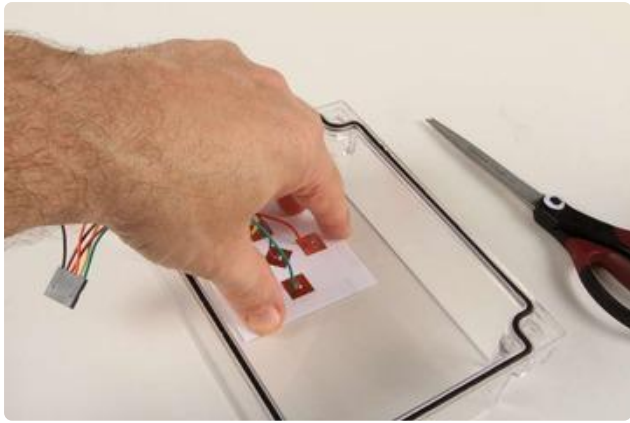

Install the Panel

Tape the panel to the inside of the polycarbonate cover using clear packing tape.

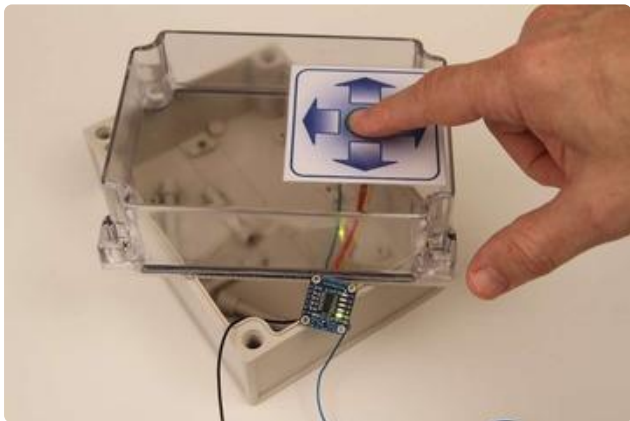
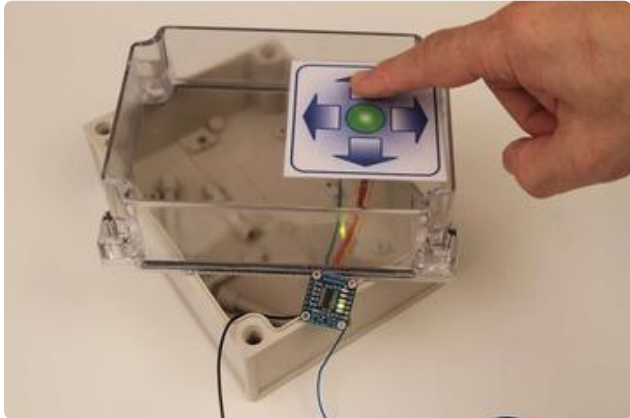
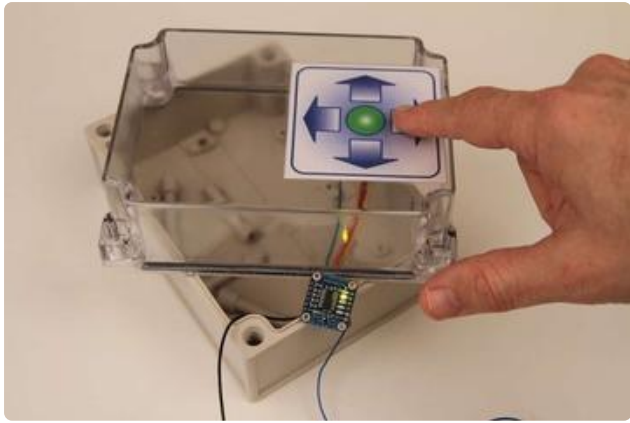

And Test

Connect the cable to the breakout. Power it up and test your control panel. Touching each button should cause a different LED to light up.

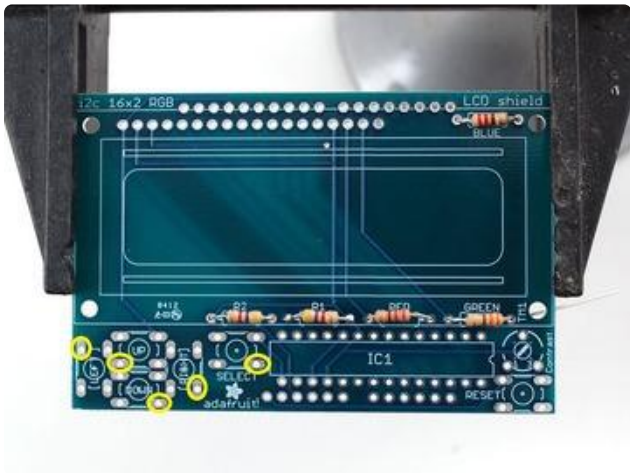
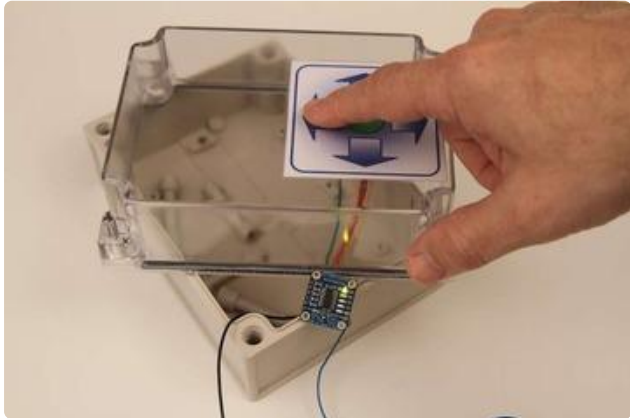
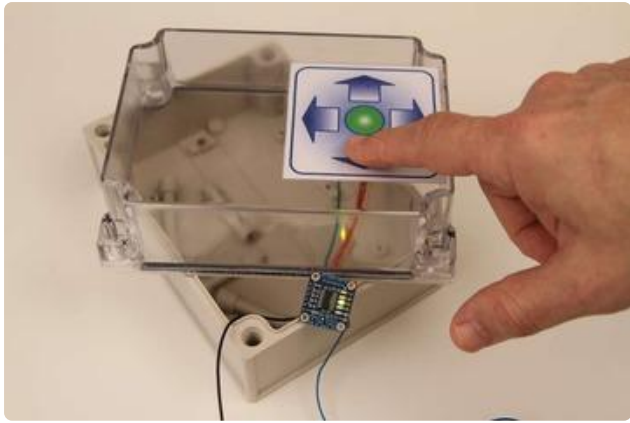

Connect to your Circuit

The output signals are 'active low', so they can replace any pushbutton that shorts to ground - such as the buttons on the RGB LCD shield. You can leave off the buttons and solder directly to the circled pads, or (if your shield is already built), just 'tack-solder' the wires to the legs of the buttons.

When you put it all together, you will have a completely sealed, touch sensitive control panel!

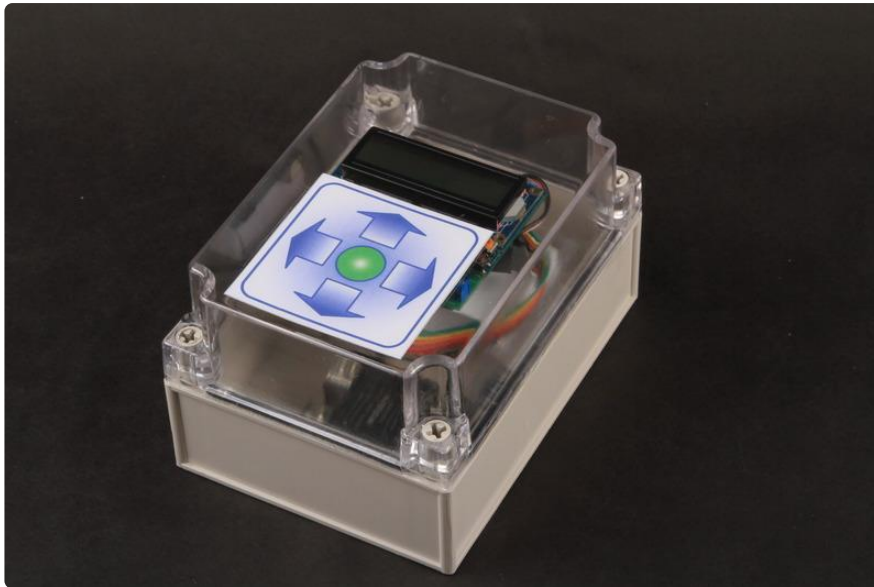

Downloads

Files

- [AT42QT1070 Datasheet \(\)](#)
- [AT42QT1010 Datasheet \(\)](#)
- [AT42QT1012 Datasheet \(\)](#)
- [Objects for all in the Adafruit Fritzing Library \(\)](#)
- [EagleCAD PCB files for all three in GitHub \(\)](#)

AT42QT1010 Breakout

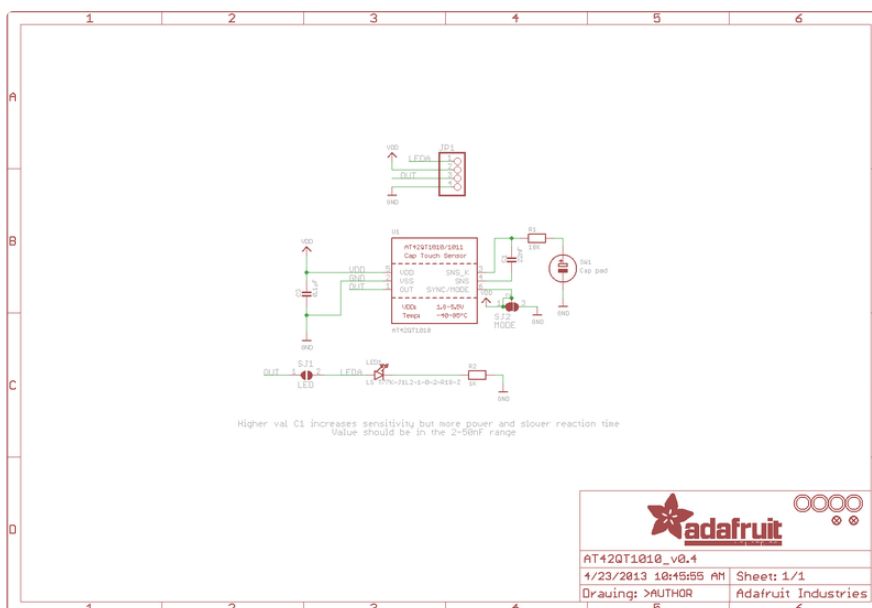

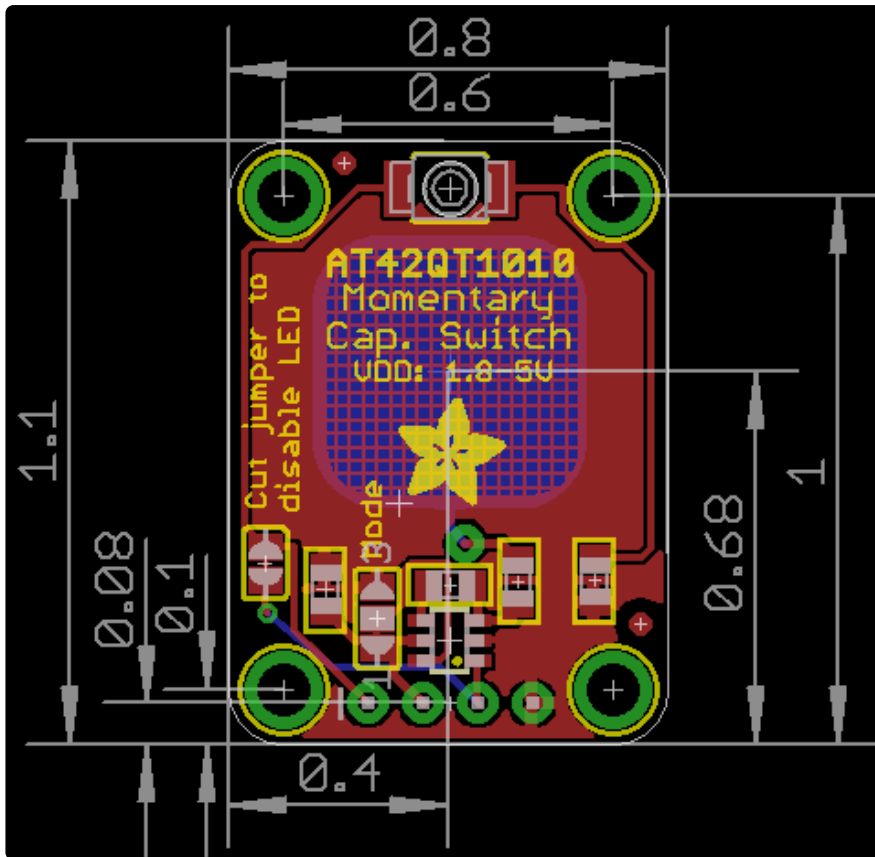

AT42QT1012 Breakout

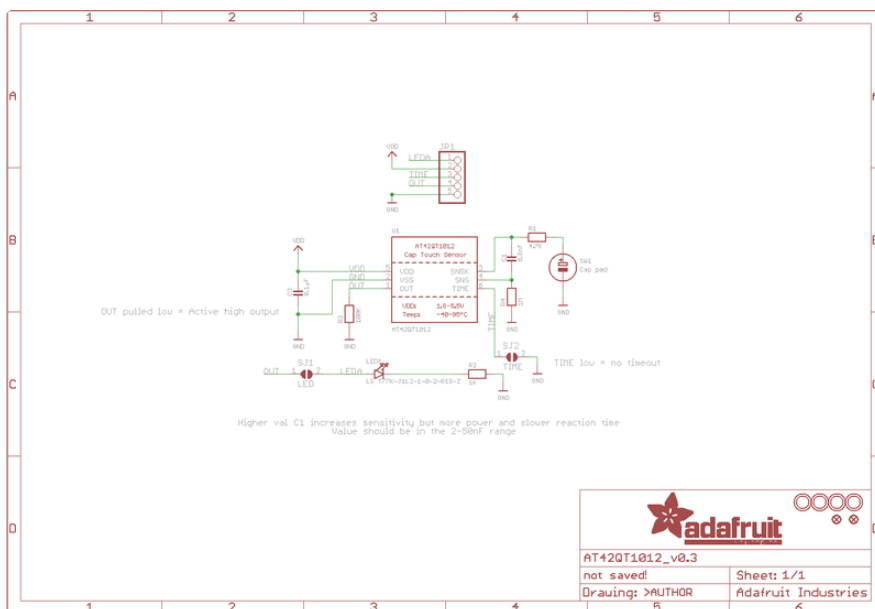

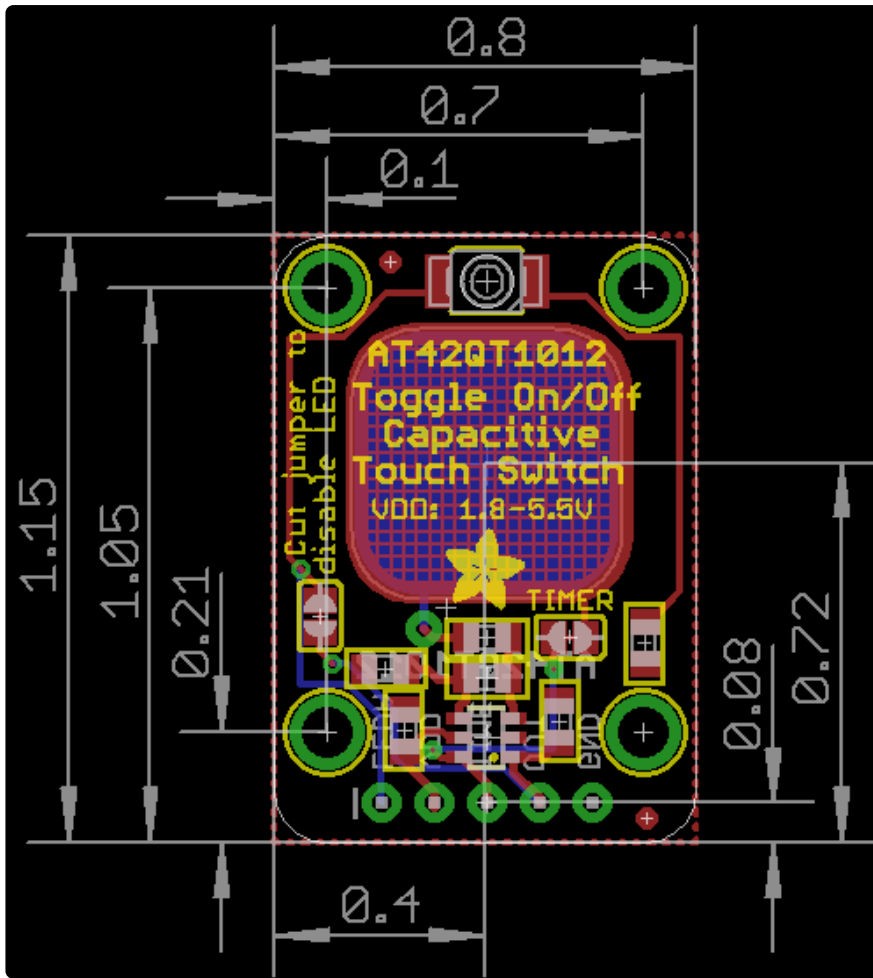

AT42QT1070

