

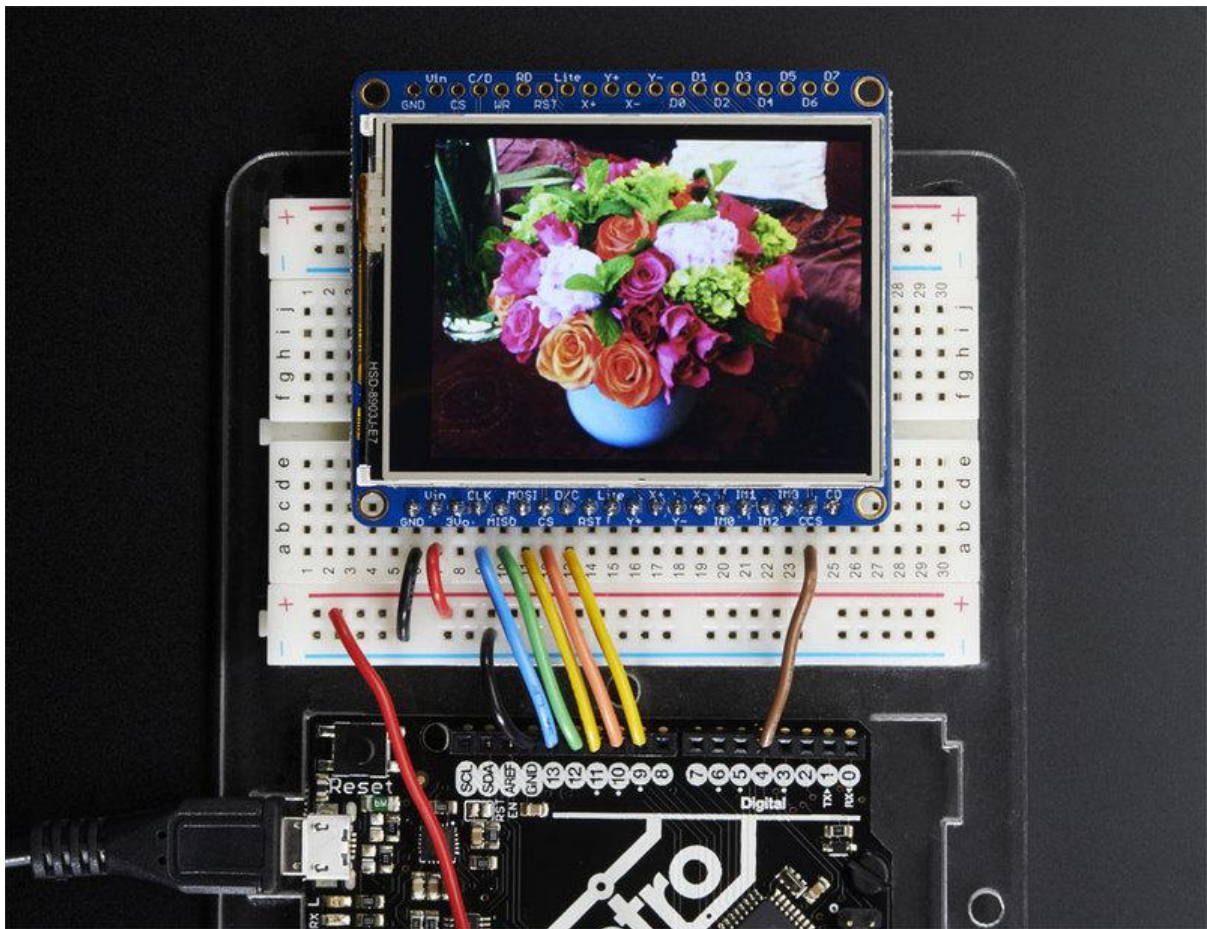

Adafruit 2.4" Color TFT Touchscreen Breakout

Created by lady ada



<https://learn.adafruit.com/adafruit-2-4-color-tft-touchscreen-breakout>

Last updated on 2023-08-29 02:56:54 PM EDT

Table of Contents

Overview	5
Pinouts	7
<ul style="list-style-type: none">• SPI Mode• Resistive touch pins• 8-Bit Mode	
Assembly	10
<ul style="list-style-type: none">• Prepare the header strip:• Add the breakout board:• And Solder!	
Wiring & Test	13
8-Bit Wiring & Test	14
<ul style="list-style-type: none">• 8-Bit Wiring• Part 1 - Power & backlight test• Part 2 - Data Bus Lines• 8-Bit Library Install	
SPI Wiring & Test	20
<ul style="list-style-type: none">• SPI Mode Jumpers• Wiring• Install Libraries• Install Libraries	
Bitmaps (SPI Mode)	25
Adafruit GFX Library	27
Resistive Touchscreen	28
<ul style="list-style-type: none">• Download Library• Touchscreen Paint (SPI mode)• Touchscreen Paint (8-Bit mode)	
CircuitPython Displayio Quickstart	31
<ul style="list-style-type: none">• Preparing the Breakout• Wiring the Breakout to the Feather• Required CircuitPython Libraries• Code Example Additional Libraries• CircuitPython Code Example• Code Details• Using Touch• Where to go from here	
Python Wiring and Setup	39
<ul style="list-style-type: none">• Wiring• ILI9341 and HX-8357-based Displays• ST7789 and ST7735-based Displays• SSD1351-based Displays• SSD1331-based Display	

- Setup
- Python Installation of RGB Display Library
- DejaVu TTF Font
- Pillow Library

Python Usage 47

- Turning on the Backlight
- Displaying an Image
- Drawing Shapes and Text
- Displaying System Information

Troubleshooting 60

Downloads 61

- Datasheets
- Schematic
- Fabrication Print

Overview

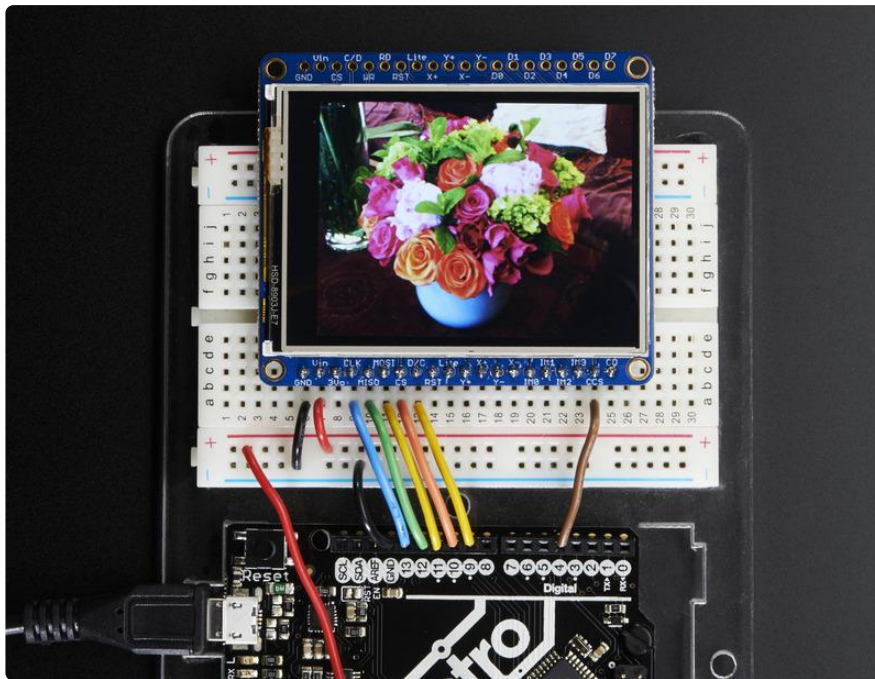

Add some jazz & pizzazz to your project with a color touchscreen LCD. This TFT display is 2.4" diagonal with a bright (4 white-LED) backlight and it's colorful! 240x320 pixels with individual RGB pixel control, this has way more resolution than a black and white 128x64 display.

As a bonus, this display has a resistive touchscreen attached to it already, so you can detect finger presses anywhere on the screen.



This display has a controller built into it with RAM buffering, so that almost no work is done by the microcontroller. The display can be used in two modes: 8-bit or SPI. For 8-bit mode, you'll need 8 digital data lines and 4 or 5 digital control lines to read and write to the display (12 lines total). SPI mode requires only 5 pins total (SPI data in, data out, clock, select, and d/c) but is slower than 8-bit mode.

In addition, 4 pins are required for the touch screen (2 digital, 2 analog) or [you can purchase and use our resistive touchscreen controller \(not included\) to use I2C or SPI \(http://adafru.it/1571\)](http://adafru.it/1571)

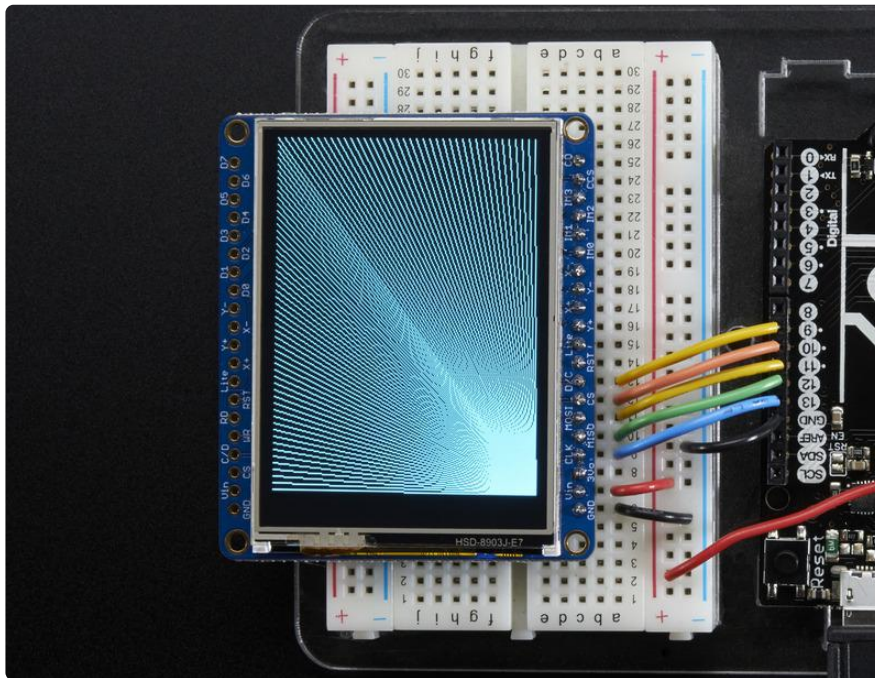

Of course, we wouldn't just leave you with a datasheet and a "good luck!". For 8-bit interface fans [we've written a full open source graphics library that can draw pixels, lines, rectangles, circles, text, and more \(\)](#). For SPI users, we have a library as well (), its separate from the 8-bit library since both versions are heavily optimized.

For resistive touch, we [also have a touch screen library that detects x, y and z \(pressure\) \(\)](#) and example code to demonstrate all of it.

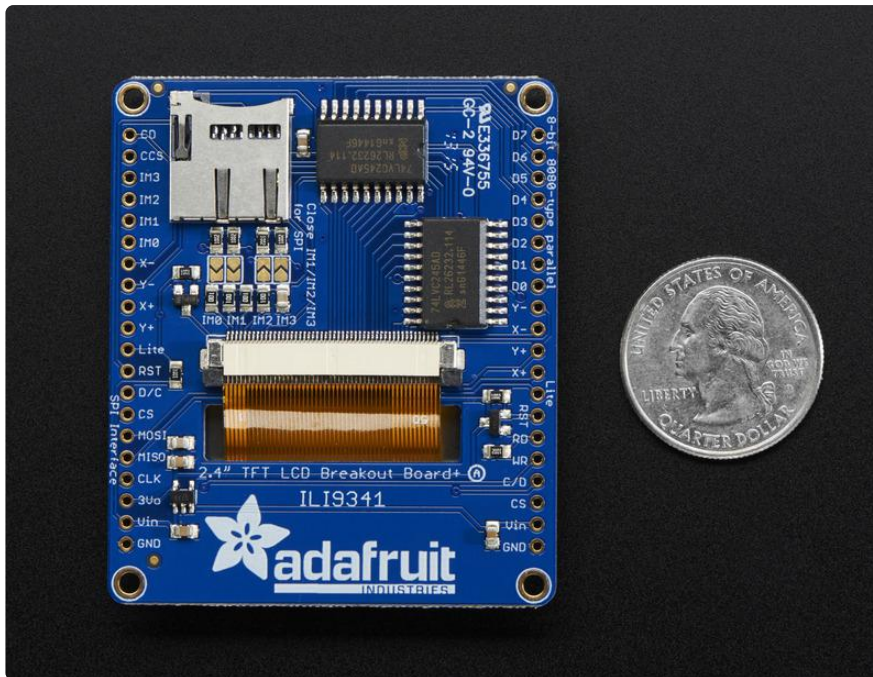

Pinouts

The 2.8" TFT display on this breakout supports many different modes - so many that the display itself has 50 pins. However, we think most people really only use 2 different modes, either "SPI" mode or 8-bit mode (which includes both 6800 and 8080). Each 'side' of the display has all the pins required for that mode. You can switch between modes, by rewiring the display, but it cannot be used in two modes at the same time!

All logic pins, both 8-bit and SPI sides, are 3-5V logic level compatible, the 74LVX245 chips on the back perform fast level shifting so you can use either kind of logic levels. If there's data output, the levels are at at 3.3V

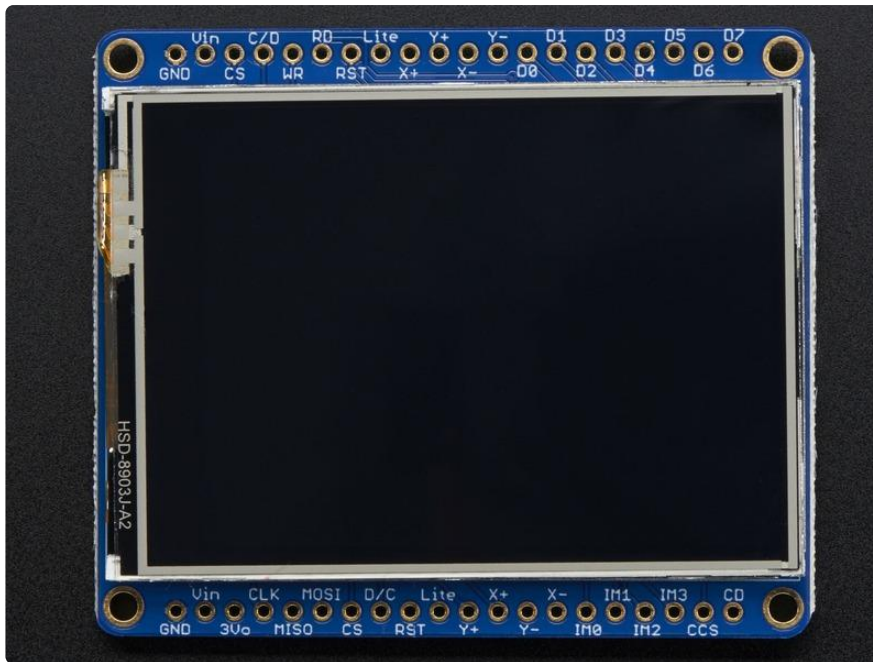

SPI Mode

This is what we think will be a popular mode when speed is not of the utmost importance. It doesn't use as many pins (only 4 to draw on the TFT if you skip the MISO pin), is fairly flexible, and easy to port to various microcontrollers. It also allows using a microSD card socket on the same SPI bus. However, its slower than parallel 8-bit mode because you have to send each bit at a time instead of 8-bits at a time. Tradeoffs!



- GND - this is the power and signal ground pin
- 3-5V / Vin - this is the power pin, connect to 3-5VDC - it has reverse polarity protection but try to wire it right!
- 3.3Vout - this is the 3.3V output from the onboard regulator
- CLK - this is the SPI clock input pin
- MISO - this is the SPI Microcontroller In Serial Out pin, its used for the SD card mostly, and for debugging the TFT display. It isn't necessary for using the TFT display which is write-only
- MOSI - this is the SPI Microcontroller Out Serial In pin, it is used to send data from the microcontroller to the SD card and/or TFT
- CS - this is the TFT SPI chip select pin
- D/C - this is the TFT SPI data or command selector pin

- RST - this is the TFT reset pin. There's auto-reset circuitry on the breakout so this pin is not required but it can be helpful sometimes to reset the TFT if your setup is not always resetting cleanly. Connect to ground to reset the TFT
- Lite - this is the PWM input for the backlight control. It is by default pulled high (backlight on) you can PWM at any frequency or pull down to turn the backlight off
- IM3 IM2 IM1 IM0 - these are interface control set pins. In general these breakouts aren't used, and instead the onboard jumpers are used to fix the interface to SPI or 8-bit. However, we break these out for advanced use and also for our test procedures
- Card CS / CCS - this is the SD card chip select, used if you want to read from the SD card.
- Card Detect / CD - this is the SD card detect pin, it floats when a card is inserted, and tied to ground when the card is not inserted. We don't use this in our code but you can use this as a switch to detect if an SD card is in place without trying to electrically query it. Don't forget to use a pullup on this pin if so!

Resistive touch pins

- Y+ X+ Y- X- these are the 4 resistive touch screen pads, which can be read with analog pins to determine touch points. They are completely separated from the TFT electrically (the overlay is glued on top) They can be used in 8-bit or SPI mode.

8-Bit Mode

This mode is for when you have lots of pins and want more speed. In this mode we send 8 bits at a time, so it needs way more pins, 12 or so (8 bits plus 4 control)! If your microcontroller



- GND - this is the power and signal ground pin
- 3-5V (Vin)- this is the power pin, connect to 3-5VDC - it has reverse polarity protection but try to wire it right!
- CS - this is the TFT 8-bit chip select pin (it is also tied to the SPI mode CS pin)

- C/D - this is the TFT 8-bit data or command selector pin. It is not the same as the SPI D/C pin! Instead, it's the same as the SPI CLK pin.
- WR - this is the TFT 8-bit write strobe pin. It is also connected to the SPI D/C pin
- RD - this is the TFT 8-bit read strobe pin. You may not need this pin if you don't want to read data from the display
- RST - this is the TFT reset pin. There's auto-reset circuitry on the breakout so this pin is not required but it can be helpful sometimes to reset the TFT if your setup is not always resetting cleanly. Connect to ground to reset the TFT
- Backlight - this is the PWM input for the backlight control. It is by default pulled high (backlight on) you can PWM at any frequency or pull down to turn the backlight off
- D0 thru D7 - these are the 8 bits of parallel data sent to the TFT in 8-bit mode. D0 is the least-significant-bit and D7 is the MSB

Assembly

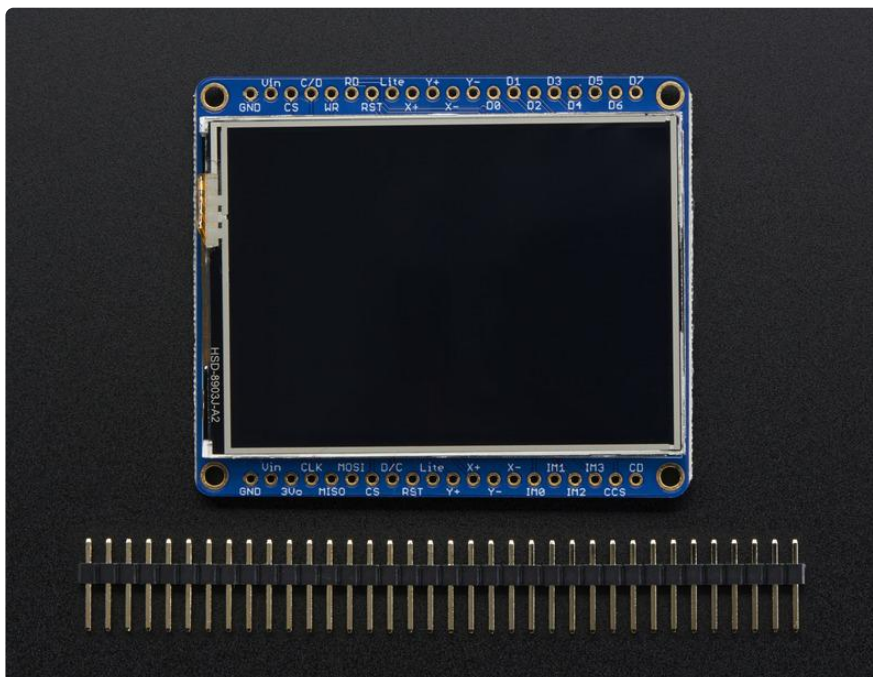

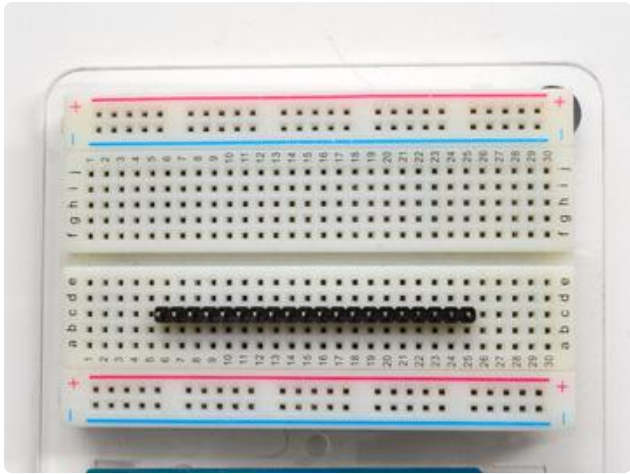

Prepare the header strip:

Cut the strip to length if necessary. It will be easier to solder if you insert it into a breadboard - long pins down

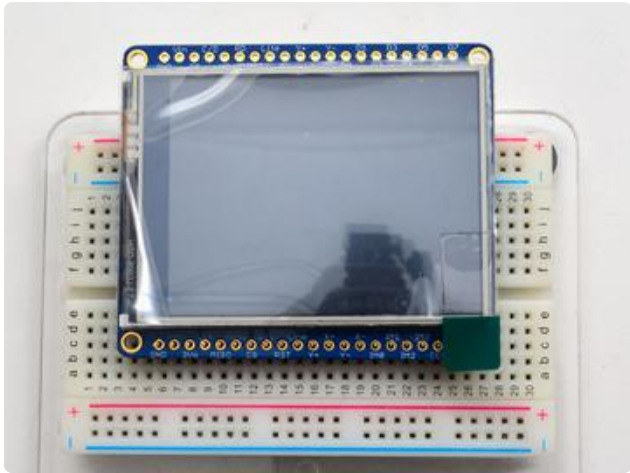

Add the breakout board:

Place the breakout board over the pins so that the short pins poke through the breakout pads

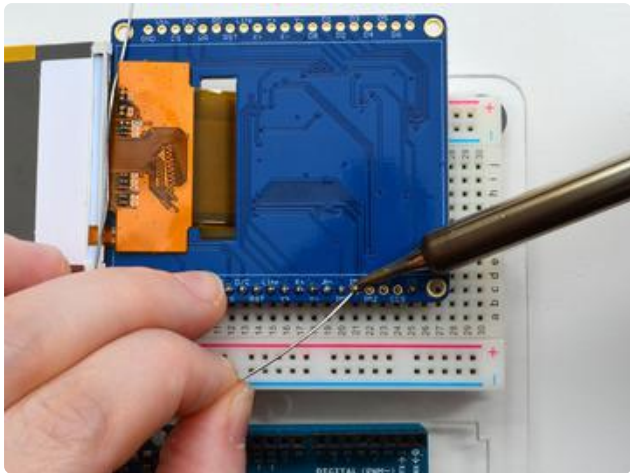
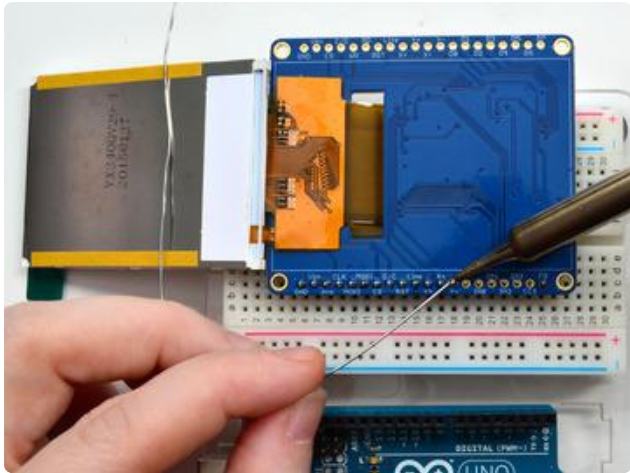
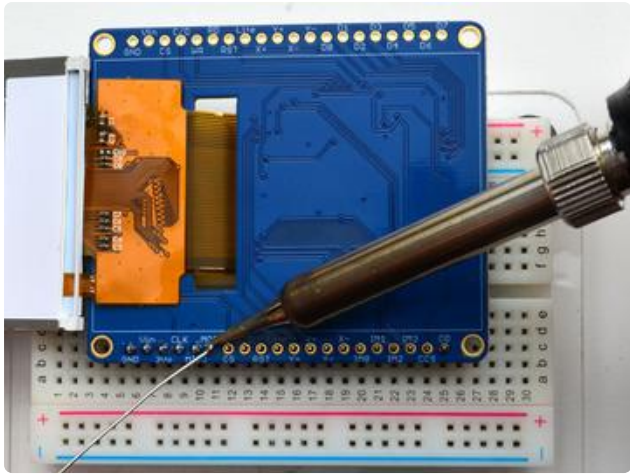

And Solder!

Be sure to solder all pins for reliable electrical contact.

Solder the longer power/data strip first

(For tips on soldering, be sure to check out our [Guide to Excellent Soldering \(\)](#)).

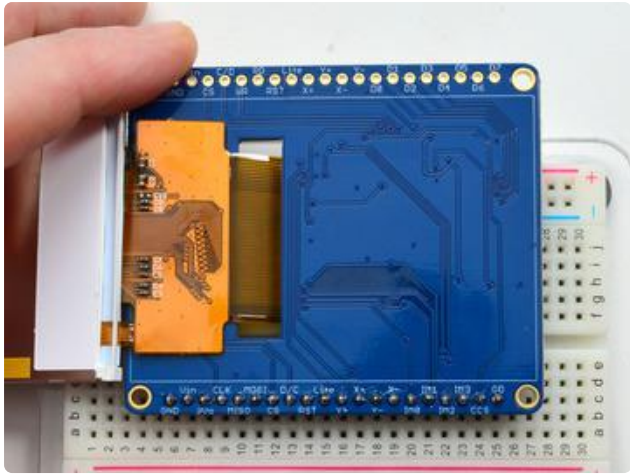

You're done! Check your solder joints visually

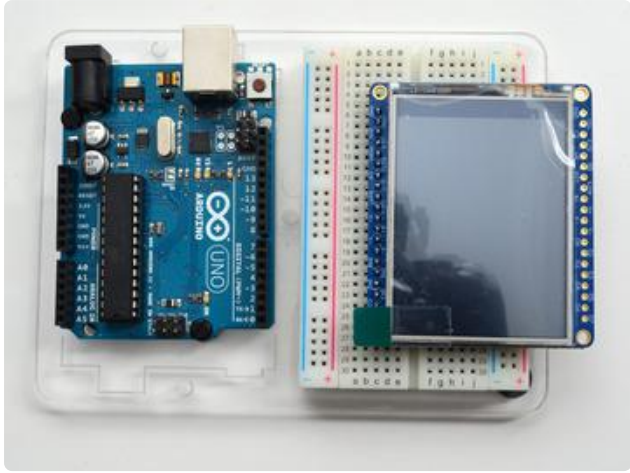

If your display isn't taped down to the breakout PCB, peel off the tape covering and press down so the TFT sticks to the circuit board

Wiring & Test

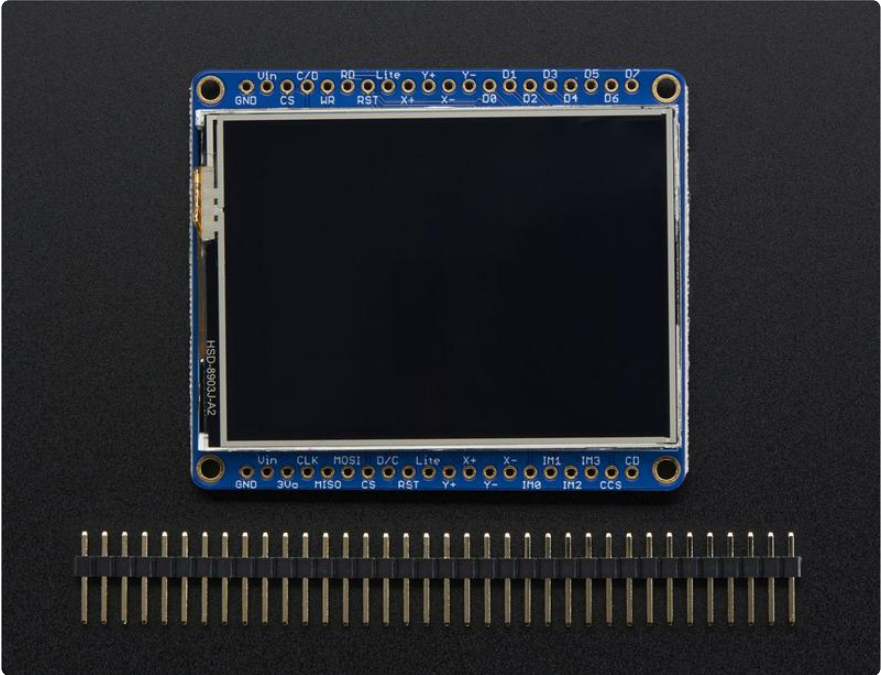

We tried to make this TFT breakout useful for both high-pin microcontrollers that can handle 8-bit data transfer modes as well as low-pincount micros like the Arduino UNO and Leonardo that are OK with SPI.

Essentially, the tradeoff is pins for speed. SPI is about 2-4 times slower than 8-bit mode, but that may not matter for basic graphics!

In addition, SPI mode has the benefit of being able to use the onboard microSD card socket for reading images. We don't have support for this in 8-bit mode so if you want to have an all-in-one image viewer type application, use SPI!

8-Bit Wiring & Test

8-Bit Wiring

Wiring up the 8-bit mode is kind of a pain, so we really only recommend doing it for UNO (which we show) and Mega (which we describe, and is pretty easy since its 8 pins in a row). Anything else, like a Leonardo or Micro, we strongly recommend going with SPI mode since we don't have an example for that. Any other kind of 'Arduino compatible' that isn't an Uno, try SPI first. The 8-bit mode is hand-tweaked in the Adafruit_TFTLCD pin_magic.h file. Its really only for advanced users who are totally cool with figuring out bitmasks for various ports & pins.

Really, we'll show how to do the UNO but anything else? go with SPI!

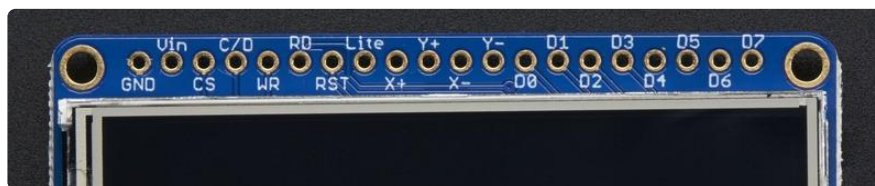

Make sure you're soldering and connecting to the 8-bit side!

Part 1 - Power & backlight test

Begin by wiring up the 3-5VDC and GND pins.

Connect the 3-5V pin to 5V and GND to GND on your Arduino. I'm using the breadboard rails but you can also just wire directly.

Power it up and you should see the white backlight come on.

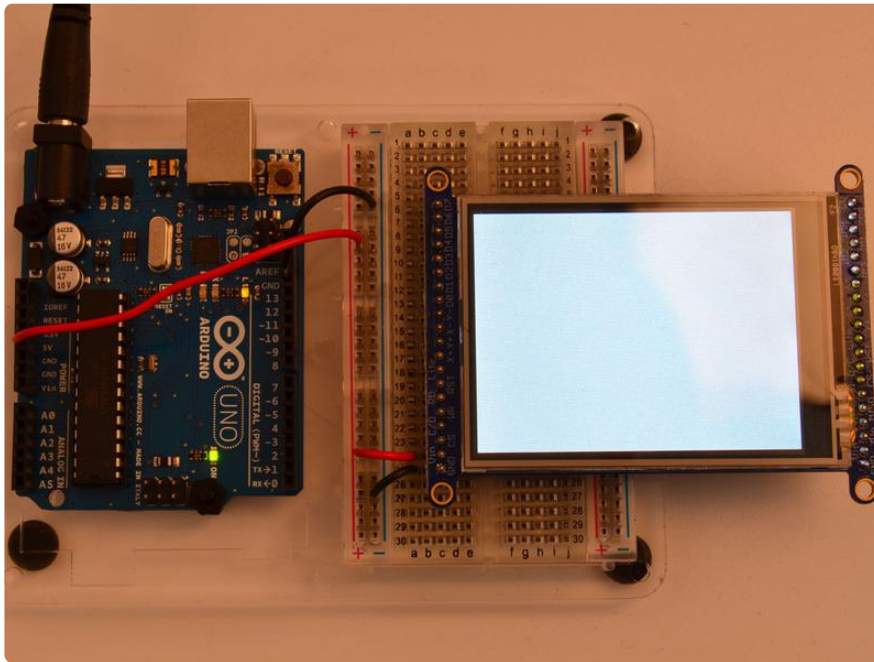

Part 2 - Data Bus Lines

Now that the backlight is working, we can get the TFT LCD working. There are many pins required, and to keep the code running fairly fast, we have 'hardcoded' Arduino digital pins #2-#9 for the 8 data lines.

However, they are not in that order! D0 and D1 go to digital #8 and #9, then D2-D7 connect to #2 thru #7. This is because Arduino pins #0 and #1 are used for serial data so we can't use them

Begin by connecting D0 and D1 to digital #8 and 9 respectively as seen above. If you're using a Mega, connect the TFT Data Pins D0-D1 to Mega pins #22-23, in that order. Those Mega pins are on the 'double' header.

Now you can connect the remaining 6 pins over. Connect D2-D7 on the TFT pins to digital 2 thru 7 in that order. If you're using a Mega, connect the TFT Data Pins D2-D7 to Mega pins #24-29, in that order. Those Mega pins are on the 'double' header.

In addition to the 8 data lines, you'll also need 4 or 5 control lines. These can later be reassigned to any digital pins, they're just what we have in the tutorial by default.

- Connect the third pin CS (Chip Select) to Analog 3
- Connect the fourth pin C/D (Command/Data) to Analog 2
- Connect the fifth pin WR (Write) to Analog 1

- Connect the sixth pin RD (Read) to Analog 0

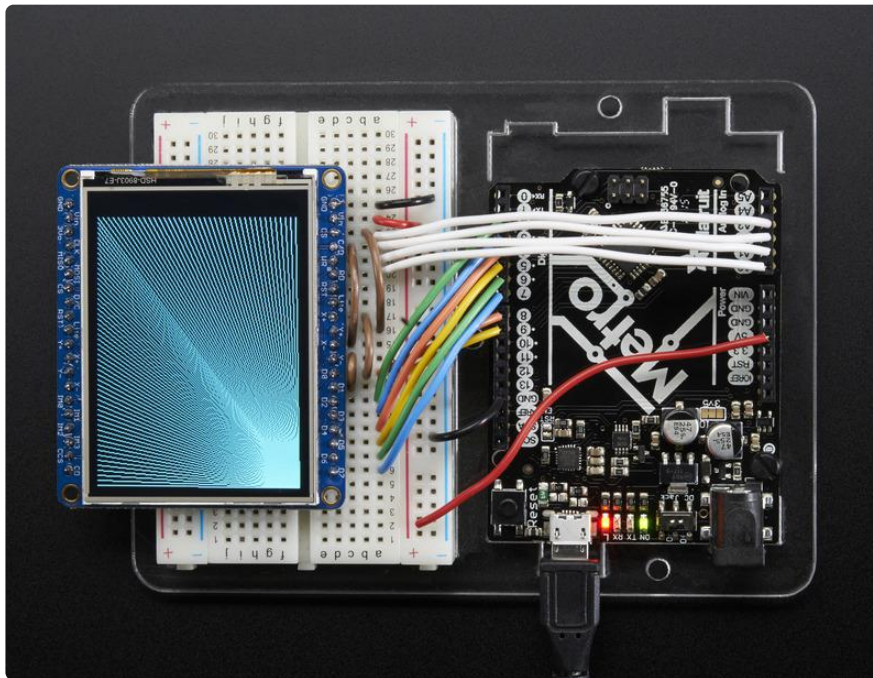

You can connect the seventh pin RST (Reset) to the Arduino Reset line if you'd like. This will reset the panel when the Arduino is Reset. You can also use a digital pin for the LCD reset if you want to manually reset. There's auto-reset circuitry on the board so you probably don't need to use this pin at all and leave it disconnected

The RD pin is used to read the chip ID off the TFT. Later, once you get it all working, you can remove this pin and the ID test, although we suggest keeping it since its useful for debugging your wiring. OK! Now we can run some code

8-Bit Library Install

We have example code ready to go for use with these TFTs. It's written for Arduino, which should be portable to any microcontroller by adapting the C++ source.

Two libraries need to be downloaded and installed: the [TFTLCD library \(\)](#) and the [GFX library. \(\)](#) You can install these libraries through the Arduino library manager.

Open up the Arduino library manager:

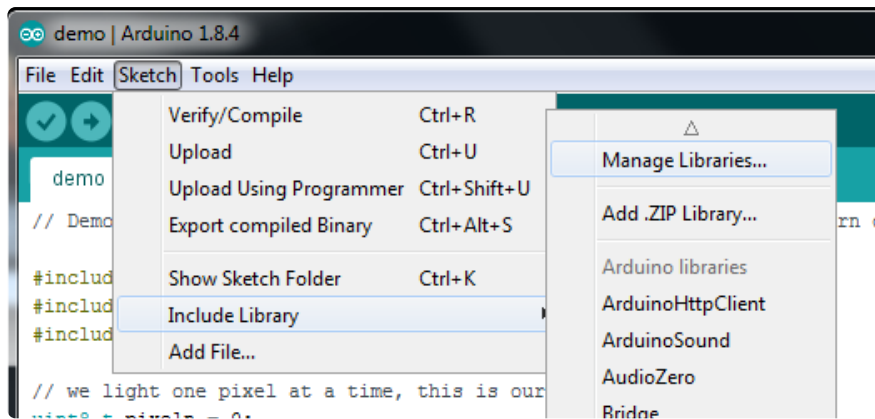

Search for the Adafruit GFX library and install it:

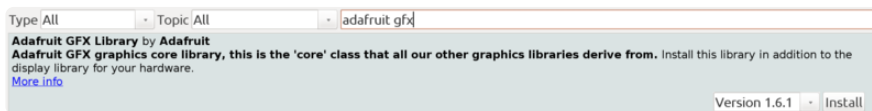

If using an older Arduino IDE (pre-1.8.10), do the same for Adafruit_BusIO (newer versions do this one automatically).

Then search for the Adafruit TFTLCD library and install it:



We also have a great tutorial on Arduino library installation at:

<http://learn.adafruit.com/adafruit-all-about-arduino-libraries-install-use> ()

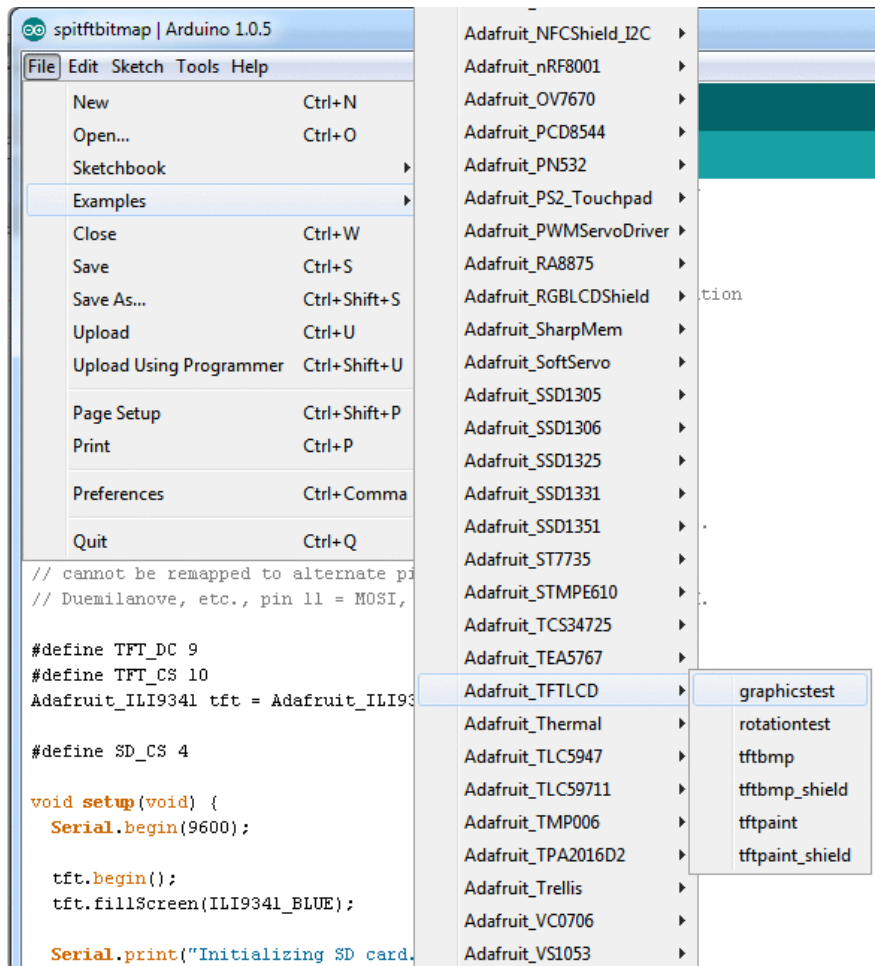

After restarting the Arduino software, you should see a new example folder called Ad afruit_TFTLCD and inside, an example called graphicstest. Upload that sketch to your Arduino. You may need to press the Reset button to reset the arduino and TFT. You should see a collection of graphical tests draw out on the TFT.

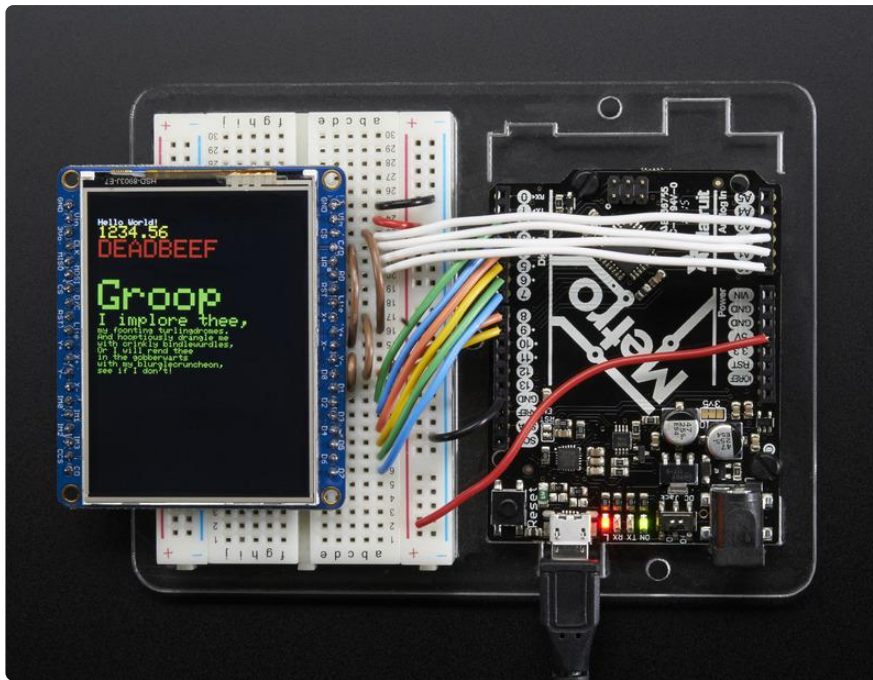

If you're having difficulties, check the serial console. The first thing the sketch does is read the driver code from the TFT. It should be 0x9341 (for the ILI9341 controller inside)

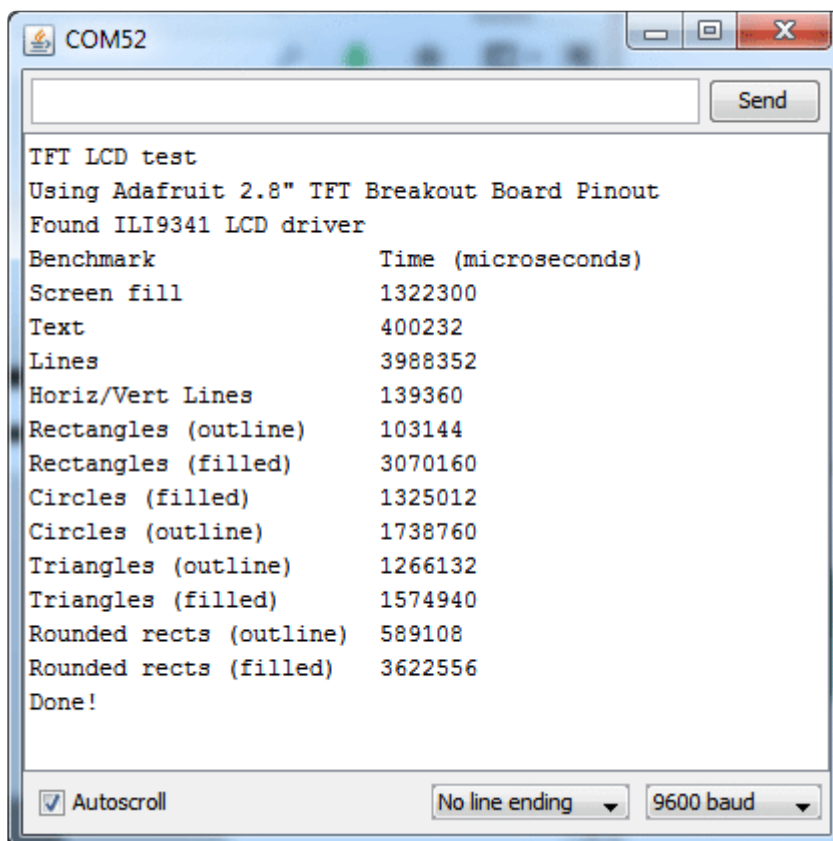

If you Unknown Driver Chip then it's probably something with your wiring, double check and try again!

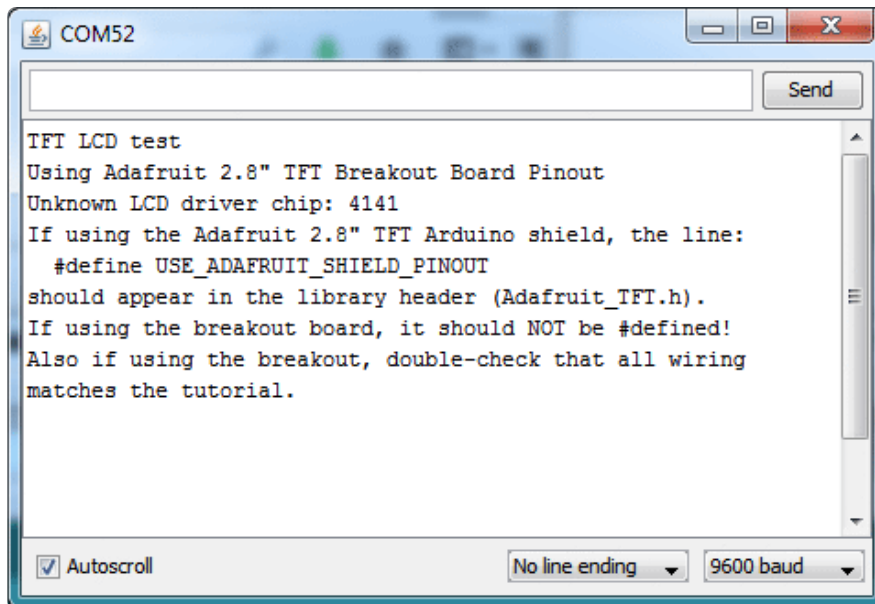

SPI Wiring & Test



Don't forget, we're using the SPI interface side of the PCB!

SPI Mode Jumpers

Before you start, we'll need to tell the display to put us in SPI mode so it will know which pins to listen to. To do that, we have to connect the IM1, IM2 and IM3 pins to 3.3V. The easiest way to do that is to solder closed the IMx jumpers on the back of the PCB. Turn over the PCB and find the solder jumpers

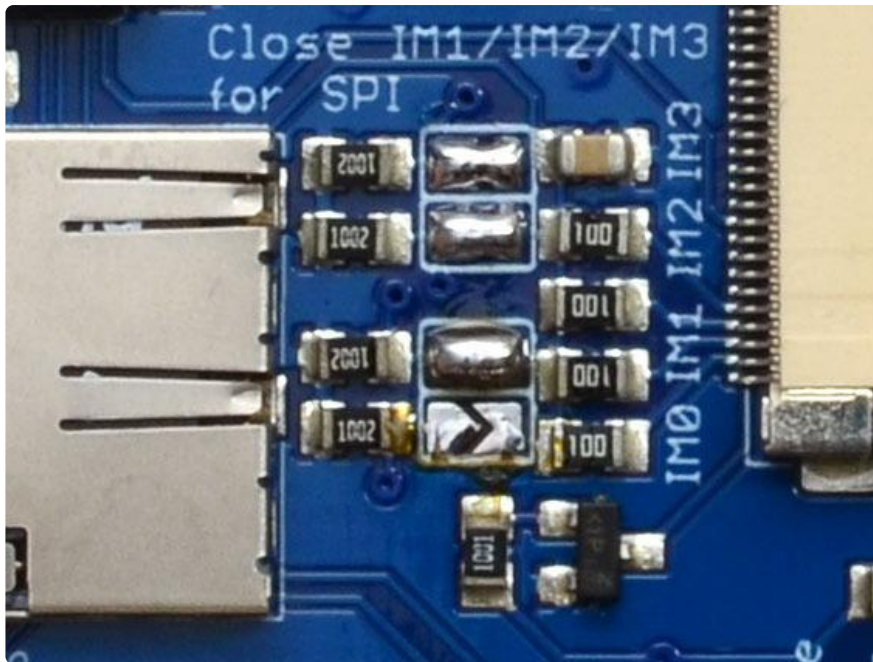

With your soldering iron, melt solder to close the three jumpers indicated IM1 IM2 and IM3 (do not solder closed IM0!)

If you really don't want to solder them, you can also wire the breakout pins to the 3v0 pin, just make sure you don't tie them to 5V by accident! For that reason, we suggest going with the solder-jumper route.

Wiring

Wiring up the display in SPI mode is much easier than 8-bit mode since there's way fewer wires. Start by connecting the power pins

- 3-5V Vin connects to the Arduino 5V pin
- GND connects to Arduino ground
- CLK connects to SPI clock. On Arduino Uno/Duemilanove/328-based, that's Digital 13. On Mega's, it's Digital 52 and on Leonardo/Due it's ICSP-3 ([See SPI Connections for more details \(\)](#))
- MISO connects to SPI MISO. On Arduino Uno/Duemilanove/328-based, that's Digital 12. On Mega's, it's Digital 50 and on Leonardo/Due it's ICSP-1 ([See SPI Connections for more details \(\)](#))
- MOSI connects to SPI MOSI. On Arduino Uno/Duemilanove/328-based, that's Digital 11. On Mega's, it's Digital 51 and on Leonardo/Due it's ICSP-4 ([See SPI Connections for more details \(\)](#))
- CS connects to our SPI Chip Select pin. We'll be using Digital 10 but you can later change this to any pin

- D/C connects to our SPI data/command select pin. We'll be using Digital 9 but you can later change this pin too.

That's it! You do not need to connect the RST or other pins for now.

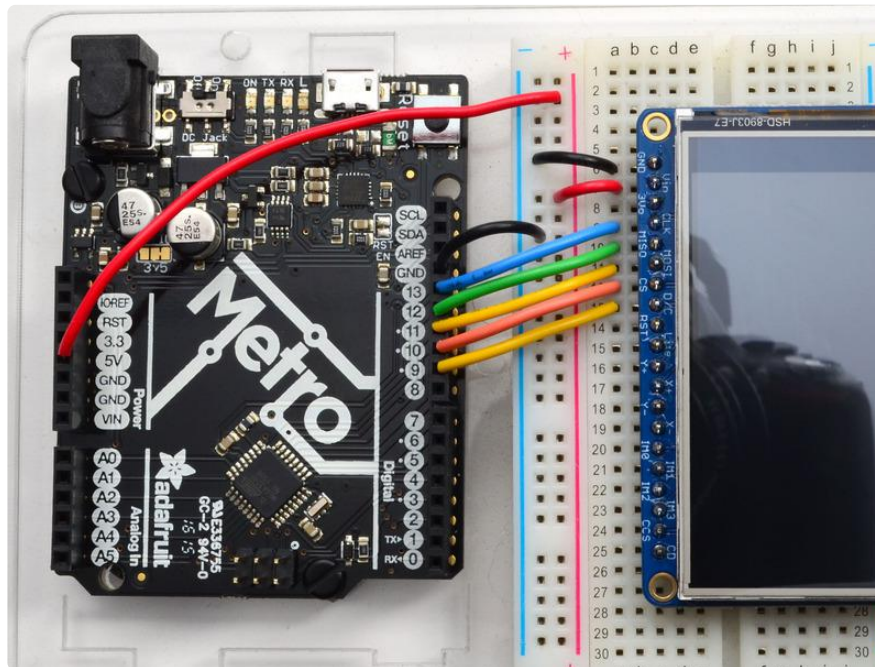

Install Libraries

You'll need a few libraries to use this display

From within the Arduino IDE, open up the Library Manager...

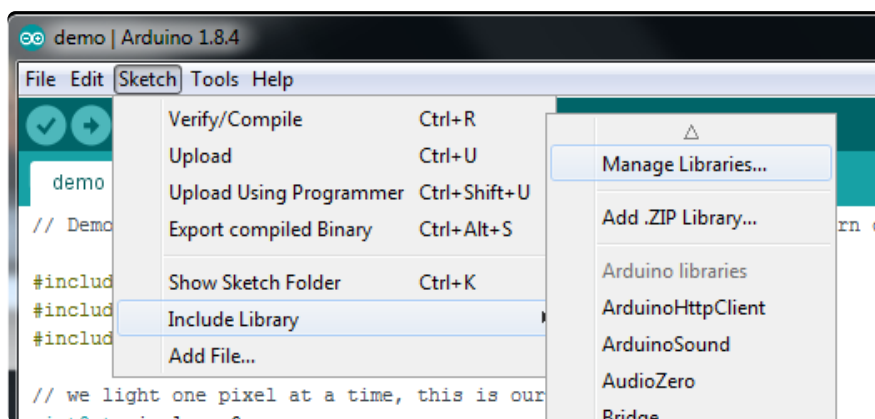

Install Libraries

We have example code ready to go for use with these TFTs.

Two libraries need to be downloaded and installed: first is the [Adafruit ILI9341 library](#) () (this contains the low-level code specific to this device), and second is the [Adafruit GFX Library](#) () (which handles graphics operations common to many displays we carry). If you have Adafruit_GFX already, make sure its the most recent version since we've made updates for better performance

Search for ILI9341 and install the Adafruit ILI9341 library that pops up!

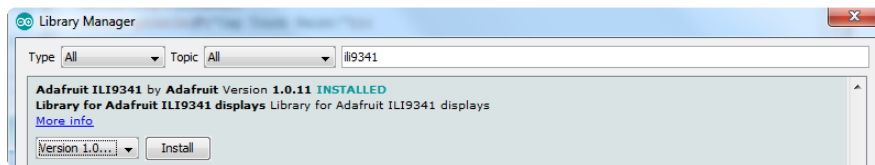

For more details, especially for first-time library installers, [check out our great tutorial at http://learn.adafruit.com/adafruit-all-about-arduino-libraries-install-use](http://learn.adafruit.com/adafruit-all-about-arduino-libraries-install-use) ()

Next up, search for Adafruit GFX and locate the core library. A lot of libraries may pop up because we reference it in the description so just make sure you see Adafruit GFX Library in bold at the top.

Install it!

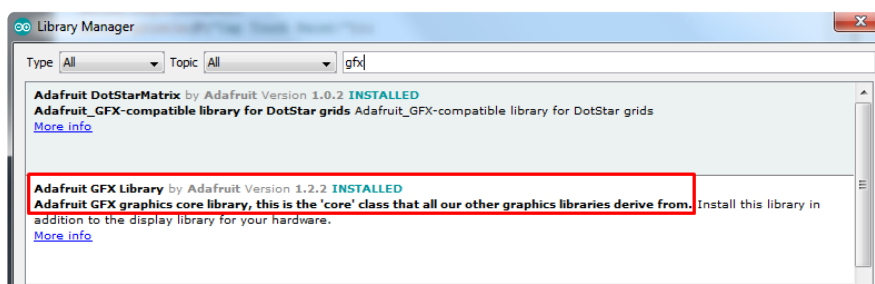

If using an older Arduino IDE (pre-1.8.10), do the same for Adafruit_BusIO (newer versions do this one automatically).

After restarting the Arduino software, you should see a new example folder called Adafuit_ILI9341 and inside, an example called graphicstest. Upload that sketch to your Arduino. You may need to press the Reset button to reset the arduino and TFT. You should see a collection of graphical tests draw out on the TFT.

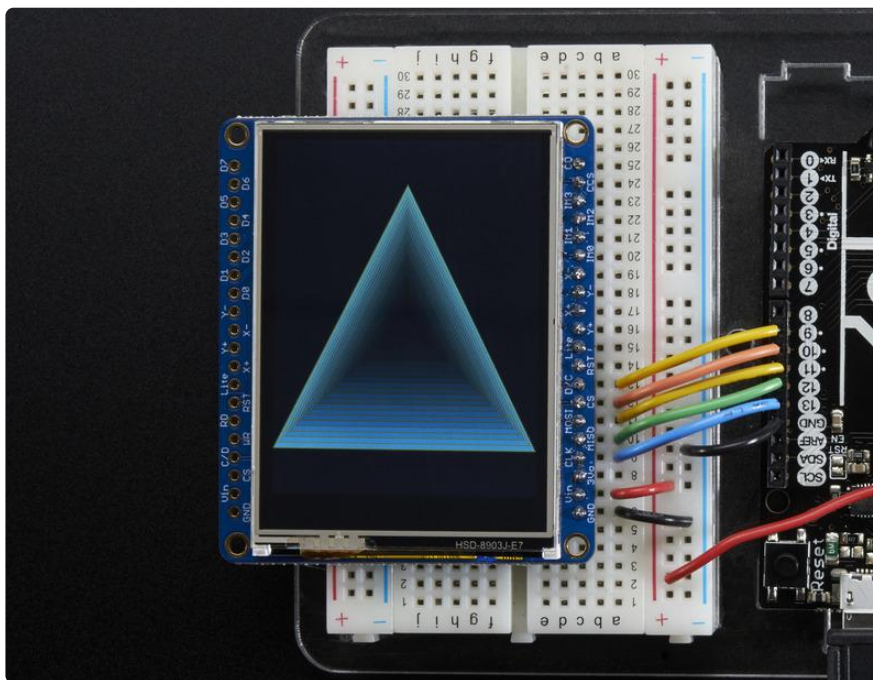
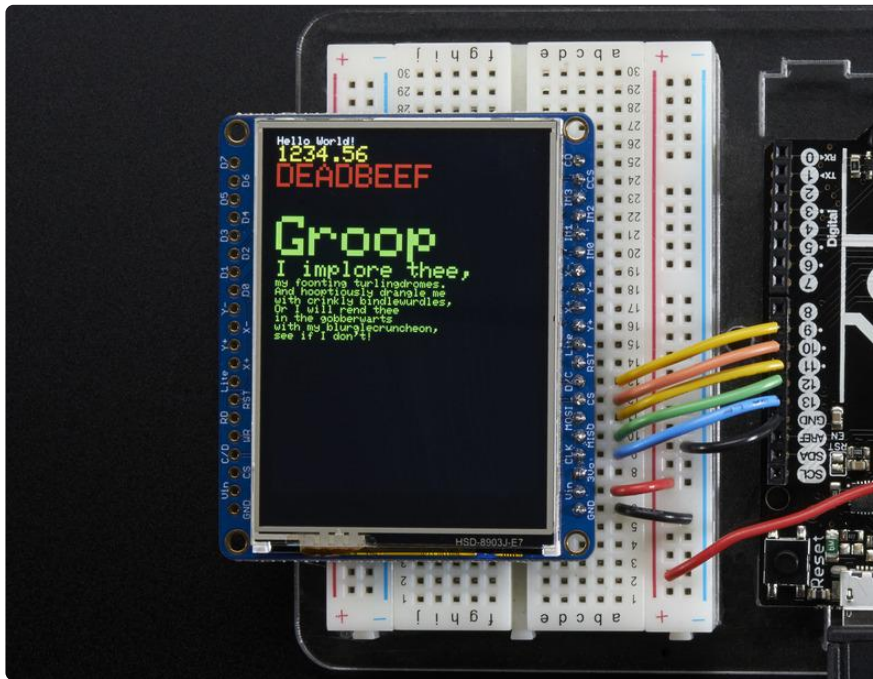
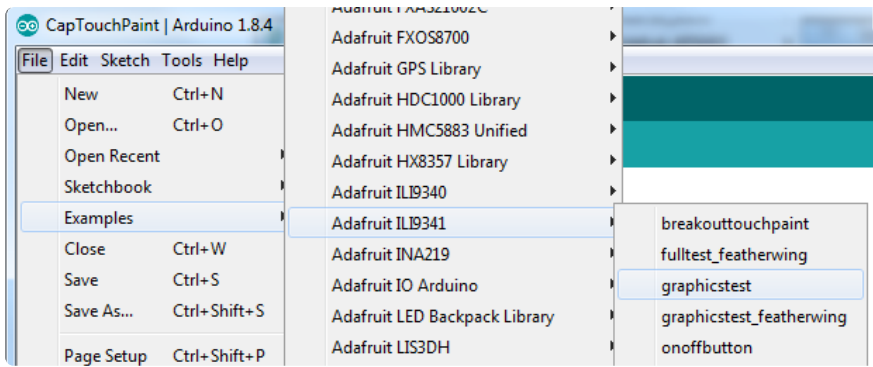

If you're having difficulties, check the serial console. The first thing the sketch does is read the driver configuration from the TFT, you should see the same numbers as

below

If you did not connect up the MISO line to the TFT, you won't see the read configuration bytes so please make sure you connect up the MISO line for easy debugging! Once it's all working, you can remove the MISO line

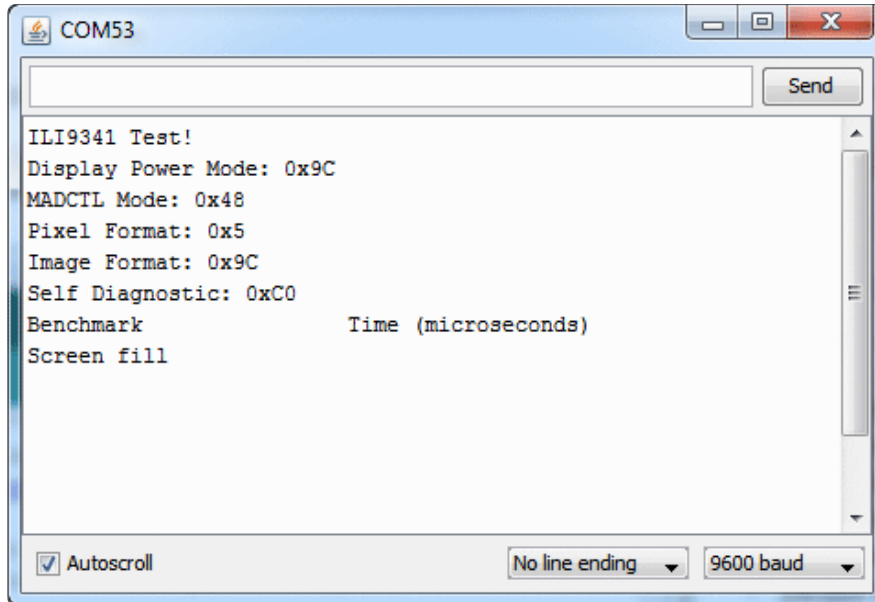

Bitmaps (SPI Mode)

There is a built in microSD card slot into the breakout, and we can use that to load bitmap images! You will need a microSD card formatted FAT16 or FAT32 (they almost always are by default).

It's really easy to draw bitmaps. However, this is only supported when talking to the display in SPI mode, not 8-bit mode!

It's really easy to draw bitmaps. We have a library for it, `Adafruit_ImageReader`, which can be installed through the Arduino Library Manager (Sketch→Include Library→Manage Libraries...). Enter "imageread" in the search field and the library is easy to spot:

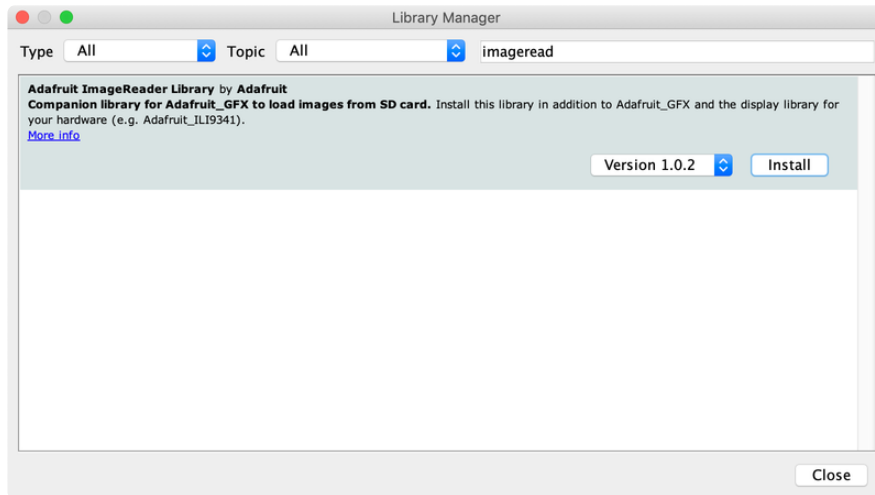

Lets start by downloading this image of pretty flowers



Copy purple.bmp into the base directory of a microSD card and insert it into the microSD socket in the breakout.

You'll need to connect up the CCS pin to Digital 4 on your Arduino as well. In the below image, its the extra brown wire

You may want to try the SD library examples before continuing, especially one that lists all the files on the SD card

Now upload the File→examples→Adafruit ImageReader Library→ShieldILI9341 example to your Arduino + breakout. You will see the flowers appear!

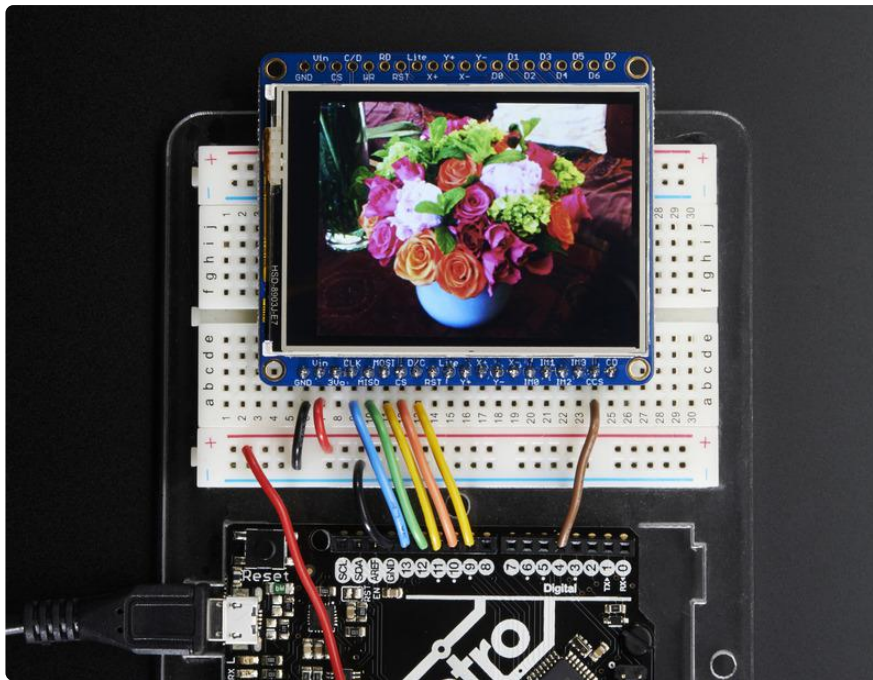

Adafruit GFX Library

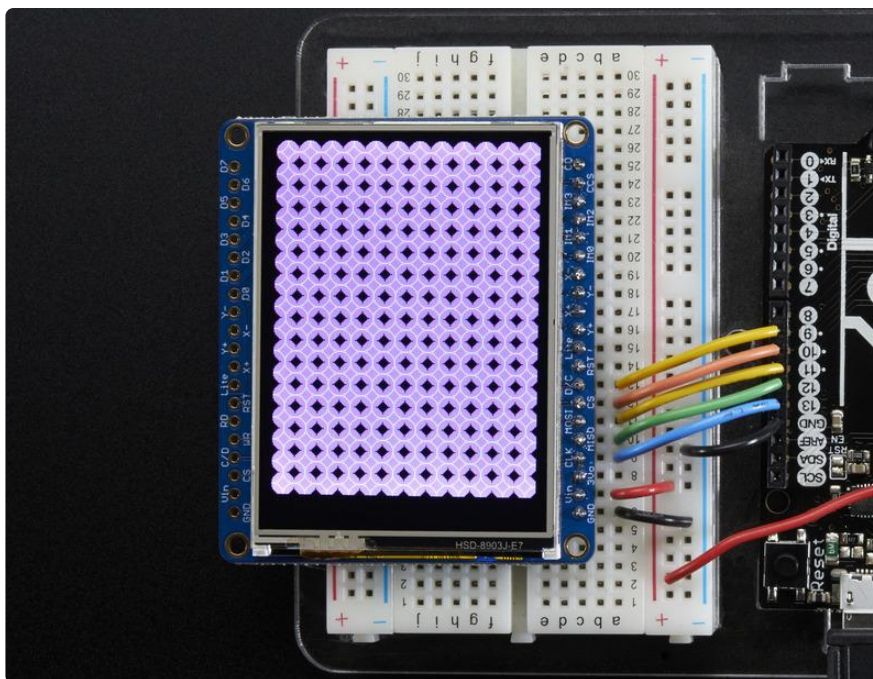

The Adafruit_GFX library for Arduino provides a common syntax and set of graphics functions for all of our TFT, LCD and OLED displays. This allows Arduino sketches to easily be adapted between display types with minimal fuss...and any new features, performance improvements and bug fixes will immediately apply across our complete offering of color displays.

The GFX library is what lets you draw points, lines, rectangles, round-rects, triangles, text, etc.

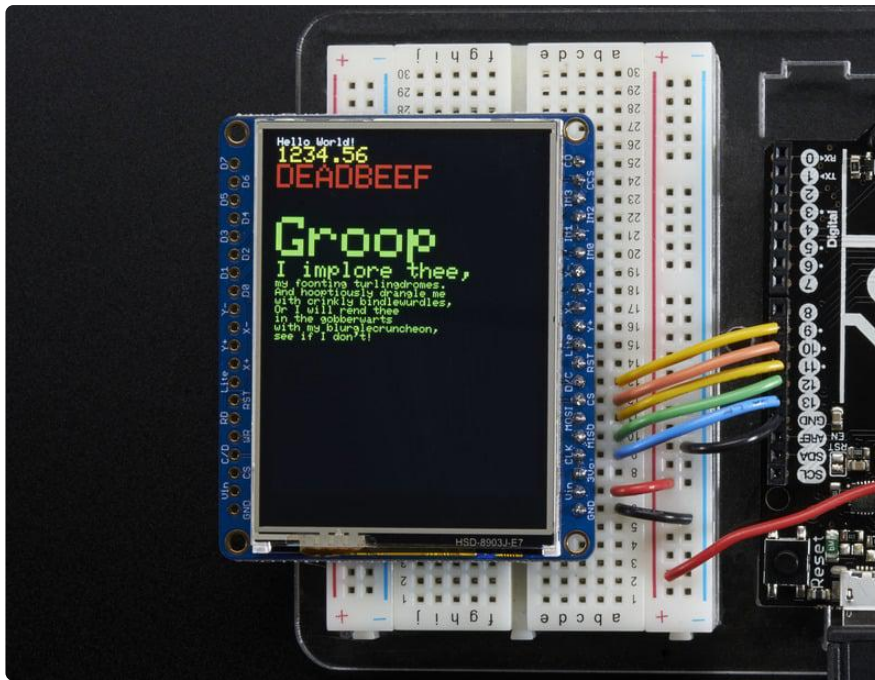

Check out our detailed tutorial here <http://learn.adafruit.com/adafruit-gfx-graphics-library/>

It covers the latest and greatest of the GFX library. The GFX library is used in both 8-bit and SPI modes so the underlying commands (`drawLine()` for example) are identical!

Resistive Touchscreen

The LCD has a 2.8" 4-wire resistive touch screen glued onto it. You can use this for detecting finger-presses, stylus', etc. You'll need 4 pins to talk to the touch panel, and at least 2 must be analog inputs. The touch screen is a completely separate part from the TFT, so be aware if you rotate the display or have the TFT off or reset, the touch screen doesn't "know" about it - its just a couple resistors!

We have a demo for the touchscreen + TFT that lets you 'paint' simple graphics. There's versions for both SPI and 8-bit mode and are included in the libraries. Just make sure you have gone thru the TFT test procedure already since this builds on that.

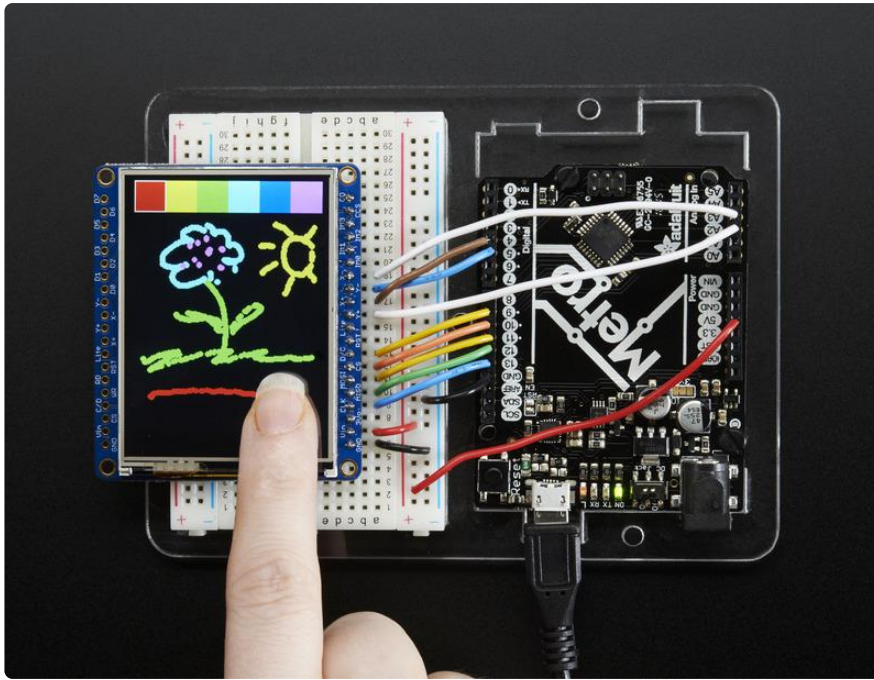

Remember, if you rotate the screen drawing with `setRotation()` you'll have to use `map()` or similar to flip around the X/Y coordinates for the touchscreen as well! It doesn't know about drawing rotation

Download Library

Begin by grabbing our [analog/resistive touchscreen library](#) () from the Arduino library manager.

Open up the Arduino library manager:

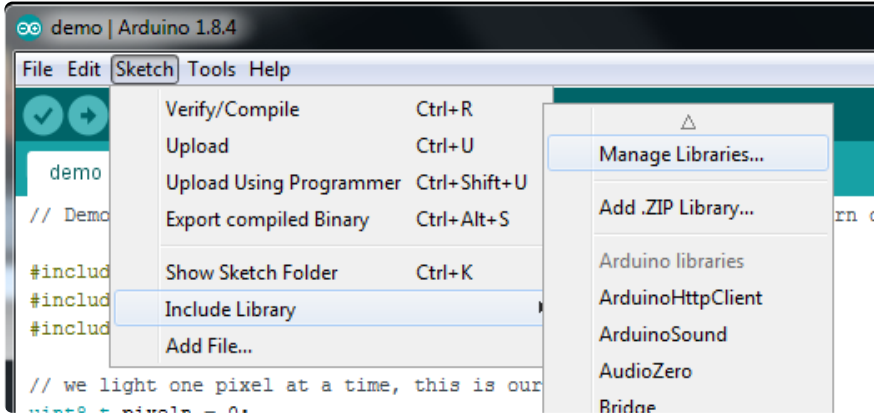

Search for the Adafruit TouchScreen library and install it



We also have a great tutorial on Arduino library installation at:
<http://learn.adafruit.com/adafruit-all-about-arduino-libraries-install-use> ()

Touchscreen Paint (SPI mode)

An additional 4 pins are required for the touchscreen. For the two analog pins, we'll use A2 and A3. For the other two connections, you can pin any two digital pins. We can save the one pin by sharing with D/C but you can't share any other SPI pins. So basically you can get away with using only three additional pins.

Wire the additional 4 pins as follows:

- Y+ to Arduino A2
- X+ to Arduino D4
- Y- to Arduino D5
- X- to Arduino A3

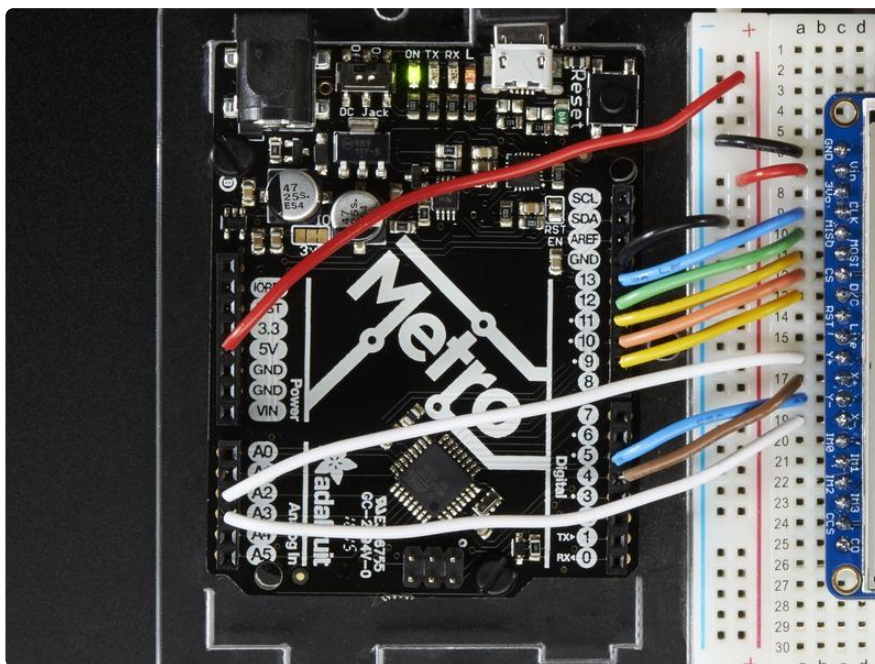

Load up the breakoutTouchPaint example from the Adafruit_ILI9341 library and try drawing with your fingernail! You can select colors by touching the 'palette' of colors on top

Touchscreen Paint (8-Bit mode)

Another 4 pins seems like a lot since already 12 are taken up with the TFT but you can

reuse some of the pins for the TFT LCD! This is because the resistance of the panel is high enough that it doesn't interfere with the digital input/output and we can query the panel in between TFT accesses, when the pins are not being used.

We'll be building on the wiring used in the previous drawing test for UNO

You can wire up the 4 touchscreen pins as follows. Starting from the top

- Y- connects to digital #9 (also D1)
- The next one down (X-) connects to Analog 2 (also C/D)
- The next one over (Y+) connects to Analog 3 (also CS)
- The last one (X+) connects to digital 8. (also D0)

The X- and Y+ pins pretty much have to connect to those analog pins (or to analog 4/5) but Y-/X+ can connect to any digital or analog pins.

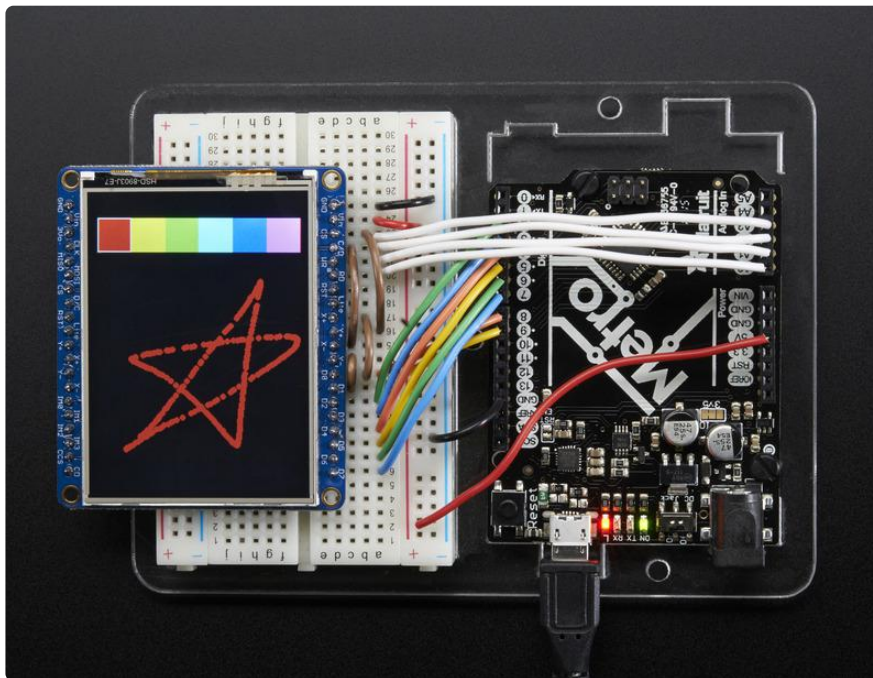

Load up the tftpaint example from the Adafruit_TFTLCD library and try drawing with your fingernail! You can select colors by touching the 'palette' of colors on the right

CircuitPython Displayio Quickstart

You will need a board capable of running CircuitPython such as the Metro M0 Express or the Metro M4 Express. You can also use boards such as the Feather M0 Express or the Feather M4 Express. We recommend either the Metro M4 or the Feather M4 Express because it's much faster and works better for driving a display. For this guide, we will be using a Feather M4 Express. The steps should be about the same for the

Feather M0 Express or either of the Metros. If you haven't already, be sure to check out our [Feather M4 Express \(\)](#) guide.

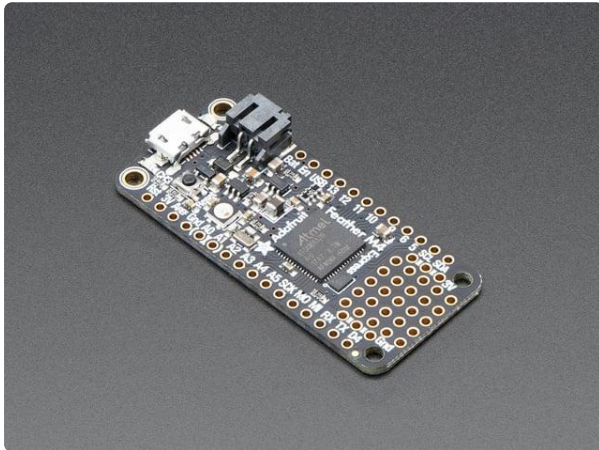

[Adafruit Feather M4 Express - Featuring ATSAM51](#)

It's what you've been waiting for, the Feather M4 Express featuring ATSAM51. This Feather is fast like a swift, smart like an owl, strong like a ox-bird (it's half ox,... <https://www.adafruit.com/product/3857>

For this guide, we'll assume you have a Feather M4 Express. The steps should be about the same for the Feather M0 Express. To start, if you haven't already done so, follow the assembly instructions for the Feather M4 Express in our [Feather M4 Express guide \(\)](#).

Preparing the Breakout

Before using the TFT Breakout, you will need to solder the headers or some wires to it. Be sure to check out the [Adafruit Guide To Excellent Soldering \(\)](#). Also, follow the SPI Wiring and Test page of this guide to be sure your display is setup for SPI. After that, the breakout should be ready to go.

Wiring the Breakout to the Feather

- 3-5V Vin connects to the Feather 3V pin
- GND connects to Feather ground
- CLK connects to SPI clock. On the Feather that's SCK.
- MISO connects to SPI MISO. On the Feather that's MI
- MOSI connects to SPI MOSI. On the Feather that's MO
- CS connects to our SPI Chip Select pin. We'll be using Digital 9 but you can later change this to any pin
- D/C connects to our SPI data/command select pin. We'll be using Digital 10 but you can later change this pin too.
- RST connects to our reset pin. We'll be using Digital 6 but you can later change this pin too.

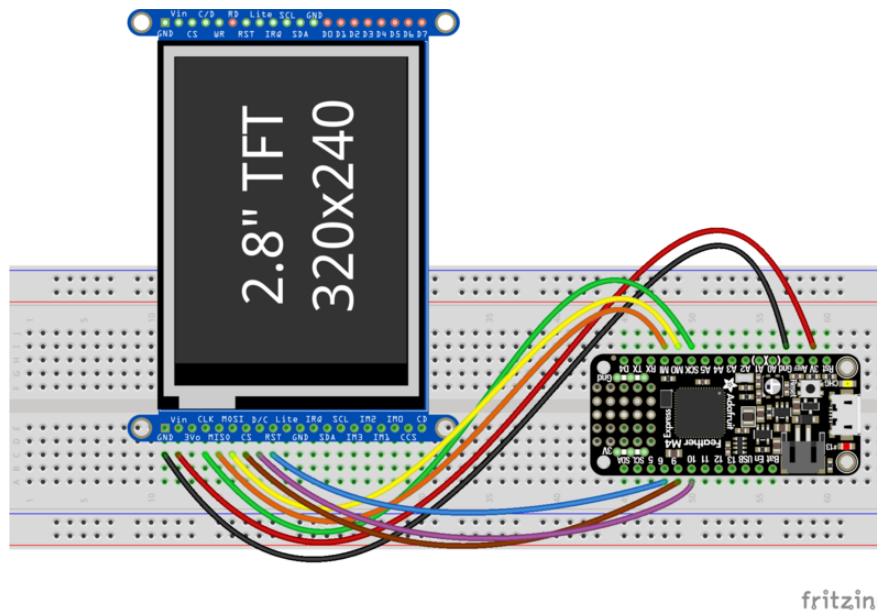

2.8-breakout-feather-m4.fzz

Required CircuitPython Libraries

To use this display with `displayio`, there is only one required library.

Adafruit_CircuitPython_ILI9341

First, make sure you are running the [latest version of Adafruit CircuitPython \(\)](#) for your board.

Next, you'll need to install the necessary libraries to use the hardware--carefully follow the steps to find and install these libraries from [Adafruit's CircuitPython library bundle \(\)](#). Our introduction guide has [a great page on how to install the library bundle \(\)](#) for both express and non-express boards.

Remember for non-express boards, you'll need to manually install the necessary libraries from the bundle:

- `adafruit_ili9341`

Before continuing make sure your board's lib folder or root filesystem has the `adafruit_ili9341` file copied over.

Code Example Additional Libraries

For the Code Example, you will need an additional library. We decided to make use of a library so the code didn't get overly complicated.

Adafruit_CircuitPython_Display_Text

Go ahead and install this in the same manner as the driver library by copying the `adafruit_display_text` folder over to the `lib` folder on your CircuitPython device.

CircuitPython Code Example

```
# SPDX-FileCopyrightText: 2021 ladyada for Adafruit Industries
# SPDX-License-Identifier: MIT

"""
This test will initialize the display using displayio and draw a solid green
background, a smaller purple rectangle, and some yellow text. All drawing is done
using native displayio modules.

Pinouts are for the 2.4" TFT FeatherWing or Breakout with a Feather M4 or M0.
"""
import board
import terminalio
import displayio
from adafruit_display_text import label
import adafruit_ili9341

# Release any resources currently in use for the displays
displayio.release_displays()

spi = board.SPI()
tft_cs = board.D9
tft_dc = board.D10

display_bus = displayio.FourWire(
    spi, command=tft_dc, chip_select=tft_cs, reset=board.D6
)
display = adafruit_ili9341.ILI9341(display_bus, width=320, height=240)

# Make the display context
splash = displayio.Group()
display.show(splash)

# Draw a green background
color_bitmap = displayio.Bitmap(320, 240, 1)
color_palette = displayio.Palette(1)
color_palette[0] = 0x00FF00 # Bright Green

bg_sprite = displayio.TileGrid(color_bitmap, pixel_shader=color_palette, x=0, y=0)

splash.append(bg_sprite)

# Draw a smaller inner rectangle
inner_bitmap = displayio.Bitmap(280, 200, 1)
inner_palette = displayio.Palette(1)
inner_palette[0] = 0xAA0088 # Purple
inner_sprite = displayio.TileGrid(inner_bitmap, pixel_shader=inner_palette, x=20,
```

```

y=20)
splash.append(inner_sprite)

# Draw a label
text_group = displayio.Group(scale=3, x=57, y=120)
text = "Hello World!"
text_area = label.Label(terminalio.FONT, text=text, color=0xFFFF00)
text_group.append(text_area) # Subgroup for text scaling
splash.append(text_group)

while True:
    pass

```

Code Details

Let's take a look at the sections of code one by one. We start by importing the board so that we can initialize `SPI`, `displayio`, `terminalio` for the font, a `label`, and the `adafruit_ili9341` driver.

```

import board
import displayio
import terminalio
from adafruit_display_text import label
import adafruit_ili9341

```

Next we release any previously used displays. This is important because if the Feather is reset, the display pins are not automatically released and this makes them available for use again.

```
displayio.release_displays()
```

Next, we set the SPI object to the board's SPI with the easy shortcut function `board.SPI()`. By using this function, it finds the SPI module and initializes using the default SPI parameters. Next we set the Chip Select and Data/Command pins that will be used.

```

spi = board.SPI()
tft_cs = board.D9
tft_dc = board.D10

```

In the next line, we set the display bus to FourWire which makes use of the SPI bus.

```
display_bus = displayio.FourWire(spi, command=tft_dc, chip_select=tft_cs,
reset=board.D6)
```

Finally, we initialize the driver with a width of 320 and a height of 240. If we stopped at this point and ran the code, we would have a terminal that we could type at and have the screen update.

```
display = adafruit_ili9341.ILI9341(display_bus, width=320, height=240)
```

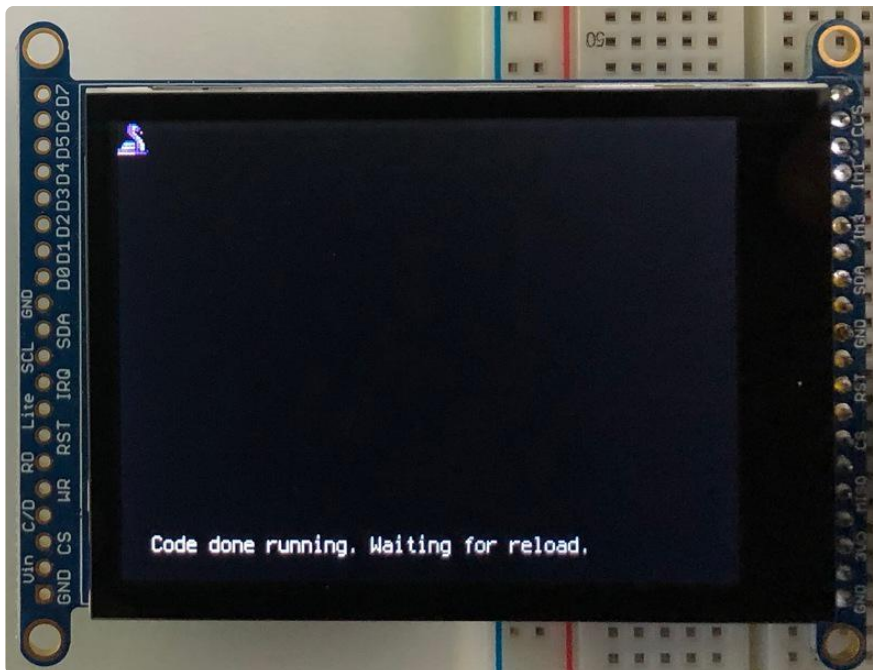

Next we create a background splash image. We do this by creating a group that we can add elements to and adding that group to the display. In this example, we are limiting the maximum number of elements to 10, but this can be increased if you would like. The display will automatically handle updating the group.

```
splash = displayio.Group(max_size=10)
display.show(splash)
```

Next we create a Bitmap which is like a canvas that we can draw on. In this case we are creating the Bitmap to be the same size as the screen, but only have one color. The Bitmaps can currently handle up to 256 different colors. We create a Palette with one color and set that color to 0x00FF00 which happens to be green. Colors are Hexadecimal values in the format of RRGGBB. Even though the Bitmaps can only handle 256 colors at a time, you get to define what those 256 different colors are.

```
color_bitmap = displayio.Bitmap(320, 240, 1)
color_palette = displayio.Palette(1)
color_palette[0] = 0x00FF00 # Bright Green
```

With all those pieces in place, we create a TileGrid by passing the bitmap and palette and draw it at (0, 0) which represents the display's upper left.

```
bg_sprite = displayio.TileGrid(color_bitmap,
                               pixel_shader=color_palette,
                               x=0, y=0)
splash.append(bg_sprite)
```

This creates a solid green background which we will draw on top of.



Next we will create a smaller purple rectangle. The easiest way to do this is the create a new bitmap that is a little smaller than the full screen with a single color and place it in a specific location. In this case we will create a bitmap that is 20 pixels smaller on each side. The screen is 320x240, so we'll want to subtract 40 from each of those numbers.

We'll also want to place it at the position `(20, 20)` so that it ends up centered.

```
inner_bitmap = displayio.Bitmap(280, 200, 1)
inner_palette = displayio.Palette(1)
inner_palette[0] = 0xAA0088 # Purple
inner_sprite = displayio.TileGrid(inner_bitmap,
                                  pixel_shader=inner_palette,
                                  x=20, y=20)
splash.append(inner_sprite)
```

Since we are adding this after the first rectangle, it's automatically drawn on top. Here's what it looks like now.

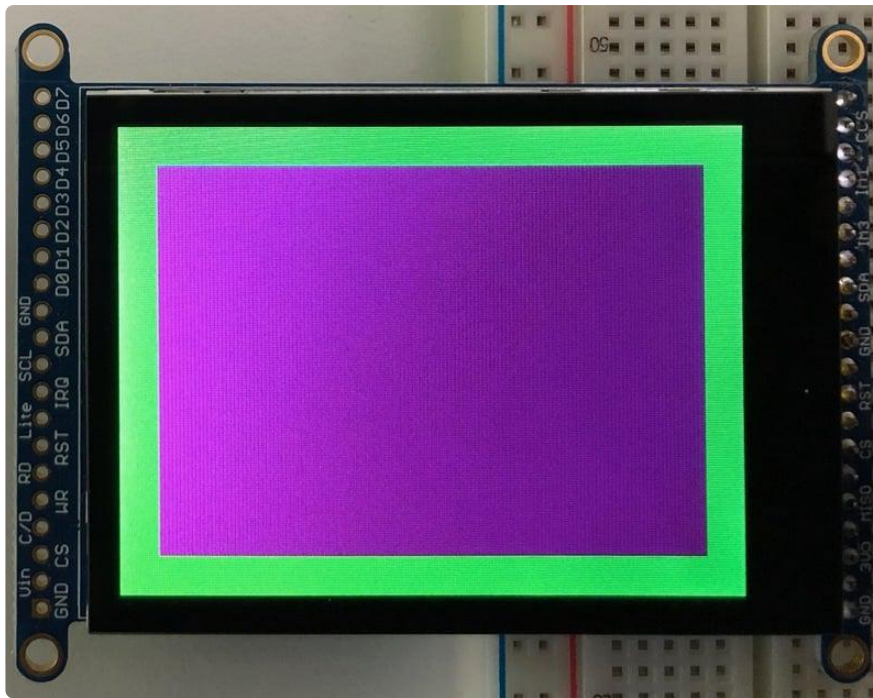

Next let's add a label that says "Hello World!" on top of that. We're going to use the built-in Terminal Font and scale it up by a factor of three. To scale the label only, we will make use of a subgroup, which we will then add to the main group.

Labels are centered vertically, so we'll place it at 120 for the Y coordinate, and around 57 pixels make it appear to be centered horizontally, but if you want to change the text, change this to whatever looks good to you. Let's go with some yellow text, so we'll pass it a value of `0xFFFF00`.

```
text_group = displayio.Group(max_size=10, scale=3, x=57, y=120)
text = "Hello World!"
text_area = label.Label(terminalio.FONT, text=text, color=0xFFFF00)
text_group.append(text_area) # Subgroup for text scaling
splash.append(text_group)
```

Finally, we place an infinite loop at the end so that the graphics screen remains in place and isn't replaced by a terminal.

```
while True:
    pass
```



Using Touch

We won't be covering how to use the touchscreen with CircuitPython in this guide, but the libraries required to use it are:

- For enabling capacitive touch use the [Adafruit_CircuitPython_FocalTouch \(\)](#) library.
- For enabling resistive touch use the [Adafruit_CircuitPython_STMPE610 \(\)](#) library.

Where to go from here

Be sure to check out this excellent [guide to CircuitPython Display Support Using displayio \(\)](#)

Python Wiring and Setup

Wiring

It's easy to use display breakouts with Python and the [Adafruit CircuitPython RGB Display \(\)](#) module. This module allows you to easily write Python code to control the display.

We'll cover how to wire the display to your Raspberry Pi. First assemble your display.

Since there's dozens of Linux computers/boards you can use we will show wiring for Raspberry Pi. For other platforms, [please visit the guide for CircuitPython on Linux to see whether your platform is supported \(\)](#).

Connect the display as shown below to your Raspberry Pi.

Note this is not a kernel driver that will let you have the console appear on the TFT. However, this is handy when you can't install an fbft driver, and want to use the TFT purely from 'user Python' code!

You can only use this technique with Linux/computer devices that have hardware SPI support, and not all single board computers have an SPI device so check before continuing

ILI9341 and HX-8357-based Displays

2.2" Display

- CLK connects to SPI clock. On the Raspberry Pi, that's SLCK
- MOSI connects to SPI MOSI. On the Raspberry Pi, that's also MOSI
- CS connects to our SPI Chip Select pin. We'll be using CE0
- D/C connects to our SPI Chip Select pin. We'll be using GPIO 25, but this can be changed later.
- RST connects to our Reset pin. We'll be using GPIO 24 but this can be changed later as well.
- Vin connects to the Raspberry Pi's 3V pin
- GND connects to the Raspberry Pi's ground

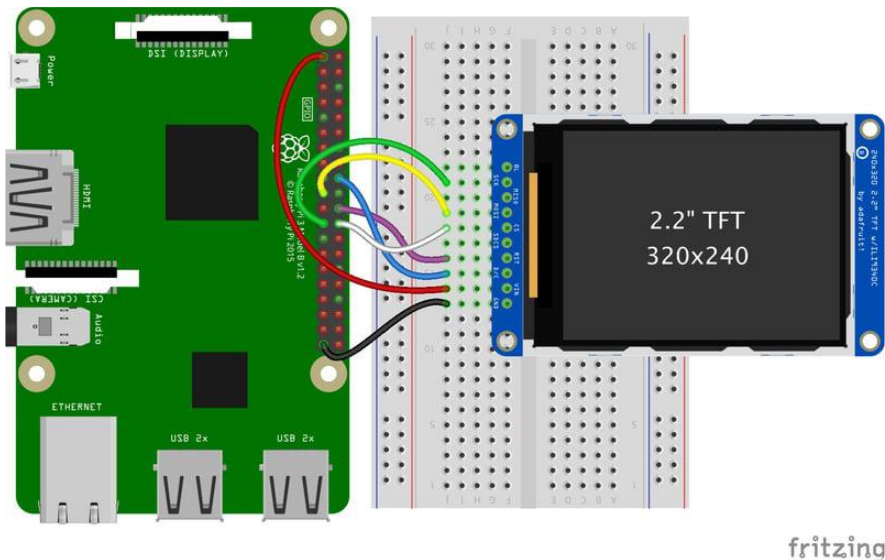

[Download the Fritzing Diagram](#)

2.4", 2.8", 3.2", and 3.5" Displays

These displays are set up to use the 8-bit data lines by default. We want to use them for SPI. To do that, you'll need to either solder bridge some pads on the back or connect the appropriate IM lines to 3.3V with jumper wires. Check the back of your display for the correct solder pads or IM lines to put it in SPI mode.

- Vin connects to the Raspberry Pi's 3V pin
- GND connects to the Raspberry Pi's ground
- CLK connects to SPI clock. On the Raspberry Pi, that's SLCK
- MOSI connects to SPI MOSI. On the Raspberry Pi, that's also MOSI
- CS connects to our SPI Chip Select pin. We'll be using CE0
- D/C connects to our SPI Chip Select pin. We'll be using GPIO 25, but this can be changed later.
- RST connects to our Reset pin. We'll be using GPIO 24 but this can be changed later as well.

These larger displays are set to use 8-bit data lines by default and may need to be modified to use SPI.

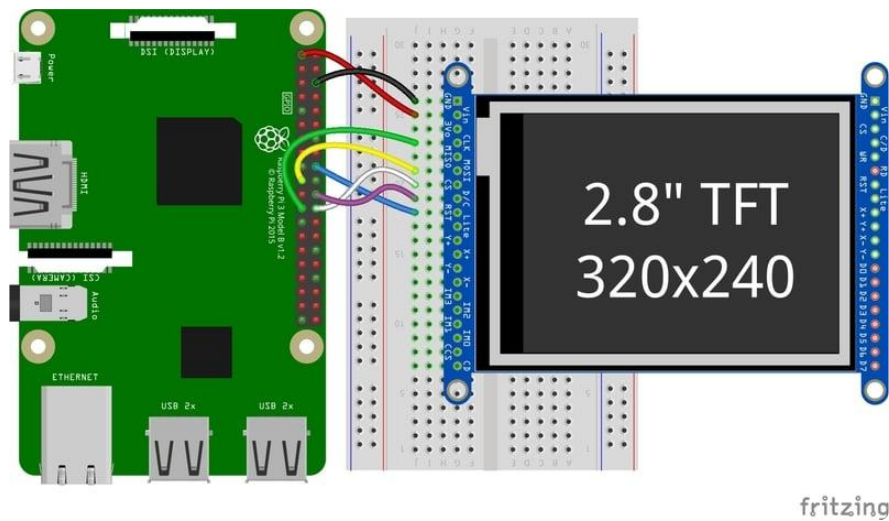

[Download the Fritzing Diagram](#)

ST7789 and ST7735-based Displays

1.3", 1.54", and 2.0" IPS TFT Display

- Vin connects to the Raspberry Pi's 3V pin
- GND connects to the Raspberry Pi's ground
- CLK connects to SPI clock. On the Raspberry Pi, that's SLCK
- MOSI connects to SPI MOSI. On the Raspberry Pi, that's also MOSI
- CS connects to our SPI Chip Select pin. We'll be using CE0
- RST connects to our Reset pin. We'll be using GPIO 24 but this can be changed later.
- D/C connects to our SPI Chip Select pin. We'll be using GPIO 25, but this can be changed later as well.

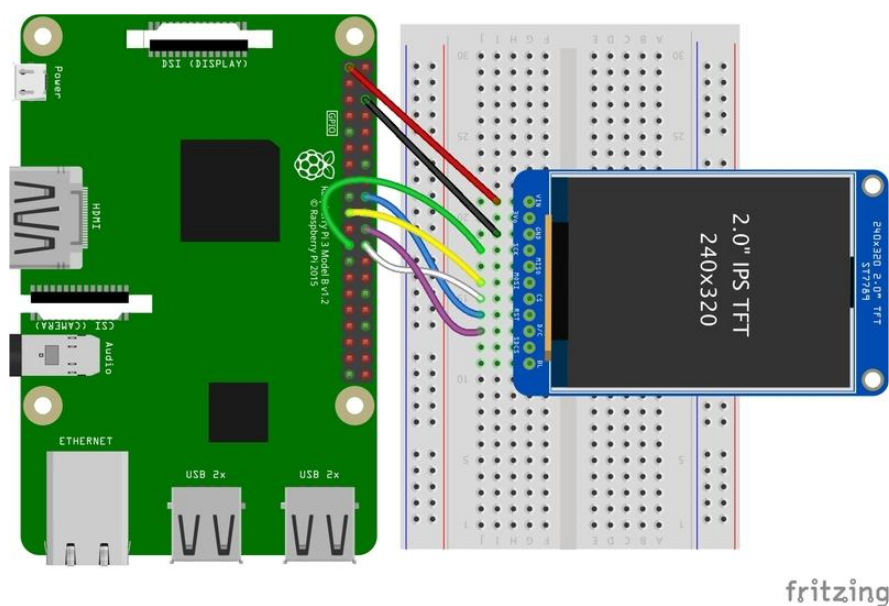

Download the Fritzing Diagram

0.96", 1.14", and 1.44" Displays

- Vin connects to the Raspberry Pi's 3V pin
- GND connects to the Raspberry Pi's ground
- CLK connects to SPI clock. On the Raspberry Pi, that's SLCK
- MOSI connects to SPI MOSI. On the Raspberry Pi, that's also MOSI
- CS connects to our SPI Chip Select pin. We'll be using CE0
- RST connects to our Reset pin. We'll be using GPIO 24 but this can be changed later.
- D/C connects to our SPI Chip Select pin. We'll be using GPIO 25, but this can be changed later as well.

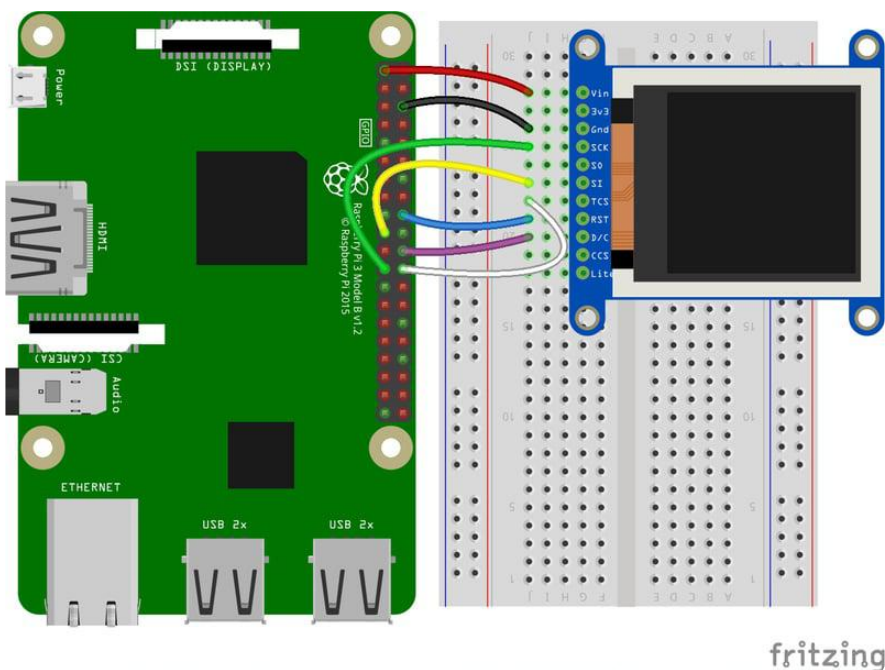

Download the Fritzing Diagram

1.8" Display

- GND connects to the Raspberry Pi's ground
- Vin connects to the Raspberry Pi's 3V pin
- RST connects to our Reset pin. We'll be using GPIO 24 but this can be changed later.
- D/C connects to our SPI Chip Select pin. We'll be using GPIO 25, but this can be changed later as well.
- CS connects to our SPI Chip Select pin. We'll be using CE0

- MOSI connects to SPI MOSI. On the Raspberry Pi, that's also MOSI
- CLK connects to SPI clock. On the Raspberry Pi, that's SLCK
- LITE connects to the Raspberry Pi's 3V pin. This can be used to separately control the backlight.

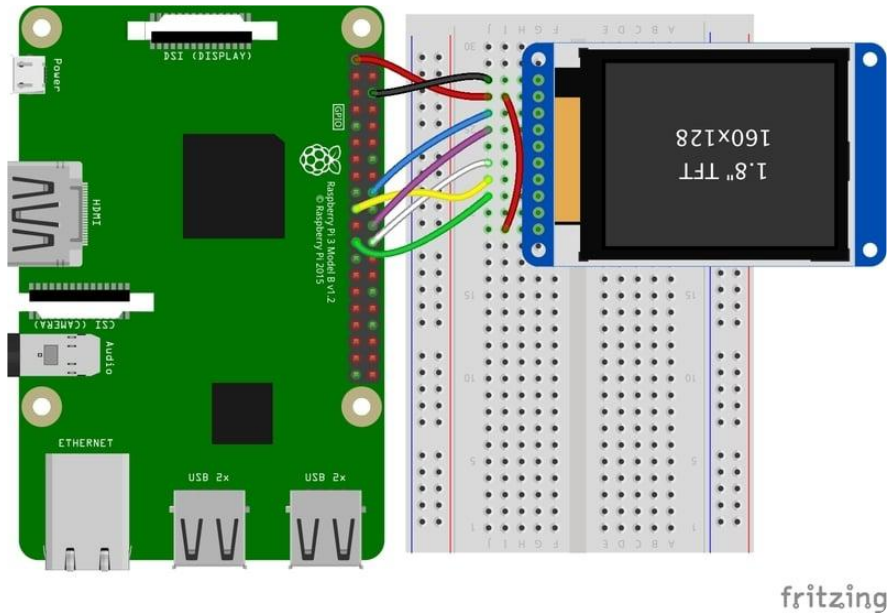

[Download the Fritzing Diagram](#)

SSD1351-based Displays

1.27" and 1.5" OLED Displays

- GND connects to the Raspberry Pi's ground
- Vin connects to the Raspberry Pi's 3V pin
- CLK connects to SPI clock. On the Raspberry Pi, that's SLCK
- MOSI connects to SPI MOSI. On the Raspberry Pi, that's also MOSI
- CS connects to our SPI Chip Select pin. We'll be using CE0
- RST connects to our Reset pin. We'll be using GPIO 24 but this can be changed later.
- D/C connects to our SPI Chip Select pin. We'll be using GPIO 25, but this can be changed later as well.

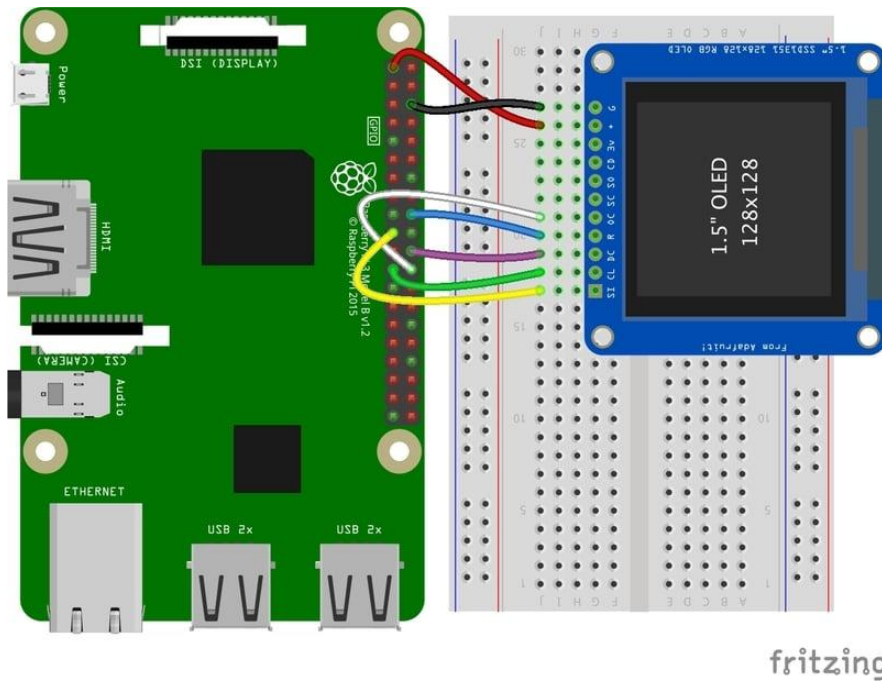

[Download the Fritzing Diagram](#)

SSD1331-based Display

0.96" OLED Display

- MOSI connects to SPI MOSI. On the Raspberry Pi, that's also MOSI
- CLK connects to SPI clock. On the Raspberry Pi, that's SLCK
- D/C connects to our SPI Chip Select pin. We'll be using GPIO 25, but this can be changed later.
- RST connects to our Reset pin. We'll be using GPIO 24 but this can be changed later as well.
- CS connects to our SPI Chip Select pin. We'll be using CE0
- Vin connects to the Raspberry Pi's 3V pin
- GND connects to the Raspberry Pi's ground

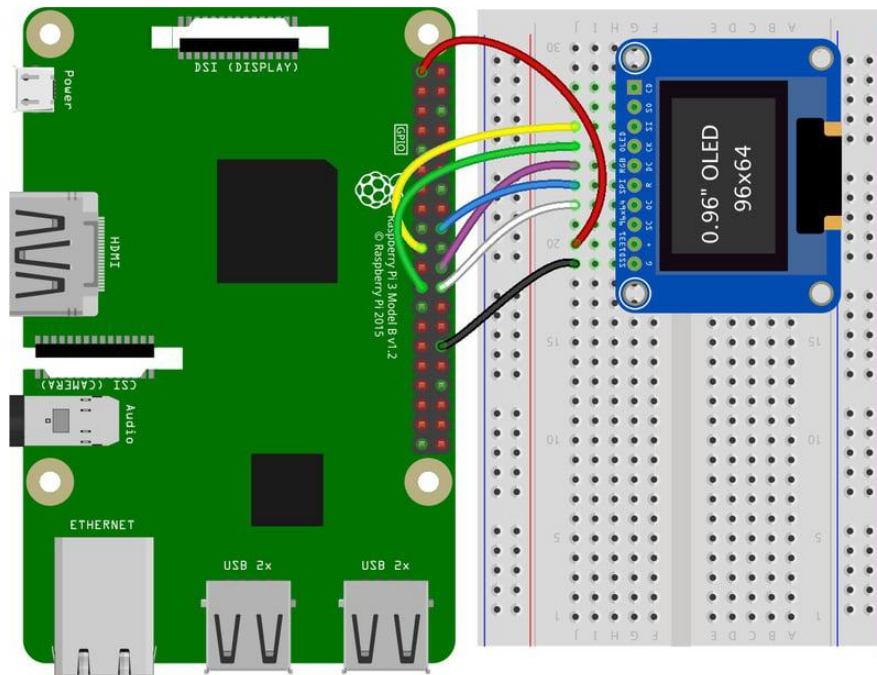

fritzing

Download the Fritzing Diagram

Setup

You'll need to install the Adafruit_Blinka library that provides the CircuitPython support in Python. This may also require enabling SPI on your platform and verifying you are running Python 3. [Since each platform is a little different, and Linux changes often, please visit the CircuitPython on Linux guide to get your computer ready \(!\)](#)

If you have previously installed the Kernel Driver with the PiTFT Easy Setup, you will need to remove it first in order to run this example.

Python Installation of RGB Display Library

Once that's done, from your command line run the following command:

- `sudo pip3 install adafruit-circuitpython-rgb-display`

If your default Python is version 3 you may need to run 'pip' instead. Just make sure you aren't trying to use CircuitPython on Python 2.x, it isn't supported!

If that complains about pip3 not being installed, then run this first to install it:

- `sudo apt-get install python3-pip`

DejaVu TTF Font

Raspberry Pi usually comes with the DejaVu font already installed, but in case it didn't, you can run the following to install it:

- `sudo apt-get install fonts-dejavu`

This package was previously calls ttf-dejavu, so if you are running an older version of Raspberry Pi OS, it may be called that.

Pillow Library

We also need PIL, the Python Imaging Library, to allow graphics and using text with custom fonts. There are several system libraries that PIL relies on, so installing via a package manager is the easiest way to bring in everything:

- `sudo apt-get install python3-pil`

If you installed the PIL through PIP, you may need to install some additional libraries:

- `sudo apt-get install libopenjp2-7 libtiff5 libatlas-base-dev`

That's it. You should be ready to go.

Python Usage

If you have previously installed the Kernel Driver with the PiTFT Easy Setup, you will need to remove it first in order to run this example.

Now that you have everything setup, we're going to look over three different examples. For the first, we'll take a look at automatically scaling and cropping an image and then centering it on the display.

Turning on the Backlight

On some displays, the backlight is controlled by a separate pin such as the 1.3" TFT Bonnet with Joystick. On such displays, running the below code will likely result in the display remaining black. To turn on the backlight, you will need to add a small snippet of code. If your backlight pin number differs, be sure to change it in the code:

```
# Turn on the Backlight
backlight = DigitalInOut(board.D26)
backlight.switch_to_output()
backlight.value = True
```

Displaying an Image

Here's the full code to the example. We will go through it section by section to help you better understand what is going on. Let's start by downloading an image of Blinky. This image has enough border to allow resizing and cropping with a variety of display sizes and rations to still look good.

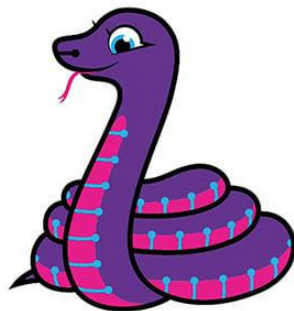

Make sure you save it as blinka.jpg and place it in the same folder as your script. Here's the code we'll be loading onto the Raspberry Pi. We'll go over the interesting parts.

```
# SPDX-FileCopyrightText: 2021 ladyada for Adafruit Industries
# SPDX-License-Identifier: MIT

"""
Be sure to check the learn guides for more usage information.

This example is for use on (Linux) computers that are using CPython with
Adafruit Blinka to support CircuitPython libraries. CircuitPython does
not support PIL/pillow (python imaging library)!

Author(s): Melissa LeBlanc-Williams for Adafruit Industries
```



```

"""

import digitalio
import board
from PIL import Image, ImageDraw
from adafruit_rgb_display import ili9341
from adafruit_rgb_display import st7789 # pylint: disable=unused-import
from adafruit_rgb_display import hx8357 # pylint: disable=unused-import
from adafruit_rgb_display import st7735 # pylint: disable=unused-import
from adafruit_rgb_display import ssd1351 # pylint: disable=unused-import
from adafruit_rgb_display import ssd1331 # pylint: disable=unused-import

# Configuration for CS and DC pins (these are PiTFT defaults):
cs_pin = digitalio.DigitalInOut(board.CE0)
dc_pin = digitalio.DigitalInOut(board.D25)
reset_pin = digitalio.DigitalInOut(board.D24)

# Config for display baudrate (default max is 24mhz):
BAUDRATE = 24000000

# Setup SPI bus using hardware SPI:
spi = board.SPI()

# pylint: disable=line-too-long
# Create the display:
# disp = st7789.ST7789(spi, rotation=90, # 2.0" ST7789
# disp = st7789.ST7789(spi, height=240, y_offset=80, rotation=180, # 1.3", 1.54"
ST7789
# disp = st7789.ST7789(spi, rotation=90, width=135, height=240, x_offset=53,
y_offset=40, # 1.14" ST7789
# disp = st7789.ST7789(spi, rotation=90, width=172, height=320, x_offset=34, #
1.47" ST7789
# disp = st7789.ST7789(spi, rotation=270, width=170, height=320, x_offset=35, #
1.9" ST7789
# disp = hx8357.HX8357(spi, rotation=180, # 3.5" HX8357
# disp = st7735.ST7735R(spi, rotation=90, # 1.8" ST7735R
# disp = st7735.ST7735R(spi, rotation=270, height=128, x_offset=2, y_offset=3, #
1.44" ST7735R
# disp = st7735.ST7735R(spi, rotation=90, bgr=True, width=80, # 0.96" MiniTFT
Rev A ST7735R
# disp = st7735.ST7735R(spi, rotation=90, invert=True, width=80, # 0.96" MiniTFT
Rev B ST7735R
# x_offset=26, y_offset=1,
# disp = ssd1351.SSD1351(spi, rotation=180, # 1.5" SSD1351
# disp = ssd1351.SSD1351(spi, height=96, y_offset=32, rotation=180, # 1.27" SSD1351
# disp = ssd1331.SSD1331(spi, rotation=180, # 0.96" SSD1331
disp = ili9341.ILI9341(
    spi,
    rotation=90, # 2.2", 2.4", 2.8", 3.2" ILI9341
    cs=cs_pin,
    dc=dc_pin,
    rst=reset_pin,
    baudrate=BAUDRATE,
)
# pylint: enable=line-too-long

# Create blank image for drawing.
# Make sure to create image with mode 'RGB' for full color.
if disp.rotation % 180 == 90:
    height = disp.width # we swap height/width to rotate it to landscape!
    width = disp.height
else:
    width = disp.width # we swap height/width to rotate it to landscape!
    height = disp.height
image = Image.new("RGB", (width, height))

# Get drawing object to draw on image.
draw = ImageDraw.Draw(image)

```

```

# Draw a black filled box to clear the image.
draw.rectangle((0, 0, width, height), outline=0, fill=(0, 0, 0))
disp.image(image)

image = Image.open("blinka.jpg")

# Scale the image to the smaller screen dimension
image_ratio = image.width / image.height
screen_ratio = width / height
if screen_ratio < image_ratio:
    scaled_width = image.width * height // image.height
    scaled_height = height
else:
    scaled_width = width
    scaled_height = image.height * width // image.width
image = image.resize((scaled_width, scaled_height), Image.BICUBIC)

# Crop and center the image
x = scaled_width // 2 - width // 2
y = scaled_height // 2 - height // 2
image = image.crop((x, y, x + width, y + height))

# Display image.
disp.image(image)

```

So we start with our usual imports including a couple of Pillow modules and the display drivers. That is followed by defining a few pins here. The reason we chose these is because they allow you to use the same code with the PiTFT if you chose to do so.

```

import digitalio
import board
from PIL import Image, ImageDraw
import adafruit_rgb_display.ili9341 as ili9341
import adafruit_rgb_display.st7789 as st7789
import adafruit_rgb_display.hx8357 as hx8357
import adafruit_rgb_display.st7735 as st7735
import adafruit_rgb_display.ssd1351 as ssd1351
import adafruit_rgb_display.ssd1331 as ssd1331

# Configuration for CS and DC pins
cs_pin = digitalio.DigitalInOut(board.CE0)
dc_pin = digitalio.DigitalInOut(board.D25)
reset_pin = digitalio.DigitalInOut(board.D24)

```

Next we'll set the baud rate from the default 24 MHz so that it works on a variety of displays. The exception to this is the SSD1351 driver, which will automatically limit it to 16MHz even if you pass 24MHz. We'll set up our SPI bus and then initialize the display.

We wanted to make these examples work on as many displays as possible with very few changes. The ILI9341 display is selected by default. For other displays, go ahead and comment out these lines:

```

disp = ili9341.ILI9341(
    spi,
    rotation=90, # 2.2", 2.4", 2.8", 3.2" ILI9341

```

and uncomment the line appropriate for your display and possibly the line below in the case of longer initialization sequences. The displays have a rotation property so that it can be set in just one place.

```
#disp = st7789.ST7789(spi, rotation=90, # 2.0" ST7789
#disp = st7789.ST7789(spi, height=240, y_offset=80, rotation=180, # 1.3", 1.54"
ST7789
#disp = st7789.ST7789(spi, rotation=90, width=135, height=240, x_offset=53,
y_offset=40, # 1.14" ST7789
#disp = hx8357.HX8357(spi, rotation=180, # 3.5" HX8357
#disp = st7735.ST7735R(spi, rotation=90, # 1.8" ST7735R
#disp = st7735.ST7735R(spi, rotation=270, height=128, x_offset=2, y_offset=3, #
1.44" ST7735R
#disp = st7735.ST7735R(spi, rotation=90, bgr=True, width=80, # 0.96" MiniTFT
Rev A ST7735R
#disp = st7735.ST7735R(spi, rotation=90, invert=True, width=80, # 0.96" MiniTFT
Rev B ST7735R
#x_offset=26, y_offset=1,#disp = ssd1351.SSD1351(spi,
rotation=180, # 1.5" SSD1351
#disp = ssd1351.SSD1351(spi, height=96, y_offset=32, rotation=180, # 1.27" SSD1351
#disp = ssd1331.SSD1331(spi, rotation=180, # 0.96" SSD1331
disp = ili9341.ILI9341(
    spi,
    rotation=90, # 2.2", 2.4", 2.8", 3.2" ILI9341
    cs=cs_pin,
    dc=dc_pin,
    rst=reset_pin,
    baudrate=BAUDRATE
)
```

Next we read the current rotation setting of the display and if it is 90 or 270 degrees, we need to swap the width and height for our calculations, otherwise we just grab the width and height. We will create an `image` with our dimensions and use that to create a `draw` object. The `draw` object will have all of our drawing functions.

```
# Create blank image for drawing.
# Make sure to create image with mode 'RGB' for full color.
if disp.rotation % 180 == 90:
    height = disp.width # we swap height/width to rotate it to landscape!
    width = disp.height
else:
    width = disp.width # we swap height/width to rotate it to landscape!
    height = disp.height
image = Image.new('RGB', (width, height))

# Get drawing object to draw on image.
draw = ImageDraw.Draw(image)
```

Next we clear whatever is on the screen by drawing a black rectangle. This isn't strictly necessary since it will be overwritten by the image, but it kind of sets the stage.

```
# Draw a black filled box to clear the image.
draw.rectangle((0, 0, width, height), outline=0, fill=(0, 0, 0))
disp.image(image)
```

Next we open the Blinka image, which we've named blinka.jpg, which assumes it is in the same directory that you are running the script from. Feel free to change it if it doesn't match your configuration.

```
image = Image.open("blinka.jpg")
```

Here's where it starts to get interesting. We want to scale the image so that it matches either the width or height of the display, depending on which is smaller, so that we have some of the image to chop off when we crop it. So we start by calculating the width to height ration of both the display and the image. If the height is the closer of the dimensions, we want to match the image height to the display height and let it be a bit wider than the display. Otherwise, we want to do the opposite.

Once we've figured out how we're going to scale it, we pass in the new dimensions and using a Bicubic rescaling method, we reassign the newly rescaled image back to `image`. Pillow has quite a few different methods to choose from, but Bicubic does a great job and is reasonably fast.

```
# Scale the image to the smaller screen dimension
image_ratio = image.width / image.height
screen_ratio = width / height
if screen_ratio < image_ratio:
    scaled_width = image.width * height // image.height
    scaled_height = height
else:
    scaled_width = width
    scaled_height = image.height * width // image.width
image = image.resize((scaled_width, scaled_height), Image.BICUBIC)
```

Next we want to figure the starting x and y points of the image where we want to begin cropping it so that it ends up centered. We do that by using a standard centering function, which is basically requesting the difference of the center of the display and the center of the image. Just like with scaling, we replace the `image` variable with the newly cropped image.

```
# Crop and center the image
x = scaled_width // 2 - width // 2
y = scaled_height // 2 - height // 2
image = image.crop((x, y, x + width, y + height))
```

Finally, we take our image and display it. At this point, the image should have the exact same dimensions at the display and fill it completely.

```
disp.image(image)
```



Drawing Shapes and Text

In the next example, we'll take a look at drawing shapes and text. This is very similar to the displayio example, but it uses Pillow instead. Here's the code for that.

```
# SPDX-FileCopyrightText: 2021 ladyada for Adafruit Industries
# SPDX-License-Identifier: MIT

"""
This demo will draw a few rectangles onto the screen along with some text
on top of that.

This example is for use on (Linux) computers that are using CPython with
Adafruit Blinka to support CircuitPython libraries. CircuitPython does
not support PIL/pillow (python imaging library)!

Author(s): Melissa LeBlanc-Williams for Adafruit Industries
"""

import digitalio
import board
from PIL import Image, ImageDraw, ImageFont
from adafruit_rgb_display import ili9341
from adafruit_rgb_display import st7789 # pylint: disable=unused-import
from adafruit_rgb_display import hx8357 # pylint: disable=unused-import
from adafruit_rgb_display import st7735 # pylint: disable=unused-import
from adafruit_rgb_display import ssd1351 # pylint: disable=unused-import
from adafruit_rgb_display import ssd1331 # pylint: disable=unused-import

# First define some constants to allow easy resizing of shapes.
BORDER = 20
FONTSIZE = 24

# Configuration for CS and DC pins (these are PiTFT defaults):
cs_pin = digitalio.DigitalInOut(board.CE0)
dc_pin = digitalio.DigitalInOut(board.D25)
reset_pin = digitalio.DigitalInOut(board.D24)

# Config for display baudrate (default max is 24mhz):
```

```

BAUDRATE = 24000000

# Setup SPI bus using hardware SPI:
spi = board.SPI()

# pylint: disable=line-too-long
# Create the display:
# disp = st7789.ST7789(spi, rotation=90, # 2.0" ST7789
# disp = st7789.ST7789(spi, height=240, y_offset=80, rotation=180, # 1.3", 1.54"
ST7789
# disp = st7789.ST7789(spi, rotation=90, width=135, height=240, x_offset=53,
y_offset=40, # 1.14" ST7789
# disp = st7789.ST7789(spi, rotation=90, width=172, height=320, x_offset=34, #
1.47" ST7789
# disp = st7789.ST7789(spi, rotation=270, width=170, height=320, x_offset=35, #
1.9" ST7789
# disp = hx8357.HX8357(spi, rotation=180, # 3.5" HX8357
# disp = st7735.ST7735R(spi, rotation=90, # 1.8" ST7735R
# disp = st7735.ST7735R(spi, rotation=270, height=128, x_offset=2, y_offset=3, #
1.44" ST7735R
# disp = st7735.ST7735R(spi, rotation=90, bgr=True, width=80, # 0.96" MiniTFT
Rev A ST7735R
# disp = st7735.ST7735R(spi, rotation=90, invert=True, width=80, # 0.96" MiniTFT
Rev B ST7735R
# x_offset=26, y_offset=1,
# disp = ssd1351.SSD1351(spi, rotation=180, # 1.5" SSD1351
# disp = ssd1351.SSD1351(spi, height=96, y_offset=32, rotation=180, # 1.27" SSD1351
# disp = ssd1331.SSD1331(spi, rotation=180, # 0.96" SSD1331
disp = ili9341.ILI9341(
    spi,
    rotation=90, # 2.2", 2.4", 2.8", 3.2" ILI9341
    cs=cs_pin,
    dc=dc_pin,
    rst=reset_pin,
    baudrate=BAUDRATE,
)
# pylint: enable=line-too-long

# Create blank image for drawing.
# Make sure to create image with mode 'RGB' for full color.
if disp.rotation % 180 == 90:
    height = disp.width # we swap height/width to rotate it to landscape!
    width = disp.height
else:
    width = disp.width # we swap height/width to rotate it to landscape!
    height = disp.height

image = Image.new("RGB", (width, height))

# Get drawing object to draw on image.
draw = ImageDraw.Draw(image)

# Draw a green filled box as the background
draw.rectangle((0, 0, width, height), fill=(0, 255, 0))
disp.image(image)

# Draw a smaller inner purple rectangle
draw.rectangle(
    (BORDER, BORDER, width - BORDER - 1, height - BORDER - 1), fill=(170, 0, 136)
)

# Load a TTF Font
font = ImageFont.truetype("/usr/share/fonts/truetype/dejavu/DejaVuSans.ttf",
    FONTSIZE)

# Draw Some Text
text = "Hello World!"
(font_width, font_height) = font.getsize(text)
draw.text(

```

```

        (width // 2 - font_width // 2, height // 2 - font_height // 2),
        text,
        font=font,
        fill=(255, 255, 0),
    )

# Display image.
disp.image(image)

```

Just like in the last example, we'll do our imports, but this time we're including the **ImageFont** Pillow module because we'll be drawing some text this time.

```

import digitalio
import board
from PIL import Image, ImageDraw, ImageFont
import adafruit_rgb_display.ili9341 as ili9341

```

Next we'll define some parameters that we can tweak for various displays. The **BORDER** will be the size in pixels of the green border between the edge of the display and the inner purple rectangle. The **FONTSIZE** will be the size of the font in points so that we can adjust it easily for different displays.

```

BORDER = 20
FONTSIZE = 24

```

Next, just like in the previous example, we will set up the display, setup the rotation, and create a draw object. If you have are using a different display than the ILI9341, go ahead and adjust your initializer as explained in the previous example. After that, we will setup the background with a green rectangle that takes up the full screen. To get green, we pass in a tuple that has our Red, Green, and Blue color values in it in that order which can be any integer from **0** to **255**.

```

draw.rectangle((0, 0, width, height), fill=(0, 255, 0))
disp.image(image)

```

Next we will draw an inner purple rectangle. This is the same color value as our example in displayio quickstart, except the hexadecimal values have been converted to decimal. We use the **BORDER** parameter to calculate the size and position that we want to draw the rectangle.

```

draw.rectangle((BORDER, BORDER, width - BORDER - 1, height - BORDER - 1),
               fill=(170, 0, 136))

```

Next we'll load a TTF font. The **DejaVuSans.ttf** font should come preloaded on your Pi in the location in the code. We also make use of the **FONTSIZE** parameter that we discussed earlier.

```
# Load a TTF Font
font = ImageFont.truetype('/usr/share/fonts/truetype/dejavu/DejaVuSans.ttf',
    FONTSIZE)
```

Now we draw the text Hello World onto the center of the display. You may recognize the centering calculation was the same one we used to center crop the image in the previous example. In this example though, we get the font size values using the `getsize()` function of the font object.

```
# Draw Some Text
text = "Hello World!"
(font_width, font_height) = font.getsize(text)
draw.text((width//2 - font_width//2, height//2 - font_height//2),
    text, font=font, fill=(255, 255, 0))
```

Finally, just like before, we display the image.

```
disp.image(image)
```



Displaying System Information

In this last example we'll take a look at getting the system information and displaying it. This can be very handy for system monitoring. Here's the code for that example:

```
# SPDX-FileCopyrightText: 2021 ladyada for Adafruit Industries
# SPDX-License-Identifier: MIT

"""
This will show some Linux Statistics on the attached display. Be sure to adjust
to the display you have connected. Be sure to check the learn guides for more
usage information.
```

This example is for use on (Linux) computers that are using CPython with Adafruit Blinka to support CircuitPython libraries. CircuitPython does not support PIL/pillow (python imaging library)!

```
"""
```

```
import time
import subprocess
import digitalio
import board
from PIL import Image, ImageDraw, ImageFont
from adafruit_rgb_display import ili9341
from adafruit_rgb_display import st7789 # pylint: disable=unused-import
from adafruit_rgb_display import hx8357 # pylint: disable=unused-import
from adafruit_rgb_display import st7735 # pylint: disable=unused-import
from adafruit_rgb_display import ssd1351 # pylint: disable=unused-import
from adafruit_rgb_display import ssd1331 # pylint: disable=unused-import

# Configuration for CS and DC pins (these are PiTFT defaults):
cs_pin = digitalio.DigitalInOut(board.CE0)
dc_pin = digitalio.DigitalInOut(board.D25)
reset_pin = digitalio.DigitalInOut(board.D24)

# Config for display baudrate (default max is 24mhz):
BAUDRATE = 24000000

# Setup SPI bus using hardware SPI:
spi = board.SPI()

# pylint: disable=line-too-long
# Create the display:
# disp = st7789.ST7789(spi, rotation=90, # 2.0" ST7789
# disp = st7789.ST7789(spi, height=240, y_offset=80, rotation=180, # 1.3", 1.54"
ST7789
# disp = st7789.ST7789(spi, rotation=90, width=135, height=240, x_offset=53,
y_offset=40, # 1.14" ST7789
# disp = st7789.ST7789(spi, rotation=90, width=172, height=320, x_offset=34, #
1.47" ST7789
# disp = st7789.ST7789(spi, rotation=270, width=170, height=320, x_offset=35, #
1.9" ST7789
# disp = hx8357.HX8357(spi, rotation=180, # 3.5" HX8357
# disp = st7735.ST7735R(spi, rotation=90, # 1.8" ST7735R
# disp = st7735.ST7735R(spi, rotation=270, height=128, x_offset=2, y_offset=3, #
1.44" ST7735R
# disp = st7735.ST7735R(spi, rotation=90, bgr=True, width=80, # 0.96" MiniTFT
Rev A ST7735R
# disp = st7735.ST7735R(spi, rotation=90, invert=True, width=80, # 0.96" MiniTFT
Rev B ST7735R
# x_offset=26, y_offset=1,
# disp = ssd1351.SSD1351(spi, rotation=180, # 1.5" SSD1351
# disp = ssd1351.SSD1351(spi, height=96, y_offset=32, rotation=180, # 1.27" SSD1351
# disp = ssd1331.SSD1331(spi, rotation=180, # 0.96" SSD1331
disp = ili9341.ILI9341(
    spi,
    rotation=90, # 2.2", 2.4", 2.8", 3.2" ILI9341
    cs=cs_pin,
    dc=dc_pin,
    rst=reset_pin,
    baudrate=BAUDRATE,
)
# pylint: enable=line-too-long

# Create blank image for drawing.
# Make sure to create image with mode 'RGB' for full color.
if disp.rotation % 180 == 90:
    height = disp.width # we swap height/width to rotate it to landscape!
    width = disp.height
else:
    width = disp.width # we swap height/width to rotate it to landscape!
```

```

    height = disp.height

image = Image.new("RGB", (width, height))

# Get drawing object to draw on image.
draw = ImageDraw.Draw(image)

# Draw a black filled box to clear the image.
draw.rectangle((0, 0, width, height), outline=0, fill=(0, 0, 0))
disp.image(image)

# First define some constants to allow easy positioning of text.
padding = -2
x = 0

# Load a TTF font. Make sure the .ttf font file is in the
# same directory as the python script!
# Some other nice fonts to try: http://www.dafont.com/bitmap.php
font = ImageFont.truetype("/usr/share/fonts/truetype/dejavu/DejaVuSans.ttf", 24)

while True:
    # Draw a black filled box to clear the image.
    draw.rectangle((0, 0, width, height), outline=0, fill=0)

    # Shell scripts for system monitoring from here:
    # https://unix.stackexchange.com/questions/119126/command-to-display-memory-
usage-disk-usage-and-cpu-load
    cmd = "hostname -I | cut -d' ' -f1"
    IP = "IP: " + subprocess.check_output(cmd, shell=True).decode("utf-8")
    cmd = "top -bn1 | grep load | awk '{printf \"CPU Load: %.2f\\\", $(NF-2)}'"
    CPU = subprocess.check_output(cmd, shell=True).decode("utf-8")
    cmd = "free -m | awk 'NR==2{printf \"Mem: %s/%s MB %.2f%\\\",
$3,$2,$3*100/$2 }'"
    MemUsage = subprocess.check_output(cmd, shell=True).decode("utf-8")
    cmd = 'df -h | awk \'$NF=="\/"{printf "Disk: %d/%d GB %s", $3,$2,$5}\''
    Disk = subprocess.check_output(cmd, shell=True).decode("utf-8")
    cmd = "cat /sys/class/thermal/thermal_zone0/temp | awk '{printf \"CPU Temp: %.
1f C\\\", $(NF-0) / 1000}'" # pylint: disable=line-too-long
    Temp = subprocess.check_output(cmd, shell=True).decode("utf-8")

    # Write four lines of text.
    y = padding
    draw.text((x, y), IP, font=font, fill="#FFFFFF")
    y += font.getsize(IP)[1]
    draw.text((x, y), CPU, font=font, fill="#FFFF00")
    y += font.getsize(CPU)[1]
    draw.text((x, y), MemUsage, font=font, fill="#00FF00")
    y += font.getsize(MemUsage)[1]
    draw.text((x, y), Disk, font=font, fill="#0000FF")
    y += font.getsize(Disk)[1]
    draw.text((x, y), Temp, font=font, fill="#FF00FF")

    # Display image.
    disp.image(image)
    time.sleep(0.1)

```

Just like the last example, we'll start by importing everything we imported, but we're adding two more imports. The first one is `time` so that we can add a small delay and the other is `subprocess` so we can gather some system information.

```

import time
import subprocess
import digitalio
import board

```

```
from PIL import Image, ImageDraw, ImageFont
import adafruit_rgb_display.ili9341 as ili9341
```

Next, just like in the first two examples, we will set up the display, setup the rotation, and create a draw object. If you have are using a different display than the ILI9341, go ahead and adjust your initializer as explained in the previous example.

Just like in the first example, we're going to draw a black rectangle to fill up the screen. After that, we're going to set up a couple of constants to help with positioning text. The first is the `padding` and that will be the Y-position of the top-most text and the other is `x` which is the X-Position and represents the left side of the text.

```
# First define some constants to allow easy positioning of text.
padding = -2
x = 0
```

Next, we load a font just like in the second example.

```
font = ImageFont.truetype('/usr/share/fonts/truetype/dejavu/DejaVuSans.ttf', 24)
```

Now we get to the main loop and by using `while True:`, it will loop until Control+C is pressed on the keyboard. The first item inside here, we clear the screen, but notice that instead of giving it a tuple like before, we can just pass `0` and it will draw black.

```
draw.rectangle((0, 0, width, height), outline=0, fill=0)
```

Next, we run a few scripts using the `subprocess` function that get called to the Operating System to get information. The in each command is passed through `awk` in order to be formatted better for the display. By having the OS do the work, we don't have to. These little scripts came from <https://unix.stackexchange.com/questions/119126/command-to-display-memory-usage-disk-usage-and-cpu-load>

```
cmd = "hostname -I | cut -d\ ' ' -f1"
IP = "IP: "+subprocess.check_output(cmd, shell=True).decode("utf-8")
cmd = "top -bn1 | grep load | awk '{printf \"CPU Load: %.2f\\\", $(NF-2)}'"
CPU = subprocess.check_output(cmd, shell=True).decode("utf-8")
cmd = "free -m | awk 'NR==2{printf \"Mem: %s/%s MB %.2f%%\\\", $3,$2,$3*100/$2 }'"
MemUsage = subprocess.check_output(cmd, shell=True).decode("utf-8")
cmd = "df -h | awk '$NF==\"/\">{printf \"Disk: %d/%d GB %s\\\", $3,$2,$5}'"
Disk = subprocess.check_output(cmd, shell=True).decode("utf-8")
cmd = "cat /sys/class/thermal/thermal_zone0/temp | awk '{printf \"CPU Temp: %.1f C\\\", $(NF-0) / 1000}'" # pylint: disable=line-too-long
Temp = subprocess.check_output(cmd, shell=True).decode("utf-8")
```

Now we display the information for the user. Here we use yet another way to pass color information. We can pass it as a color string using the pound symbol, just like we

would with HTML. With each line, we take the height of the line using `getsize()` and move the pointer down by that much.

```
y = padding
draw.text((x, y), IP, font=font, fill="#FFFFFF")
y += font.getsize(IP)[1]
draw.text((x, y), CPU, font=font, fill="#FFFF00")
y += font.getsize(CPU)[1]
draw.text((x, y), MemUsage, font=font, fill="#00FF00")
y += font.getsize(MemUsage)[1]
draw.text((x, y), Disk, font=font, fill="#0000FF")
y += font.getsize(Disk)[1]
draw.text((x, y), Temp, font=font, fill="#FF00FF")
```

Finally, we write all the information out to the display using `disp.image()`. Since we are looping, we tell Python to sleep for `0.1` seconds so that the CPU never gets too busy.

```
disp.image(image)
time.sleep(.1)
```

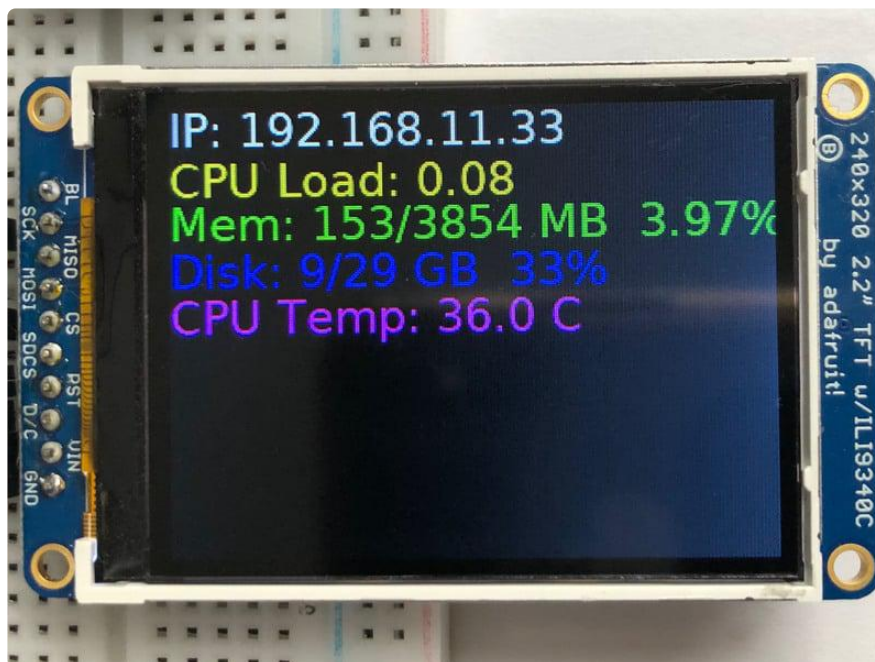

Troubleshooting

Display does not work on initial power but does work after a reset.

The display driver circuit needs a small amount of time to be ready after initial power. If your code tries to write to the display too soon, it may not be ready. It will work on reset since that typically does not cycle power. If you are having this issue, try adding a small amount of delay before trying to write to the display.

In Arduino, use `delay()` to add a few milliseconds before calling `tft.begin()`. Adjust the amount of delay as needed to see how little you can get away with for your specific setup.

Downloads

Datasheets

- [ILI9341 TFT controller chip datasheet \(\)](#) (this is what you want to refer to if porting or if you want to look at the TFT command set)
- [Datasheet for the raw 2.4" screen itself \(\)](#)
- [Adafruit ILI9341 Arduino driver library \(\)](#)
- [EagleCAD PCB files on GitHub \(\)](#)
- [Fritzing object in the Adafruit Fritzing Library \(\)](#)

Schematic

Click to embiggen

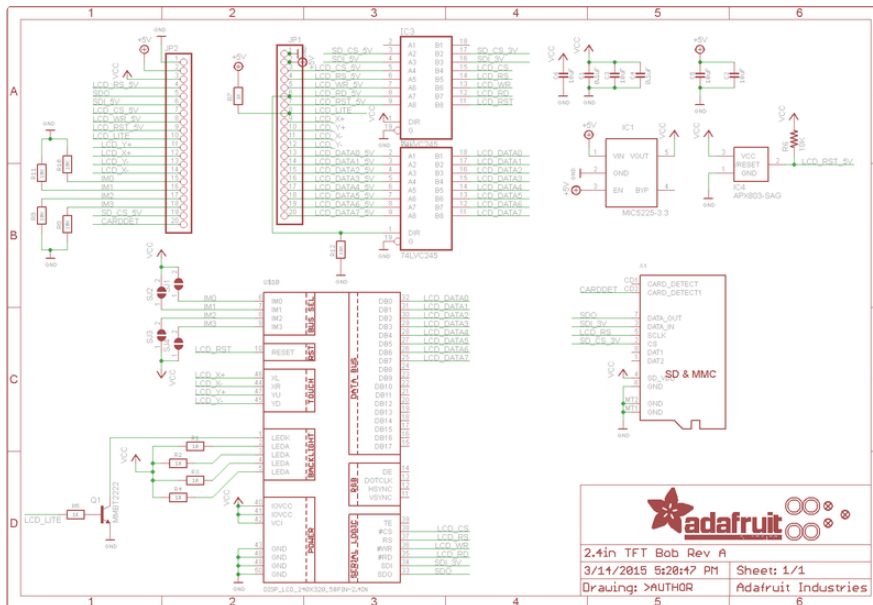

Fabrication Print

Dimensions in Inches

