

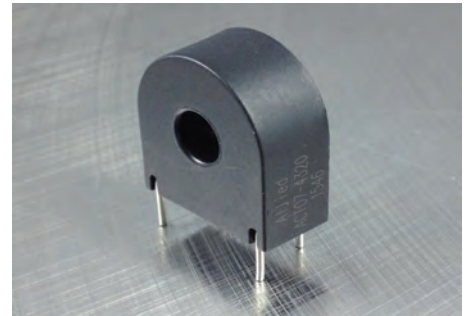

- Mini-Precision Current Transformer
- Good linearity over the entire range
- Ideal for Current Measurement, Monitoring & Protection Applications
- Operating Temp: -40°C to +85°C
- Storage Temp: -45°C to +90°C
- Dielectric Withstanding Voltage (Hi-pot): 4KVrms/1mA/1min
- Impulse Withstand Voltage: 5KV Peak
- Insulation Resistance: DC500V/100MΩ min
- Made with UL Approved Materials



Electrical Specifications	
Rated Primary Current(Amp.) 50/60Hz	10nom (0.01~30Amax.)
Turn Ratio	Np:Ns=1:2000
Current Ratio	10A/5mA
D.C. Resistance at 20°C Max	121Ω
Accuracy @RL≤60Ω	0.1%
Phase error at Rated Current	≤10'
Phase error from 100% to 5% of rated current	≤5'

UL Material Listing	
Enclosure UL File E107536	PBT UL94V-0
Epoxy UL File E222812	9001A/9001B UL94V-0
Wire UL File E201757	UEW/U2/MW75-C 130°

All specifications subject to change without notice.

MECHANICAL

Dimensions (mm):

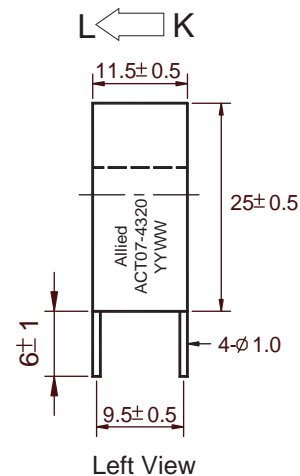
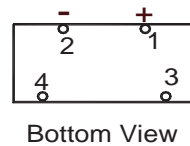
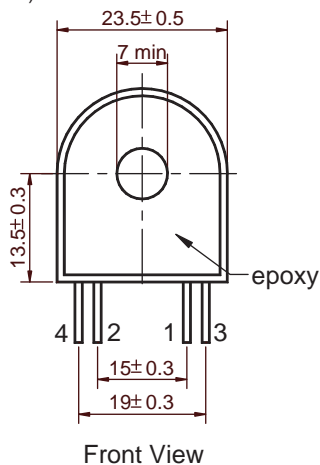

TEST CIRCUIT

