

Standard Nylon Screw Mounts

Features

- Deep Cradle Design Provides Maximum Support for Larger Bundles and Tubing
- Deep Recessed Screw Hole Allows Easy Insertion of Cable Ties to Pass Over Screw Head



SM-01

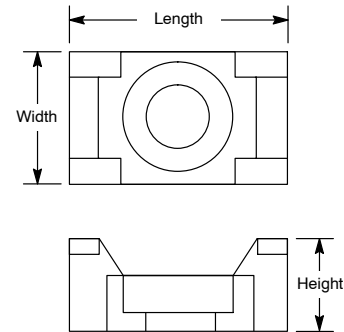

Color Code Chart

0	Black	9	Natural
---	-------	---	---------

Standard Nylon Screw Mounts

NTE Type No.	Length	Height	Width	Slot Height	Slot Width	Screw Size	Qty. per Bag	Diag No.
04-SM1x	.590 / 14.98	.270 / 6.85	.390 / 10.0	.062 / 1.587	.140 / 3.5	#6	100	SM-01
04-SM2x	.870 / 22.09	.390 / 9.8	.630 / 16.0	.125 / 3.175	.250 / 6.3	1/4"	100	SM-01

Note 1. Replace "x" in device number with corresponding color code from the "Color Code Chart".

Note 2. Dimensions are listed as "inch / millimeter".

Low Profile Nylon Natural Screw Mounts

Features

- Reduces Snags Allowing Bundles Closer Proximity to Mounting Material
- Confined Spaces and Control panels or Other Areas where Space is Limited
- Achieve Extreme Low Height when Combined with Cobra Low Profile Cable Tie



SM-02

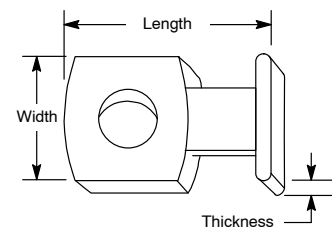

Low Profile Nylon Screw Mounts

NTE Type No.	Length	Height	Width	Slot Height	Slot Width	Screw Size	Qty. per Bag	Diag No.
04-LPM19	.750 / 19.05	.120 / 3.04	.500 / 12.70	.062 / 1.587	.180 / 4.57	#8	100	SM-02

Note 2. Dimensions are listed as "inch / millimeter".