

Product: [TAP-PA 4](#)



Mini Power Reducing Tee Connector: 1 3/8" male to 1 3/8" female and 7/8" female, 4-pin(3+PE), black body, 600 V, 15 A

Product Description

Mini Power Reducing Tee Connector: 1 3/8" male to 1 3/8" female and 7/8" female, 4-pin(3+PE), black body, 600 V, 15 A

Technical Drawing

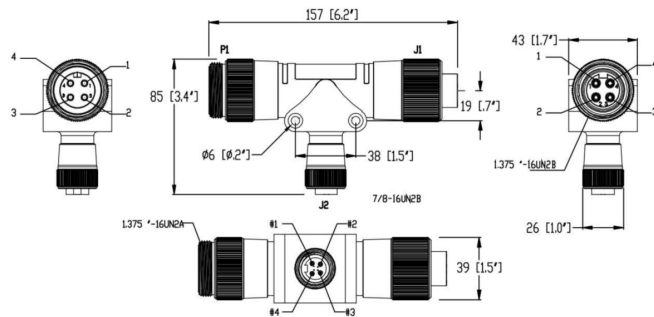

Technical Specifications

Product Description

Product Family:	Power Connector
Brand:	Lumberg Automation
Connector Type:	Reducing Tee
Shielding:	Unshielded
Rated Voltage (UL):	600 V
Rated Current (UL)*:	15 A

Technical Data Side 1

Product Sub Family:	Mini Power 1-3/8"
Type of Contact / Gender:	male
Connector Design:	straight
Attachment Type:	Coupling Nut
Number of Pins:	4(3+PE)
Mating Cycles:	≤ 100
Ambient Temperature (Operation)*:	-40°C to +90°C
Protection Degree / IP Rating**:	IP65, IP67
Contact Base Material:	Cu Alloy
Contact Plating:	Au
Contact Bearer Material:	PVC
Contact Bearer Color:	black
Molded Body Material:	PVC
Molded Body Color:	Black

Technical Data Side 2

Product Sub Family, Side 2:	Mini Power 1-3/8"
Type of Contact / Gender, Side 2:	female
Connector Design, Side 2:	straight
Attachment Type, Side 2:	Coupling Nut
Number of Pins, Side 2:	4(3+PE)
Mating Cycles, Side 2:	≤ 100
Ambient Temperature (Operation), Side 2*:	-40°C to +90°C
Protection Degree / IP Rating, Side 2**:	IP65, IP67
Contact Base Material, Side 2:	Cu Alloy
Contact Plating, Side 2:	Au
Contact Bearer Material, Side 2:	PVC
Contact Bearer Color, Side 2:	black
Molded Body Material, Side 2:	PVC
Molded Body Color, Side 2:	Black

Technical Data Side 3

Product Sub Family, Side 3:	Mini Power 7/8"
Type of Contact / Gender, Side 3:	female
Connector Design, Side 3:	straight
Attachment Type, Side 3:	Coupling Nut
Number of Pins, Side 3:	4(3+PE)
Mating Cycles, Side 3:	≤ 100
Ambient Temperature (Operation), Side 3*:	-40°C to +90°C
Protection Degree / IP Rating, Side 3**:	IP65, IP67
Contact Base Material, Side 3:	Cu Alloy
Contact Plating, Side 3:	Au
Contact Bearer Material, Side 3:	PVC
Contact Bearer Color, Side 3:	black
Molded Body Material, Side 3:	PVC
Molded Body Color, Side 3:	Black

Approvals

UL-File:	UL: E482233
UL:	UL 2237
CSA:	C-UL LISTED: E482233

Safety & Environmental Compliance

RoHS Compliant:	yes
-----------------	-----

Notes

Protection Degree / IP Rating Note:	** only if mounted and locked in combination with Hirschmann / Lumberg Automation connector.
-------------------------------------	--

Variants

Item #	Item Description
511000002	TAP-PA 4

© 2023 Belden, Inc

All Rights Reserved.

Although Belden makes every reasonable effort to ensure their accuracy at the time of this publication, information and specifications described here in are subject to error or omission and to change without notice, and the listing of such information and specifications does not ensure product availability.

Belden provides the information and specifications herein on an "ASIS" basis, with no representations or warranties, whether express, statutory or implied. In no event will Belden be liable for any damages (including consequential, indirect, incidental, special, punitive, or exemplary damages) whatsoever, even if Belden has been advised of the possibility of such damages, whether in an action under contract, negligence or any other theory, arising out of or in connection with the use, or inability to use, the information or specifications described herein.

All sales of Belden products are subject to Belden's standard terms and conditions of sale.

Belden believes this product to be in compliance with all applicable environmental programs as listed in the data sheet. The information provided is correct to the best of Belden's knowledge, information and belief at the date of its publication. This information is designed only as a general guide for the safe handling, storage, and any other operation of the product itself or the one that it becomes a part of. The Product Disclosure is not to be considered a warranty or quality specification. Regulatory information is for guidance purposes only. Product users are responsible for determining the applicability of legislation and regulations based on their individual usage of the product.