

ACEPACK 2 power module, fourpack topology, 1200 V, 13 mΩ typ. SiC Power MOSFET gen.2 with NTC

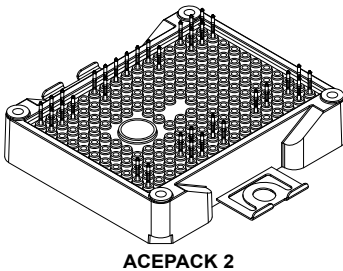

ACEPACK 2

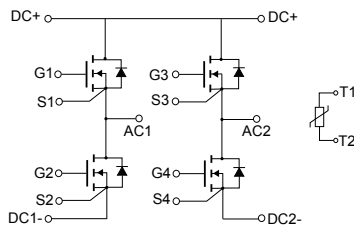

Features

- Fourpack topology
- ACEPACK 2 power module
 - 13 mΩ of typical $R_{DS(on)}$ each switch
 - Insulation voltage UL certified of 2.5 kVrms
 - Integrated NTC temperature sensor
 - DBC Cu-Al₂O₃-Cu based
 - Press-fit contact pins

Applications

- DC/DC converter

Description

This ACEPACK 2 power module in fourpack topology integrates advanced silicon carbide Power MOSFET technology from STMicroelectronics. The module leverages the innovative properties of the wide-bandgap SiC material and a high-thermal-performance substrate. The result is exceptionally low on-resistance per unit area and excellent switching performance that is virtually independent of temperature. An NTC sensor completes the design.



Product status link

[A2F12M12W2-F1](#)

Product summary

Order code	A2F12M12W2-F1
Marking	A2F12M12W2-F1
Package	ACEPACK 2
Leads type	Press-fit
Packing	Tray

1 Electrical rating

$T_J = 25\text{ °C}$ unless otherwise specified.

Table 1. Absolute maximum ratings

Symbol	Parameter	Value	Unit
V_{DS}	Drain-source voltage	1200	V
V_{GS}	Gate-source voltage	-10 to 22	V
	Gate-source voltage, recommended operating values	-5 to 18	
I_D	Drain current (continuous) at $T_H = 25\text{ °C}$	75	A
$I_{DM}^{(1)}$	Repetitive peak drain current	150	A
T_J	Maximum junction temperature	175	°C
	Operating junction temperature range under switching conditions	-40 to 150	

1. Pulse width limited by maximum junction temperature.

Table 2. Thermal data

Symbol	Parameter	Value	Unit
R_{thJH}	Thermal resistance, junction-to-heat sink ($TIM = 120\text{ }\mu\text{m}$, $\lambda = 3\text{ W}\cdot\text{m}^{-1}\cdot\text{°C}^{-1}$)	0.72	°C/W

2 Electrical characteristics

Table 3. On/off-state

Symbol	Parameter	Test conditions	Min.	Typ.	Max.	Unit
$V_{(BR)DSS}$	Drain-source breakdown voltage	$V_{GS} = 0\text{ V}$, $I_D = 1\text{ mA}$	1200			V
$R_{DS(on)}$	Static drain-source on-resistance	$V_{GS} = 18\text{ V}$, $I_D = 75\text{ A}$		13	17	mΩ
		$V_{GS} = 18\text{ V}$, $I_D = 75\text{ A}$, $T_J = 150\text{ °C}$		20		
$V_{GS(th)}$	Gate threshold voltage	$I_D = 10\text{ mA}$, $V_{DS} = V_{GS}$	1.9	3.0	4.9	V
I_{DSS}	Zero gate voltage drain current	$V_{DS} = 1200\text{ V}$, $V_{GS} = 0\text{ V}$			200	μA
I_{GSS}	Gate-body leakage current	$V_{DS} = 0$, $V_{GS} = -10\text{ to }22\text{ V}$			±1	μA
C_{iss}	Input capacitance	$f = 1\text{ MHz}$, $V_{DS} = 800\text{ V}$, $V_{GS} = 0\text{ V}$		7000		pF
C_{oss}	Output capacitance			352		pF
C_{rss}	Reverse transfer capacitance			56		pF
R_G	Intrinsic gate resistance	$f = 1\text{ MHz}$, $I_D = 0\text{ A}$		1		Ω
Q_g	Total gate charge	$V_{DD} = 800\text{ V}$, $V_{GS} = -5\text{ to }18\text{ V}$, $I_D = 100\text{ A}$		294		nC
Q_{gs}	Gate-source charge			65		nC
Q_{gd}	Gate-drain charge			109		nC

Table 4. Switching energy

Symbol	Parameter	Test conditions	Min.	Typ.	Max.	Unit
E_{on}	Turn-on switching energy	$V_{DD} = 800\text{ V}$, $I_D = 75\text{ A}$, $V_{GS} = -5\text{ to }18\text{ V}$, $R_{G(on)} = 5.6\text{ Ω}$, $R_{G(off)} = 1\text{ Ω}$	-	1.48	-	mJ
E_{off}	Turn-off switching energy			-	0.35	
E_{on}	Turn-on switching energy	$V_{DD} = 800\text{ V}$, $I_D = 75\text{ A}$, $V_{GS} = -5\text{ to }18\text{ V}$, $R_{G(on)} = 5.6\text{ Ω}$, $R_{G(off)} = 1\text{ Ω}$, $T_J = 150\text{ °C}$	-	1.51	-	mJ
E_{off}	Turn-off switching energy			-	0.32	

Table 5. Source-drain diode

Symbol	Parameter	Test conditions	Min.	Typ.	Max.	Unit
V_{SD}	Forward on voltage drop	$V_{GS} = 0\text{ V}$, $I_{SD} = 75\text{ A}$	-	2.9	-	V
t_{rr}	Reverse recovery time	$I_{SD} = 75\text{ A}$, $V_{DD} = 800\text{ V}$, $V_{GS} = -5\text{ V}$	-	42	-	ns
Q_{rr}	Reverse recovery charge		-	896	-	nC
I_{RRM}	Reverse recovery current		-	60	-	A
E_{rr}	Reverse recovery energy		-	336	-	μJ

2.1 Electrical characteristics (curves)

Figure 1. Typical output characteristics ($T_J = -40^\circ\text{C}$)

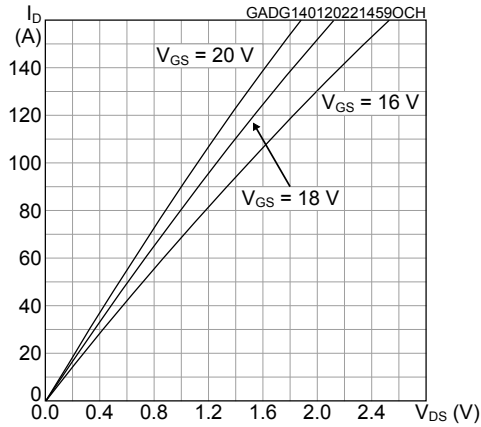

Figure 2. Typical output characteristics ($T_J = 25^\circ\text{C}$)

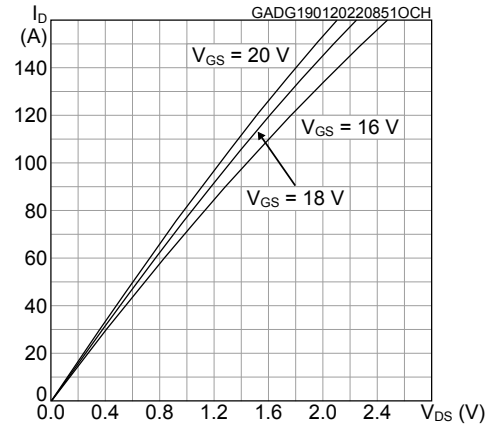

Figure 3. Typical output characteristics ($T_J = 150^\circ\text{C}$)

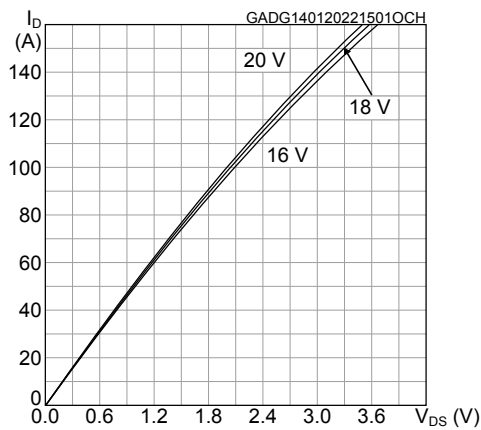

Figure 4. Typical transfer characteristics

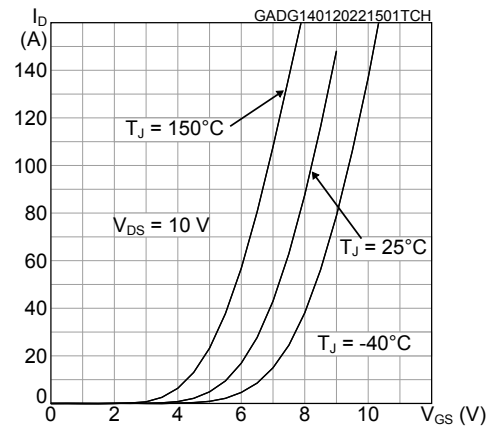

Figure 5. Typical diode forward characteristics (terminal)

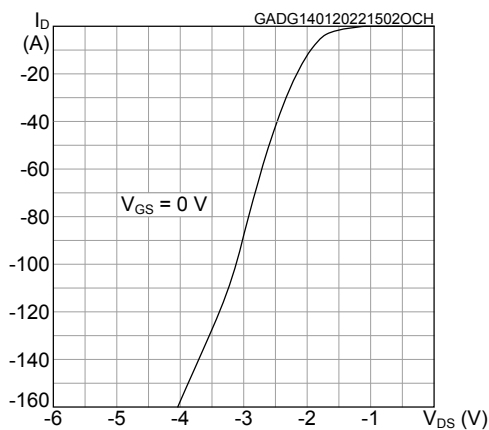

Figure 6. Typical gate charge characteristics

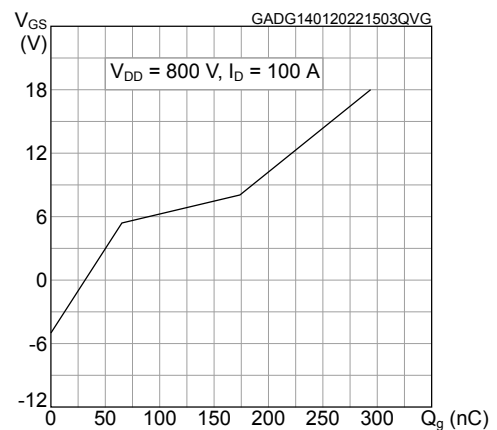

Figure 7. Typical switching energy vs drain current
($T_J = 25\text{ }^\circ\text{C}$)

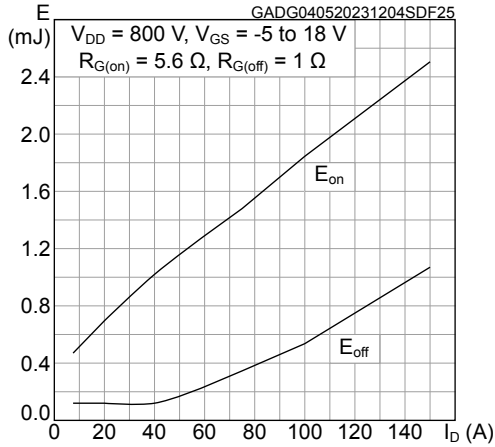

Figure 8. Typical switching energy vs drain current
($T_J = 150\text{ }^\circ\text{C}$)

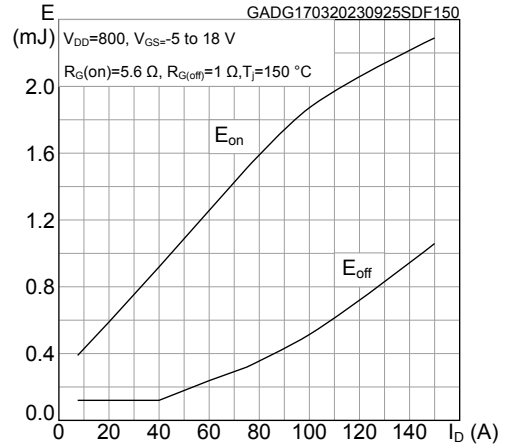

Figure 9. Typical switching energy vs gate resistance
($T_J = 25\text{ }^\circ\text{C}$)

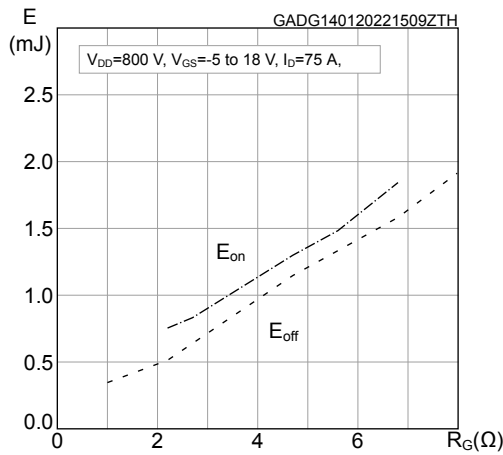

Figure 10. Typical switching energy vs gate resistance
($T_J = 150\text{ }^\circ\text{C}$)

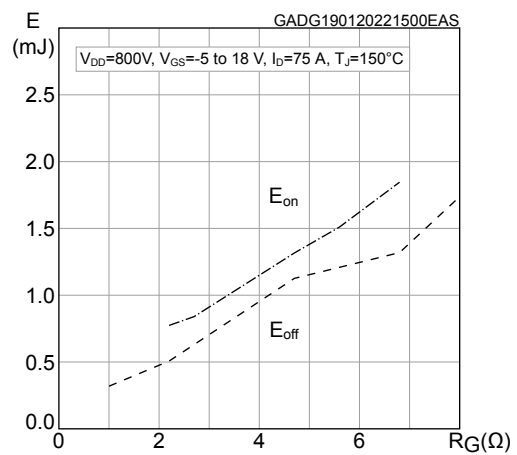

Figure 11. Typical switching energy vs temperature

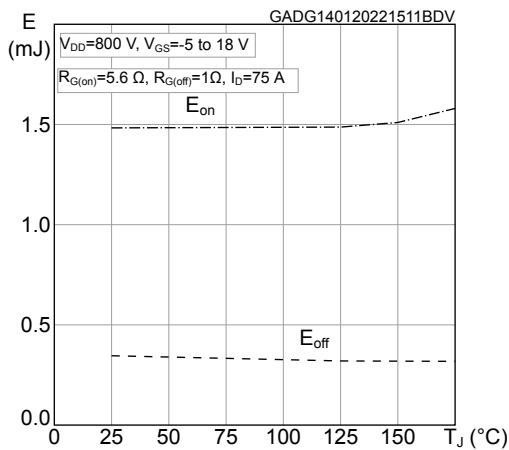

Figure 12. Typical switching energy vs V_{GS} ($T_J = 25\text{ }^\circ\text{C}$)

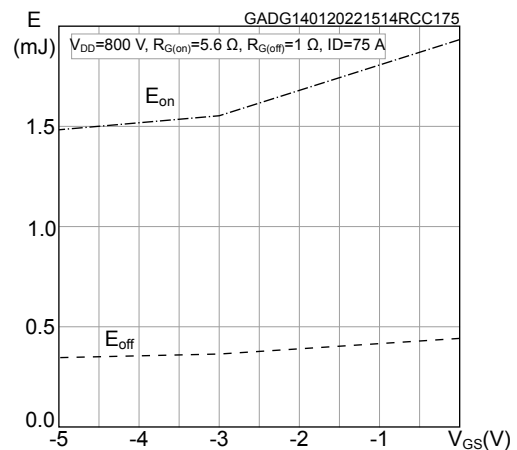

Figure 13. Typical switching energy vs V_{GS} ($T_J = 150^\circ\text{C}$)

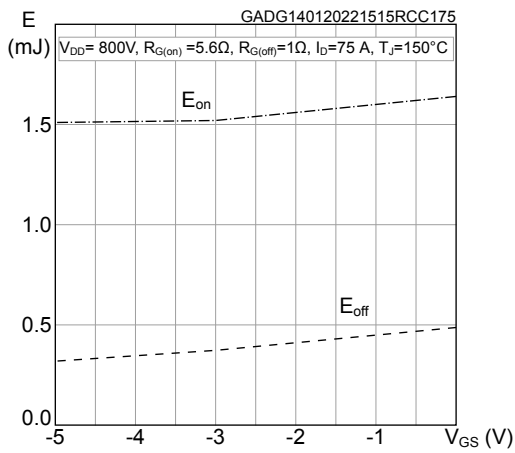
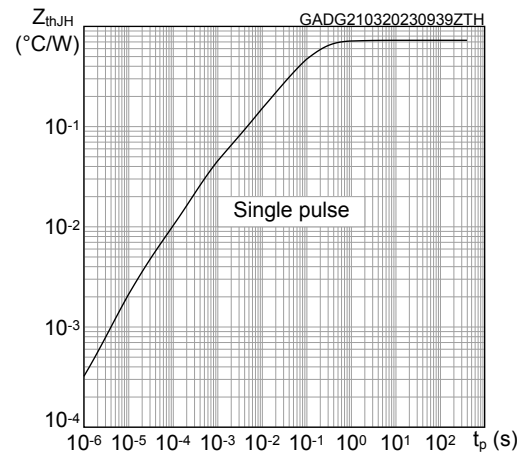

Figure 14. Maximum transient thermal impedance



3 NTC

Table 6. Absolute maximum ratings for NTC temperature sensor, considered as stand-alone

Symbol	Parameter	Test condition	Min.	Typ.	Max.	Unit
R ₂₅	Resistance rating	T = 25 °C		5		kΩ
R ₁₀₀	Resistance rating	T = 100 °C		493		Ω
ΔR ₁₀₀ /R	Resistance tolerance		-5		5	%
B	B value	T = 25 to 50 °C		3375		K
		T = 25 to 85 °C		3411		
T	Operating temperature range		-40		150	°C

Figure 15. NTC typical resistance vs temperature

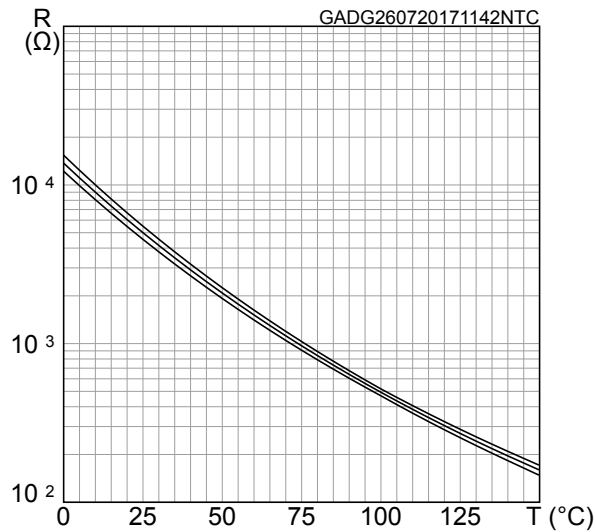
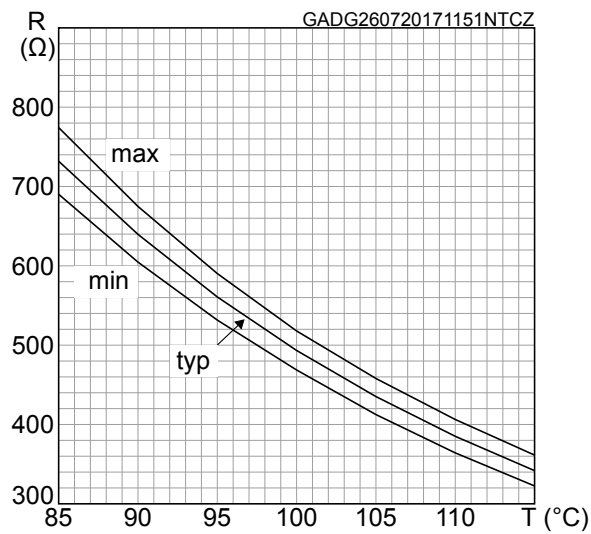

Figure 16. NTC resistance vs temperature, zoom



4 Package

Table 7. ACEPACK 2 package

Symbol	Parameter	Min.	Typ.	Max.	Unit
V_{ISO}	Isolation withstand voltage applied between each pin and heat sink plate (AC voltage, $t = 60$ s)	2.5			kVrms
M_d	Mounting torque (M4 screw)	2.0		2.3	N•m
CTI	Comparative tracking index	200			V
L_s	Stray inductance module loop		12		nH
T_{stg}	Storage temperature range	-40		125	°C

5 Electrical topology and pin description

Figure 17. Electrical topology and pin description

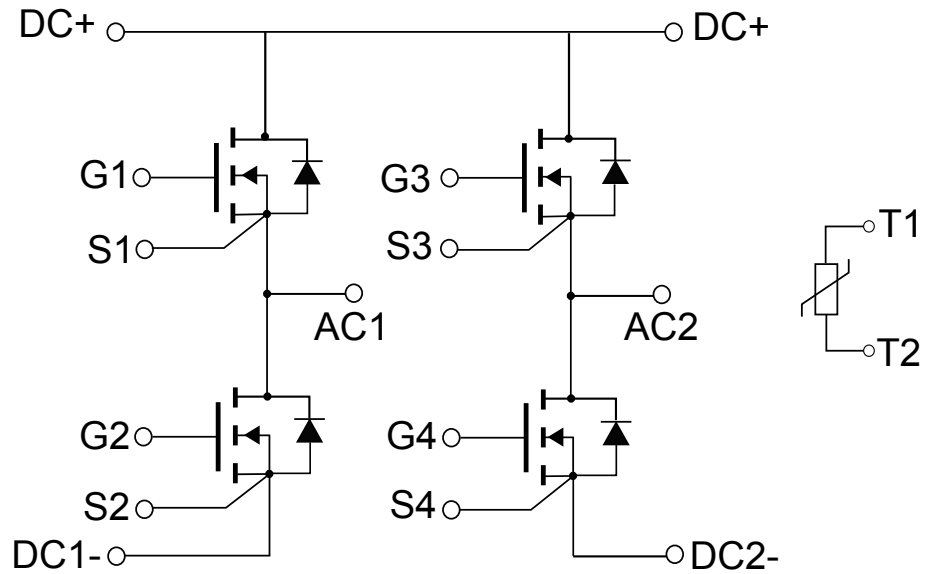
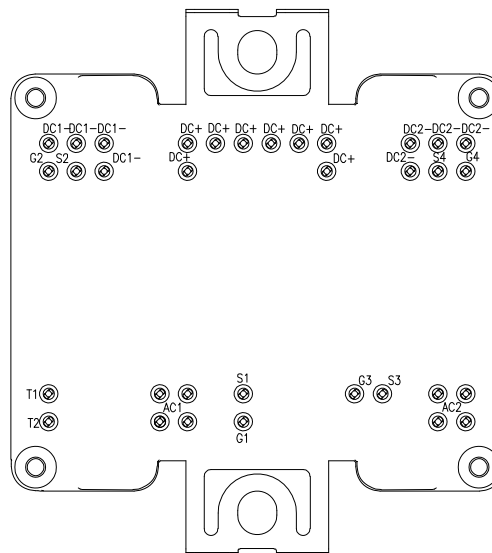

Figure 18. Package top view with pinout



GADG051020211046SA

6 Package information

In order to meet environmental requirements, ST offers these devices in different grades of **ECOPACK** packages, depending on their level of environmental compliance. ECOPACK specifications, grade definitions and product status are available at: www.st.com. ECOPACK is an ST trademark.

6.1 ACEPACK 2 fourpack press-fit package information

Figure 19. ACEPACK 2 fourpack press-fit package outline (dimensions are in mm)

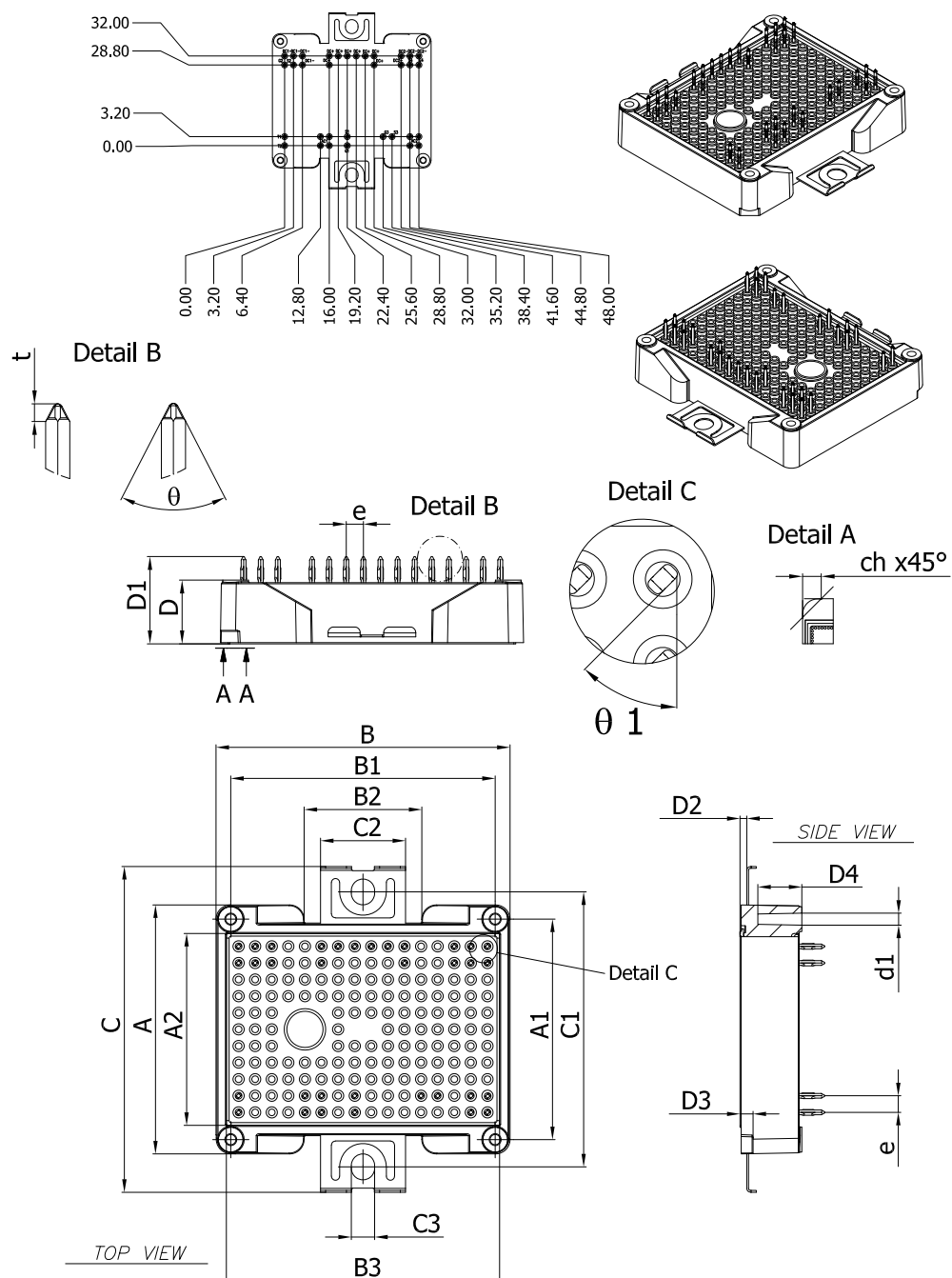

8569722_13_fourpack_press_fit

Table 8. ACEPACK 2 fourpack press-fit mechanical data

Dim.	mm		
	Min.	Typ.	Max.
A	47.70	48.00	48.30
A1	42.30	42.50	42.70
A2	37.00 REF		
B	56.40	56.70	57.00
B1	50.85	51.00	51.15
B2	22.40	22.70	23.00
B3	52.70 REF		
C	62.30	62.80	63.30
C1	52.90	53.00	53.10
C2	16.20	16.40	16.60
C3	4.40	4.50	4.60
D	11.65	12.00	12.35
D1	15.90	16.40	16.90
D2	1.10	1.30	1.50
D3	2.30	2.50	2.70
D4			8.50
t	0.30	0.40	0.50
θ	52°	60°	68°
θ1		45°	
e	3.20 BSC		
d1	2.30 REF		
ch	3.50 REF		

Revision history

Table 9. Document revision history

Date	Revision	Changes
18-Oct-2021	1	First release.
01-Feb-2022	2	Updated the description in cover page, <i>Table 2. Thermal data</i> , <i>Table 3. Electrical characteristics</i> and <i>Table 5. Source drain diode</i> . Updated <i>Table 7. ACEPACK 2 package</i> . Added <i>Section 4 Electrical characteristics (curves)</i> . Minor text changes.
11-Feb-2022	3	Updated title, <i>features</i> and <i>description</i> in cover page. Updated <i>Section 1 Electrical rating</i> , <i>Section 3 NTC</i> , <i>Section 4 Package</i> and <i>Section 5 Electrical topology and pin description</i> . Added <i>Section 2 Electrical characteristics</i> . Minor text changes.
15-May-2023	4	Updated <i>Table 1. Absolute maximum ratings</i> . Updated <i>Table 2. Thermal data</i> . Updated <i>Table 3. On/off-state</i> . Updated <i>Table 4. Switching energy</i> . Updated <i>Figure 7. Typical switching energy vs drain current (T_J = 25 °C)</i> , <i>Figure 8. Typical switching energy vs drain current (T_J = 150 °C)</i> , <i>Figure 9. Typical switching energy vs gate resistance (T_J = 25 °C)</i> , <i>Figure 10. Typical switching energy vs gate resistance (T_J = 150 °C)</i> , <i>Figure 11. Typical switching energy vs temperature</i> , <i>Figure 12. Typical switching energy vs V_{GS} (T_J = 25 °C)</i> , <i>Figure 13. Typical switching energy vs V_{GS} (T_J = 150 °C)</i> and <i>Figure 14. Maximum transient thermal impedance</i> . Updated <i>Figure 19. ACEPACK 2 fourpack press-fit package outline (dimensions are in mm)</i> . Minor text changes.

Contents

1	Electrical rating	2
2	Electrical characteristics	3
2.1	Electrical characteristics (curves)	4
3	NTC	7
4	Package	8
5	Electrical topology and pin description	9
6	Package information	10
6.1	ACEPACK 2 fourpack press-fit package information	10
	Revision history	13

IMPORTANT NOTICE – READ CAREFULLY

STMicroelectronics NV and its subsidiaries (“ST”) reserve the right to make changes, corrections, enhancements, modifications, and improvements to ST products and/or to this document at any time without notice. Purchasers should obtain the latest relevant information on ST products before placing orders. ST products are sold pursuant to ST’s terms and conditions of sale in place at the time of order acknowledgment.

Purchasers are solely responsible for the choice, selection, and use of ST products and ST assumes no liability for application assistance or the design of purchasers’ products.

No license, express or implied, to any intellectual property right is granted by ST herein.

Resale of ST products with provisions different from the information set forth herein shall void any warranty granted by ST for such product.

ST and the ST logo are trademarks of ST. For additional information about ST trademarks, refer to www.st.com/trademarks. All other product or service names are the property of their respective owners.

Information in this document supersedes and replaces information previously supplied in any prior versions of this document.

© 2023 STMicroelectronics – All rights reserved