

## Features

- $BV_{CEO} > -20V$
- $I_C = -5A$  Continuous Current
- Low Saturation Voltage  $V_{CE(sat)} < -0.5V @ -50mA$
- $P_D = 2.4W$  Power Dissipation
- $R_{sat} = 39m\Omega$  for a Low Equivalent On-Resistance
- Complementary part number ZXTN25020DZ
- **Totally Lead-Free & Fully RoHS Compliant (Notes 1 & 2)**
- **Halogen- and Antimony-Free. "Green" Device (Note 3)**
- **For automotive applications requiring specific change control (i.e. parts qualified to AEC-Q100/101/200, PPAP capable, and manufactured in IATF 16949 certified facilities), please [contact us](mailto:contact@diodes.com) or your local Diodes representative. <https://www.diodes.com/quality/product-definitions/>**

## Mechanical Data

- Case: SOT89
- Case Material: Molded Plastic. "Green" Molding Compound. UL Flammability Rating 94V-0
- Moisture Sensitivity: Level 1 per J-STD-020
- Terminals: Finish - Matte Tin Plated Leads, Solderable per MIL-STD-202, Method 208 ③
- Weight: 0.05 grams (Approximate)

## Application

- DC-DC converters
- Load switch
- Motor drive
- Disconnect switch
- MOSFET and IGBT gate drive

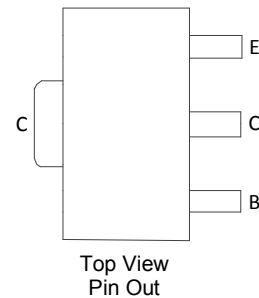
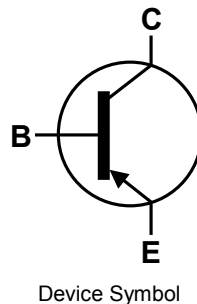

## Ordering Information (Note 4)

Part Number	Compliance	Marking	Reel Size (inches)	Tape Width (mm)	Quantity Per Reel
ZXTP25020DZTA	Standard	1L5	7	12	1,000

- Notes:
1. No purposely added lead. Fully EU Directive 2002/95/EC (RoHS), 2011/65/EU (RoHS 2) & 2015/863/EU (RoHS 3) compliant.
  2. See <https://www.diodes.com/quality/lead-free/> for more information about Diodes Incorporated's definitions of Halogen- and Antimony-free, "Green" and Lead-free.
  3. Halogen- and Antimony-free "Green" products are defined as those which contain <900ppm bromine, <900ppm chlorine (<1500ppm total Br + Cl) and <1000ppm antimony compounds.
  4. For packaging details, go to our website at <https://www.diodes.com/design/support/packaging/diodes-packaging/>.

## Marking Information

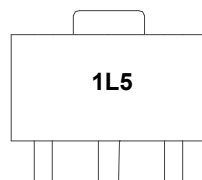

1L5 = Product Type Marking Code

**Absolute Maximum Ratings** (@  $T_A = +25^\circ\text{C}$ , unless otherwise specified.)

Characteristic	Symbol	Value	Unit
Collector-Base Voltage	$V_{CBO}$	-25	V
Collector-Emitter Voltage	$V_{CEO}$	-20	V
Emitter-Collector voltage (reverse blocking)	$V_{ECO}$	-4	V
Emitter-Base Voltage	$V_{EBO}$	-7	V
Continuous Collector Current	$I_C$	-5	A
Base current	$I_B$	-1	A
Peak Pulse Current (Single pulse)	$I_{CM}$	-10	A

**Thermal Characteristics** (@  $T_A = +25^\circ\text{C}$ , unless otherwise specified.)

Characteristic	Symbol	Value	Unit
Power Dissipation (Note 5) Linear Derating Factor	$P_D$	1.1 8.8	W mW/ $^\circ\text{C}$
Power Dissipation (Note 6) Linear Derating Factor	$P_D$	1.8 14.4	W mW/ $^\circ\text{C}$
Power Dissipation (Note 7) Linear Derating Factor	$P_D$	2.4 19.2	W mW/ $^\circ\text{C}$
Power Dissipation (Note 8) Linear Derating Factor	$P_D$	4.46 35.7	W mW/ $^\circ\text{C}$
Power Dissipation (Note 9) Linear Derating Factor	$P_D$	15.7 126	W mW/ $^\circ\text{C}$
Thermal Resistance, Junction to Ambient (Note 5)	$R_{\theta JA}$	117	$^\circ\text{C}/\text{W}$
Thermal Resistance, Junction to Ambient (Note 6)	$R_{\theta JA}$	68	$^\circ\text{C}/\text{W}$
Thermal Resistance, Junction to Ambient (Note 7)	$R_{\theta JA}$	51	$^\circ\text{C}/\text{W}$
Thermal Resistance, Junction to Ambient (Note 8)	$R_{\theta JA}$	28	$^\circ\text{C}/\text{W}$
Thermal Resistance, Junction to Case (Note 9)	$R_{\theta JC}$	7.95	$^\circ\text{C}/\text{W}$
Operating and Storage Temperature Range	$T_J, T_{STG}$	-55 to +150	$^\circ\text{C}$

- Notes:
5. For a device surface mounted on 15mm x 15mm x 0.6mm FR4 PCB with high coverage of single sided 1oz copper, in still air conditions; device measured when operating in steady state condition.
  6. Same as note (5), except the device is mounted on 25mm x 25mm x 0.6mm single sided 1oz weight copper.
  7. Same as note (5), except the device is mounted on 50mm x 50mm x 0.6mm single sided 1oz weight copper.
  8. Same as note (5), except the device is measured at  $t < 5$  seconds
  9. Junction to case (collector tab). Typical.

**Thermal Characteristics and Derating Information**

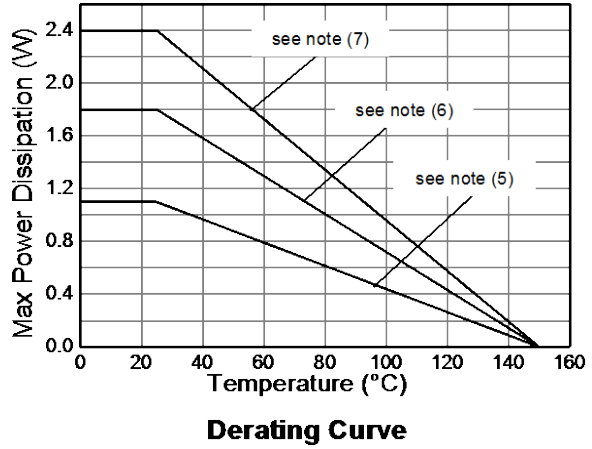
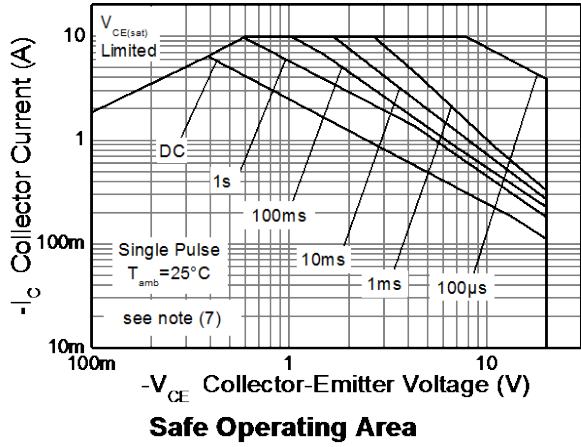

**Thermal Characteristics and Derating Information**

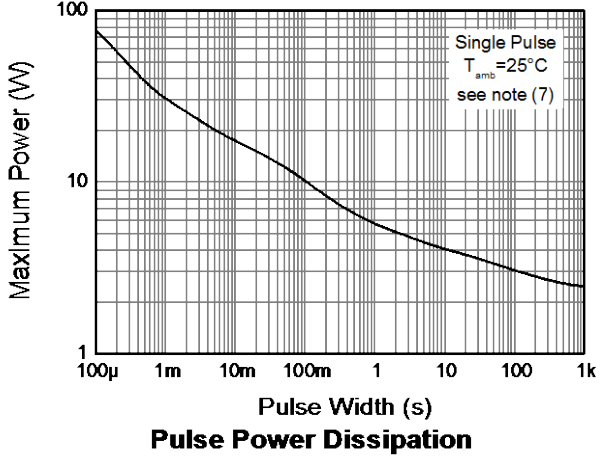
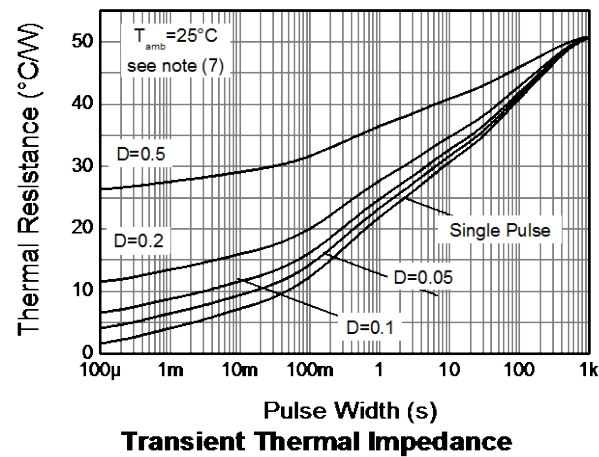
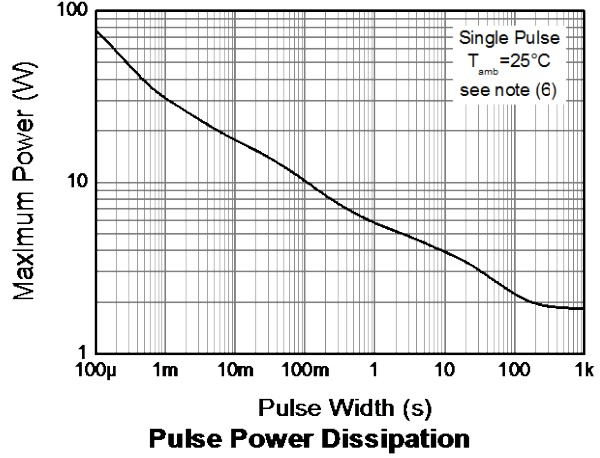
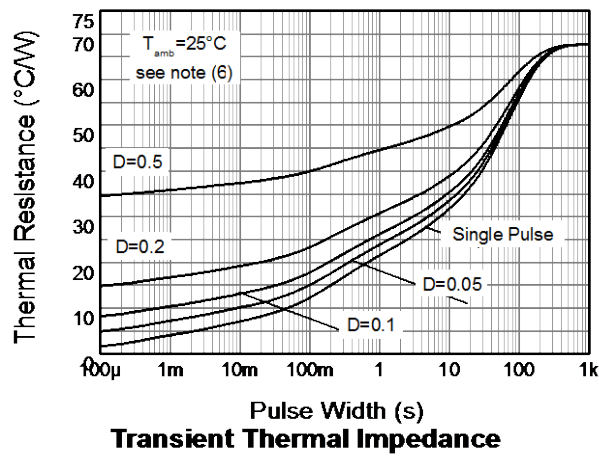
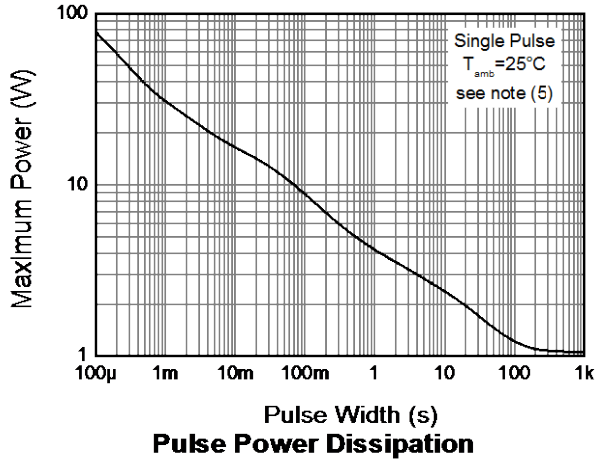
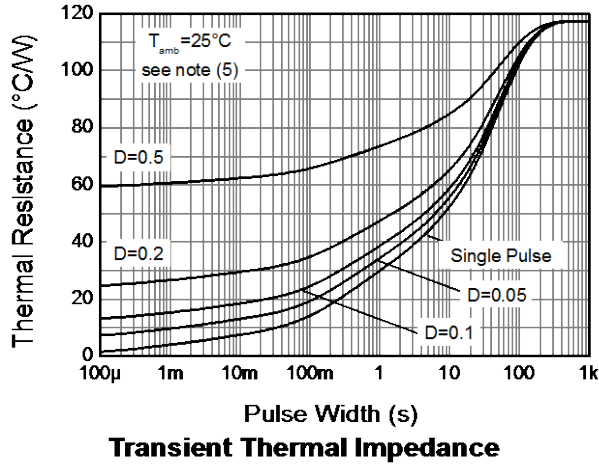

**Electrical Characteristics** (@  $T_A = +25^\circ\text{C}$ , unless otherwise specified.)

Characteristic	Symbol	Min	Typ	Max	Unit	Test Condition	
Collector-Base Breakdown Voltage	$BV_{CBO}$	-25	-55	—	V	$I_C = -100\mu\text{A}$	
Collector- Emitter Breakdown Voltage (Note 10)	$BV_{CEO}$	-20	-45	—	V	$I_C = -10\text{mA}$	
Emitter-collector breakdown voltage (reverse blocking)	$BV_{ECX}$	-4	-8.5	—	V	$I_E = -100\mu\text{A}$ , $R_{BC} \leq 1\text{k}\Omega$ or $0.25\text{V} > V_{BE} > -0.25\text{V}$	
Emitter-Collector Breakdown Voltage	$BV_{ECO}$	-4	-8.5	—	V	$I_E = -100\mu\text{A}$	
Emitter-Base Breakdown Voltage	$BV_{EBO}$	-7	-8.3	—	V	$I_E = -100\mu\text{A}$	
Collector Cut-Off Current	$I_{CBO}$	—	-1	-50	nA	$V_{CB} = -25\text{V}$	
Emitter Cut-Off Current	$I_{EBO}$	—	-1	-50	nA	$V_{EB} = -5.6\text{V}$	
Collector-Emitter Saturation Voltage (Note 10)	$V_{CE(sat)}$	—	-50 -150 -185 -195	-65 -215 -245 -265	mV	$I_C = -1\text{A}$ , $I_B = -100\text{mA}$ $I_C = -1\text{A}$ , $I_B = -10\text{mA}$ $I_C = -2\text{A}$ , $I_B = -40\text{mA}$ $I_C = -5\text{A}$ , $I_B = -500\text{mA}$	
Base-Emitter Saturation Voltage (Note 10)	$V_{BE(sat)}$	—	-1010	-1100	mV	$I_C = -5\text{A}$ , $I_B = -500\text{mA}$	
Base-Emitter Turn-On Voltage (Note 10)	$V_{BE(on)}$	—	-870	-1000	mV	$I_C = -5\text{A}$ , $V_{CE} = -2\text{V}$	
DC current gain (Note 10)	$h_{FE}$	300 200 45 —	450 310 85 20	900 — — —	—	$I_C = -10\text{mA}$ , $V_{CE} = -2\text{V}$ $I_C = -1\text{A}$ , $V_{CE} = -2\text{V}$ $I_C = -5\text{A}$ , $V_{CE} = -2\text{V}$ $I_C = -10\text{A}$ , $V_{CE} = -2\text{V}$	
Transitional frequency	$f_T$	—	290	—	MHz	$I_C = -50\text{mA}$ , $V_{CE} = -10\text{V}$ , $f = 100\text{MHz}$	
Input Capacitance	$C_{ibo}$	—	21	—	pF	$V_{EB} = -0.5\text{V}$ , $f = 1\text{MHz}$	
Output Capacitance	$C_{obo}$	—	157	—	pF	$V_{CB} = -10\text{V}$ , $f = 1\text{MHz}$	
Delay time	$t_d$	—	14.2	—	ns	$I_C = -1\text{A}$ , $V_{CC} = -10\text{V}$ , $I_{B1} = -I_{B2} = -50\text{mA}$	
Rise time	$t_r$						16.3
Storage time	$t_s$						186
Fall time	$t_f$						32.7

 Note: 10. Measured under pulsed conditions. Pulse width  $\leq 300\mu\text{s}$ . Duty cycle  $\leq 2\%$ .

**Typical Electrical Characteristics** (@  $T_A = +25^\circ\text{C}$ , unless otherwise specified.)

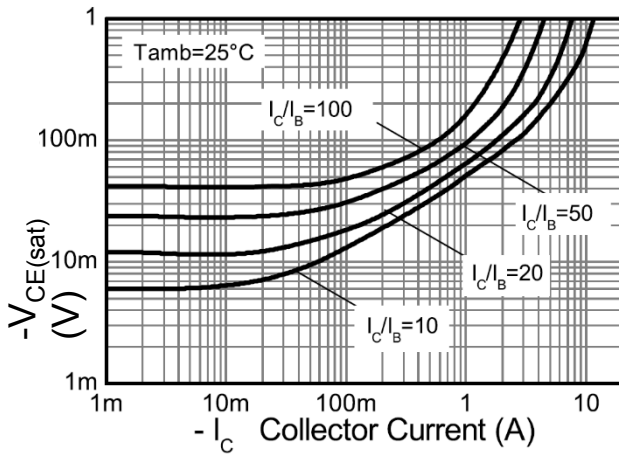

$V_{CE(sat)} \text{ v } I_C$

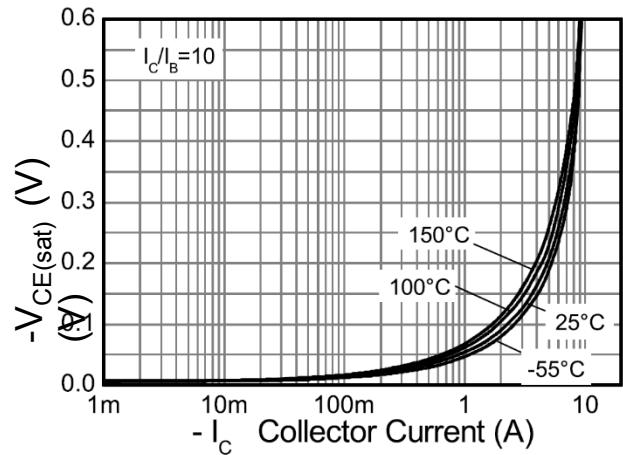

$V_{CE(sat)} \text{ v } I_C$

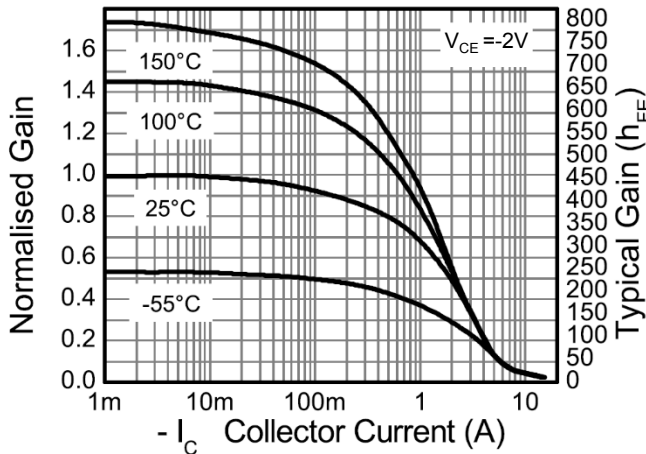

$h_{FE} \text{ v } I_C$

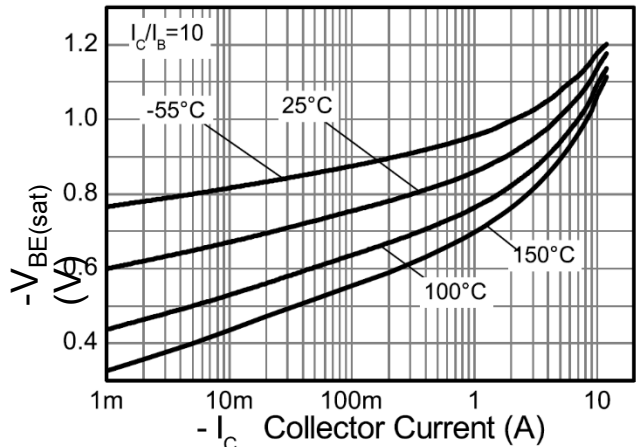

$V_{BE(sat)} \text{ v } I_C$

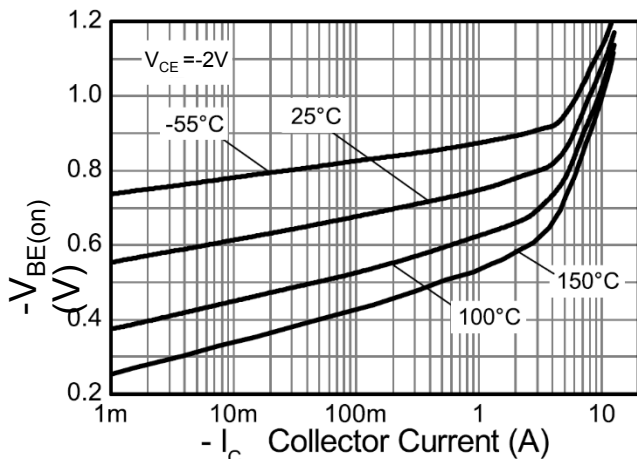

$V_{BE(on)} \text{ v } I_C$

**Package Outline Dimensions**

Please see <http://www.diodes.com/package-outlines.html> for the latest version.

**SOT89**

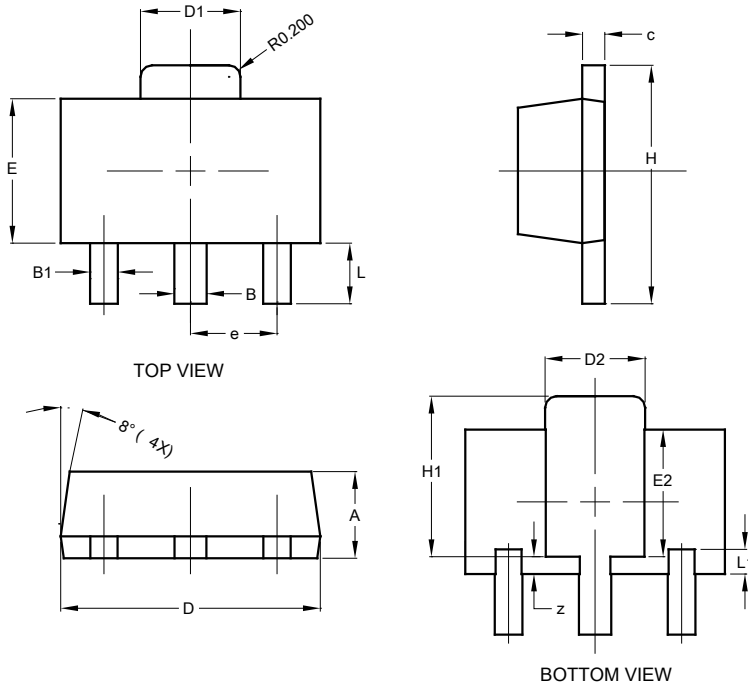

SOT89			
Dim	Min	Max	Typ
A	1.40	1.60	1.50
B	0.50	0.62	0.56
B1	0.42	0.54	0.48
c	0.35	0.43	0.38
D	4.40	4.60	4.50
D1	1.62	1.83	1.733
D2	1.61	1.81	1.71
E	2.40	2.60	2.50
E2	2.05	2.35	2.20
e	-	-	1.50
H	3.95	4.25	4.10
H1	2.63	2.93	2.78
L	0.90	1.20	1.05
L1	0.327	0.527	0.427
z	0.20	0.40	0.30
All Dimensions in mm			

**Suggested Pad Layout**

Please see <http://www.diodes.com/package-outlines.html> for the latest version.

**SOT89**

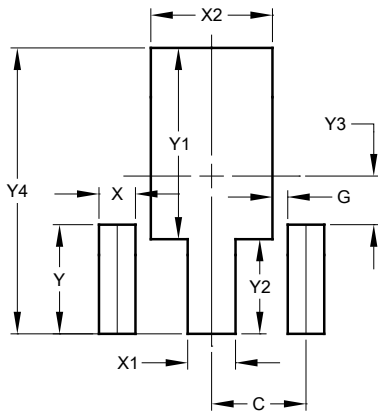

Dimensions	Value (in mm)
C	1.500
G	0.244
X	0.580
X1	0.760
X2	1.933
Y	1.730
Y1	3.030
Y2	1.500
Y3	0.770
Y4	4.530

**IMPORTANT NOTICE**

1. DIODES INCORPORATED AND ITS SUBSIDIARIES (“DIODES”) MAKE NO WARRANTY OF ANY KIND, EXPRESS OR IMPLIED, WITH REGARDS TO ANY INFORMATION CONTAINED IN THIS DOCUMENT, INCLUDING, BUT NOT LIMITED TO, THE IMPLIED WARRANTIES OF MERCHANTABILITY, FITNESS FOR A PARTICULAR PURPOSE OR NON-INFRINGEMENT OF THIRD PARTY INTELLECTUAL PROPERTY RIGHTS (AND THEIR EQUIVALENTS UNDER THE LAWS OF ANY JURISDICTION).
2. The Information contained herein is for informational purpose only and is provided only to illustrate the operation of Diodes products described herein and application examples. Diodes does not assume any liability arising out of the application or use of this document or any product described herein. This document is intended for skilled and technically trained engineering customers and users who design with Diodes products. Diodes products may be used to facilitate safety-related applications; however, in all instances customers and users are responsible for (a) selecting the appropriate Diodes products for their applications, (b) evaluating the suitability of the Diodes products for their intended applications, (c) ensuring their applications, which incorporate Diodes products, comply the applicable legal and regulatory requirements as well as safety and functional-safety related standards, and (d) ensuring they design with appropriate safeguards (including testing, validation, quality control techniques, redundancy, malfunction prevention, and appropriate treatment for aging degradation) to minimize the risks associated with their applications.
3. Diodes assumes no liability for any application-related information, support, assistance or feedback that may be provided by Diodes from time to time. Any customer or user of this document or products described herein will assume all risks and liabilities associated with such use, and will hold Diodes and all companies whose products are represented herein or on Diodes’ websites, harmless against all damages and liabilities.
4. Products described herein may be covered by one or more United States, international or foreign patents and pending patent applications. Product names and markings noted herein may also be covered by one or more United States, international or foreign trademarks and trademark applications. Diodes does not convey any license under any of its intellectual property rights or the rights of any third parties (including third parties whose products and services may be described in this document or on Diodes’ website) under this document.
5. Diodes products are provided subject to Diodes’ Standard Terms and Conditions of Sale (<https://www.diodes.com/about/company/terms-and-conditions/terms-and-conditions-of-sales/>) or other applicable terms. This document does not alter or expand the applicable warranties provided by Diodes. Diodes does not warrant or accept any liability whatsoever in respect of any products purchased through unauthorized sales channel.
6. Diodes products and technology may not be used for or incorporated into any products or systems whose manufacture, use or sale is prohibited under any applicable laws and regulations. Should customers or users use Diodes products in contravention of any applicable laws or regulations, or for any unintended or unauthorized application, customers and users will (a) be solely responsible for any damages, losses or penalties arising in connection therewith or as a result thereof, and (b) indemnify and hold Diodes and its representatives and agents harmless against any and all claims, damages, expenses, and attorney fees arising out of, directly or indirectly, any claim relating to any noncompliance with the applicable laws and regulations, as well as any unintended or unauthorized application.
7. While efforts have been made to ensure the information contained in this document is accurate, complete and current, it may contain technical inaccuracies, omissions and typographical errors. Diodes does not warrant that information contained in this document is error-free and Diodes is under no obligation to update or otherwise correct this information. Notwithstanding the foregoing, Diodes reserves the right to make modifications, enhancements, improvements, corrections or other changes without further notice to this document and any product described herein. This document is written in English but may be translated into multiple languages for reference. Only the English version of this document is the final and determinative format released by Diodes.
8. Any unauthorized copying, modification, distribution, transmission, display or other use of this document (or any portion hereof) is prohibited. Diodes assumes no responsibility for any losses incurred by the customers or users or any third parties arising from any such unauthorized use.

Copyright © 2020 Diodes Incorporated

[www.diodes.com](http://www.diodes.com)