



**SPECIFICATION SHEET**

<b>SPECIFICATION SHEET NO.</b>	N0623- YR32K76800S001
<b>DATE</b>	June 23, 2021
<b>REVISION</b>	A1
<b>DESCRIPTION</b>	<p>KHz SMD Crystals, L3.2*W1.5*H0.9mm, 2 Pads, CCMM series            32.76800KHz, +/-20ppm, CL 12.5pF            Operating Temp. Range -40°C ~+85°C, ESR 70 Kohm Max,            Reflow Profile Condition 260 °C Max.            Tape/Reel, 3000pcs/Reel,            RoHS/RoHS III compliant</p>
<b>CUSTOMER</b>	
<b>CUSTOMER PART NUMBER</b>	
<b>CROSS REF. PART NUMBER</b>	
<b>ORIGINAL PART NUMBER</b>	TGS CCMM 32K768A20-12.5-40-70T LF
<b>PART CODE</b>	YR32K76800S001

<b>VENDOR APPROVE</b>			
Issued/Checked/Approved			
DATE: June 23, 2021			

<b>CUSTOMER APPROVE</b>	
DATE:	

**KHZ SMD CRYSTALS CCMM SERIES 3215 TYPE**

**MAIN FEATURE**

- SMD Package, CCMM Series, L3.2\*W1.5\*H0.9mm, 2 Pads
- Industry standard
- Reflow Profile Condition 260 °C Max.
- Cross more competitors part
- RoHS/RoHS III compliant



**APPLICATION**

- Small communications devices and more

**PART CODE GUIDE**

**RFQ**  
Request For Quotation

<b>YR</b>	<b>32K76800</b>	<b>S</b>	<b>001</b>
1	2	3	4

- 1) YR: Part family Code for KHz SMD crystal L3.2\*W1.5\*H0.9mm, 2 Pads, CCMM series
- 2) 32K76800: Frequency range code for 32.76800KHz
- 3) S: SMD type, Package Tape/Reel, 3000pcs/Reel
- 4) 001: Specification code for original part No.: **TGS CCMM 32K768A20-12.5-40-70T LF**

**KHZ SMD CRYSTALS CCMM SERIES 3215 TYPE**

**DIMENSION (Unit: mm)**

Image for reference

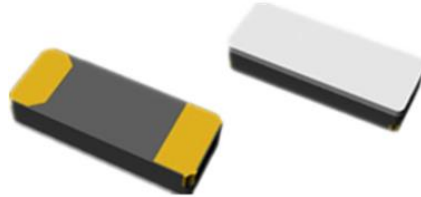

CCMM

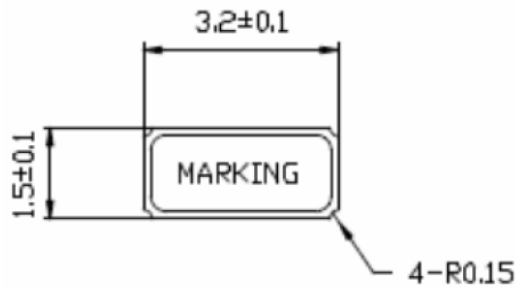

**Marking**  
Frequency Range

or

**Marking**  
Internal Control Code

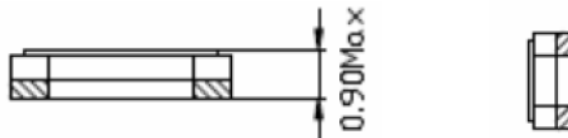
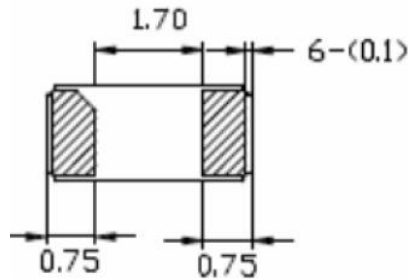

Land Pattern  
for reference



**KHZ SMD CRYSTALS CCMM SERIES 3215 TYPE**

**PRODUCT STRUCTURE**

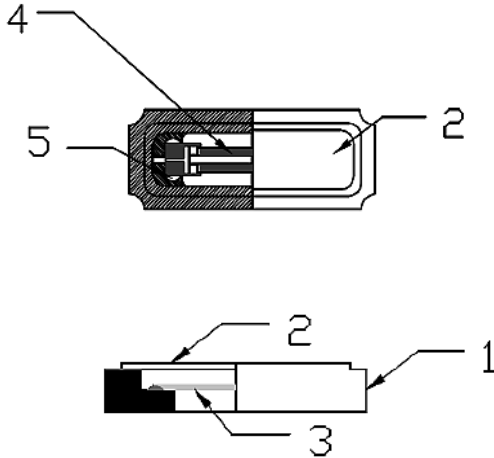

Item No.	Component Name	Material Name
1	Crystal Case	Ceramic (A1203)
2	Crystal Cover/Lid	KV (Fe/Co/Ni)
3	Crystal Chip/Blank	SiO2
4	Electrode	Au, Ag
5	Adhesive	Resin, Ag

**EQUIVALENT CIRCUIT**

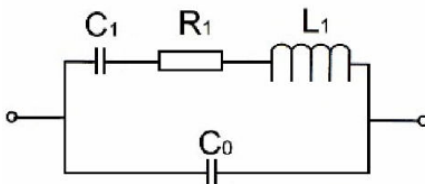

**NOTES BEFORE USE**

**Ultrasonic Cleaning:**

General cleaning solutions or ultrasonic cleaning method may be used to clean our products. However, under certain circumstances, ultrasonic cleaning machine could generate resonance at the oscillation frequency of our products and thus deteriorate the electrical characteristics in device and even damage the overall structure of device. Therefore, verification test is recommended before cleaning.

**Ultrasonic Welding**

Avoid mounting and processing by Ultrasonic welding this method has a possibility of an excessive vibration spreading inside the crystal products and become the cause of characteristic deterioration and not oscillating.

**Storage Temperature Description**

Storage Temperature is only for the product itself, the temperature for the packing material is 5~40°C

Recommended Conditions for Manual Welding Max. Temperature: 350±10°C, Time: 3 sec Max., Re-solder time: twice Max.

## KHZ SMD CRYSTALS CCMM SERIES 3215 TYPE

**ELECTRICAL PARAMETERS**

Parameter	Part No. Symbol	Units	Value			Condition
			Min.	Typical	Max.	
Original Manufacturer	TGS		TGS Crystals			
Holder Type	CCMM		KHz SMD Crystal L3.2*W1.5*H0.9mm, 2 Pads			
Frequency Range	32K768	KHz	32.76800			
Mode of Oscillation	A		AT Fundamental			
Frequency Tolerance	20	ppm	-20		+20	@25°C
Load Capacitance	-12.5	pF	12.5			
Frequency/Temp Coefficient		ppm/°C <sup>2</sup>	-0.02	-	0.04	
Operation Temperance	-40	°C	-40		+85	
Storage Temperance		°C	-55		+125	
Equivalent Series Resistance (ESR)	-70	KΩ			70	
Drive Level		μW			0.5	
Shunt Capacitance (C0)		pF		1.1	2.0	
Dynamic Capacitance (C1)		fF		4.1		
Turnover Temp		°C	+20	+25	+30	
Quality Factor			60000			
Capacitance Ratio			450			
Aging		ppm/year			±3	@1 <sup>st</sup> year
Insulation Resistance		MΩ	500			@100Vdc ± 15VDC
Other	Package	T	Tape/Reel, 3000pcs/Reel			
	RoHS Status	LF	RoHS III compliant			
	Add Value		N/A			
	Special Code*		2 letter or digits; Blank: N/A			

Note: 1) Original Part Number: **TGS CCMM 32K768A20-12.5-40-70T LF**

2) \* Internal Control Code- 2 letter or digits; Blank: N/A

**KHZ SMD CRYSTALS CCMM SERIES 3215 TYPE**
**RELIABILITY**

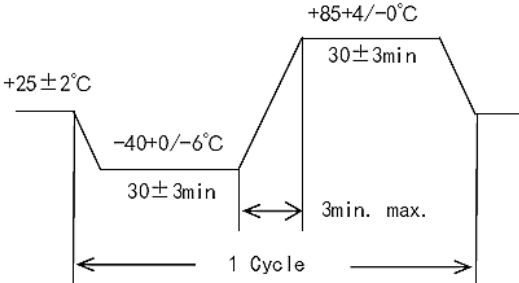
Test Items	Test Method And Conditions	Test Standard
<b>High Temperature High Humidity Storage</b>	Temperature: $60^{\circ}\text{C} \pm 2^{\circ}\text{C}$ Relative Humidity: 90%~95% RH For Time: $500 \pm 12$ Hours	A, C, D, G
<b>High Temperature Storage</b>	Temperature: $125^{\circ}\text{C} \pm 2^{\circ}\text{C}$ Time: $1000 \pm 12$ Hours.	B, C, G
<b>Low Temperature Storage</b>	Temperature: $-40^{\circ}\text{C} \pm 2^{\circ}\text{C}$ Time: $500 \pm 12$ Hours.	A, C, G
<b>Temperature Cycle</b>	<p>The crystal unit shall be subjected to 100 successive change of temperature cycles.</p> 	A, C, G
<b>Solderability</b>	The solder pot temperature is $260 \pm 5^{\circ}\text{C}$ , dwell time $2 \pm 0.6$ sec	F
<b>Drop Test</b>	Height: 180 cm; Dropped Cycle: 3 cycles; Drop it on to a concrete board for 6 Directions (X,Y,Z), that should be 1 cycle	B, C
<b>Vibration</b>	Frequency Range: 10Hz ~ 55Hz Amplitude: $1.5\text{mm} \pm 15\%$ ; Sweep time: 2~3 Minutes, 2 Hours in each direction, total 6 Hours	A, C
<b>Leakage Test</b>	Helium Bombing $5.0 \sim 5.5$ Kgf/cm <sup>2</sup> ; for 2 hours	E

## KHZ SMD CRYSTALS CCMM SERIES 3215 TYPE

**RELIABILITY**

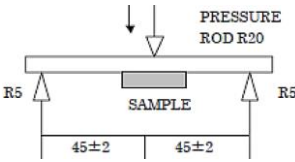
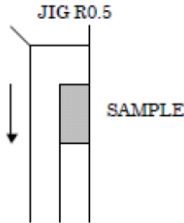
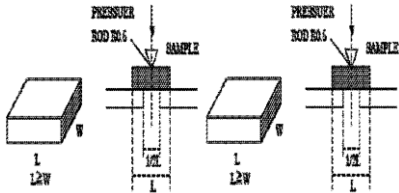
Test Items	Test Method And Conditions	Test Standard
<b>Terminal Strength</b>	Shall be pressurized at a speed of approx. 0.5mm/sec. in the direction indicated by the arrow unit the bending width reaches 3mm and held for 5 sec. 	B, C
<b>Sticking Tendency</b>	A R0.5 Jig shall be used to apply a 10N dead load in the direction indicated by the arrow to the element and retain it for 10 sec. 	B, C
<b>Element Assembly Strength</b>	A R0.5 Jig shall be used to apply a 10N dead load in the direction indicated by the arrow to the element and retain it for 10 sec. 	B, C

**TEST STANDARD**

Test Standard Symbol	Specification	Value
A	Frequency Change permitted	$\Delta F \leq 10 \text{ppm}$
B	Frequency Change permitted	$\Delta F \leq 20 \text{ppm}$
C	Equivalent Series Resistance Change Permitted	$\Delta C I \leq 5 \text{K}\Omega$ or 20%
D	Insulation Resistance	$> 500 \text{ M}\Omega$
E	Leak Rate Less than	$< 1 \cdot 1 \text{E-}9 \text{ Pa} \cdot \text{m}^3/\text{sec.}$
F	A new uniform coating of solder shall cover a Min 95% of the crystal surface	
G	Then $25 \pm 2^\circ\text{C}$ over 2 hours before Testing	

**KHZ SMD CRYSTALS CCMM SERIES 3215 TYPE**

**SUGGESTED REFLOW PROFILE (For Reference No. JEDEC J-STD-020D)**

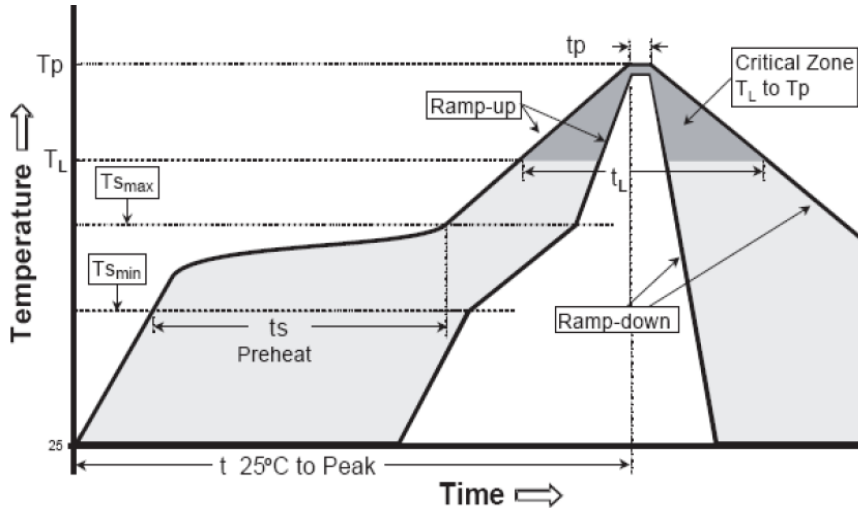

<b>Profile Feature</b>		Pb-Free Assembly
<b>Average Ramp-up Rate (Ts Max to Tp)</b>		3°C/second Max
<b>Preheat</b>	<b>Temperature Min (Ts Min.)</b>	150°C
	<b>Temperature Max (Ts Max.)</b>	200°C
	<b>Time (ts Min. to ts Max.)</b>	60 ~ 120 seconds
<b>Time maintained above</b>	<b>Temperature (T<sub>L</sub>)</b>	217°C
	<b>Time (t<sub>L</sub>)</b>	60 ~ 150 seconds
<b>Peak/Classification Temperature (T<sub>p</sub>)</b>		260 +/-5°C
<b>Time within 5°C of actual Peak Temperature (t<sub>p</sub>)</b>		20 ~ 40 seconds
<b>Ramp-down rate</b>		6 °C /Second Max.
<b>Time 25 °C to Peak Temperature</b>		8 minutes Max.
<b>Suggest reflow times</b>		3 Times Max.



**KHZ SMD CRYSTALS CCMM SERIES 3215 TYPE**

**TAPE/REEL (Unit: mm)**

All Devices are packed in accordance with EIA standard RS-481-2 and specifications, 3000pcs/Reel

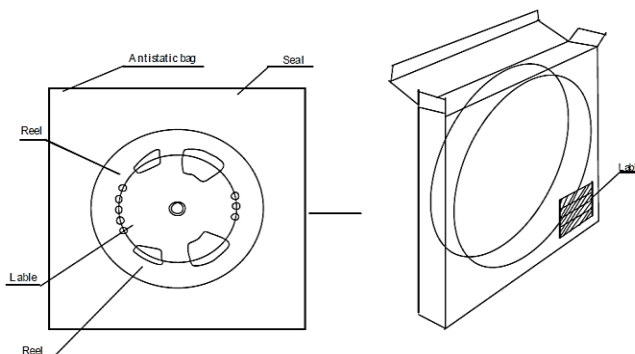
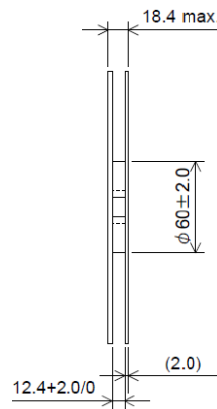
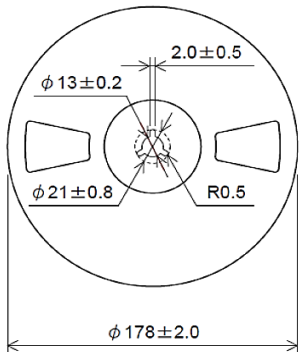
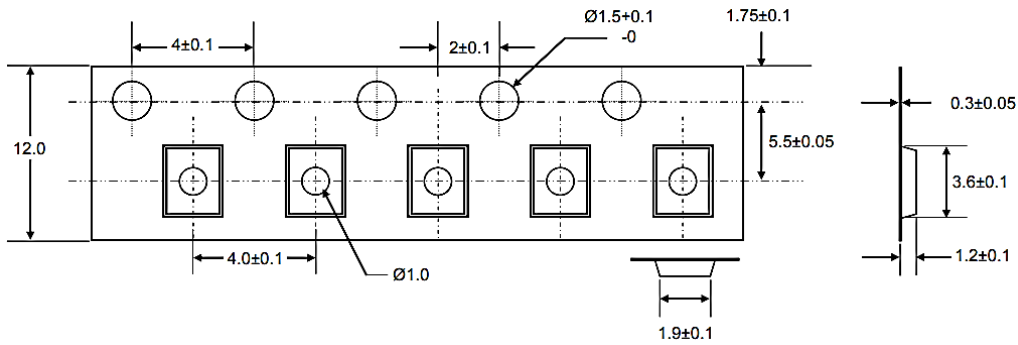

**DISCLAIMER**

NextGen Components, Inc. reserves the right to make changes to the product(s) and or information contained herein without notice. No liability is assumed as a result of their use or application. No rights under any patent accompany the sale of any such product(s) or information.