

Antenna

YC0003AA Datasheet

Antenna Services

Version: 3.0

Date: 2021-07-13

Status: Released



Our aim is to provide customers with timely and comprehensive service. For any assistance, please contact our company headquarters:

Quectel Wireless Solutions Co., Ltd.

Building 5, Shanghai Business Park Phase III (Area B), No.1016 Tianlin Road, Minhang District, Shanghai 200233, China

Tel: +86 21 5108 6236

Email: info@quectel.com

Or our local office. For more information, please visit:

<http://www.quectel.com/support/sales.htm>.

For technical support, or to report documentation errors, please visit:

<http://www.quectel.com/support/technical.htm>

Or email to support@quectel.com.

General Notes

Quectel offers the information as a service to its customers. The information provided is based upon customers' requirements. Quectel makes every effort to ensure the quality of the information it makes available. Quectel does not make any warranty as to the information contained herein, and does not accept any liability for any injury, loss or damage of any kind incurred by use of or reliance upon the information. All information supplied herein is subject to change without prior notice.

Disclaimer

While Quectel has made efforts to ensure that the functions and features under development are free from errors, it is possible that these functions and features could contain errors, inaccuracies and omissions. Unless otherwise provided by valid agreement, Quectel makes no warranties of any kind, implied or express, with respect to the use of features and functions under development. To the maximum extent permitted by law, Quectel excludes all liability for any loss or damage suffered in connection with the use of the functions and features under development, regardless of whether such loss or damage may have been foreseeable.

Duty of Confidentiality

The Receiving Party shall keep confidential all documentation and information provided by Quectel, except when the specific permission has been granted by Quectel. The Receiving Party shall not access or use Quectel's documentation and information for any purpose except as expressly provided herein. Furthermore, the Receiving Party shall not disclose any of the Quectel's documentation and information to any third party without the prior written consent by Quectel. For any noncompliance to the above requirements, unauthorized use, or other illegal or malicious use of the documentation and information, Quectel will reserve the right to take legal action.

Copyright

The information contained here is proprietary technical information of Quectel. Transmitting, reproducing, disseminating and editing this document as well as using the content without permission are forbidden. Offenders will be held liable for payment of damages. All rights are reserved in the event of a patent grant or registration of a utility model or design.

Copyright © Quectel Wireless Solutions Co., Ltd. 2021. All rights reserved.

About the Document

Revision History

Version	Date	Author	Note
1.0	2020-06-23	Kenny YIN	Initial
2.0	2020-08-28	Kenny YIN	Updated the specifications.
2.1	2020-12-11	Kenny YIN	Updated the antenna image in Chapter 2.
2.2	2021-01-14	Kenny YIN	Added the coordinate picture of the product in the lab.
2.3	2021-01-15	Kenny YIN	Added the return loss and package information.
2.4	2021-01-20	Kenny YIN	Updated the direction map.
2.5	2021-03-17	Kenny YIN	Updated the product height tolerance (Chapter 12).
3.0	2021-07-13	Aria CHU	Updated all test data in this datasheet.

Contents

About the Document.....	3
Contents.....	4
1 Product Description.....	5
2 Product Features	5
3 Product Specifications	6
4 Overall Performance.....	7
4.1. Test Environment	7
4.2. VSWR.....	8
4.3. Efficiency	9
4.4. Gain.....	10
4.5. Radiation Pattern	11
4.5.1. 135 mm x 40 mm (PCB Evaluation Board)	12
4.5.1.1. 700 MHz	12
4.5.1.2. 820 MHz	13
4.5.1.3. 960 MHz	14
4.5.1.4. 1710 MHz	15
4.5.1.5. 2170 MHz	16
4.5.1.6. 2300 MHz	17
4.5.1.7. 2690 MHz	18
5 Schematic Symbol and Pin Definition	19
6 Transmission Line	19
7 Recommend PCB Layout.....	20
8 Matching Circuit.....	21
9 Soldering Temperature.....	21
10 Reflow Profile	22
11 Package.....	23
12 Product Size (Unit: mm).....	24

1 Product Description

The antenna is designed for superior performance, and can be widely used for wireless applications.

We provide comprehensive antenna design support such as simulation, testing and manufacturing for custom antenna solutions to meet your specific application needs.

2 Product Features

- LTE
- High efficiency
- Excellent performance

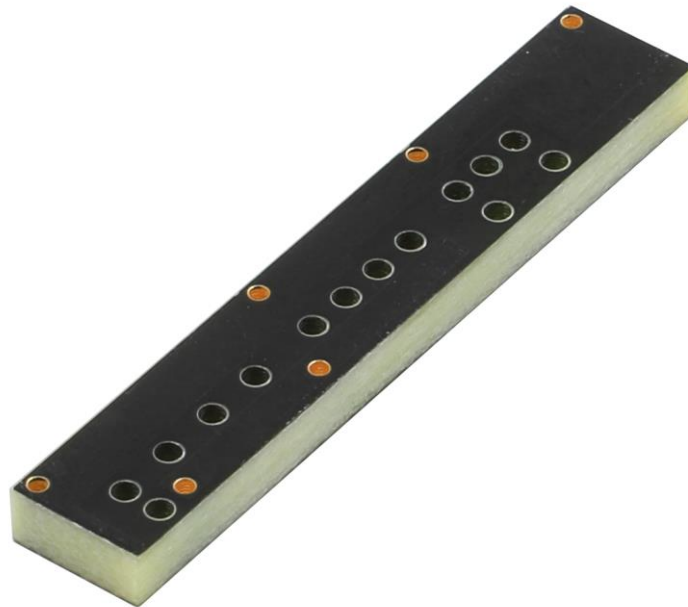

3 Product Specifications

Passive Electrical Specifications

Frequency Range	698–960 MHz, 1695–2200 MHz, 2300–2700 MHz
Input Impedence	50 Ω
VSWR	135 mm x 40 mm < 4.0
	125 mm x 40 mm < 5.0
	115 mm x 40 mm < 5.0
	105 mm x 40 mm < 5.0
	95 mm x 40 mm < 6.0
	85 mm x 40 mm < 6.0
75 mm x 40 mm < 7.0	
Gain	< 6.0 dBi
Polarization Type	Linear

Mechanical Specifications

Antenna Size	40 mm (L) x 7 mm (W) x 3 mm (H)
Carrier	FR4
Connector Type	SMD
Working Temperature	-40 °C to +85 °C
Radome Color	Black

4 Overall Performance

4.1. Test Environment

- KEYSIGHT VNA Network Analyzer E5063A 100 kHz – 8.5 GHz
- RayZone® 2800 Chamber 5G (FR1) SISO/MIMO, 400 MHz – 8.0 GHz



- Antenna on PCB evaluation board with different length:
 - 135 mm x 40 mm
 - 125 mm x 40 mm
 - 115 mm x 40 mm
 - 105 mm x 40 mm
 - 95 mm x 40 mm
 - 85 mm x 40 mm
 - 75 mm x 40 mm

4.2. VSWR

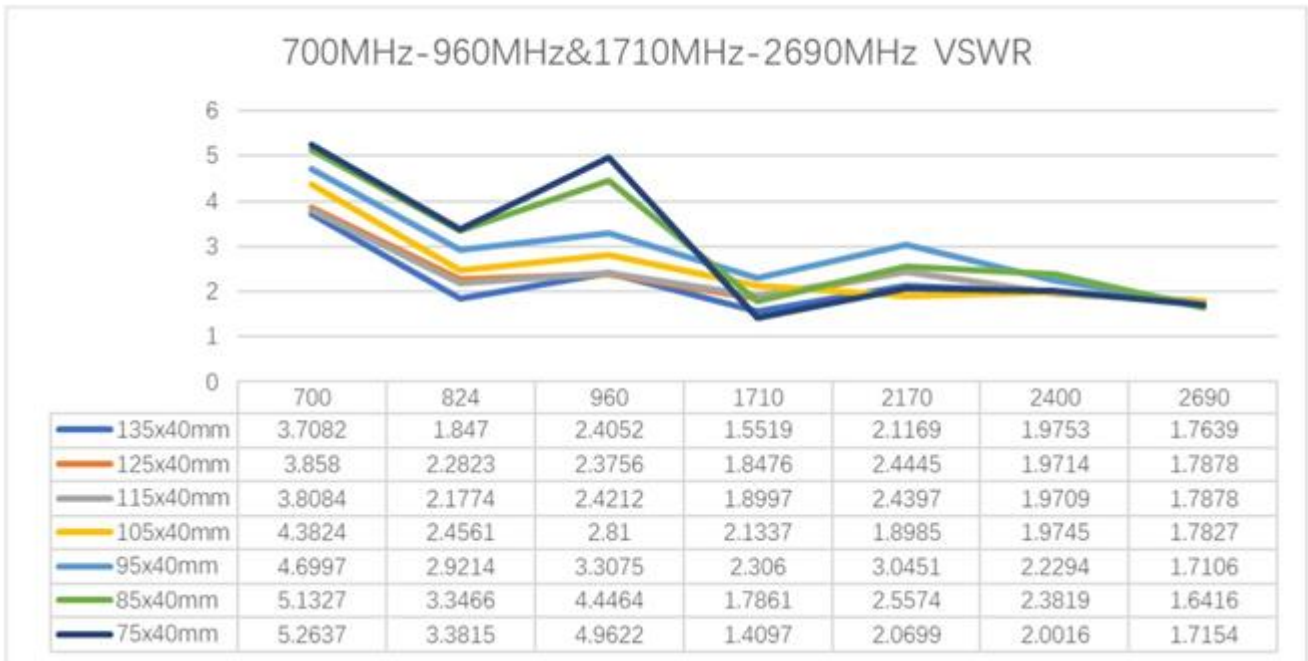

Frequency (MHz)	700	820	960	1710	2170	2400	2690
VSWR < 4.0 (135 mm x 40 mm)	3.70	1.84	2.40	1.55	2.11	1.97	1.76
VSWR < 5.0 (125 mm x 40 mm)	3.85	2.28	2.37	1.84	2.44	1.97	1.78
VSWR < 5.0 (115 mm x 40 mm)	3.80	2.17	2.42	1.89	2.43	1.97	1.78
VSWR < 5.0 (105 mm x 40 mm)	4.38	2.45	3.06	2.13	1.89	1.97	1.78
VSWR < 6.0 (95 mm x 40 mm)	4.69	2.92	3.79	2.30	3.04	2.22	1.71
VSWR < 6.0 (85 mm x 40 mm)	5.13	3.34	3.97	1.78	2.55	2.38	1.64
VSWR < 7.0 (75 mm x 40 mm)	5.26	3.38	5.32	1.40	2.06	2.00	1.71

4.3. Efficiency

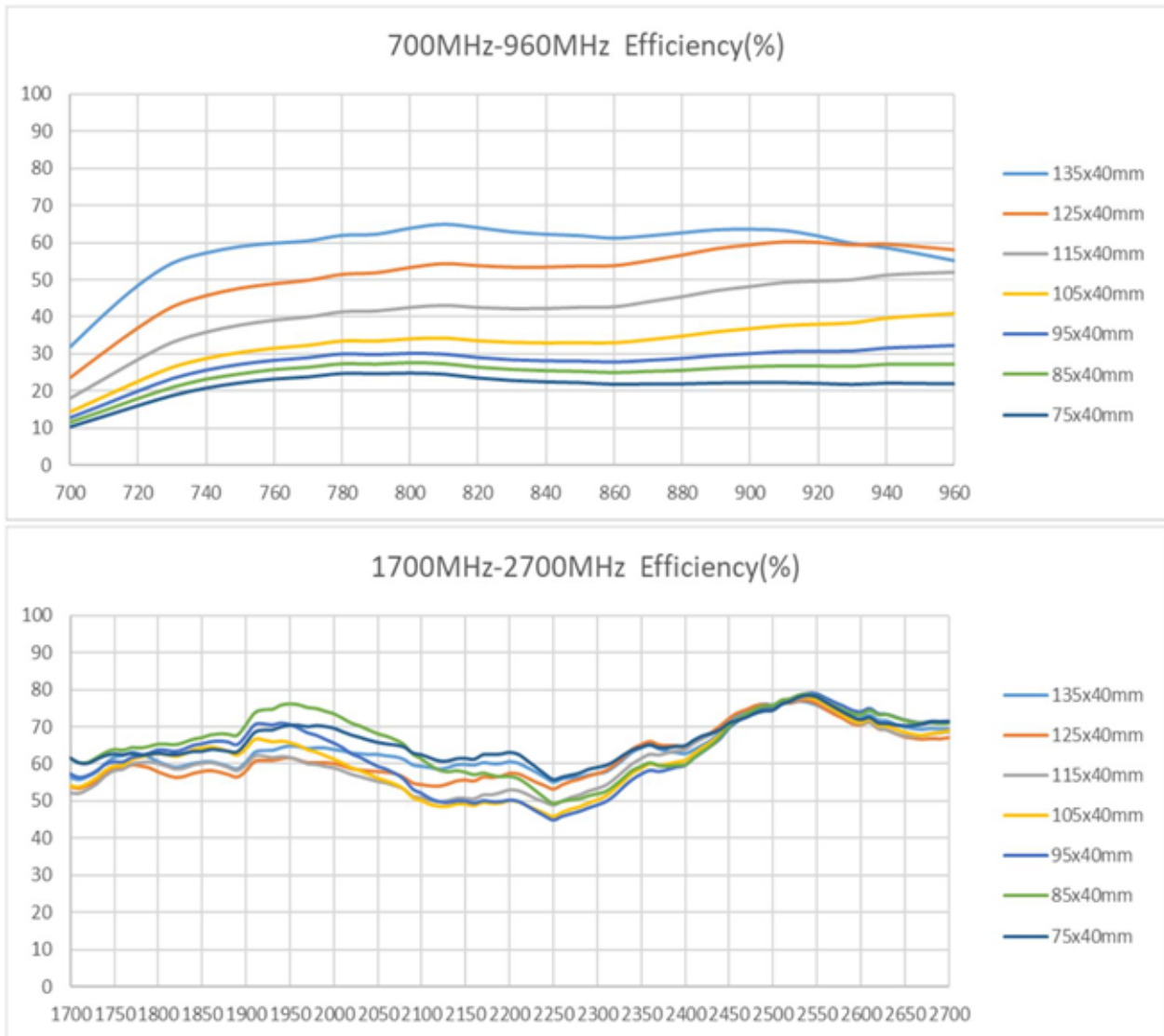

Frequency (MHz)	700	820	960	1710	2170	2400	2690
Efficiency (135 mm x 40 mm)	32%	64%	55%	56%	60%	63%	69%
Efficiency (125 mm x 40 mm)	24%	54%	58%	53%	56%	65%	67%
Efficiency (115 mm x 40 mm)	18%	43%	54%	52%	52%	64%	68%
Efficiency (105 mm x 40 mm)	15%	34%	52%	54%	50%	61%	68%
Efficiency (95 mm x 40 mm)	13%	29%	32%	56%	50%	60%	72%
Efficiency (85 mm x 40 mm)	12%	26%	27%	60%	58%	60%	71%
Efficiency (75 mm x 40 mm)	11%	24%	22%	60%	63%	65%	71%

4.4. Gain

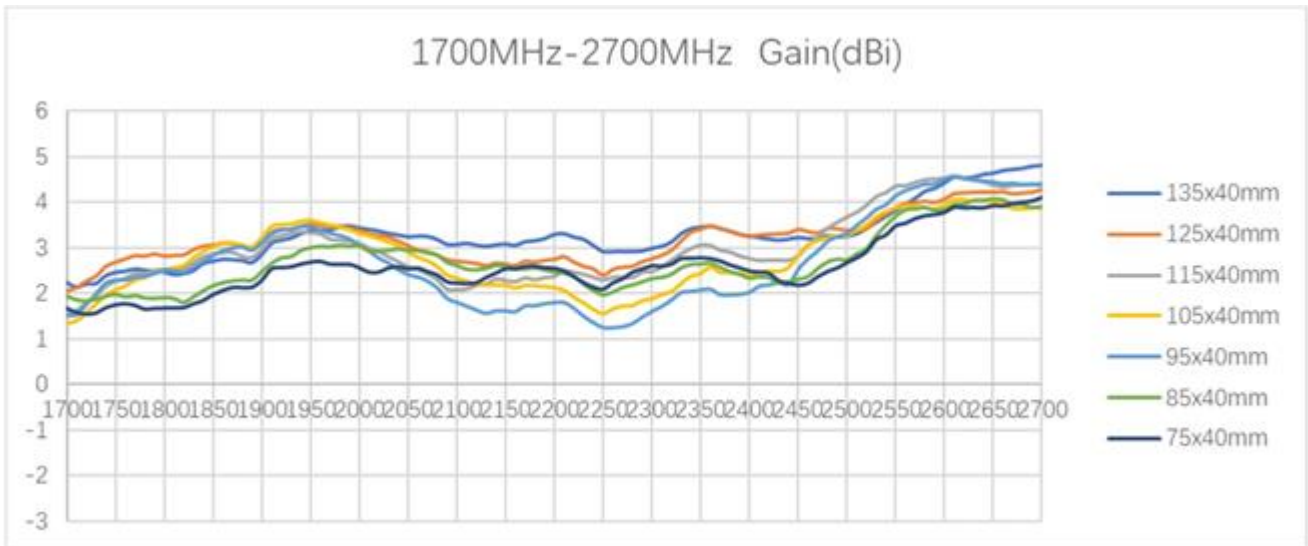
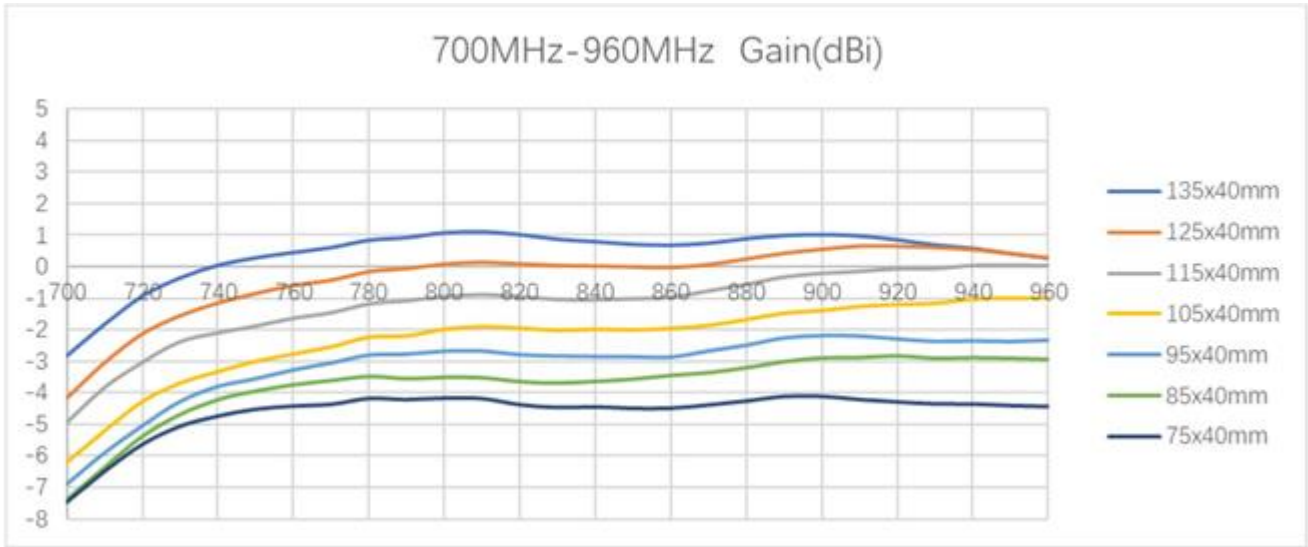

Frequency (MHz)	700	820	960	1710	2170	2400	2690
Gain < 6 dBi (135 mm x 40 mm)	-2.8	1.02	0.29	2.13	3.13	3.26	4.80
Gain < 6 dBi (125 mm x 40 mm)	-4.17	0.10	0.29	2.11	2.69	3.23	4.21
Gain < 6 dBi (115 mm x 40 mm)	-4.94	-0.95	0.02	1.61	2.32	2.75	4.38
Gain < 6 dBi (105 mm x 40 mm)	-6.22	-1.93	-0.99	1.39	2.17	2.39	3.86
Gain < 6 dBi (95 mm x 40 mm)	-6.91	-2.80	-2.34	1.53	1.73	2.02	4.38
Gain < 6 dBi (85 mm x 40 mm)	-7.39	-3.66	-2.95	1.86	2.53	2.34	3.88
Gain < 6 dBi (75 mm x 40 mm)	-7.45	-4.36	-4.42	1.56	2.57	2.47	4.01

4.5. Radiation Pattern

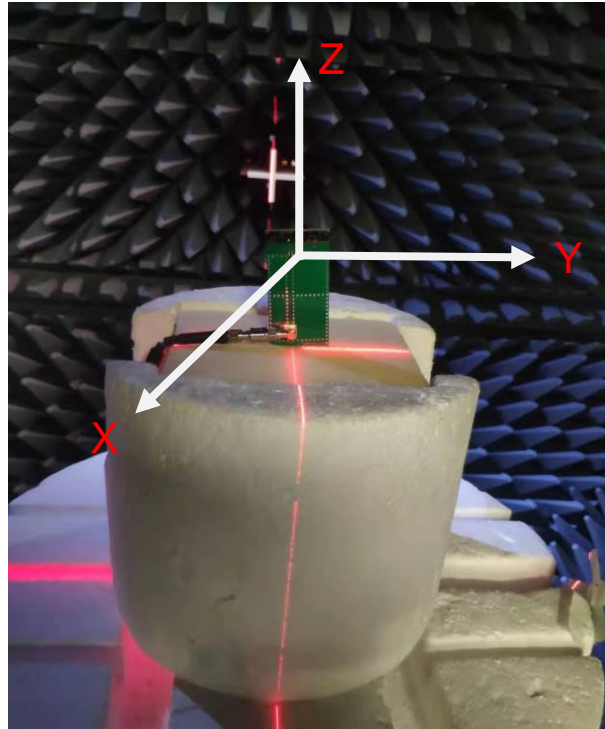

H plane: the tangent of XY
E1 plane: the tangent of XZ
E2 plane: the tangent of YZ

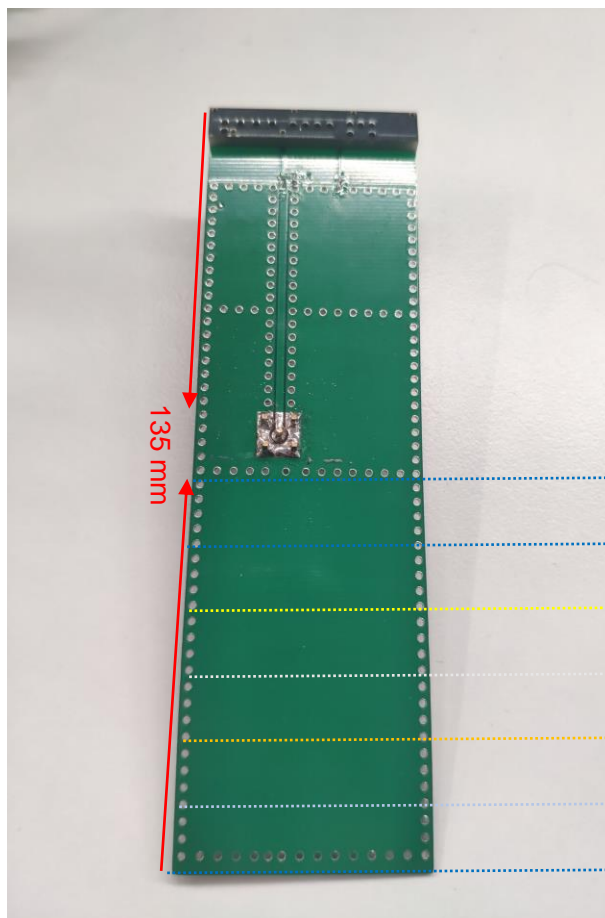

135 mm

- ▶ 75 mm x 40 mm
- ▶ 85 mm x 40 mm
- ▶ 95 mm x 40 mm
- ▶ 105 mm x 40 mm
- ▶ 115 mm x 40 mm
- ▶ 125 mm x 40 mm
- ▶ 135 mm x 40 mm

4.5.1. 135 mm × 40 mm (PCB Evaluation Board)

4.5.1.1. 700 MHz

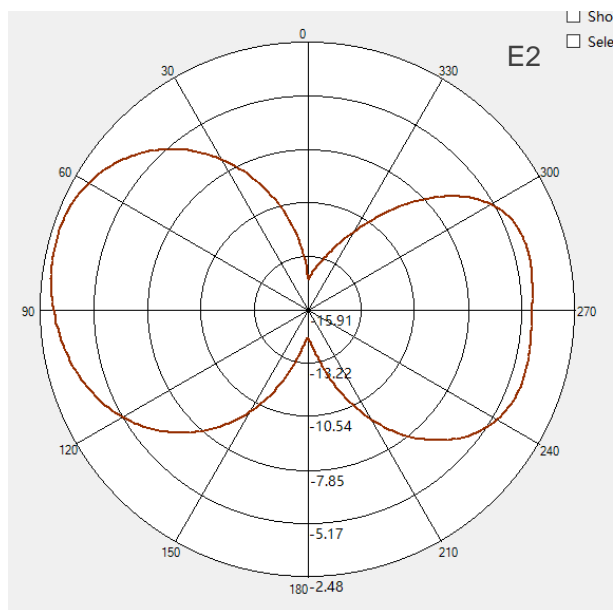
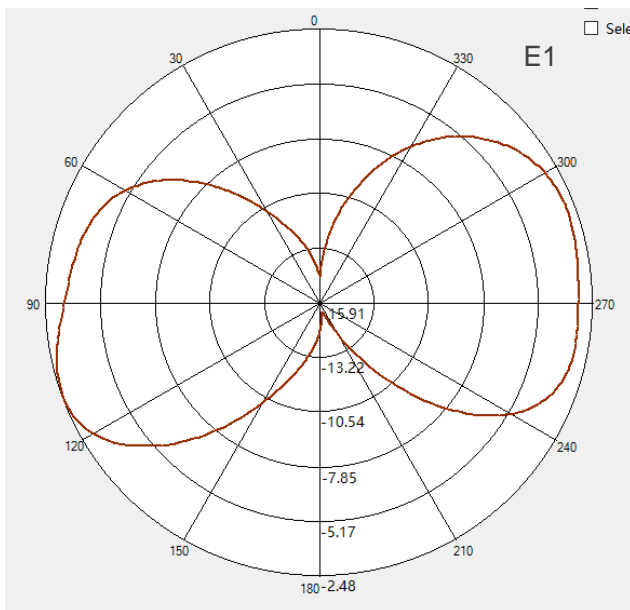
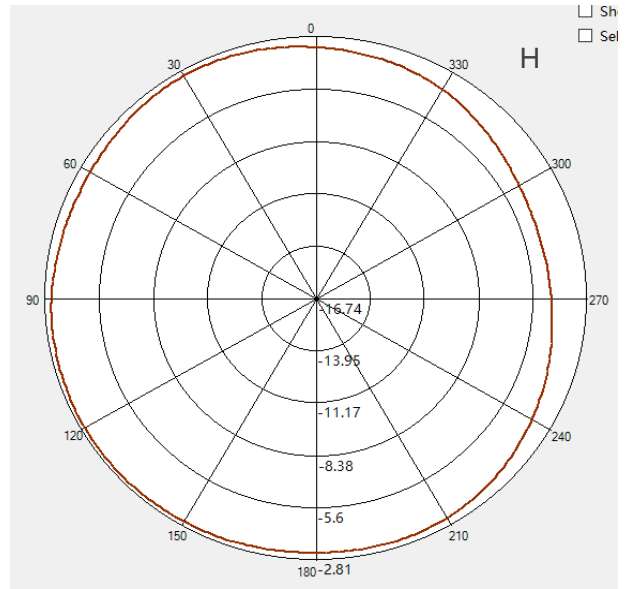
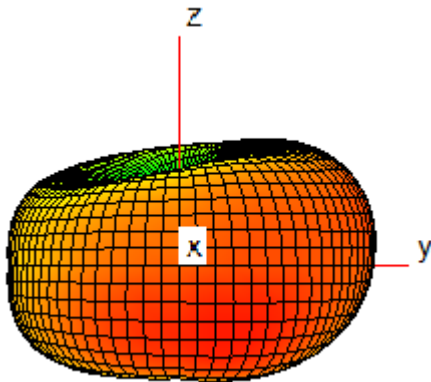

4.5.1.2. 820 MHz

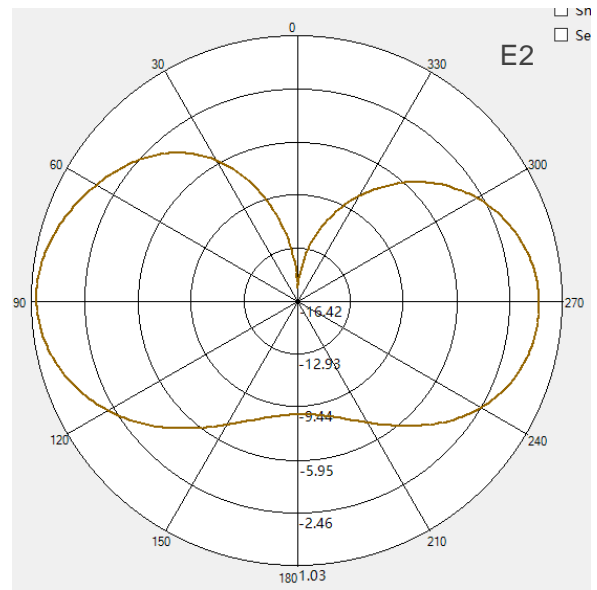
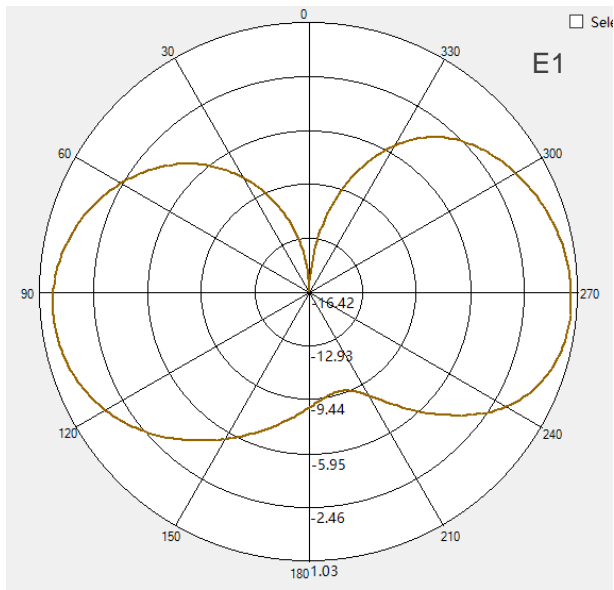
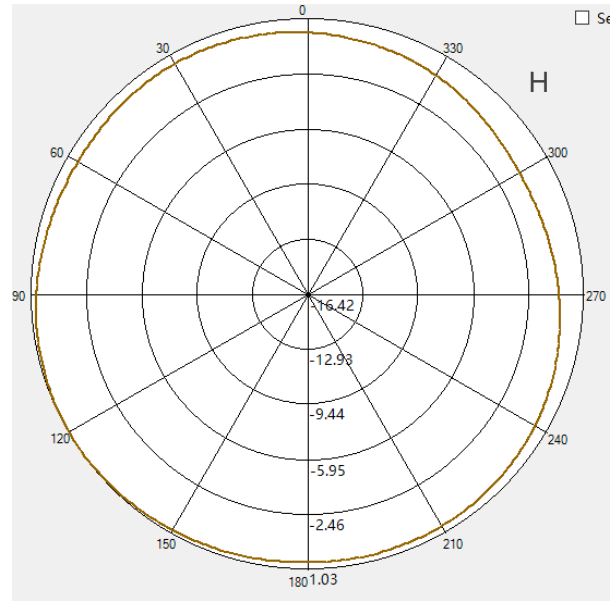
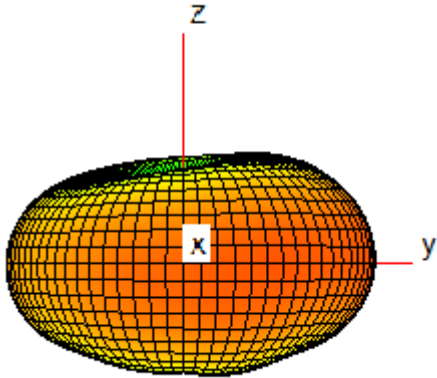

4.5.1.3. 960 MHz

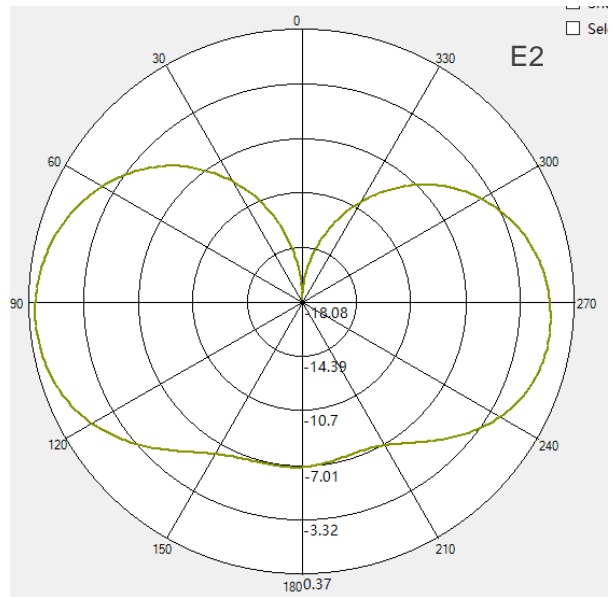
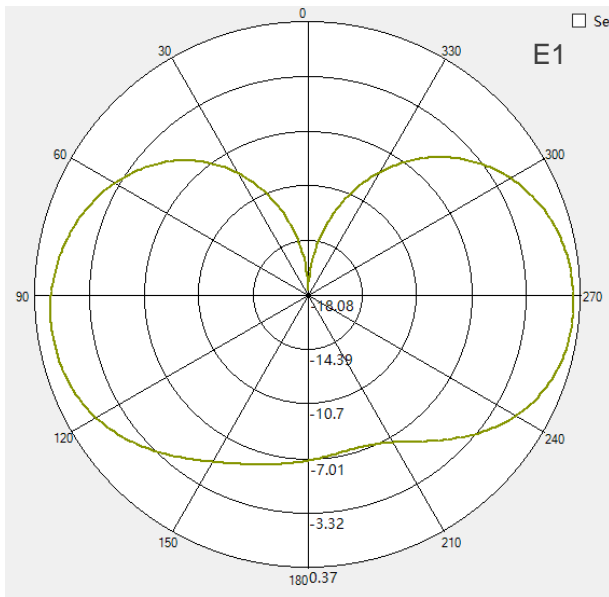
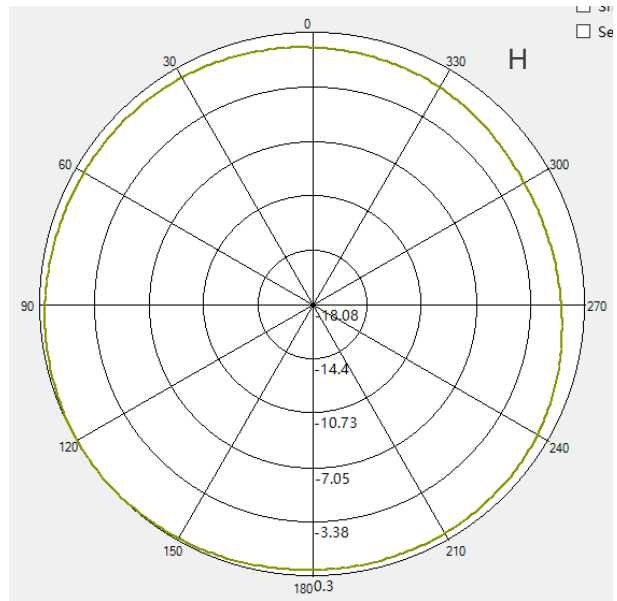
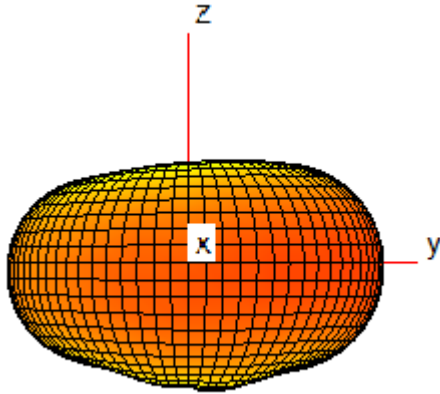

4.5.1.4. 1710 MHz

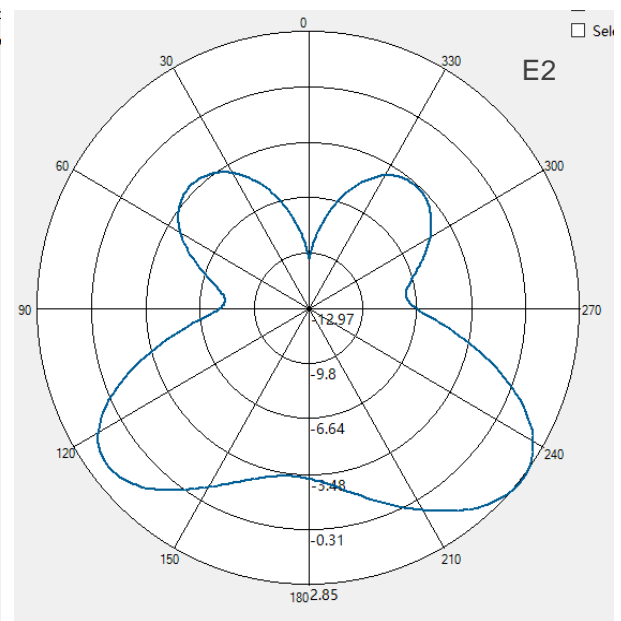
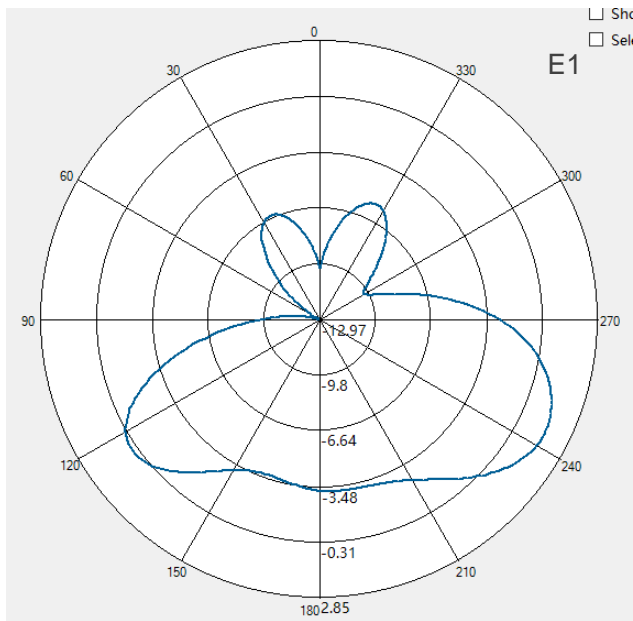
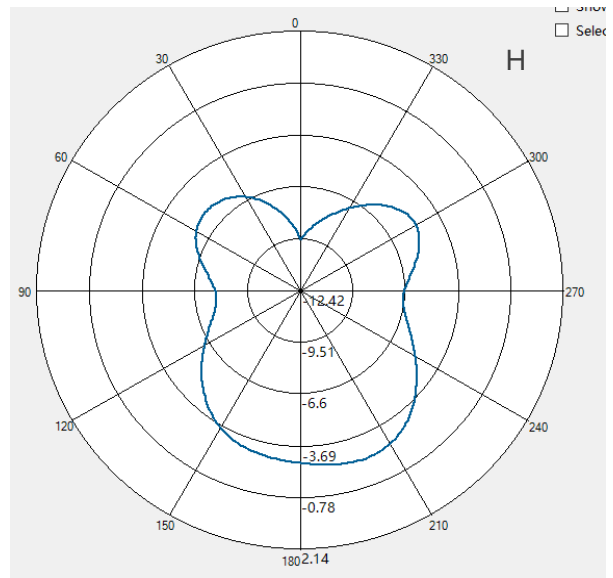
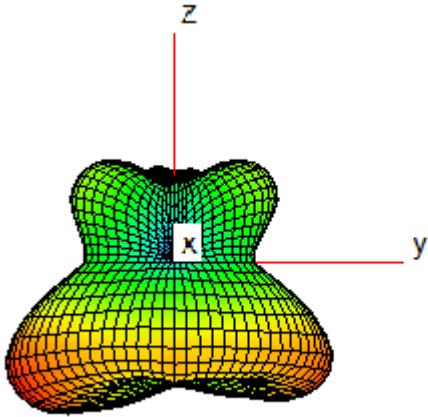

4.5.1.5. 2170 MHz

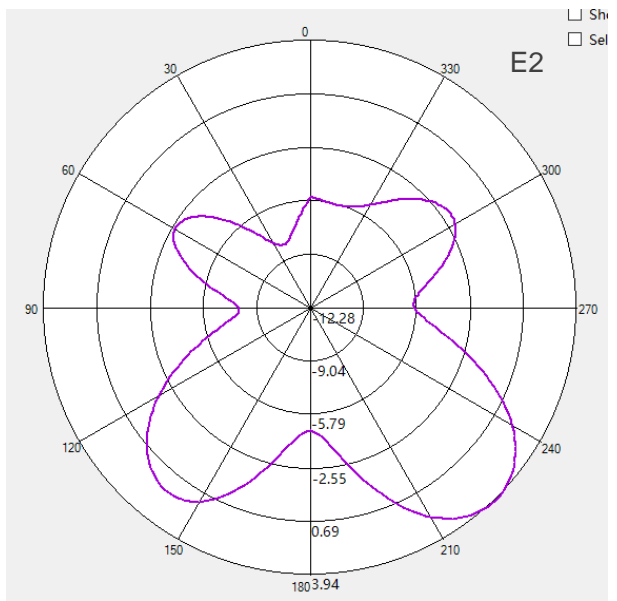
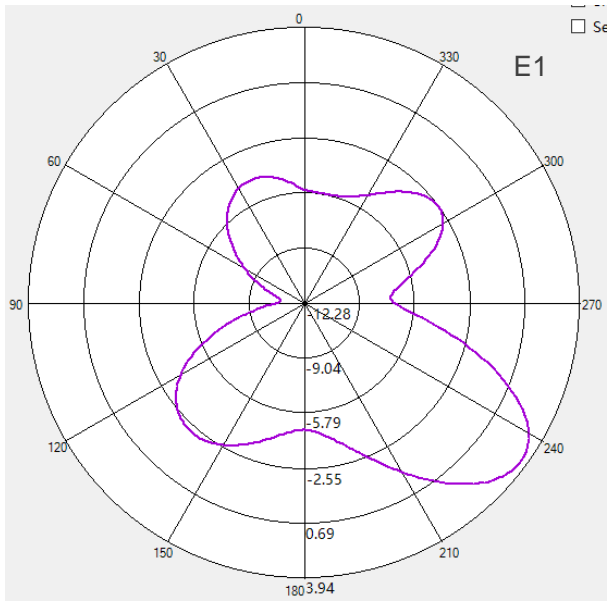
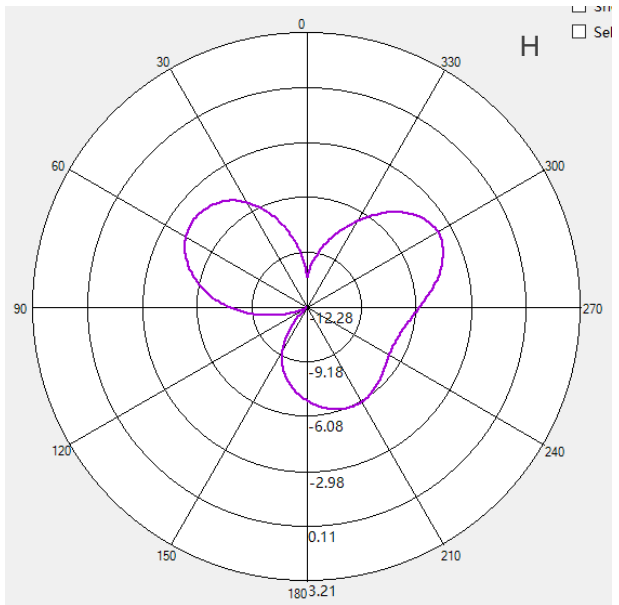
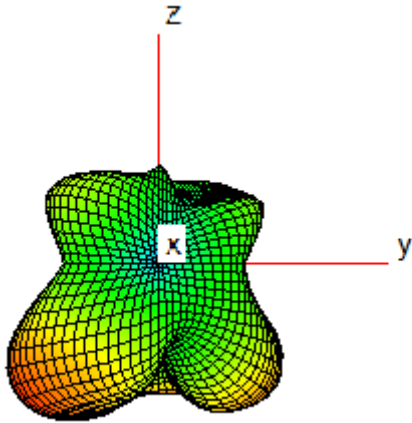

4.5.1.6. 2300 MHz

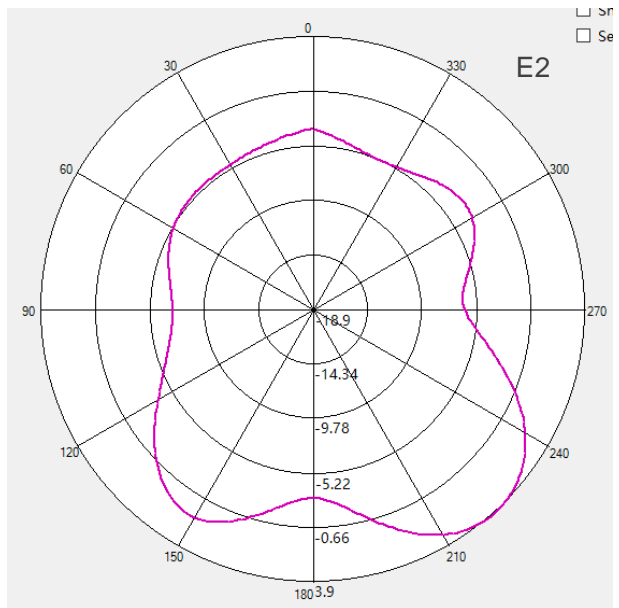
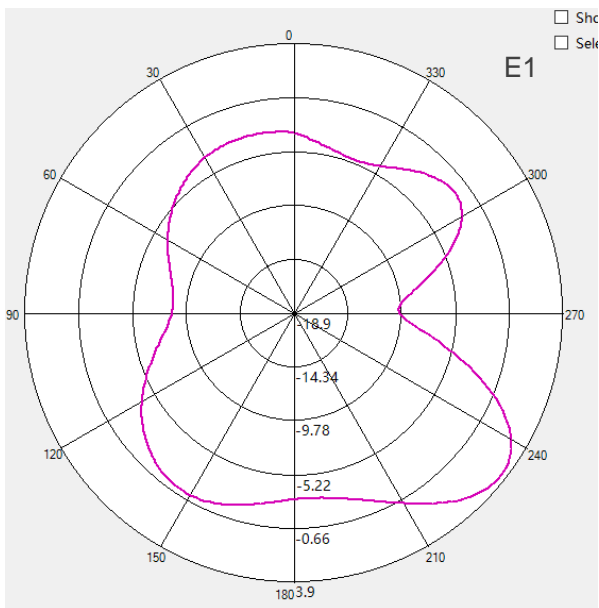
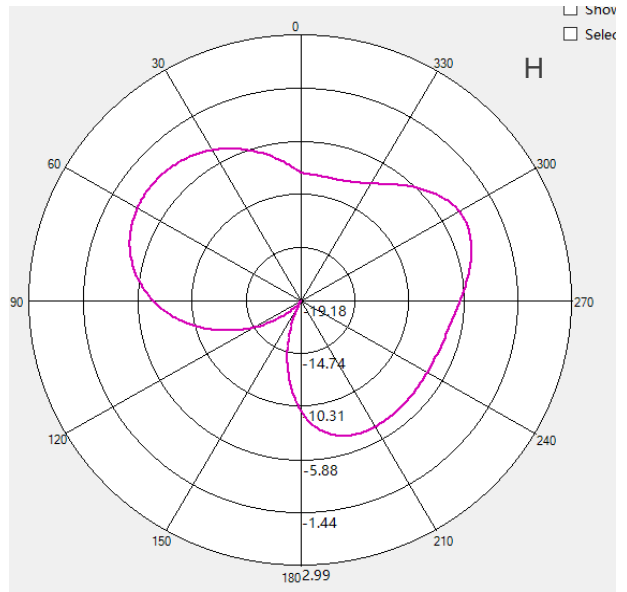
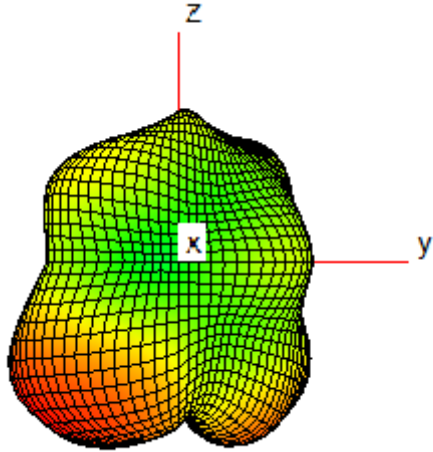

4.5.1.7. 2690 MHz

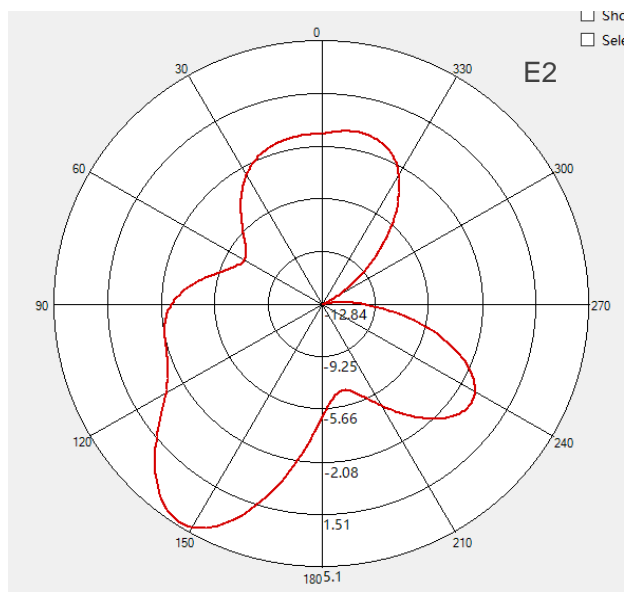
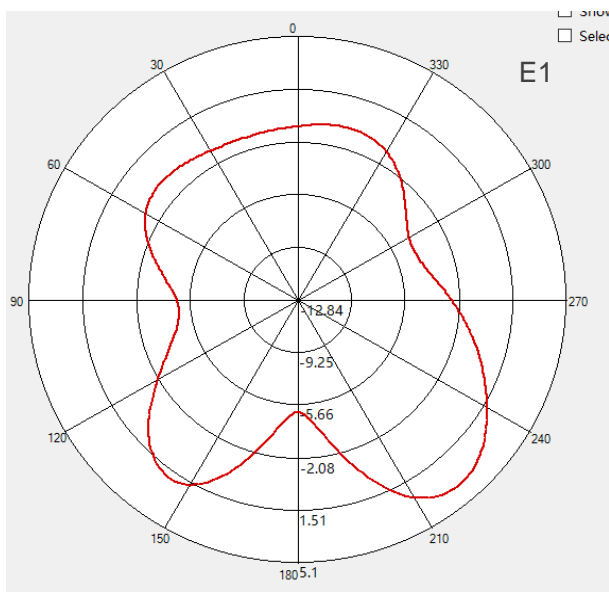
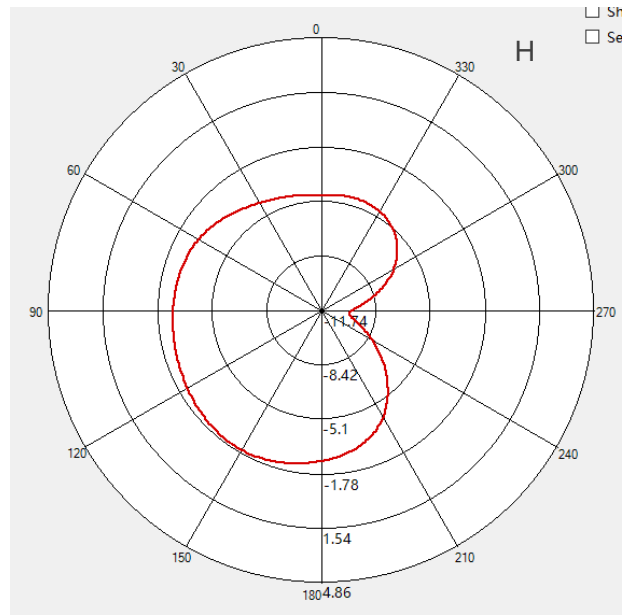
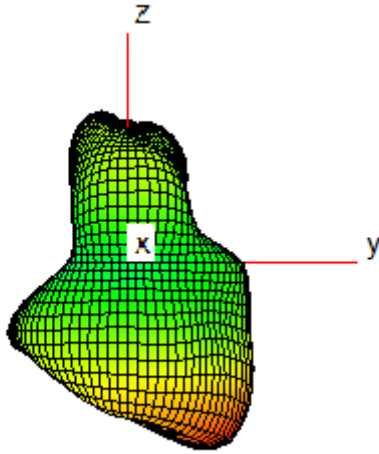

5 Schematic Symbol and Pin Definition

The pin assignment for the antenna is as follows. The antenna has 4 pins and only two work. All other pins are designed for mechanical strength.

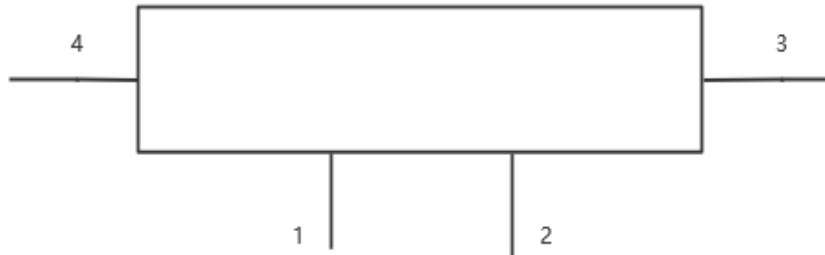

Pin No.	Description
1	Feed
2	Return/GND
3, 4	Not used (Mechanical only)

6 Transmission Line

The characteristic impedance of all transmission lines shall be designed as 50 Ω .

- The length of the transmission lines should be kept to as short as possible.
- Any other part of the RF system, such as transceiver, power amplifiers, etc., shall also be designed with an impedance of 50 Ω .

7 Recommend PCB Layout

- Test PCB Size: 135 mm × 40 mm
- PCB Clearance Area: 15 mm × 40 mm

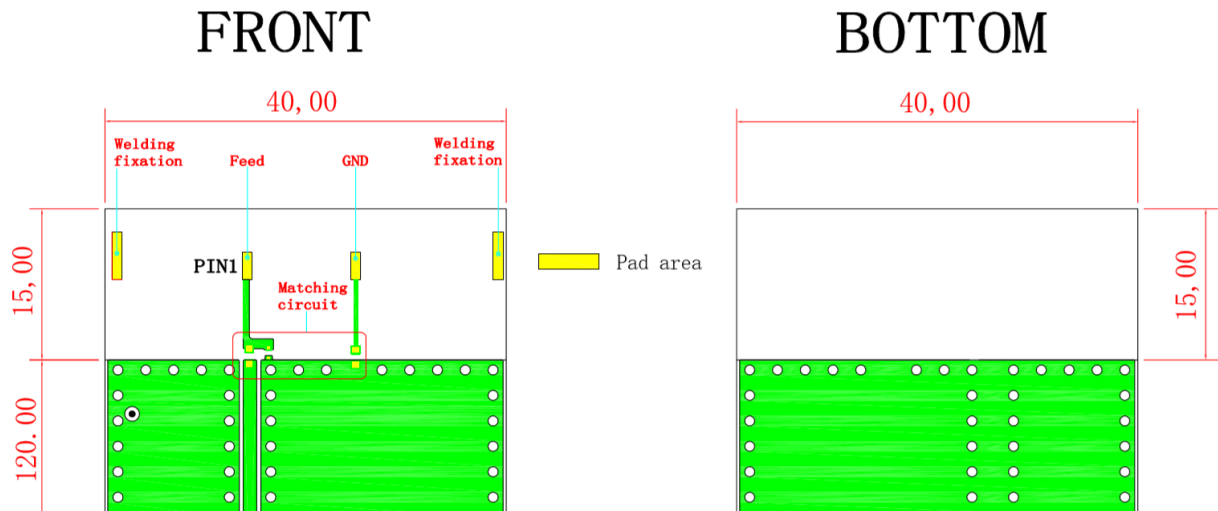

- Front Layout Details

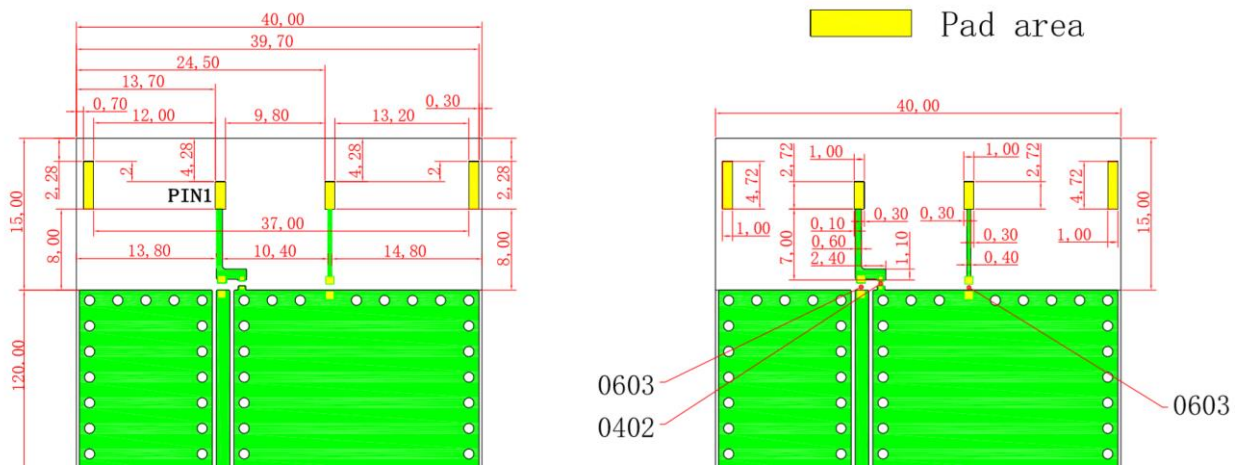

- Antenna Pad

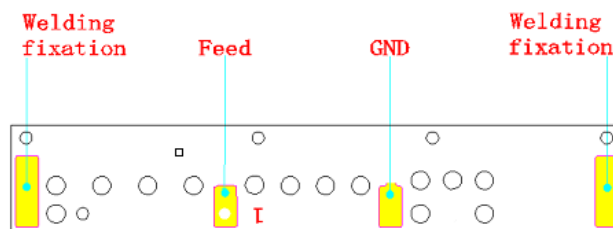

Front: Perspective view

8 Matching Circuit

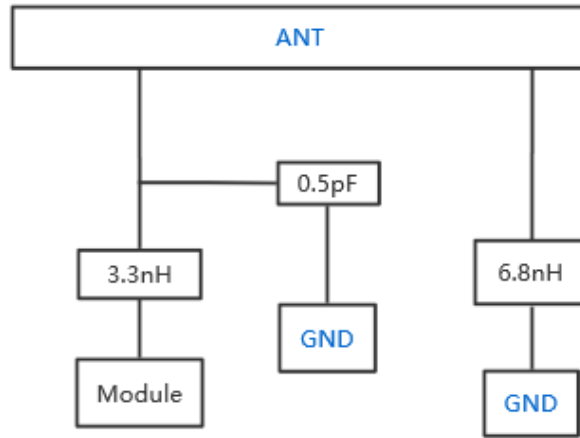

9 Soldering Temperature

Phase	Profile Features	PB-Free Assembly
RAMP-UP	Avg. Ramp-up Rate (T _{smax} to T _p)	3 °C/second (Max.)
PREHEAT	Temperature Min (T _{smin})	150 °C
	Temperature Max (T _{smax})	190 °C
	Time (t _{smin} to t _{smax})	110 seconds (Max.)
REFLOW	Temperature (T _L)	220 °C
	Total Time above T _L (t _l)	90 seconds (Max.)
PEAK	Temperature (T _p)	230–250 °C
RAMP-DOWN	Rate	-1 °C/second (Max.)

10 Reflow Profile

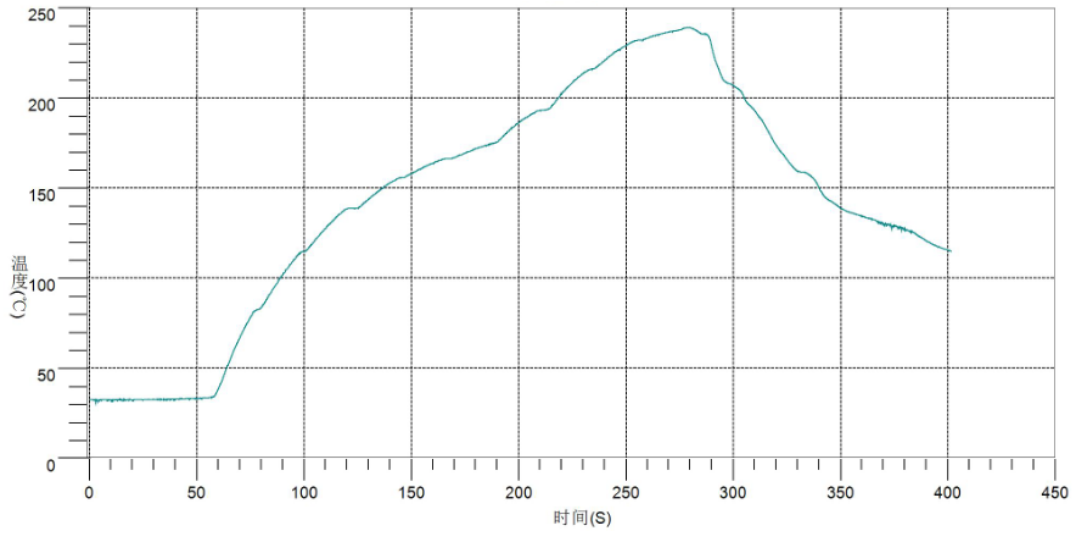

No	Probe name	150-190°C		>220°C	peak temperature°C
		60-110s	slope 0.0-3.0	40-90s	230-250°C
No.1	J1	67.9	0.59	52.4	239

furnace parameter	1	2	3	4	5	6	7	8	9	10	11	12
Up Temperature zone	175.0	185.0	185.0	185.0	190.0	195.0	230.0	275.0	275.0	275.0		
Down Temperature zone	175.0	185.0	185.0	185.0	190.0	195.0	230.0	275.0	275.0	275.0		
Temperature zone length	0	0	0	0	0	0	0	0	0	0	0	0

11 Package

- Quantity/Reel: 1500 pcs/Reel
- Carrier Tape Dimensions (mm)

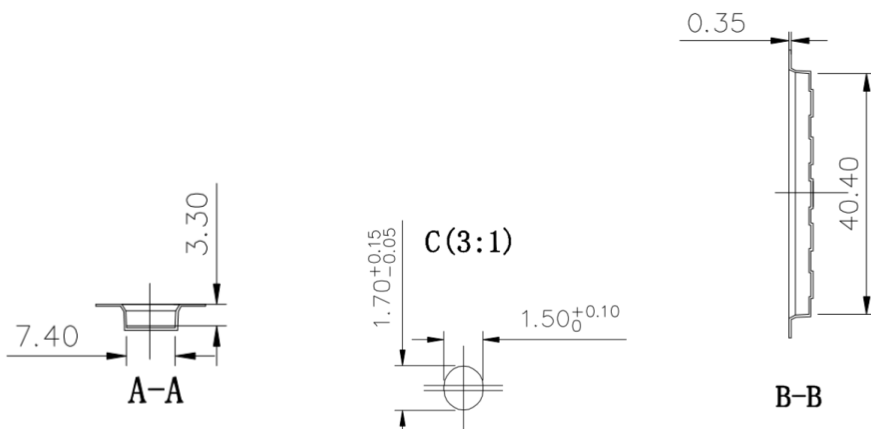
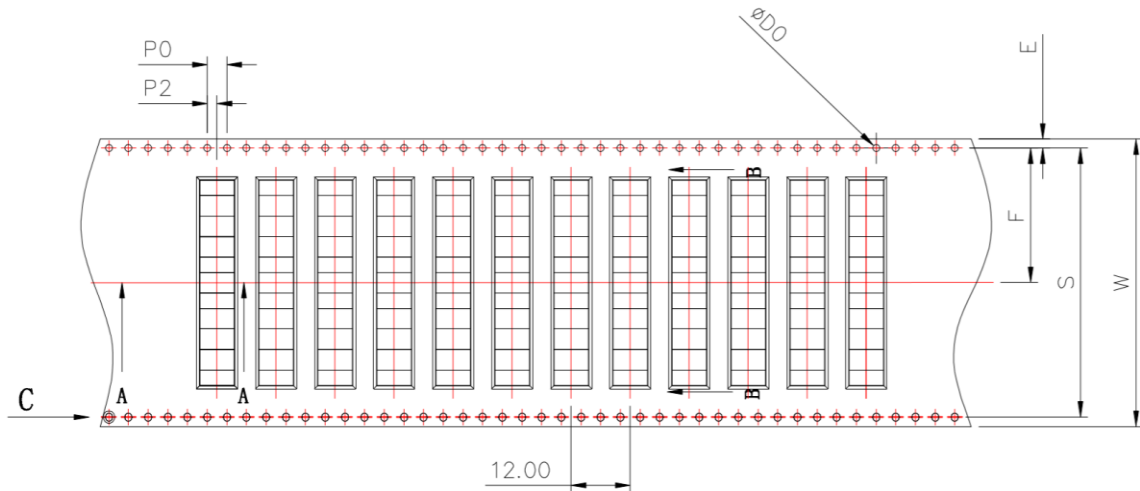

E	1.75±0.10
F	26.20±0.15
S	52.40±0.10
P2	2.00±0.10
$\phi D0$	1.50± $\begin{matrix} 0.10 \\ 0.00 \end{matrix}$
$\phi D1$	
P0	4.00±0.10
10P0	40.00±0.20
W	56.00±0.30

- Taping Reel Dimensions (mm)

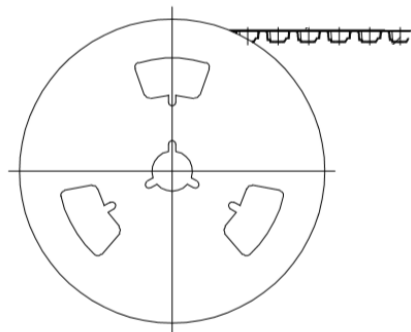

330 mm x 56 mm

12 Product Size (Unit: mm)

RoHS

