

Features

- 3.45mm x 3.45mm x 2.0mm SMD LED
- Zener diode provided for ESD Protection
- IR-reflow compatible
- High power UV LED
- White ceramic package with silicone resin
- Standard Package: 1,000pcs / Reel
- MSL (Moisture Sensitivity Level): 1
- Halogen-free
- RoHS compliant



ATTENTION
OBSERVE PRECAUTIONS
FOR HANDLING
ELECTROSTATIC
DISCHARGE
SENSITIVE
DEVICES

Package Schematics

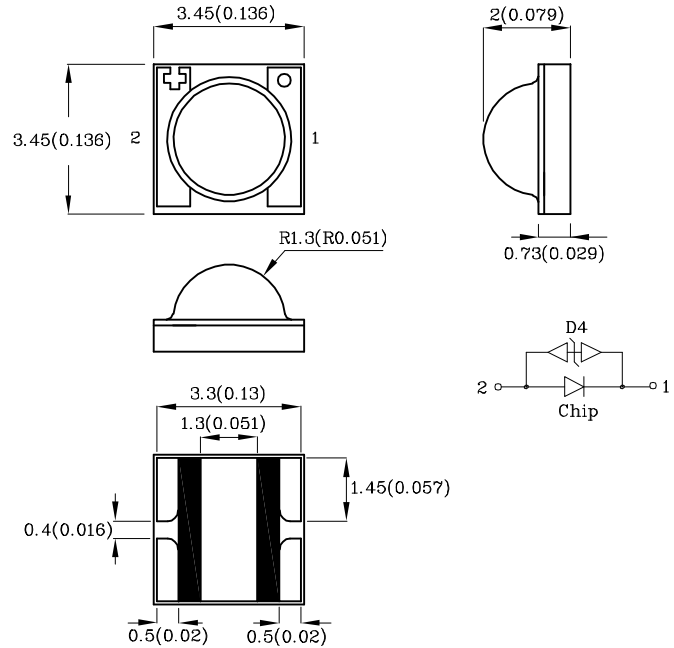

Notes:

1. All dimensions are in millimeters (inches).
2. Tolerance is $\pm 0.2(0.008)$ " unless otherwise noted.
3. Specifications are subject to change without notice.

Part Number	Emitting Color (Material)	Lens-color	Radiant Flux CIE127-2007* ($I_F=500\text{mA}$) $\Phi_e=\text{mW}$ [2]			Radiant Flux CIE127-2007* ($I_F=700\text{mA}$) $\Phi_e=\text{mW}$ [2]		Viewing Angle 20 1/2 [1]
			Code.	Min.	Max.	typ.	typ.	
XZVS160S-D	Ultraviolet (InGaN)	Water Clear	C14*	640*	740*			120°
			C15*	740*	850*	795*	1095*	
			C16*	850*	1000*			

Notes:

1. $\theta_{1/2}$ is the angle from optical centerline where the luminous intensity is 1/2 of the optical peak value.

2. Radiant flux: $\pm 15\%$.

*Radiant flux is in accordance with CIE127-2007 standards.

Absolute Maximum Ratings at $T_A=25^\circ\text{C}$

Parameter	Symbol	Value	Unit
DC Forward Current	I_F [1]	700	mA
Peak Forward Current	I_{FM} [2]	1000	mA
Reverse Voltage	V_R	5	V
Power dissipation	P_D	2.8	W
Operating Temperature	T_{op}	-40 To +100	$^\circ\text{C}$
Storage Temperature	T_{stg}	-40 To +115	$^\circ\text{C}$
Junction temperature	T_J [1]	115	$^\circ\text{C}$
Thermal resistance (Junction/ambient)	$R_{th\ j-a}$ [1]	10	$^\circ\text{C/W}$
Thermal resistance (Junction/solder point)	$R_{th\ j-s}$ [1]	5	$^\circ\text{C/W}$

Notes:

- Results from mounting on metal core PCB, mounted on pc board-metal core PCB is recommend for lowest thermal resistance.
- 1/10 Duty Cycle, 0.1ms Pulse Width.
- A Relative Humidity between 40% and 60% is recommended in ESD-protected work areas to reduce static build up during assembly process (Reference JEDEC/JESD625-A and JEDEC/J-STD-033)

Electrical / Optical Characteristics at $T_A=25^\circ\text{C}$

Parameter	Symbol	Value	Unit
Wavelength at peak emission $I_F = 500\text{mA}$ CIE127-2007* [Min.]	λ_{peak}	390*	nm
Wavelength at peak emission $I_F = 500\text{mA}$ CIE127-2007* [Typ.]		395*	
Wavelength at peak emission $I_F = 500\text{mA}$ CIE127-2007* [Max.]		400*	
Spectral bandwidth at 50% $\Phi_{REL\ MAX}$ $I_F = 500\text{mA}$ [Typ.]	$\Delta\lambda$	13	nm
Allowable Reverse Current [Max.]	I_R	85	mA
Forward Voltage $I_F = 500\text{mA}$ [Typ.]	V_F [1]	3.4	V
Forward Voltage $I_F = 500\text{mA}$ [Max.]		3.9	
Temperature coefficient of V_F $I_F = 500\text{mA}$, $-10^\circ\text{C} \leq T \leq 100^\circ\text{C}$ [Typ.]	TC_V	-3.0	$\text{mV}/^\circ\text{C}$

Notes:

- Forward Voltage : + / - 0.1V.

* wavelength is in accordance with CIE127-2007 standards.

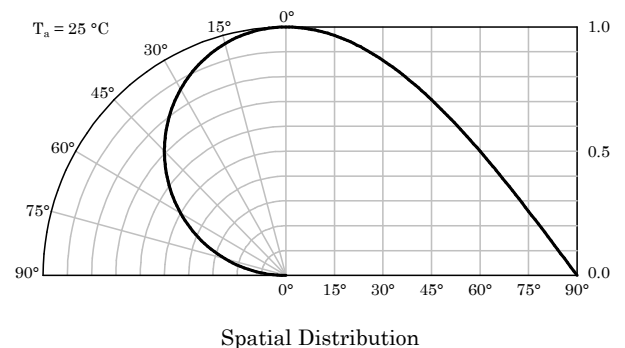
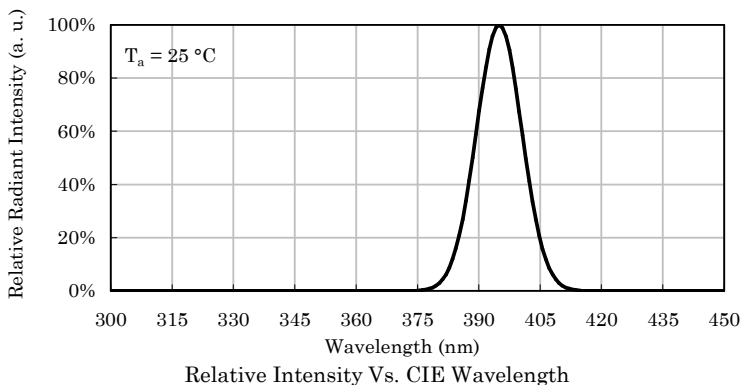

❖ Ultraviolet

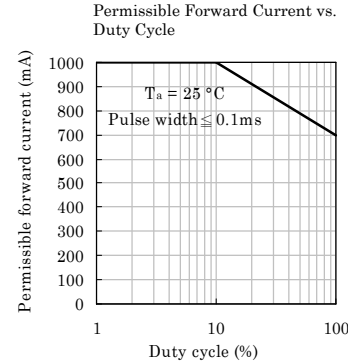
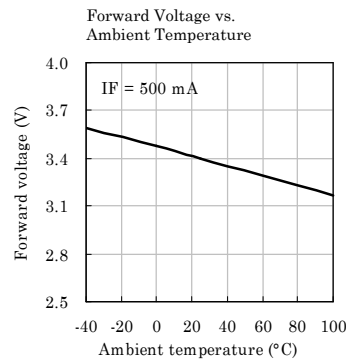
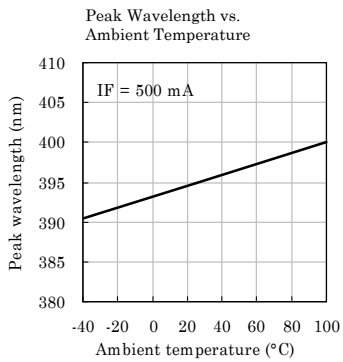
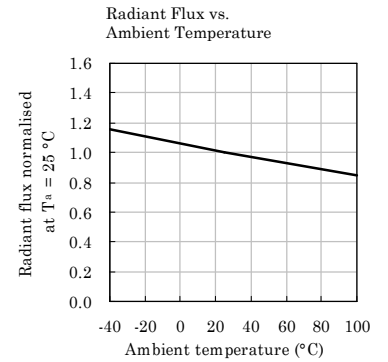
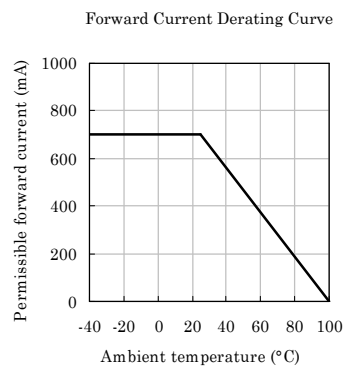
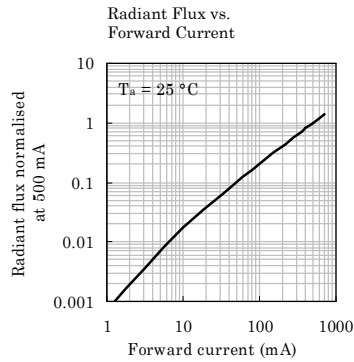
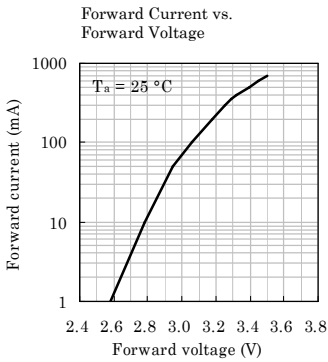

Heat Generation:

1. Thermal design of the end product is of paramount importance. Please consider the heat generation of the LED when making the system design. The coefficient of temperature increase per input electric power is affected by the thermal resistance of the circuit board and density of LED placement on the board, as well as other components. It is necessary to avoid intense heat generation and operate within the maximum ratings given in this specification.
2. Please determine the operating current with consideration of the ambient temperature local to the LED and refer to the plot of Permissible Forward current vs. Ambient temperature on Characteristics in this specification. Please Also take measures to remove heat from the area near the LED to improve the operational characteristics on the LED.
3. The equation ① indicates correlation between T_j and T_a , and the equation ② indicates correlation between T_j and T_s

$$T_j = T_a + R_{thj-a} * W \dots\dots\dots \textcircled{1}$$

$$T_j = T_s + R_{thj-s} * W \dots\dots\dots \textcircled{2}$$

T_j = dice junction temperature: °C

T_a = ambient temperature: °C

T_s = solder point temperature: °C

R_{thj-a} = heat resistance from dice junction temperature to ambient temperature : °C/ W

R_{thj-s} = heat resistance from dice junction temperature to T_s measuring point : °C/ W

W = inputting power ($I_F \times V_F$) : W

❖ Reflow soldering is recommended and the soldering profile is shown below.
Other soldering methods are not recommended as they might cause damage to the product.

Reflow Soldering Profile for SMD Products (Pb-Free Components)

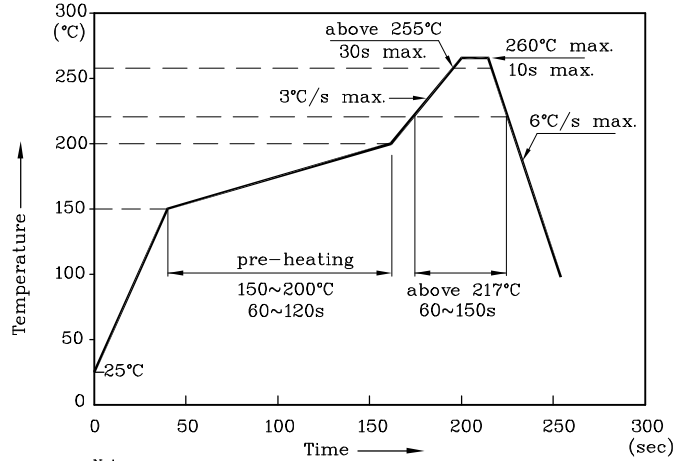

Notes:

1. All temperatures refer to the center of the package, measured on the package body surface facing up during reflow.
2. Do not apply any stress to the LED during high temperature conditions.
3. Maximum number of soldering passes: 2

❖ Recommended Soldering Pattern (Units : mm; Tolerance: ±0.1)

❖ The device has a single mounting surface. The device must be mounted according to the specifications.

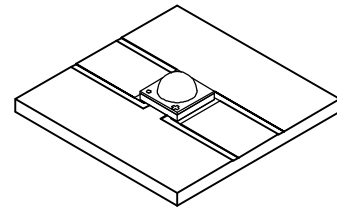
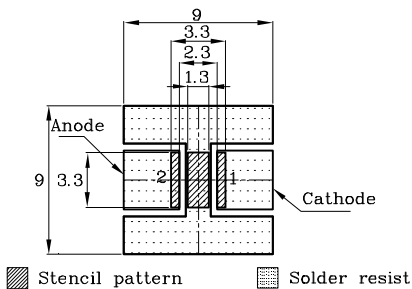

❖ Tape Specification (Units : mm)

❖ Reel Dimension (Units : mm)

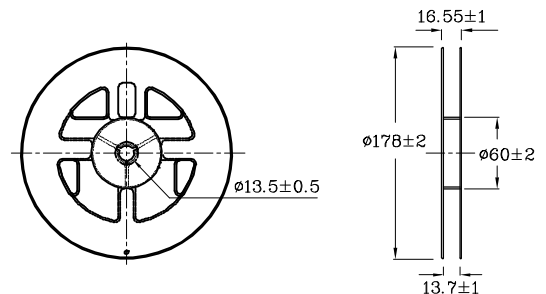
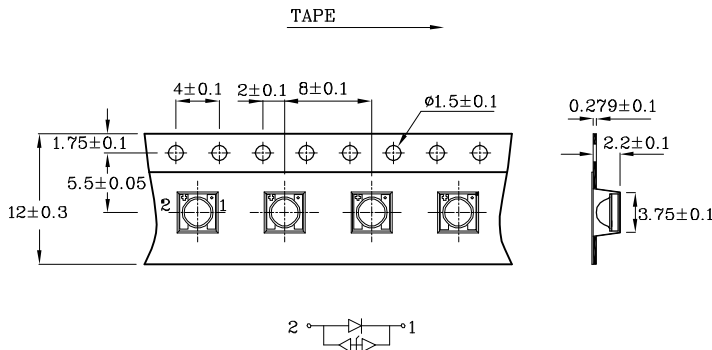



PACKING & LABEL SPECIFICATIONS

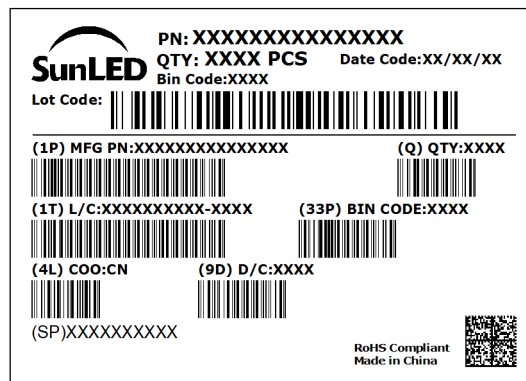
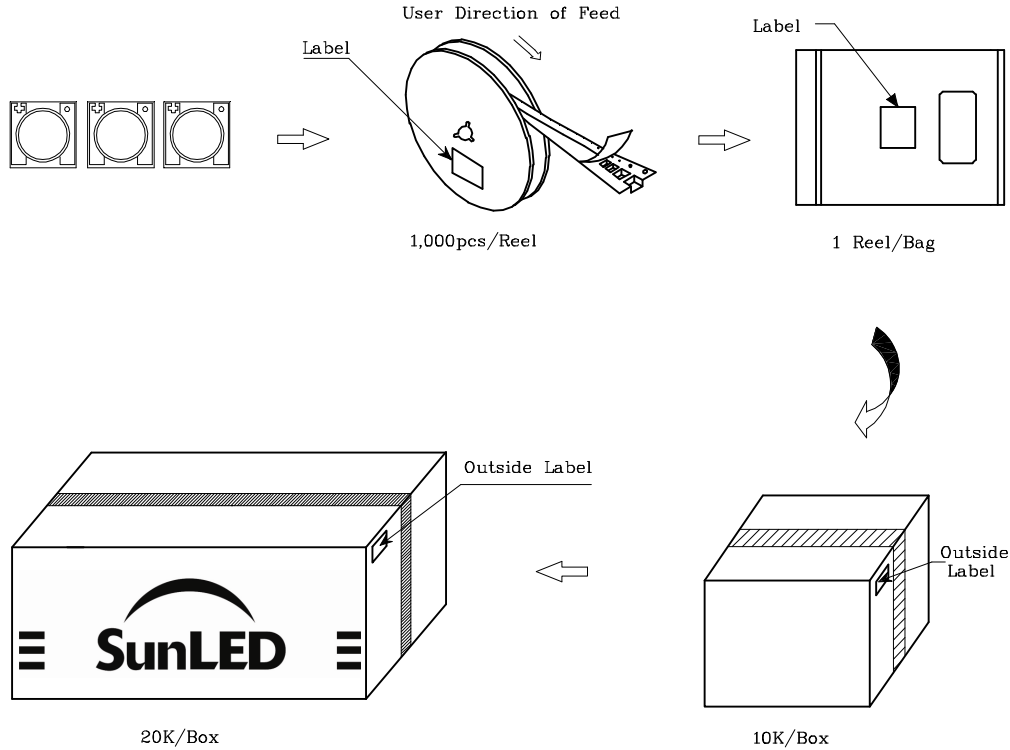

TERMS OF USE

1. Data presented in this document reflect statistical figures and should be treated as technical reference only.
2. Contents within this document are subject to improvement and enhancement changes without notice.
3. The product(s) in this document are designed to be operated within the electrical and environmental specifications indicated on the datasheet. User accepts full risk and responsibility when operating the product(s) beyond their intended specifications.
4. The product(s) described in this document are intended for electronic applications in which a person's life is not reliant upon the LED. Please consult with a SunLED representative for special applications where the LED may have a direct impact on a person's life.
5. The contents within this document may not be altered without prior consent by SunLED.
6. Additional technical notes are available at <https://www.SunLEDusa.com/TechnicalNotes.asp>

Handling Precautions

Compare to epoxy encapsulant that is hard and brittle, silicone is softer and flexible. Although its characteristic significantly reduces thermal stress, it is more susceptible to damage by external mechanical force.

As a result, special handling precautions need to be observed during assembly using silicone encapsulated LED products. Failure to comply might lead to damage and premature failure of the LED.

1. Handle the component along the side surfaces by using forceps or appropriate tools.

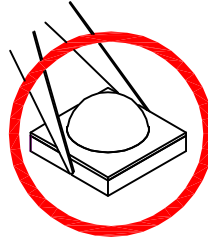

2. Do not directly touch or handle the silicone lens surface. It may damage the internal circuitry.

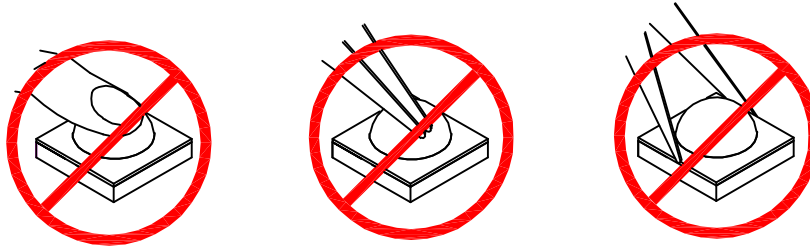

3. Do not stack together assembled PCBs containing exposed LEDs. Impact may scratch the silicone lens or damage the internal circuitry.



- 4.1. There should be enough space inside the nozzle to avoid contact with the dome lens during pick up.
- 4.2. The inner diameter of the SMD pickup nozzle should not exceed the size of the LED to prevent air leaks.
- 4.3. A pliable material is suggested for the nozzle tip to avoid scratching or damaging the LED surface during pickup.
- 4.4. The dimensions of the component must be accurately programmed in the pick-and-place machine to insure precise pickup and avoid damage during production.

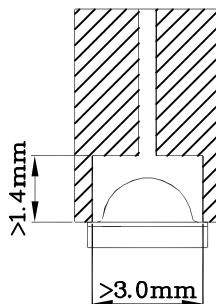

5. As silicone encapsulation is permeable to gases, some corrosive substances such as H_2S might corrode silver plating of leadframe. Special care should be taken if an LED with silicone encapsulation is to be used near such substances.

Designing the Position of LED on a Board.

- No twist/warp/bent/or other stress shall be applied to the board after mounting LED with solder to avoid a crack of LED package.

Refer to the following recommended position and direction of LED.

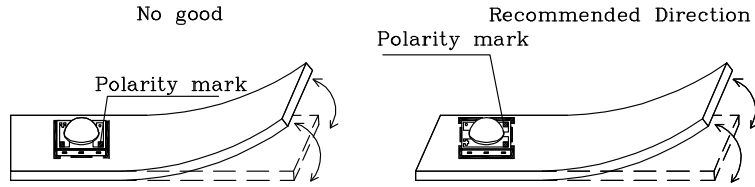

Appropriate LED mounting is to place perpendicularly against the stress affected side.

- Depending on the position and direction of LED, the mechanical stress on the LED package can be changed.

Refer to the following figure.

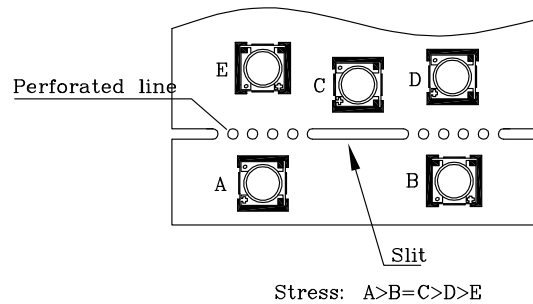

- Do not split board by hand. Split with exclusive special tool.
- If an aluminum circuit board is used, a large stress by thermal shock might cause a solder crack.

For this reason, it is recommended an appropriate verification should be taken before use.

JEDEC Moisture Sensitivity:

Level	Floor Life		Soak Requirements			
			Standard		Accelerated Equivalent	
	Time	Conditions	Time (hours)	Conditions	Time (hours)	Conditions
1	Unlimited	≤ 30 °C / 85% RH	168 + 5 / - 0	85 °C / 85% RH		

SunLED recommends keeping the LEDs in the sealed moisture-barrier packaging until immediately prior to use. Any unused LEDs should be returned to the moisture-barrier bag and closed immediately after use.

ESD Protection During Production

Electric static discharge can result when static-sensitive products come in contact with the operator or other conductors.

The following procedures may decrease the possibility of ESD damage:

- Minimize friction between the product and surroundings to avoid static buildup.
- All production machinery and test instruments must be electrically grounded.
- Operators must wear anti-static bracelets.
- Wear anti-static suit when entering work areas with conductive machinery.
- Set up ESD protection areas using grounded metal plating for component handling.
- All workstations that handle IC and ESD-sensitive components must maintain an electrostatic potential of 150V or less.
- Maintain a humidity level of 50% or higher in production areas.
- Use anti-static packaging for transport and storage.
- All anti-static equipment and procedures should be periodically inspected and evaluated for proper functionality.

Reliability Test Items And Conditions

The reliability of products shall be satisfied with items listed below

Lot Tolerance Percent Defective (LTPD) : 10%

No.	Test Item	Standards	Test Condition	Test Times / Cycles	Number of Damaged
1	Continuous operating test	-	Ta =25°C +10/-5°C ,RH=55+/-20%RH IF = maximum rated current*	1,000 h	0 / 22
2	High Temp. operating test	-	Ta = 100°C(+/-10°C) IF = maximum rated current*	1,000 h	0 / 22
3	Low Temp. operating test	-	Ta = -40°C+3/-5°C IF = maximum rated current*	1,000 h	0 / 22
4	High temp. storage test	JEITA ED-4701/200 201	Ta = 100°C(+/-10°C) Ta = maximum rated storage temperature	1,000 h	0 / 22
5	Low temp. storage test	JEITA ED-4701/200 202	Ta = -40°C+3/-5°C	1,000 h	0 / 22
6	High temp. & humidity storage test	JEITA ED-4701/100 103	Ta = 60°C+5/-3°C, RH = 90+5/-10%RH	1,000 h	0 / 22
7	High temp. & humidity operating test	-	Ta = 60°C+5/-3°C, RH = 90+5/-10%RH IF = maximum rated current*	1,000h	0 / 22
8	Resistance to Soldering Heat (Reflow Soldering)	JEITA ED-4701/300 301	Tsld=260°C,10sec	2 times	0 / 22
9	Solderability (Reflow Soldering)	JEITA ED-4701/303 303A	Tsld=245°C+/-5°C,5+/-1sec	1 time over 95%	0 / 22
10	Temperature Cycle operating test	-	-40°C(30min) ~25°C(5min)~100°C (30min) ~25°C(5min) IF = derated current at 100°C	10cycles	0 / 22
11	Temperature Cycle	JEITA ED-4701/100 105	-40°C(30min) ~25°C(5min)~100°C (30min) ~25°C(5min)	100cycles	0 / 22
12	Thermal shock test	MIL-STD-202G	Ta = -40°C(15min) ~100°C(15min)	500 cycles	0 / 22
13	Electric Static Discharge (ESD)	JEITA ED-4701/300 304	C = 100pF , R= 1.5KΩ V = 8000 V	3 times Negative/Positive	0 / 22
14	Vibration test	JEITA ED-4701/400 403	100~2000~100HZ Sweep 4min. 200m/s ² 3directions,4cycles	48min.	0 / 22

Note : Refer to forward current vs. derating curve diagram.

Criteria For Judging Damage

Item	Symbol	Test Conditions	Criteria for Judgement	
			Min.	Max.
Forward Voltage	V _F	IF = 500mA	-	Initial Level x 1.1
Radiant Flux	Φ _e	IF = 500mA	Initial Level x 0.7	-

Note: The test is performed after the board is cooled down to the room temperature.