

XP series

Mid-size flexible proportional joystick •
non-contacting Hall effect technology



DISTINCTIVE FEATURES

- One or two axis
- Dual and dual inverse analogue and PWM outputs
- CAN J1939 & CANOpen
- All metal mechanism construction



ENVIRONMENTAL SPECIFICATIONS

- Operating Temperature: -30 °C to +70 °C (-22 °F to 158 °F)
- Storage Temperature: -40 °C to +85 °C (-40 °F to 185 °F)
- Sealing: IP66 (above panel subject to handle and final specification)
- EMC Immunity Level: EN61000-4-3 (exceeds)
- EMC Emissions Level: EN61000-6-3:2001, CPSPR 32:2015, Class B 30 MHz-1GHz
- ESD: EN61000-4-2 (exceeds)



ELECTRICAL SPECIFICATIONS

- Analog output Voltage Range: $\pm 10\% \times V$ to $\pm 50\% \times V$
- Output at Center: $V/2 \pm (5\% \times \text{gain})$
- Power Supply: 5 V ± 0.5 V transient free; 3.3 V ± 0.1 V
- Output impedance: 10 Ω
- Overvoltage max: +20 V



MECHANICAL SPECIFICATIONS

- Break out force: 3-5 N (subject to handle)
- Operating force: up to 12 N (subject to handle)
- Maximum force: Subject to handle
- Maximum Vertical Load: 1000 N (225 lbf) (subject to handle)
- Mechanical Angle of Movement: $\pm 17.5^\circ$ X & Y axis (subject to limiter)
- Expected Mechanical Life: 10 million lifecycles
- Mass/weight: 500 g (17.64 oz) nominal

The company reserves the right to change specifications without notice.



XP series

Mid-size flexible proportional joystick • non-contacting Hall effect technology



CONNECTIONS

The analogue and PWM joysticks are fitted as standard with 180mm(+/- 20mm) harnesses. Terminated to a 26 way housing TE 1-1827863-3.

Non standard connectors can be fitted upon request.

EXAMPLE WIRING TABLE		
TE CONNECTIVITY 1-1827863-3 PINOUT		
PIN	COLOUR	FUNCTION
A1	RED	+VA
B1	BLACK	0VA
A2	RED	+VB
B2	BLACK	0VB
A3	BLUE	X Axis A
B3	YELLOW	Y Axis A
A4	BROWN	X Axis B
B4	WHITE	Y Axis B
A5	GREEN	Z Axis A
B5	ORANGE	Z Axis B
A6	GREEN	Centre Tap
B6	ORANGE	Centre Detect
A7	ORANGE	Switch Common
B7	BLUE	Front Switch
A8	RED	Enable Switch Common
B8	RED	Enable Switch Normally Open
A9	RED	Enable Switch Normally Closed
B9	GREEN	Handle Function 1
A10	BLUE	Handle Function 2
B10	ORANGE	Handle Function 3
A11	GREEN	Handle Function 4
B11	BLUE	Handle Function 5
A12		
B12		
A13		
B13		

CONNECTOR DETAIL

26 way housing TE 1-1827863-3

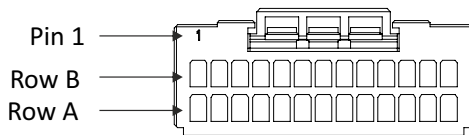

WIRE SIDE



MATERIALS

- Shaft: Stainless steel
- Boot: Neoprene
- Body: Zinc
- Handles:
AR & AQ - Anodised aluminium
- UR: Reinforced Nylon
- MF: Reinforced Nylon



TERMINATION (CAN OUTPUTS ONLY)

- The XP series CAN options are supplied with 200mm harness terminated with an industrial connector.
- Corrector detail: DTM04-6P (Fig 1)

Fig. 1

Deutsch DTM04-6P

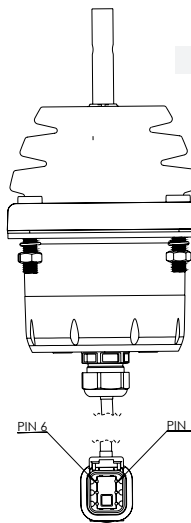

PIN	Connection	Colour
1	CAN LO	White
2	CAN HI	Green
3	ID LSB	Blue
4	ID MSB	Yellow
5	0V	Black
6	+12V	Red

Mid-size flexible proportional joystick • non-contacting Hall effect technology



MOUNTING

When mounting the joystick, consideration should be given to the position so that unnecessary risk of damage is minimised. If the joystick is intended for use in a mobile enclosure then care must be taken to protect the joystick from damage caused by dropping. Basic precautions such as mounting it at the lightest end of the enclosure so it doesn't hit the ground first or by protecting it with a guard should always be implemented for long term reliability.

DROP-IN MOUNT CUT-OUT AND INSTALLATION BEZEL OPTION 6

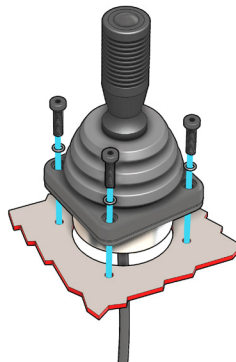
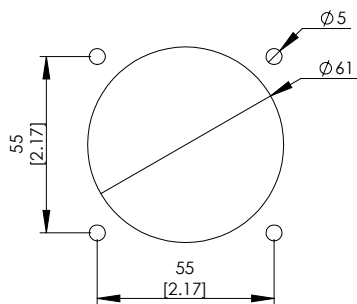

- The joystick is dropped into the panel cut-out.
- Supplied with M5 low profile cap head bolts, spring washers and nuts. Must be torqued to 0.7 Nm
- When mounted this way the gaiter forms part of the panel seal however an addition seal is provided to ensure good bezel to panel contact.

UNDER PANEL MOUNT CUT-OUT AND INSTALLATION BEZEL OPTION 0

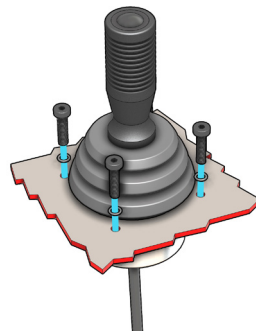
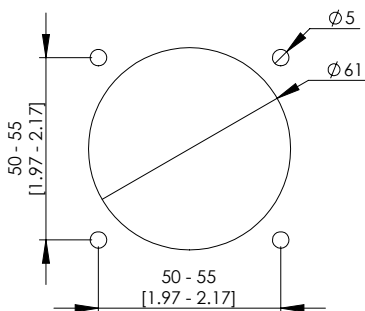

- When mounted this way the panel acts as the bezel and no separate bezel is needed.
- Supplied with sealed M5 screws spring washers and nuts. Must be torqued to 0.7 Nm
- When mounted this the upper part of the gaiter forms part of the panel seal, however an addition seal is provided to ensure good bezel to panel contact.

NOTES:

1. Dimensions are in mm/(inch).
2. The dimensions shown are for XP AR handle. For specific dimensions of this or any other configuration please refer to APEM.
3. When sub panel mounting, great care should be taken not to damage the boot, or any of the mechanism under the boot.

All panel cut-outs should be free from sharp edges and debris that may damage the boot.

XP series

Mid-size flexible proportional joystick • non-contacting Hall effect technology



BUILD YOUR PART NUMBER

JOYSTICK BASE

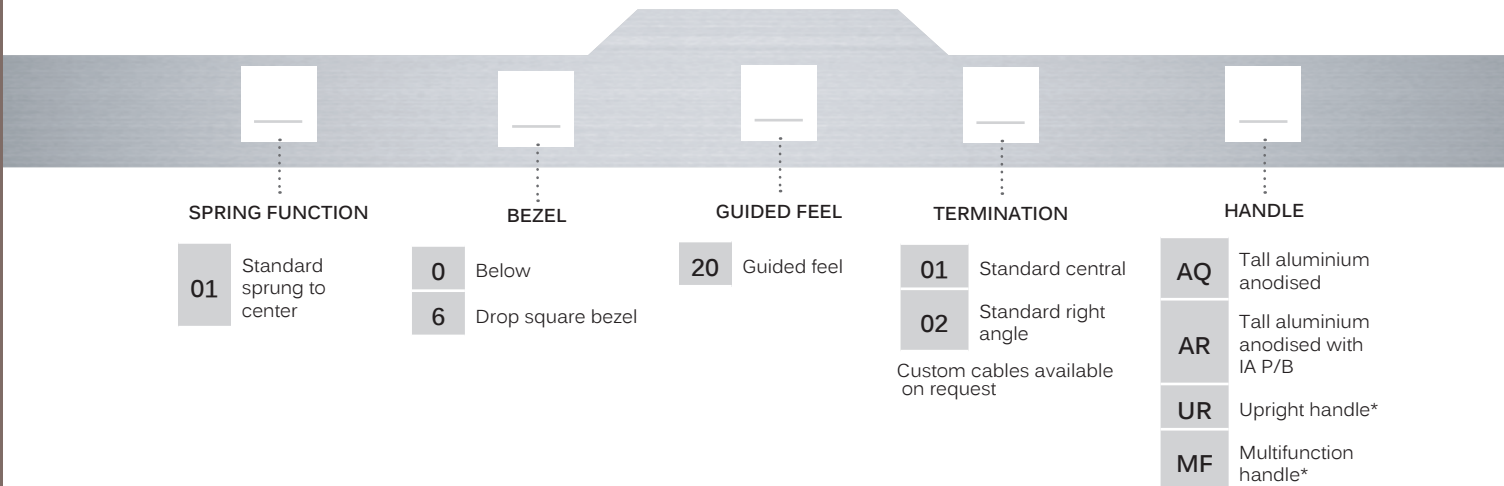
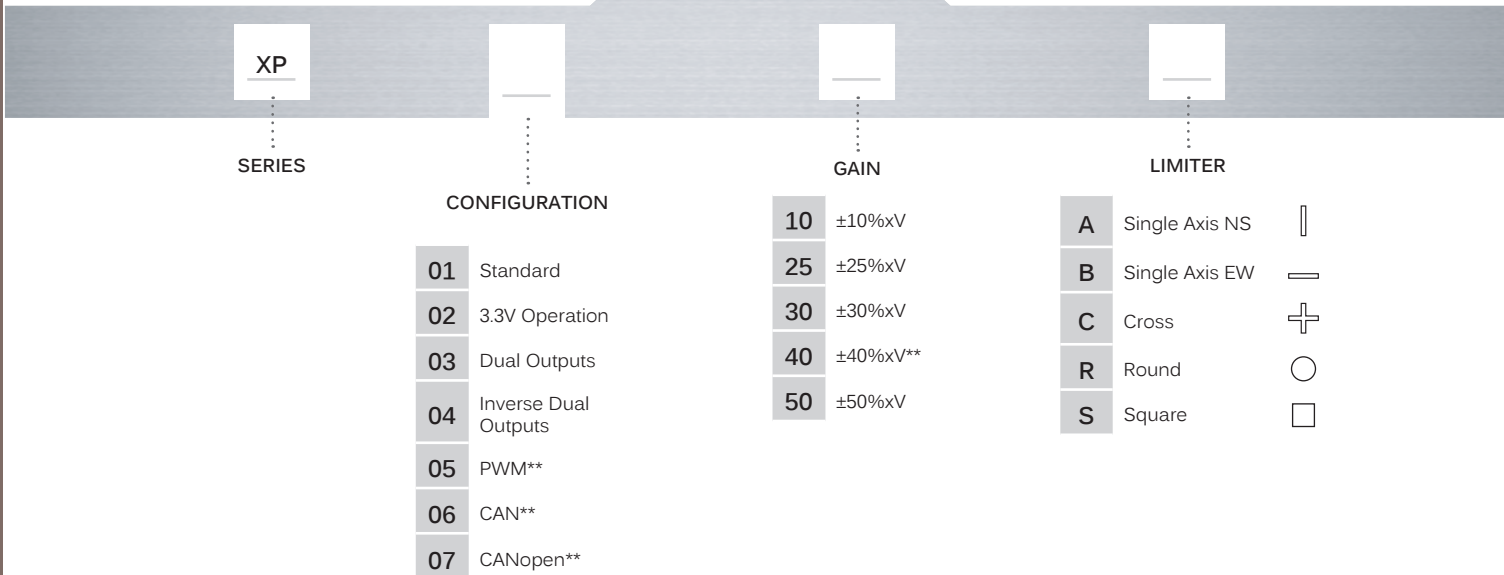

NOTES:

* Part number continue on next page

** For output options 05, 06 and 07 40% gain is the default

Mid-size flexible proportional joystick • non-contacting Hall effect technology

BUILD YOUR PART NUMBER (continued)

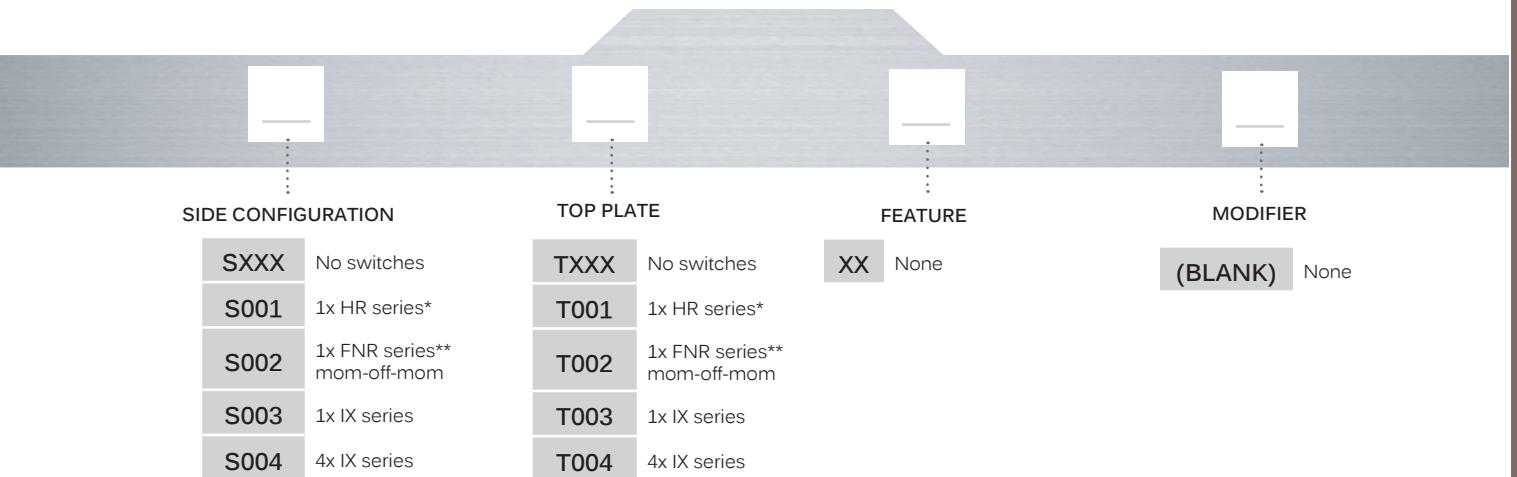
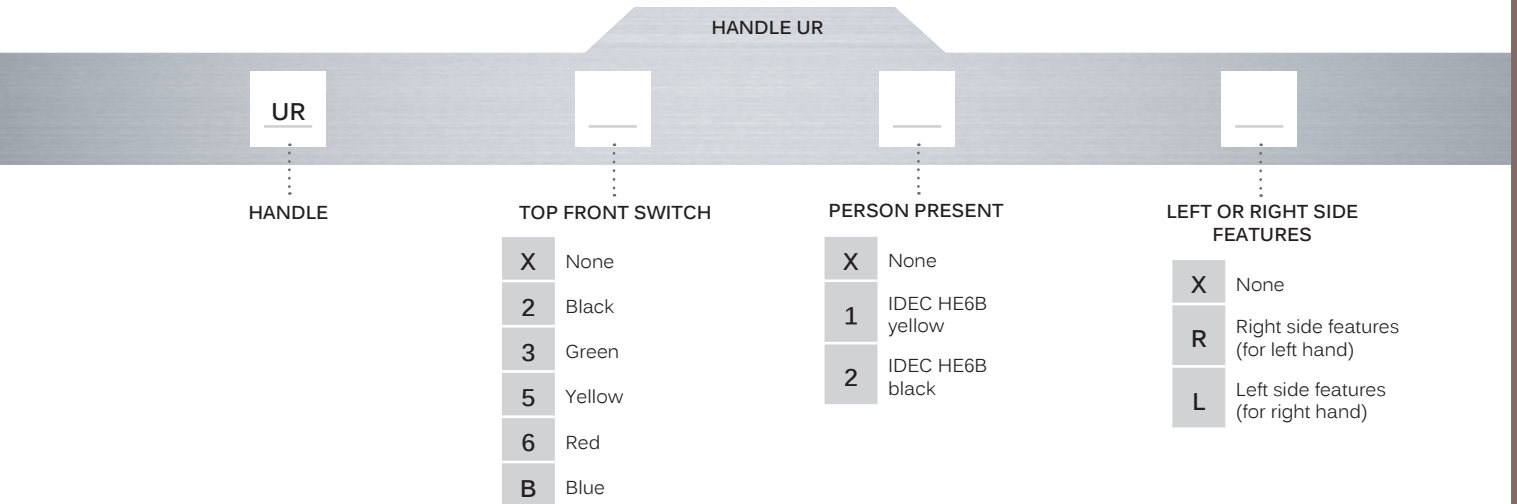

NOTES:

* Standard option is a black HR series, single tab, 40% gain, single output. Many other options available (see APEM HR datasheet)

** Standard option is a black FNR series, no marking, MOM-OFF-MOM. Many other options available (see APEM FNR datasheet)

XP series

Mid-size flexible proportional joystick • non-contacting Hall effect technology

WITH HANDLE OPTION AR

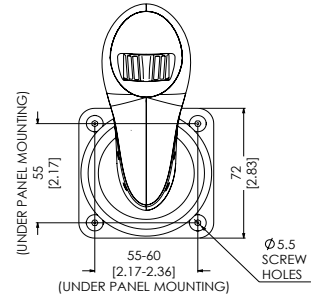
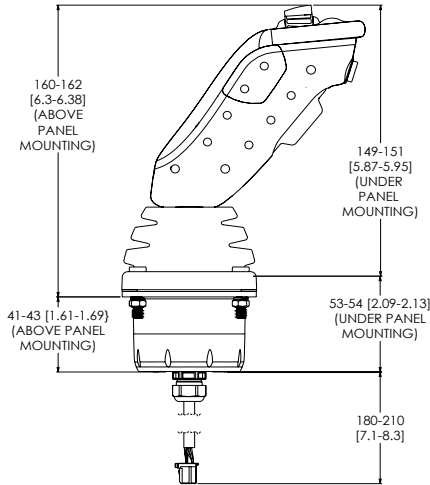

WITH CAN CONFIGURATION

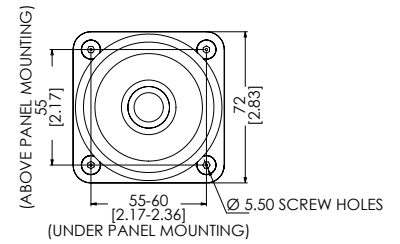
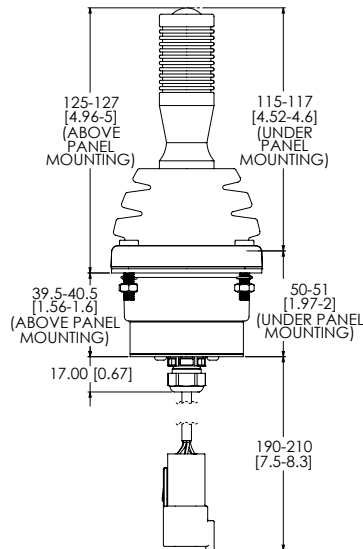

XP series

Mid-size flexible proportional joystick • non-contacting Hall effect technology



HANDLE OPTIONS

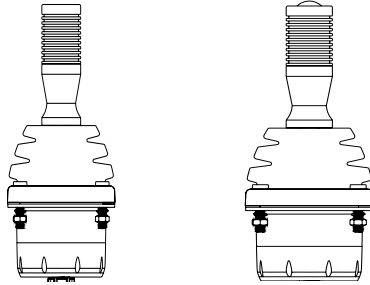

HANDLE	AQ	AR
MATERIAL	Aluminium	Aluminium
FINISH	Anodized	Anodized
STANDARD COLOR	Black	Black
NOTES		Uses APEM IA switch
SEALING	IP66	IP66
MAX HORIZONTAL LOAD	TBC	TBC
MAX Z LOAD	3Nm	3Nm

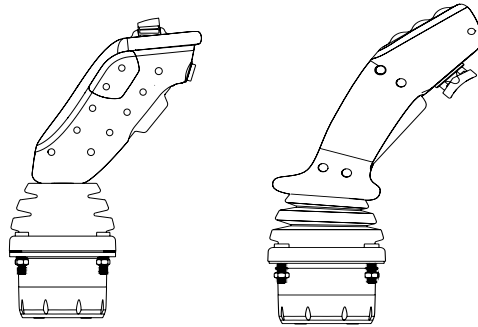

HANDLE	UR	MF
MATERIAL	Reinforced nylon	Reinforced nylon
FINISH	Anodized	Texture
STANDARD COLOR	Black	Black
SEALING	IP67	IP66
MAX HORIZONTAL LOAD	TBC	TBC
MAX Z LOAD	5Nm	5Nm

TOP FRONT SWITCH

BASIC P/N

X None

- 2 Black
- 3 Green
- 5 Yellow
- 6 Red
- B Blue

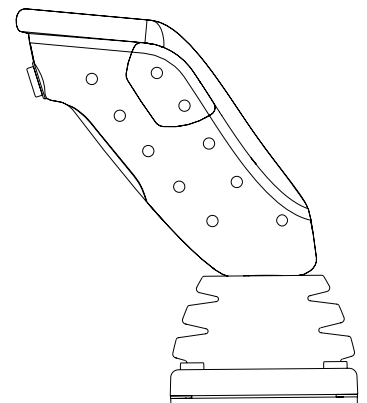
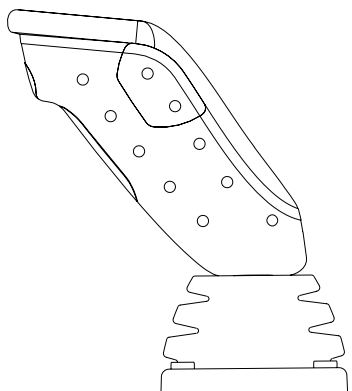

XP series

Mid-size flexible proportional joystick • non-contacting Hall effect technology

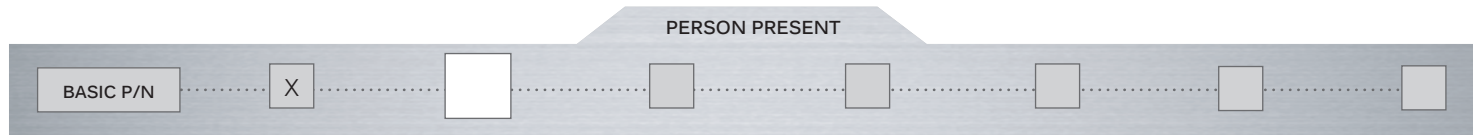

X None

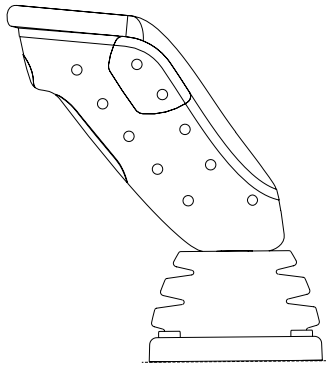

- 1 IDEC HE6B yellow
- 2 IDEC HE6B black

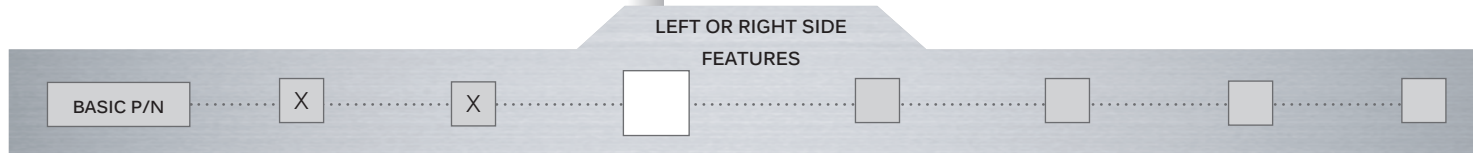
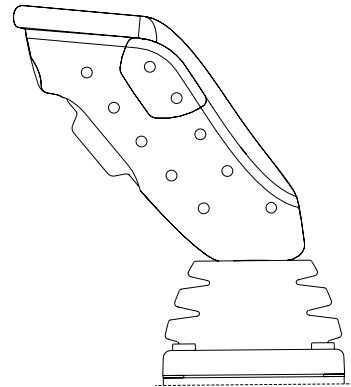

X None

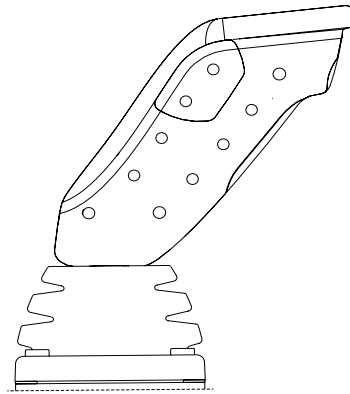
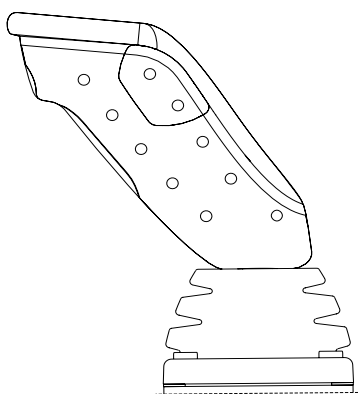

XP series

Mid-size flexible proportional joystick • non-contacting Hall effect technology

R Right side features for left hand

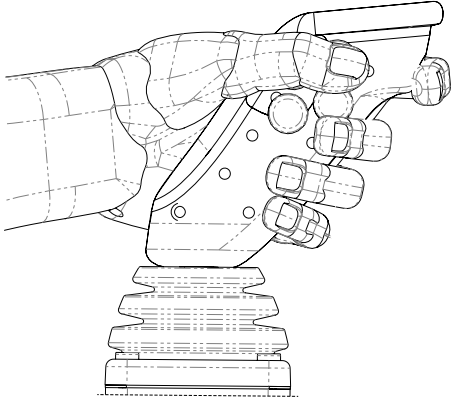

L Left side features for right hand

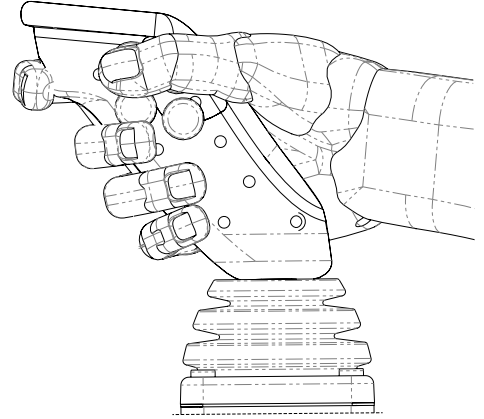

SIDE CONFIGURATION



XX No switches

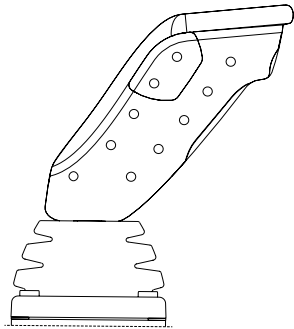

01 HR series

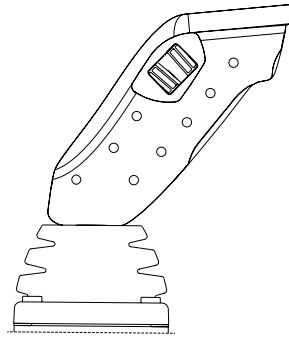

02 FNR series mom-off-mom

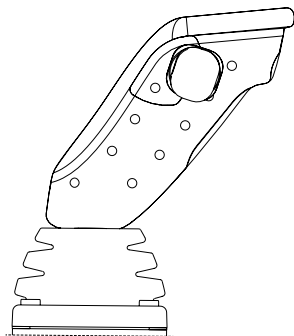

03 IX series

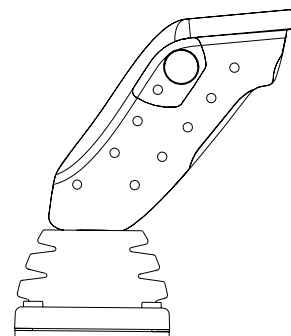

XP series

Mid-size flexible proportional joystick • non-contacting Hall effect technology

04 4x IX series

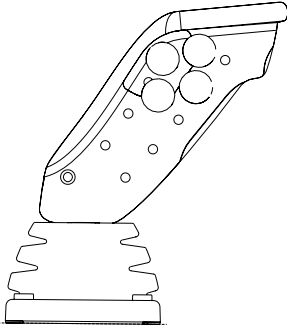

TOP PLATE



XX No switches

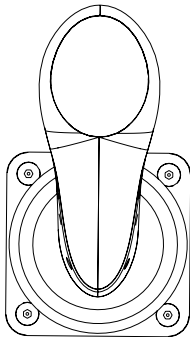

01 HR series

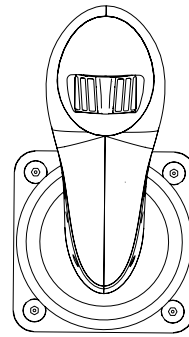

02 FNR series mom-off-mom

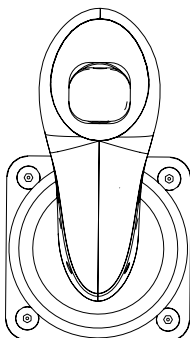

03 IX series

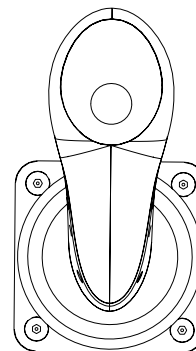

XP series

Mid-size flexible proportional joystick •
non-contacting Hall effect technology

04 4 x IX series

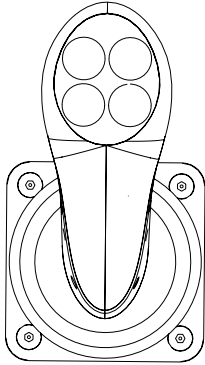

Custom options available please contact APEM for further details.

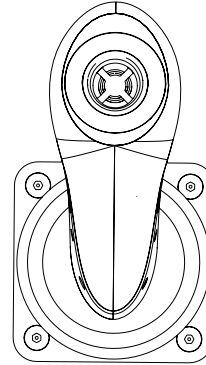

XP series

Mid-size flexible proportional joystick • non-contacting Hall effect technology



BUILD YOUR PART NUMBER (continued)

HANNDLE MF



HANDLE

PERSON PRESENT

FACEPLATE TRIM

FACEPLATE

X	No trigger
2	Black trigger

N1	Blue RAL 5012
N2	Black RAL 9011
N3	Green RAL 6016
N4	Grey RAL 7044
N5	Yellow RAL 1023
N6	Red RAL 3031
N7	White RAL 1014
N9	Orange RAL 2009

FXXX	No switches
F001	1 x IX series
F002	2 x IX series
F003	3 x IX series
F004	4 x IX series
F005	5 x IX series
F006	6 x IX series
F007	1 x FNR series mom-off-mom*
F008	1 x FNR series + 2 x IX series mom-off-mom
F009	1 x HR horizontal**
F010	2 x HR vertical**
F011	1 x HR series + 3x IX series**

REAR PLATE

FEATURE

MODIFIER

RXXX	No switches
R001	1 x IX series
R002	2 x IX series
R003	1 x FNR series on-off-on
R004	1 x FNR series mom-off-mom

XX None

None

NOTES:

* Standard option is a black FNR series, no marking. Many other options available (see APEM FNR datasheet)

** Standard option is a black HR series, single tab, 40% gain, single output. Many other options available (see APEM HR datasheet)

XP series

Mid-size flexible proportional joystick • non-contacting Hall effect technology

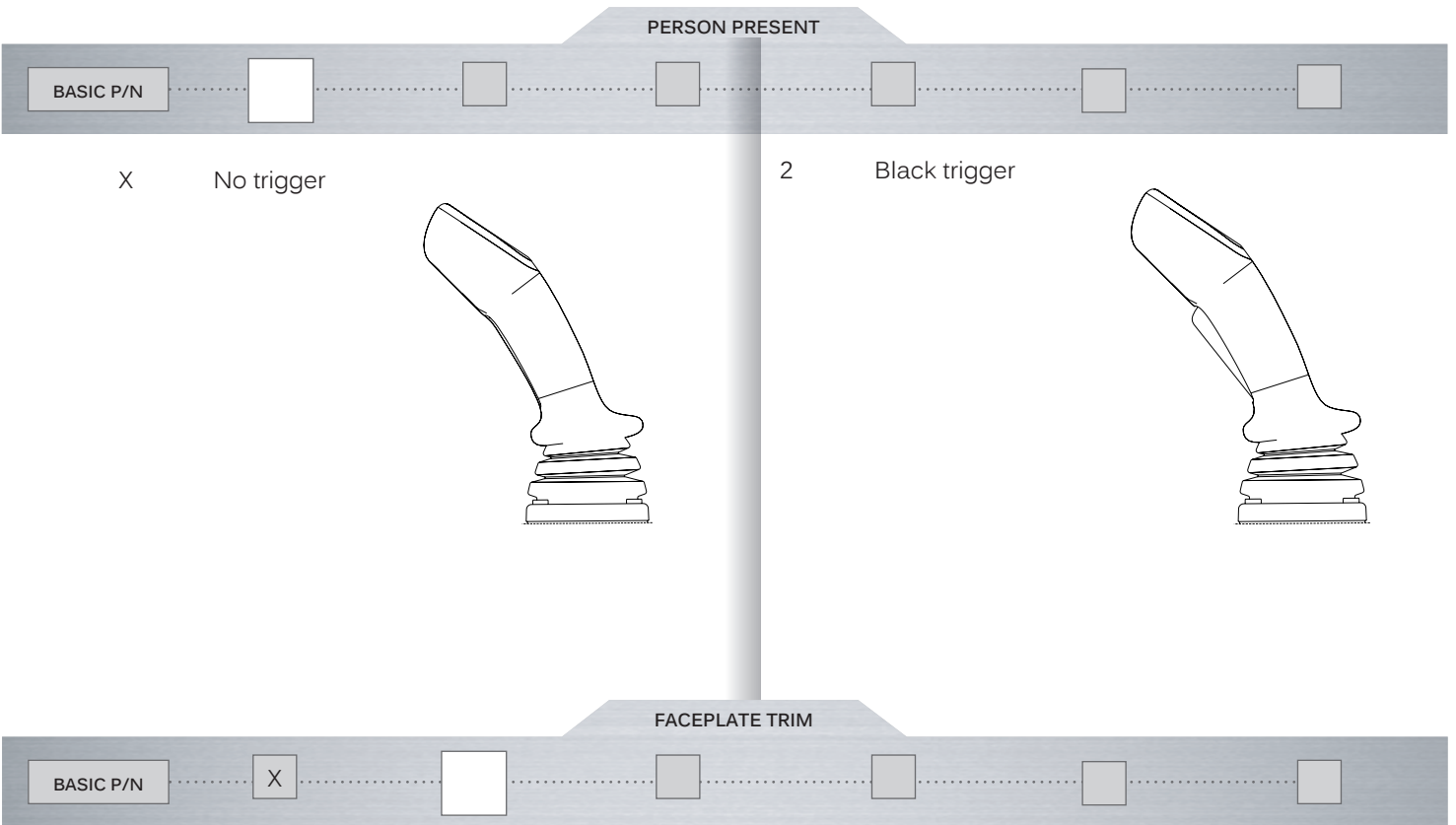

N1 Blue RAL 5012

N2 Black RAL 9011

N3 Green RAL 7044



XP series

Mid-size flexible proportional joystick •
non-contacting Hall effect technology

N4 Grey RAL 7044



N5 Yellow RAL 1023



N6 Red RAL 3031



N7 White RAL 1014



N9 Orange RAL 2009



XP series

Mid-size flexible proportional joystick • non-contacting Hall effect technology

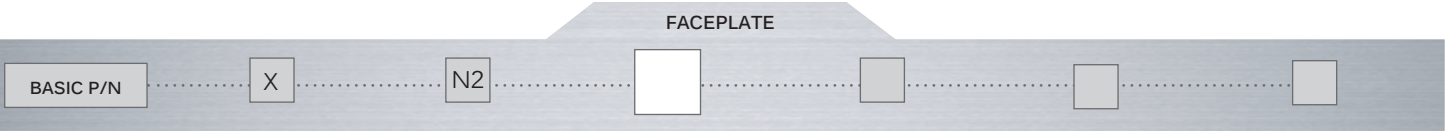

XX No switches

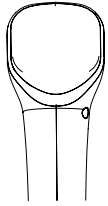

01 1 x IX series

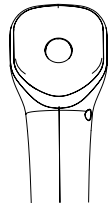

02 2 x IX series



03 3 x IX series

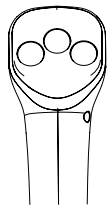

04 4 x IX series

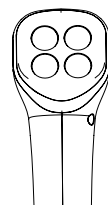

05 5 x IX series

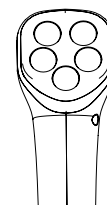

06 6 x IX series

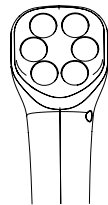

07 1 x FNR series

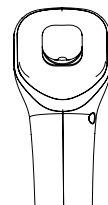

08 1 x FNR series + 2 x IX series



09 1 x HR series horizontal

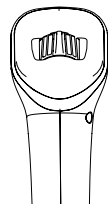

10 1 x HR series vertical

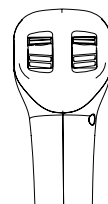

11 1 x HR series + 3x IX series

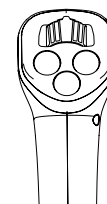

Custom options available

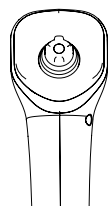

XP series

Mid-size flexible proportional joystick • non-contacting Hall effect technology

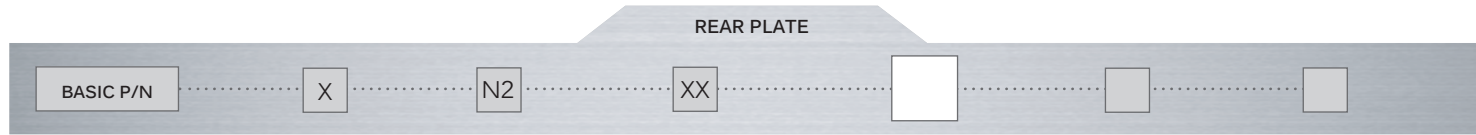

XX

None

01

1 x IX series

02

2 x IX series

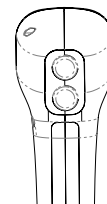
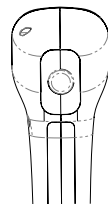
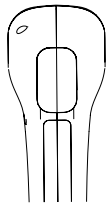

03

1 x FNR series on-off-on

04

Custom options available

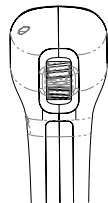
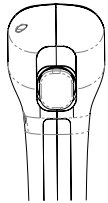

XP series

Mid-size flexible proportional joystick •
non-contacting Hall effect technology

XP series

Mid-size flexible proportional joystick • non-contacting Hall effect technology



VOLTAGE OUTPUT OPTIONS

SINGLE OUTPUT - CONFIGURATION 1

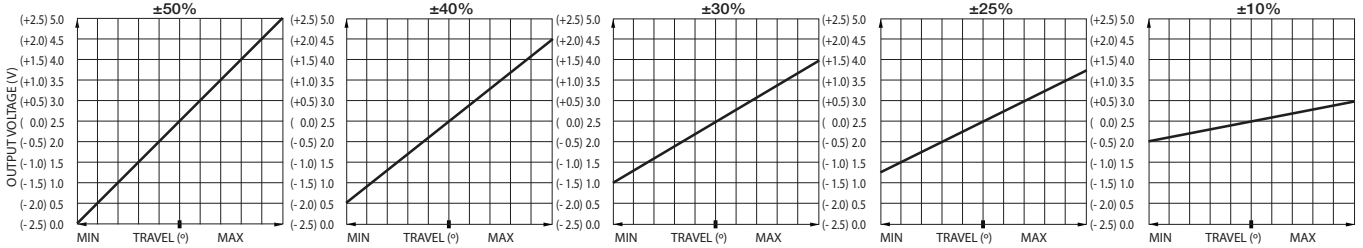

DUAL OUTPUT - CONFIGURATION 3

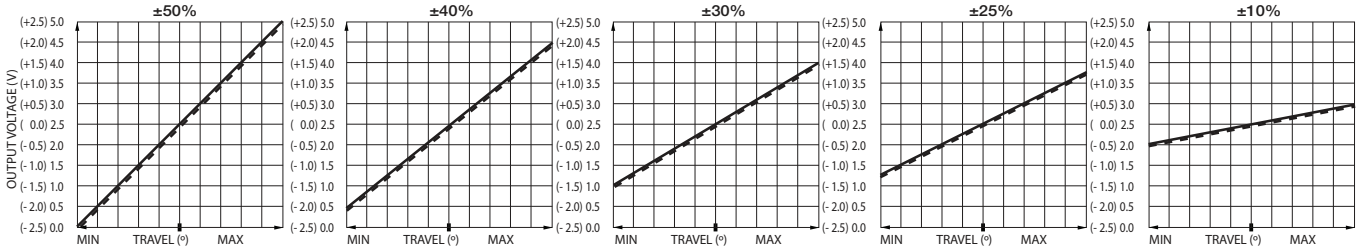

DUAL OUTPUT - CONFIGURATION 4

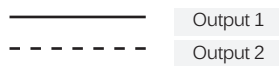
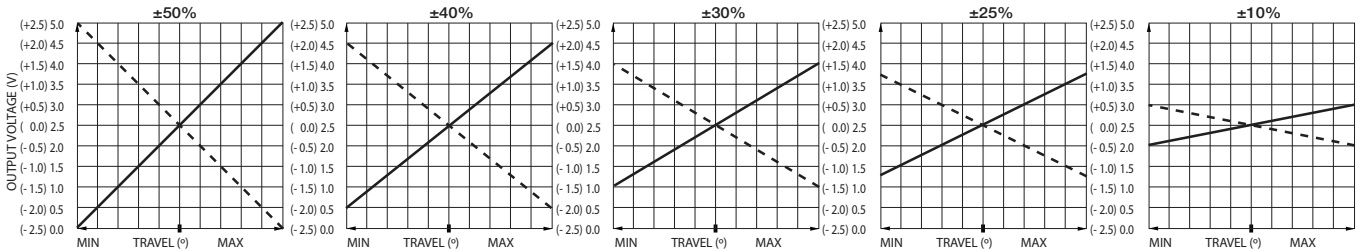

Mid-size flexible proportional joystick •
non-contacting Hall effect technology



CAN J1939 INTERFACE SPECIFICATION

The XP Series CAN options data is delivered on a CAN 2.0B compliant physical interface. Two additional signals allow configuration of the controller Source Address. Controller messages are delivered per the SAE J1939-71 message protocol.

CAN 2.0B INTERFACE PARAMETERS

- Baud rate: 250 kbps
- Transmission repetition rate: 50ms
- BJMI/EJMI interval time: 20ms
- Terminating resistor: No



CANopen INTERFACE SPECIFICATION

- Baud rate: 250 kbps
- Node ID: 20h
- Buttons: 1A0H (180H + NODE ID)
- Analog (axis) outputs: 2A0h (280h + Node ID)
- Heartbeat (500ms): 720h (700h + Node ID)
- Axis resolution: 8 bit
- Network Management: Auto start enabled

XP series

Mid-size flexible proportional joystick • non-contacting Hall effect technology



CONFIGURATION

POWER SUPPLY

The analogue XP series is designed to be powered by a regulated $5V \pm 0.5V$ power supply. The outputs are ratiometric, making a stable, noise free, power supply essential.

MAGNETIC IMMUNITY AND SYSTEM DESIGN

The XP series incorporates internal magnetic screening to minimise the effect of external magnetic fields. Mounting or operating the joystick close to strong magnetic fields is not recommended. System designers should follow best practice when incorporating the XP series joystick into their products.

Care should be taken to decouple the power supply properly and to employ adequate EMC shielding.

CENTER DETECT (CD)

Where selected, (configuration 1 types) the output on this additional cable will be 0V while the joystick is inactive. Should either the X or Y outputs change outside of the centre tolerance, indicating that the joystick has been operated, the centre detect signal will switch to 5 V.

Within the joystick this output is pulled high by a 2K2 resistor and is decoupled by a 100 nF capacitor to 0 V.

This output is designed for use in applications requiring an enable/disable signal that is separate from the main X, Y outputs. It is not recommended for use as a safety feature or a method of "person-present" detection.

CENTER TAP REFERENCE (CT)

Where selected, (configurations 1, 3 and 4) the joystick also outputs a centre reference voltage that is set at 50% ($\pm 1\%$) of the supply voltage.

This output can be used to check the integrity of the power supply applied to the joystick. A reading on this output, outside of the specified tolerance suggests a problem with the power supply to the joystick.

The other purpose of this output is to act as a reference equal to the voltage output when the lever is at centre.

Measuring the voltage outputs relative to CT rather than 0 V eliminates inaccuracies created by variation in supply voltage.

GAIN OPTIONS

The voltage output on the HE outputs, at full scale deflection is determined by the gain. The gain is expressed as a percentage of the voltage supplied. Therefore (assuming a 5V supply) a joystick specified with $\pm 25\%$ gain would yield 1.25 V at South, 2.5 V at centre and 3.75 V at North.

A range of gain options are available as standard for configurations 01, 03 and 04. For output options 05, 06 and 07, 40% gain is the default specification. All joysticks are supplied pre-set and no further calibration is needed throughout the lifetime of operation.

OUTPUT IMPEDANCE

The voltage outputs at centre and at each end of travel are specified across an infinite load, with no current flowing.

The output impedance specified in the electrical specification should be taken into account when designing a system. Load resistance of less than 10 K Ohms is not recommended.

MECHANISM

The omni-directional mechanism utilises an extremely robust ball-socket pivot. This construction yields an end product that is extremely resistant to vertical impact.

Furthermore, it constantly withstands high pull, push, rotational or horizontal forces that the product may be subject to, during life.

SPRINGING

All XP series are offered sprung to centre. The standard spring force requires 3 – 5N to off-centre the joystick.

GUIDED FEEL

The XP series is supplied as standard with guided feel. A joystick with guided feel moves more readily towards the poles (N, S, E and W) and whilst it can still move away from the poles, the force required to do so is greater. For non-guided feel please contract APEM for availability.

EXTERIOR COMPONENTS

APEM has a huge range of control components, and only some basic options have been included in the standard XP configuration. Many other options are available as a custom XP configuration, refer to individual component datasheets for details.