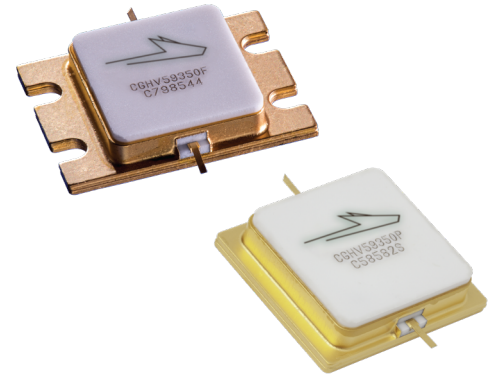


# CGHV59350

350 W, 5.2 - 5.9 GHz, 50-Ohm Input/Output Matched, GaN HEMT for C-Band Radar Systems

## Description

WolfSpeed's CGHV59350 is a gallium nitride (GaN) high electron mobility transistor (HEMT) designed specifically with high efficiency, high gain and wide bandwidth capabilities, which makes the CGHV59350 ideal for 5.2 - 5.9 GHz C-Band radar amplifier applications. The transistor is supplied in a ceramic/metal flange or pill package.



PN: CGHV59350F and CGHV59350P  
Package Type: 440217 and 440218

## Features

- 5.2 - 5.9 GHz Operation
- 470 W Typical Output Power
- 10.7 dB Power Gain
- 60% Typical PAE
- 50 Ohm Internally Matched
- <0.3 dB Pulsed Amplitude Droop

## Typical Performance Over 5.2 - 5.9 GHz ( $T_c = 25^\circ\text{C}$ ) of Demonstration Amplifier

Parameter	5.2 GHz	5.55 GHz	5.9 GHz	Units
Output Power	468	475	468	W
Gain	10.7	10.8	10.7	dB
Drain Efficiency	68	62	59	%

Notes:

<sup>1</sup> Measured in the CGHV59350-AMP under 100 $\mu\text{s}$  pulse width, 10% duty cycle,  $P_{IN} = 46 \text{ dBm}$

 Large Signal Models Available for ADS and MWO





## Absolute Maximum Ratings (not simultaneous)

Parameter	Symbol	Rating	Units	Conditions
Pulse Width	PW	100	μs	
Duty Cycle	DC	10	%	
Drain-Source Voltage	V <sub>DSS</sub>	150	V	25°C
Gate-to-Source Voltage	V <sub>GS</sub>	-10, +2		
Storage Temperature	T <sub>STG</sub>	-65, +150	°C	
Operating Junction Temperature	T <sub>J</sub>	225		
Maximum Forward Gate Current	I <sub>GMAX</sub>	64	mA	25°C
Maximum Drain Current <sup>1</sup>	I <sub>DMAX</sub>	24	A	
Soldering Temperature <sup>2</sup>	T <sub>S</sub>	245	°C	
Screw Torque	τ	40	in-oz	
Pulsed Thermal Resistance, Junction to Case	R <sub>θJC</sub>	0.31	°C/W	100μsec, 10%, 85°C, P <sub>DISS</sub> = 320 W
Case Operating Temperature <sup>3</sup>	T <sub>C</sub>	-40, +125	°C	

Notes:

<sup>1</sup> Current limit for long term, reliable operation

<sup>2</sup> Refer to the Application Note on soldering at [wolfspeed.com/rf/document-library](http://wolfspeed.com/rf/document-library)

<sup>3</sup> Refer to Figure 5 and Power Derating Curve on page 5 and 9, respectively.

## Electrical Characteristics

Characteristics	Symbol	Min.	Typ.	Max.	Units	Conditions
<b>DC Characteristics<sup>1</sup> (T<sub>C</sub> = 25°C)</b>						
Gate Threshold Voltage	V <sub>GS(th)</sub>	-3.8	-3.0	-2.3	V <sub>DC</sub>	V <sub>DS</sub> = 10 V, I <sub>D</sub> = 64 mA
Gate Quiescent Voltage	V <sub>GS(Q)</sub>	—	-2.7	—		V <sub>DS</sub> = 50 V, I <sub>D</sub> = 1.0 A
Saturated Drain Current <sup>2</sup>	I <sub>DS</sub>	41.6	59.5	—	A	V <sub>DS</sub> = 6.0 V, V <sub>GS</sub> = 2.0 V
Drain-Source Breakdown Voltage	V <sub>BR</sub>	125	—	—	V <sub>DC</sub>	V <sub>GS</sub> = -8 V, I <sub>D</sub> = 64 mA

Notes:

<sup>1</sup> Measured on wafer prior to packaging

<sup>2</sup> Scaled from PCM data



## Electrical Characteristics Continued

Characteristics	Symbol	Min.	Typ.	Max.	Units	Conditions
<b>RF Characteristics<sup>3</sup> (T<sub>C</sub> = 25°C, F<sub>0</sub> = 5.2 - 5.9 GHz unless otherwise noted)</b>						
Output Power at 5.2 GHz	P <sub>OUT</sub>	389	466	—	W	V <sub>DD</sub> = 50 V, I <sub>DQ</sub> = 1 A, P <sub>IN</sub> = 46 dBm
Output Power at 5.4 GHz		335	499	—		
Output Power at 5.8 GHz		302	446	—		
Output Power at 5.9 GHz			468	—		
Gain at 5.2 GHz	G <sub>P</sub>	—	10.7	—	dB	
Gain at 5.4 GHz		—	11	—		
Gain at 5.8 GHz		—	10.5	—		
Gain at 5.9 GHz		—	10.7	—		
Drain Efficiency at 5.2 GHz	η	53	68	—	%	
Drain Efficiency at 5.4 GHz		46	67	—		
Drain Efficiency at 5.8 GHz		40	58	—		
Drain Efficiency at 5.9 GHz			59	—		
Small Signal Gain	S <sub>21</sub>	11.50	15	—	dB	V <sub>DD</sub> = 50 V, I <sub>DQ</sub> = 1 A, P <sub>IN</sub> = -10 dBm
Input Return Loss	S <sub>11</sub>	—	-7	-3		
Output Return Loss	S <sub>22</sub>	—	-11			
Amplitude Droop	D	—	-0.3	—		V <sub>DD</sub> = 50 V, I <sub>DQ</sub> = 1 A, P <sub>IN</sub> = 46 dBm
Output Mismatch Stress	VSWR	—	—	5 : 1	Ψ	No damage at all phase angles, V <sub>DD</sub> = 50 V, I <sub>DQ</sub> = 1 A, P <sub>IN</sub> = 46 dBm Pulsed

Notes:

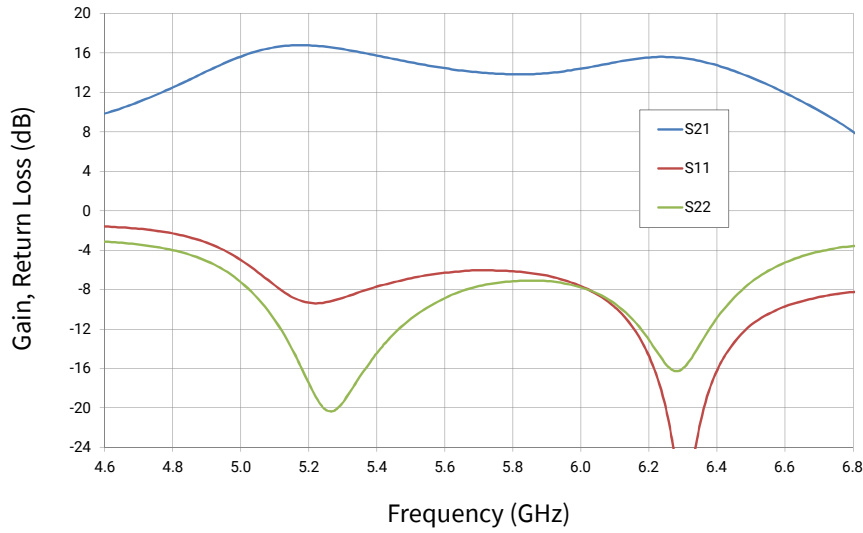
<sup>1</sup> Measured in CGHV59350-AMP. Pulse Width = 100μs, Duty Cycle = 10%

## Electrostatic Discharge (ESD) Classifications

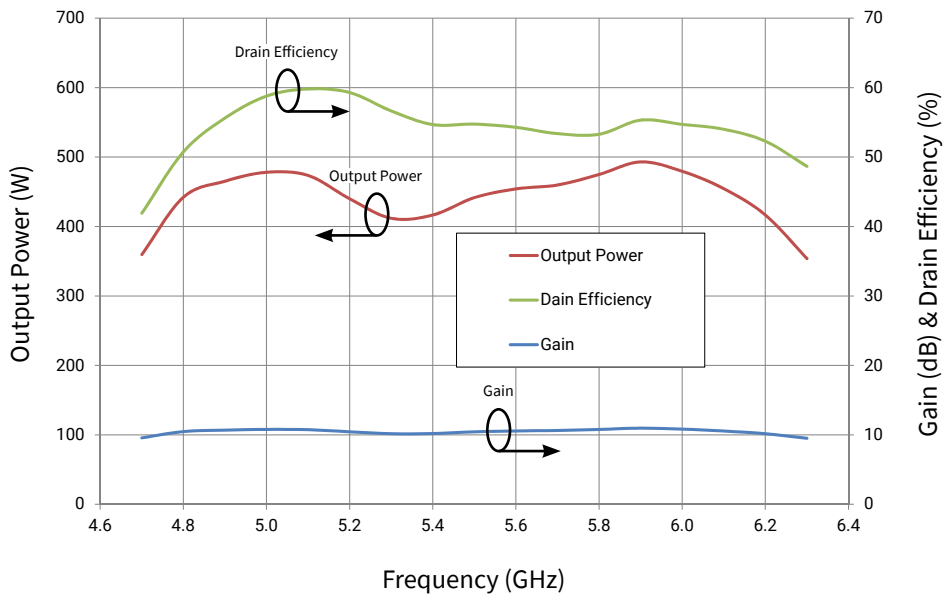
Parameter	Symbol	Class	Classification Level	Test Methodology
Human Body Model	HBM	500V	ANSI/ESDA/JEDEC JS-001 Table 3	JEDEC JESD22 A114-D
Charge Device Model	CDM	TBD	ANSI/ESDA/JEDEC JS-002 Table 3	JEDEC JESD22 C101-C



Typical Performance



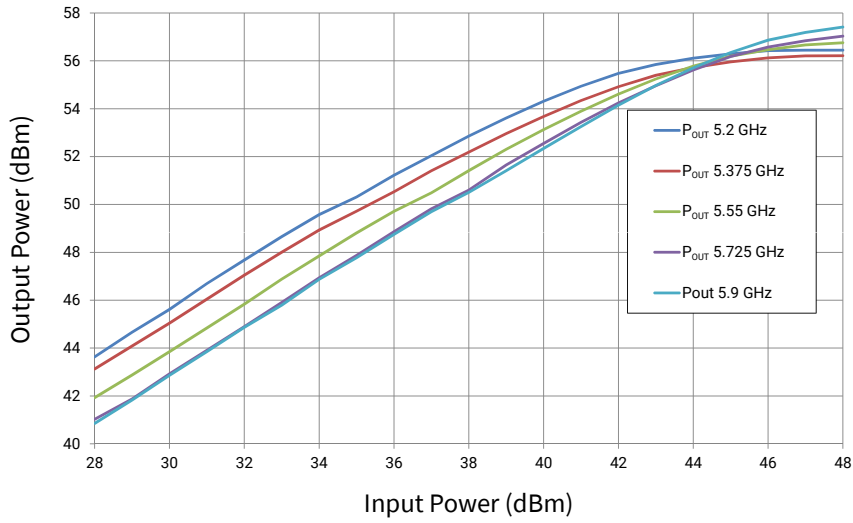
**Figure 1.** Small Signal S-Parameters for the CGHV59350F in Test Fixture CGHV59350F-TB  
 $V_{DD} = 50\text{ V}$ ,  $I_{DQ} = 1\text{ A}$ ,  $T_{CASE} = 25^\circ\text{C}$



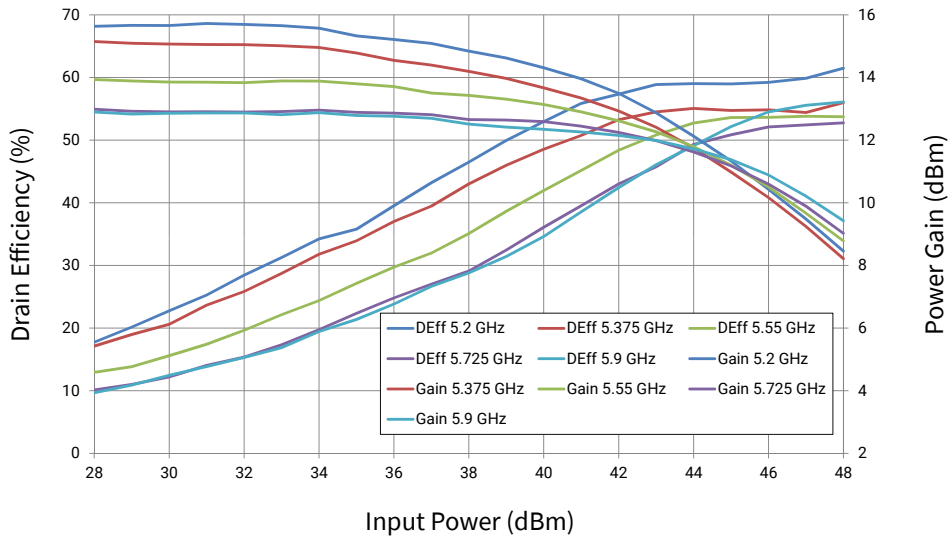
**Figure 2.** CGHV59350 Output Power, Drain Efficiency, and Gain vs Frequency at  $T_{CASE} = 25^\circ\text{C}$   
 $V_{DD} = 50\text{ V}$ ,  $I_{DQ} = 1.0\text{ A}$ ,  $P_{IN} = 46\text{ dBm}$ , Pulse Width =  $100\mu\text{s}$ , Duty Cycle = 10%



Typical Performance

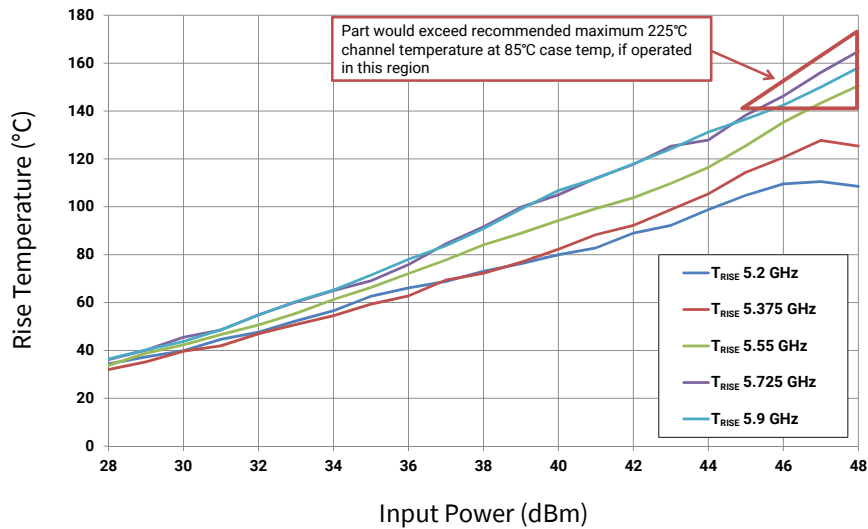


**Figure 3.** CGHV59350 Output Power vs Input Power  
 $V_{DD} = 50\text{ V}$ ,  $I_{DQ} = 1.0\text{ A}$ , Pulse Width =  $100\mu\text{s}$ , Duty Cycle = 10%,  $T_{CASE} = 25^\circ\text{C}$

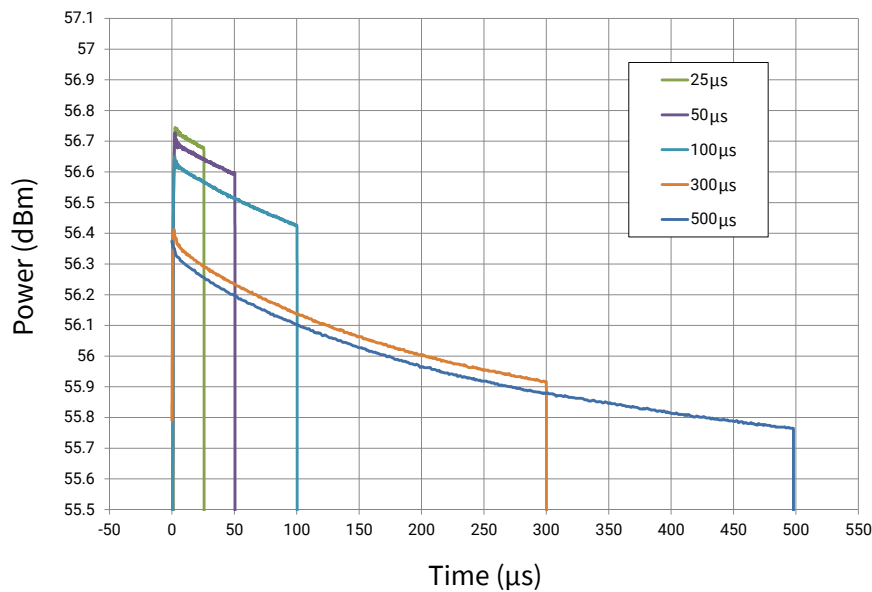


**Figure 4.** CGHV59350 Drain Efficiency and Gain vs Input Power as a Function of Frequency  
 $V_{DD} = 50\text{ V}$ ,  $I_{DQ} = 1.0\text{ A}$ , Pulse Width =  $100\mu\text{s}$ , Duty Cycle = 10%,  $T_{CASE} = 25^\circ\text{C}$

Typical Performance

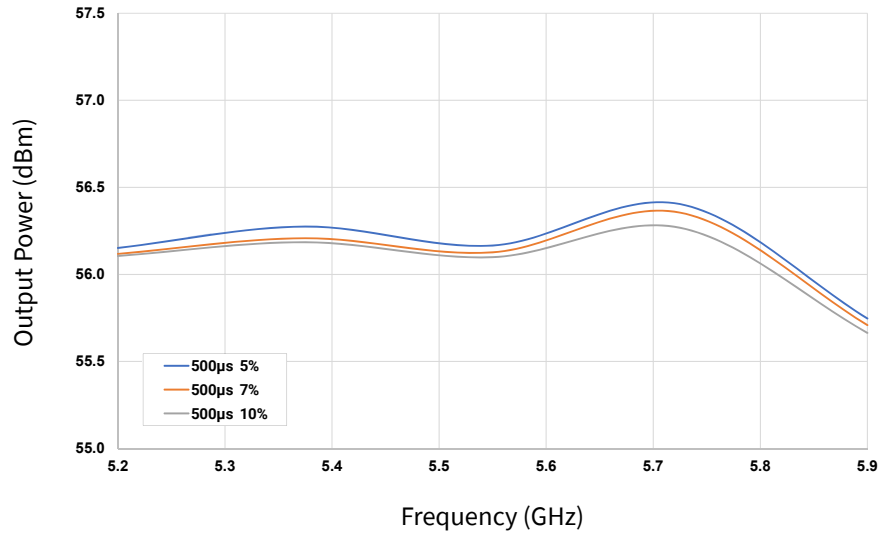


**Figure 5.** CGHV59350 Rise Temperature vs. Input Power  
 $V_{DD} = 50\text{ V}$ ,  $I_{DQ} = 1\text{ A}$ , Pulse Width =  $100\mu\text{s}$ , Duty Cycle = 10%,  $T_{CASE} = 25^\circ\text{C}$

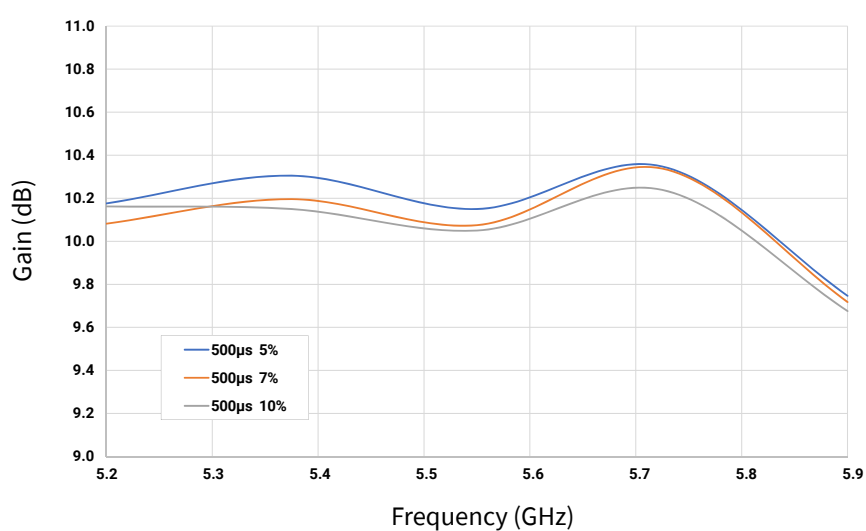


**Figure 6.** CGHV59350 Output Power vs. Time  
 $V_{DD} = 50\text{ V}$ ,  $P_{IN} = 46\text{ dBm}$ , Duty Cycle = 10%

## Typical Performance



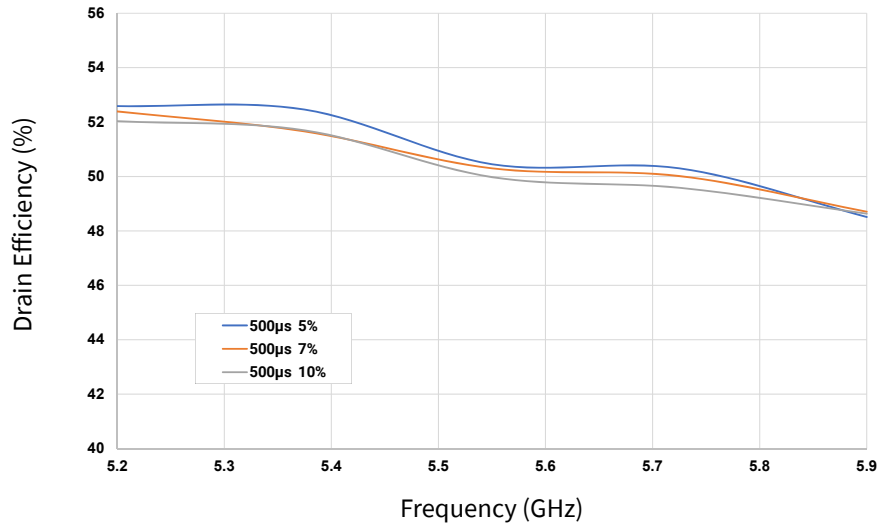
**Figure 7.** CGHV59350 Output Power vs. Frequency  
 $V_{DD} = 50\text{ V}$ ,  $I_{DQ} = 1\text{ A}$ ,  $P_{IN} = 46\text{ dBm}$ , Pulse Width =  $500\mu\text{s}$ , Duty Cycle = 5%, 7%, 10%



**Figure 8.** CGHV59350 Gain vs. Frequency  
 $V_{DD} = 50\text{ V}$ ,  $P_{IN} = 46\text{ dBm}$ , Pulse Width =  $500\mu\text{s}$ , Duty Cycle = 5%, 7%, 10%



### Typical Performance



**Figure 9.** CGHV59350 Drain Efficiency vs. Frequency  
 $V_{DD} = 50\text{ V}$ ,  $I_{DQ} = 1\text{ A}$ ,  $P_{IN} = 46\text{ dBm}$ , Pulse Width =  $500\mu\text{s}$ , Duty Cycle = 5%, 7%, 10%

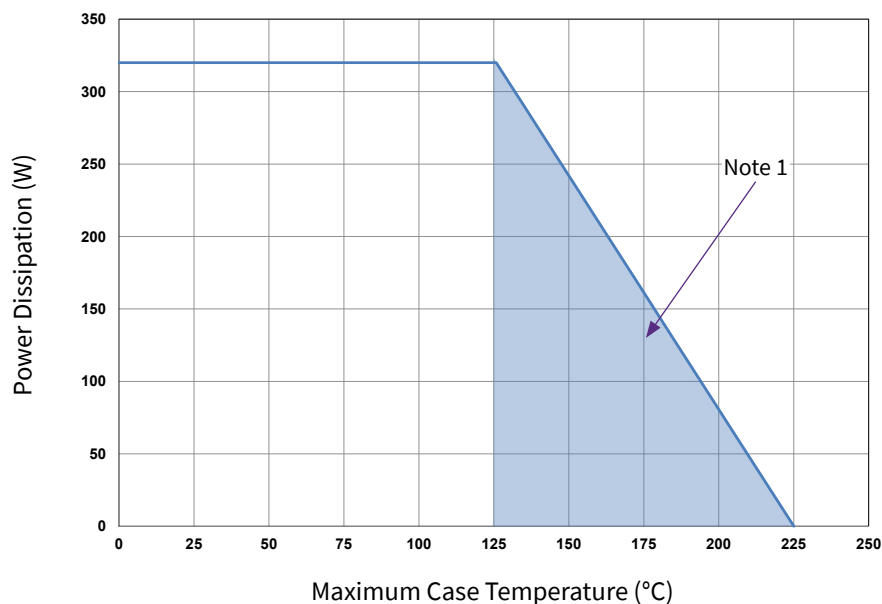




## CGHV59350-AMP2 Application Circuit Bill of Materials

Designator	Description	Qty
R1	RES, 1/16W, 0603, 1%, 5.1 Ohms	1
R2	RES, 1/16W, 0603, 1%, 10.0 Ohms	1
C1, C2	CAP, 5.6pF +/- 0.1pF, 0603	2
C3, C8	CAP, 20.0pF, +/-5%, 0603	2
C4, C9	CAP, 470PF, 5%, 100V, 0603, X7R	2
C5, C16	CAP, 0.1uF, +/-10%, 250V, 1206, X7R	2
L1	IND, FERRITE, 220 OHM, 0603	1
C10	CAP, 1.0uF, 100V, 10%, X7R, 1210	1
C7	CAP, 5.6 PF +/- 0.1 pF, 0805, ATC 600F	1
C11	CAP, 3300uF, +/-20%, 100V, ELECTROLYTIC	1
C12	CAP, 33uF, 20%, G CASE	1
C13	CAP TANT 10UF 10% 16V 2312	1
C14, C17	CAP, 0.01 uF, +/-10%, 250V, 0805, X7R DIELECTRIC	2
C15, C18	CAP, 1000pF, +/-5%, 0603	2
J1, J2	CONN, SMA, PANEL MOUNT JACK, FLANGE, 4-HOLE, BLUNT POST	2
J3	HEADER RT>PLZ .1CEN LK 9POS	1
J4	CONNECTOR; SMB, Straight, JACK,SMD	1
W1	CABLE, 18 AWG, 4.2"	1
-	PCB, TEST FIXTURE, TACONIC RF35P 20MIL OVER 0.250 COPPER BACK, 2.5 X 3 X 0.26", CGHV59350-TB	1
-	2-56 SOC HD SCREW 1/4 SS	4
-	#2 SPLIT LOCKWASHER SS	4
Q1	CGHV59350	1

## CGHV59350 Power Dissipation De-rating Curve



Note

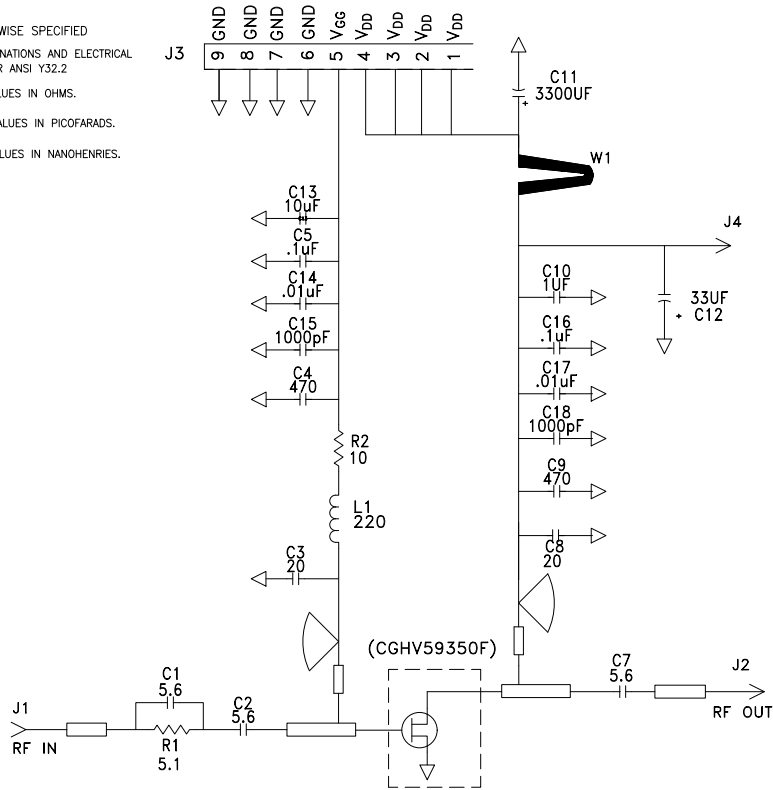
<sup>1</sup> Area exceeds Maximum Case Temperature (See Page 2).



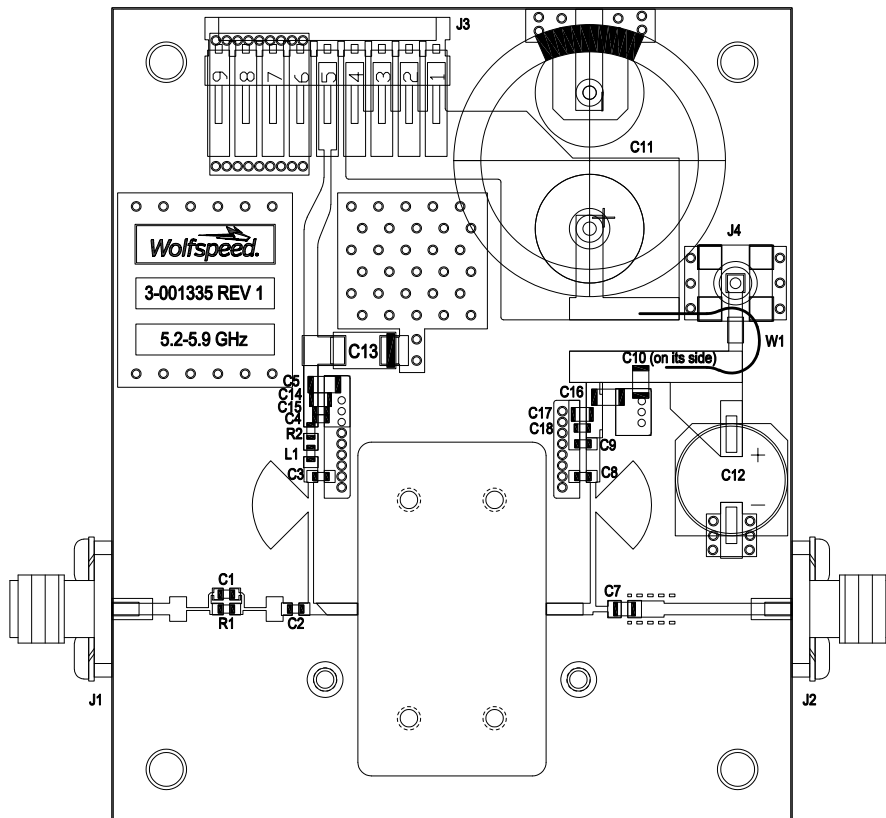
### CGHV59350-AMP2 Application Circuit Schematic

NOTES: UNLESS OTHERWISE SPECIFIED

1. REFERENCE DESIGNATIONS AND ELECTRICAL SYMBOLS ARE PER ANSI Y32.2
2. ALL RESISTOR VALUES IN OHMS.
3. ALL CAPACITOR VALUES IN PICOFARADS.
4. ALL INDUCTOR VALUES IN NANOHENRIES.



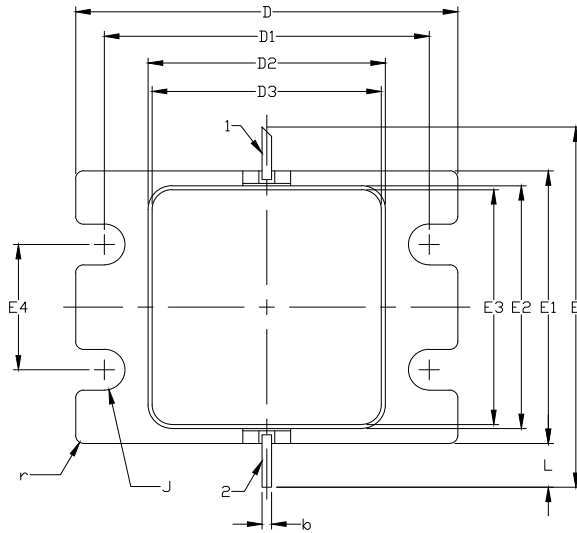
### CGHV59350-AMP2 Application Circuit Outline





### Product Dimensions CGHV59350F (Package Type — 440217)

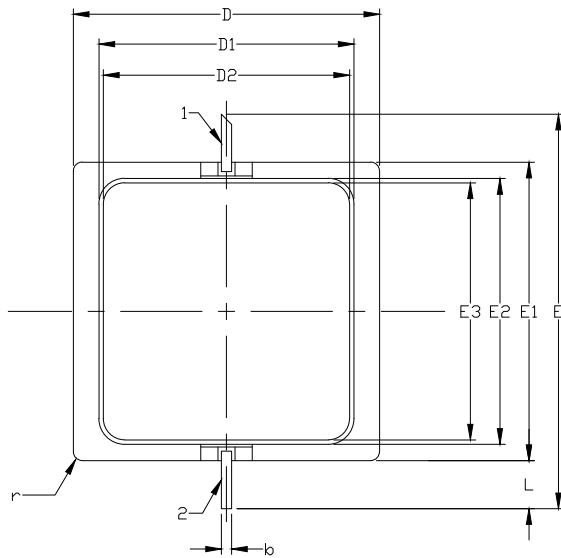
- NOTES: (UNLESS OTHERWISE SPECIFIED)
1. INTERPRET DRAWING IN ACCORDANCE WITH ANSI Y14.5M-2009
  2. ADHESIVE FROM LID MAY EXTEND A MAXIMUM OF .020 BEYOND EDGE OF LID
  3. LID MAY BE MISALIGNED TO THE BODY OF PACKAGE BY A MAXIMUM OF .008 IN ANY DIRECTION
  4. ALL PLATED SURFACES ARE GOLD OVER NICKEL



1. GATE  
2. DRAIN

DIM	INCHES		MILLIMETERS		NOTES
	MIN	MAX	MIN	MAX	
A	0.188	0.198	4.78	5.03	
A1	0.088	0.100	2.24	2.54	2x
A2	0.049	0.061	1.24	1.55	
b	0.022	0.026	0.56	0.66	2x
c	0.002	0.006	0.05	0.15	
D	0.935	0.955	23.75	24.26	
D1	0.797	0.809	20.24	20.55	2x
D2	0.581	0.593	14.76	15.06	
D3	0.563	0.571	14.30	14.50	
E	0.906		23.01		REF
E1	0.679	0.691	17.25	17.55	
E2	0.604	0.616	15.34	15.65	
E3	0.586	0.594	14.88	15.09	
E4	0.309	0.321	7.85	8.15	2x
J	∅0.097	∅0.107	∅2.46	∅2.72	4x
L	0.090	0.130	2.29	3.30	2x
r	0.02	TYP	0.51	TYP	12x

### Product Dimensions CGHV59350P (Package Type — 440218)



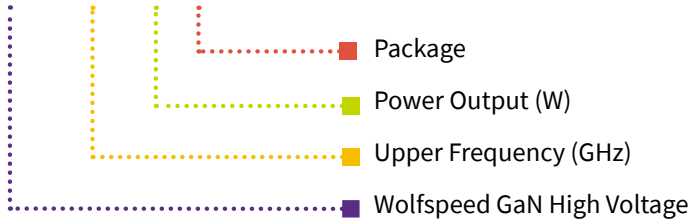
1. GATE  
2. DRAIN

DIM	INCHES		MILLIMETERS		NOTES
	MIN	MAX	MIN	MAX	
A	0.188	0.198	4.78	5.03	
A1	0.088	0.100	2.24	2.54	2x
A2	0.049	0.061	1.24	1.55	
b	0.022	0.026	0.56	0.66	2x
c	0.002	0.006	0.05	0.15	
D	0.698	0.712	17.72	18.08	
D1	0.581	0.593	14.76	15.06	
D2	0.563	0.571	14.30	14.50	
E	0.906		23.01		REF
E1	0.679	0.691	17.25	17.55	
E2	0.604	0.616	15.34	15.65	
E3	0.586	0.594	14.88	15.09	
J	∅0.097	∅0.107	∅2.46	∅2.72	4x
L	0.090	0.130	2.29	3.30	2x
r	0.02	TYP	0.51	TYP	12x



**Part Number System**

**CGHV59350F**



**Table 1.**

Parameter	Value	Units
Upper Frequency <sup>1</sup>	5.9	GHz
Power Output	350	W
Package	F = Flange, P = Pill	—

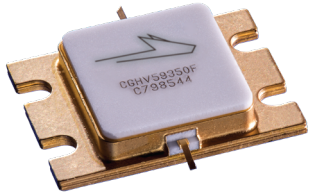
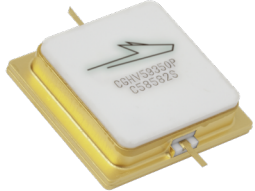
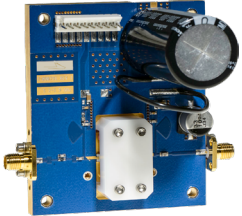
Note:  
<sup>1</sup> Alpha characters used in frequency code indicate a value greater than 9.9 GHz. See Table 2 for value.

**Table 2.**

Character Code	Code Value
A	0
B	1
C	2
D	3
E	4
F	5
G	6
H	7
J	8
K	9
Examples:	1A = 10.0 GHz 2H = 27.0 GHz



## Product Ordering Information

Order Number	Description	Unit of Measure	Image
CGHV59350F	GaN HEMT	Each	
CGHV59350P	GaN HEMT	Each	
CGHV59350F-AMP2	Test board with GaN HEMT installed	Each	

**For more information, please contact:**

4600 Silicon Drive  
Durham, NC 27703 USA  
Tel: +1.919.313.5300  
[www.wolfspeed.com/RF](http://www.wolfspeed.com/RF)

Sales Contact  
[RFSales@wolfspeed.com](mailto:RFSales@wolfspeed.com)

RF Product Marketing Contact  
[RFMarketing@wolfspeed.com](mailto:RFMarketing@wolfspeed.com)

## Notes & Disclaimer

---

Specifications are subject to change without notice. “Typical” parameters are the average values expected by Wolfspeed in large quantities and are provided for information purposes only. Wolfspeed products are not warranted or authorized for use as critical components in medical, life-saving, or life-sustaining applications, or other applications where a failure would reasonably be expected to cause severe personal injury or death. No responsibility is assumed by Wolfspeed for any infringement of patents or other rights of third parties which may result from use of the information contained herein. No license is granted by implication or otherwise under any patent or patent rights of Wolfspeed.

© 2015-2023 Wolfspeed, Inc. All rights reserved. Wolfspeed® and the Wolfstreak logo are registered trademarks and the Wolfspeed logo is a trademark of Wolfspeed, Inc.  
PATENT: <https://www.wolfspeed.com/legal/patents>

*The information in this document is subject to change without notice.*