

## HPLC Series

Wakefield-Vette's High Performance HPLC Series Compact Liquid Chiller, with circulating fluid temperature controller. CE marking and UL compliant with timer operations and alarming codes on 7 segment / 4 digit 2 row display. The HRS chiller has both air cooled and water cooled options available. Two power supplies are also available, 115VAC and 230 VAC single phase.

### Features:

- Easy Maintenance, Tool-less Filter Replacement
- Operating Functions: Timer, Low Tank Level, Power Failure
- Self-Diagnosis with 31 Types of Alarm Codes
- Serial Communications and Input/Outputs as Standard
- Shaped for Easy Supply of Circulating Fluid
- Dustproof Filter
- Unfixed Caster for Useful Transportation
- Environmental Compliance: RoHS Directive, R407C Refrigerant
- Power Failure Auto-Restart Function
- Large Cooling Capacity

### Applications:

- Laser Machining
- UV Curing Devices
- X-Ray Instruments
- Electron Microscopes
- Atomizing Devices
- Temperature Control of Paint Material
- Packaging Lines
- Cooling of Vacuum Pumps



### **HPLC-10**

Cooling capacities: 1.3 kW-1.7 kW

Temperature range setting: 5 to 40°C

Temperature stability:  $\pm 0.1^\circ\text{C}$

Power supply requirement: single phase 100 VAC, 50/60Hz or 115 VAC, 60Hz

Standards: CE, UL, RoHS

Circulating fluid: Tap water or 15% ethylene glycol solution

### **HPLC-20**

Cooling capacities: 1.4 kW-1.9 kW

Temperature range setting: 5 to 40°C

Temperature stability:  $\pm 0.1^\circ\text{C}$

Power supply requirement: single phase 200 to 230 VAC, 50/60Hz

Standards: CE, UL, RoHS

Circulating fluid: Tap water or 15% ethylene glycol solution

### **HPLC-BP1**

Bypass kit for use with HPLC-10 & HPLC-20 to maintain minimum flow rate of 7 l/min to keep the system running properly.

# High Performance Compact Re-Circulating Liquid Chillers

## HPLC Series

### HPLC-10



Cooling method		Air-cooled refrigeration	
Refrigerant		R407C (HFC)	
Control method		PID control	
Ambient temperature/humidity <sup>1)</sup>		Temperature: 5 to 40°C, Humidity: 30 to 70%	
Circulating fluid		Clear water, 15% ethylene glycol aqueous solution	
Circulating fluid system	Temperature range setting (°C)	5 to 40	
	Cooling capacity (50/60 Hz) (W)	1100/1300	
	Heating capacity (50/60 Hz) (W)	360/450	
	Temperature stability (°C)	±0.1	
	Pump	Rated flow (50/60 Hz) (L/min)	7 (0.13 MPa)/7 (0.18 MPa)
		Maximum flow rate (50/60 Hz) (L/min)	27/29
		Maximum high-lift (50/60 Hz) (m)	14/19
		Output (W)	200
	Tank capacity (L)	Approx. 5	
	Port size	Rc1/2	
Wetted parts material	Stainless steel, Copper (Heat exchanger brazing), Bronze, Alumina ceramic, Carbon, PP, PE, POM, FKM, EPDM, PVC		
Facility water system	Port size	Rc3/8	
	Wetted parts material	Stainless steel, Copper (Heat exchanger brazing), Bronze, Synthetic rubber	
Electrical system	Power supply	Single-phase 100 VAC (50/60 Hz), 115 VAC (60 Hz) Allowable voltage range ±10%	
	Circuit protector (A)	15	
	Applicable earth leakage breaker capacity (A)	15	
	Rated operating current (A)	7.5/8.3	
	Rated power consumption (50/60 Hz) (kVA)	0.7/0.8	
Noise level (50/60 Hz) (dB)	58/55		
Accessories	Fitting (for drain outlet) 1 pc., Input/output signal connector 1 pc., Power supply connector 1 pc., Operation manual (for installation/operation) 1, Quick manual (with a clear case) 1, Alarm code list sticker 1, Ferritic core (for communication) 1 pc. Power supply cable should be ordered the option (sold separately) or prepared by the customer.		
Weight (kg)	40		

### Cooling Capacity

(Single-phase 100/115 VAC) [50 Hz]

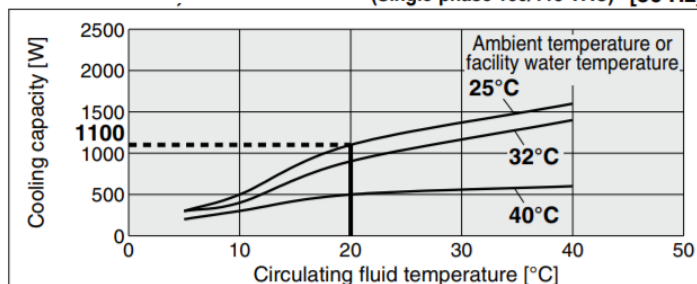

[60 Hz]

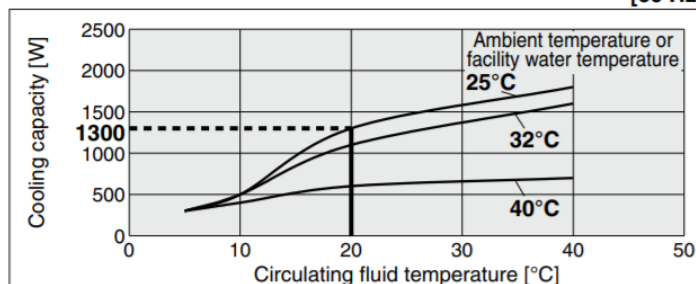

### Heating Capacity

(Single-phase 100/115 VAC) [50 Hz]

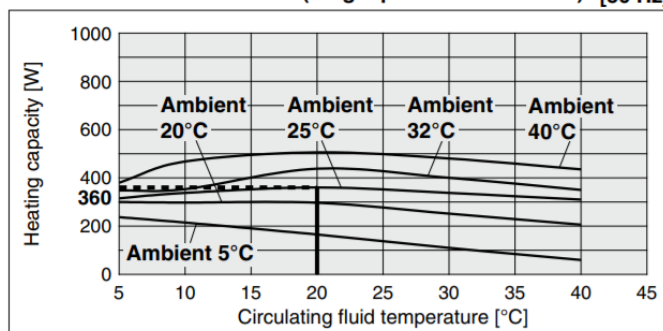

[60 Hz]

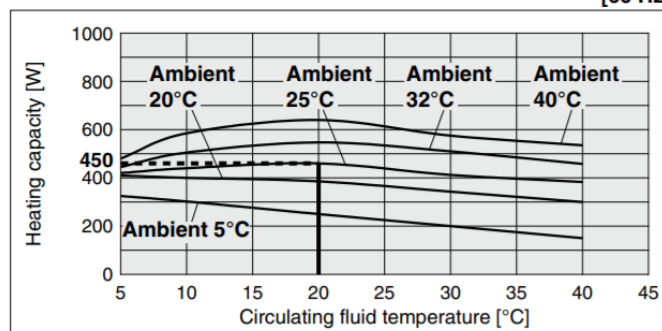

### Pump Capacity

(Single-phase 100/115 VAC)

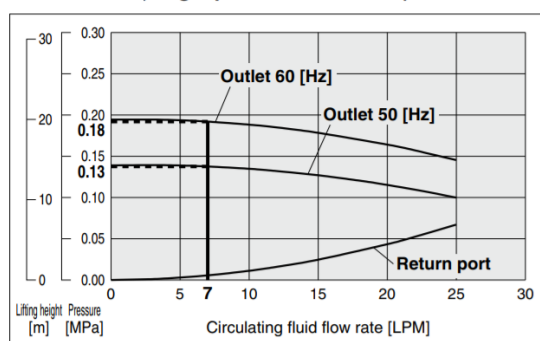

### Required Facility Flow Rate

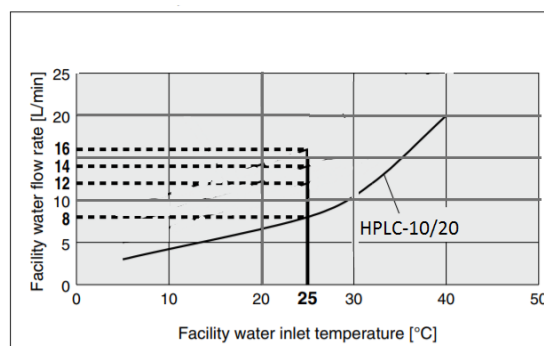

\* This is the facility water flow rate at the circulating fluid rated flow rate and the cooling capacity listed in the "Cooling Capacity" specifications.

# High Performance Compact Re-Circulating Liquid Chillers

## HPLC Series

### HPLC-20



<b>Cooling method</b>	Air-cooled refrigeration
<b>Refrigerant</b>	R407C (HFC)
<b>Control method</b>	PID control
<b>Ambient temperature/humidity</b>	Temperature: 5 to 40°C, High-temperature environment specifications (option): 5 to 45°C, Humidity: 30 to 70%
<b>Circulating fluid</b>	Clear water, 15% ethylene glycol aqueous solution
<b>Temperature range setting (°C)</b>	5 to 40
<b>Cooling capacity (50/60 Hz) (W)</b>	1100/1300
<b>Heating capacity (50/60 Hz) (W)</b>	530/650
<b>Temperature stability (°C)</b>	±0.1
<b>Pump</b>	
Rated flow (50/60 Hz) (L/min)	7 (0.13 MPa)/7 (0.18 MPa)
Maximum flow rate (50/60 Hz) (L/min)	27/29
Maximum high-lift (50/60 Hz) (m)	14/19
Output (W)	200
Tank capacity (L)	Approx. 5
Port size	Rc1/2
<b>Wetted parts material</b>	Stainless steel, Copper (Heat exchanger brazing), Bronze, Alumina ceramic, Carbon, PP, PE, POM, FKM, EPDM, PVC
<b>Facility water system (Note 1)</b>	
Temperature range (°C)	—
Pressure range (MPa)	—
Required flow rate (50/60 Hz) (L/min)	—
Inlet-outlet pressure differential of facility water (MPa)	—
Port size	Rc3/8
<b>Wetted parts material</b>	Stainless steel, Copper (Heat exchanger brazing), Bronze, Synthetic rubber
<b>Power supply</b>	Single-phase 200 to 230 VAC (50/60 Hz) Allowable voltage range ±10%
<b>Electrical system</b>	
Circuit protector (A)	10
Applicable earth leakage breaker capacity (A)	10
Rated operating current (A)	4.6/5.1
Rated power consumption (50/60 Hz) (kVA)	0.9/1.0
<b>Noise level (50/60 Hz) (dB)</b>	60/61
<b>Accessories</b>	Fitting (for drain outlet) 1 pc., Note 13), Input/output signal connector 1 pc., Power supply connector 1 pc., Note 13), Operation manual (for installation/operation) 1, Quick manual (with a clear case) 1 Note 13), Alarm code list sticker 1, Ferritic core (for communication) 1 pc. Power supply cable should be ordered the option (sold separately) or prepared by the customer.
<b>Weight (kg)</b>	43

### Cooling Capacity

(Single-phase 200 to 230 VAC) [50 Hz]

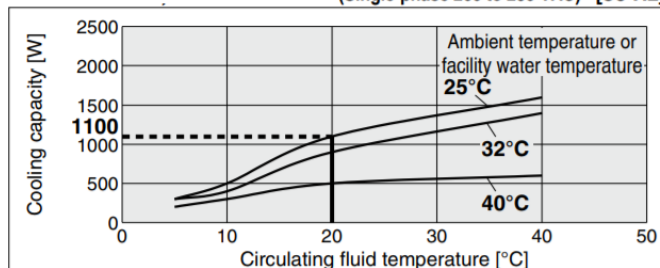

[60 Hz]

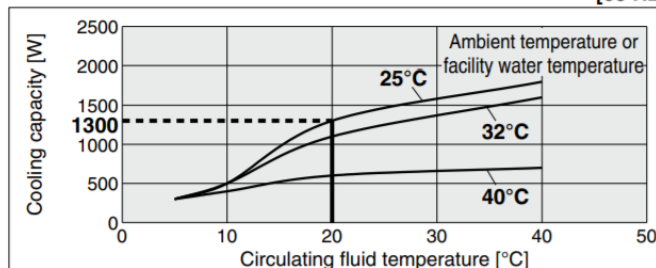

### Heating Capacity

(Single-phase 200 to 230 VAC) 50 Hz]

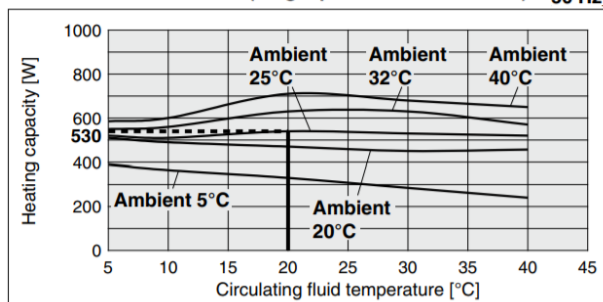

[60 Hz]

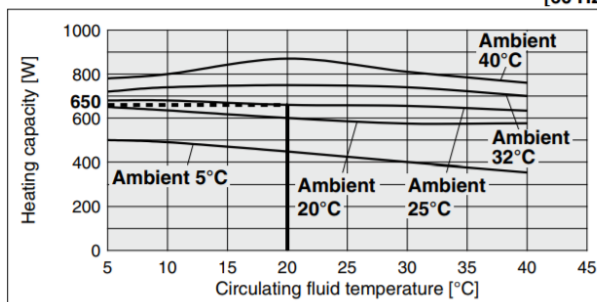

### Pump Capacity

(Single-phase 200 to 230 VAC)

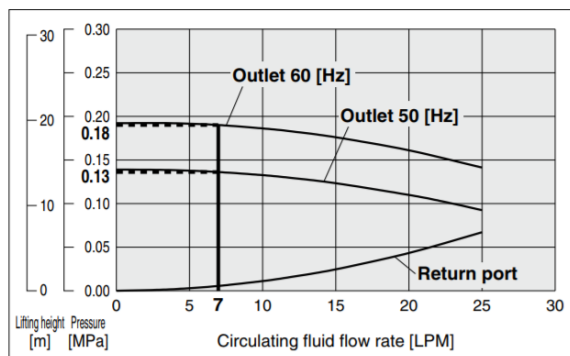

### Required Facility Flow Rate

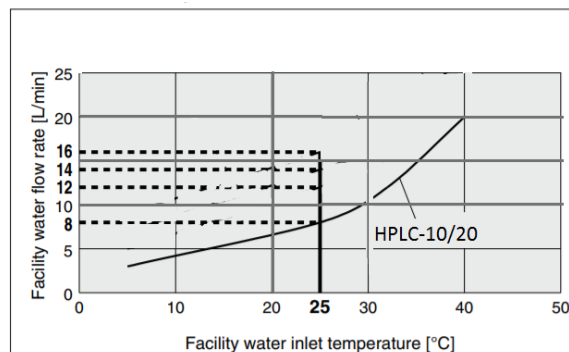

\* This is the facility water flow rate at the circulating fluid rated flow rate and the cooling capacity listed in the "Cooling Capacity" specifications.

## HPLC Series

### Dimensions HPLC-10/20

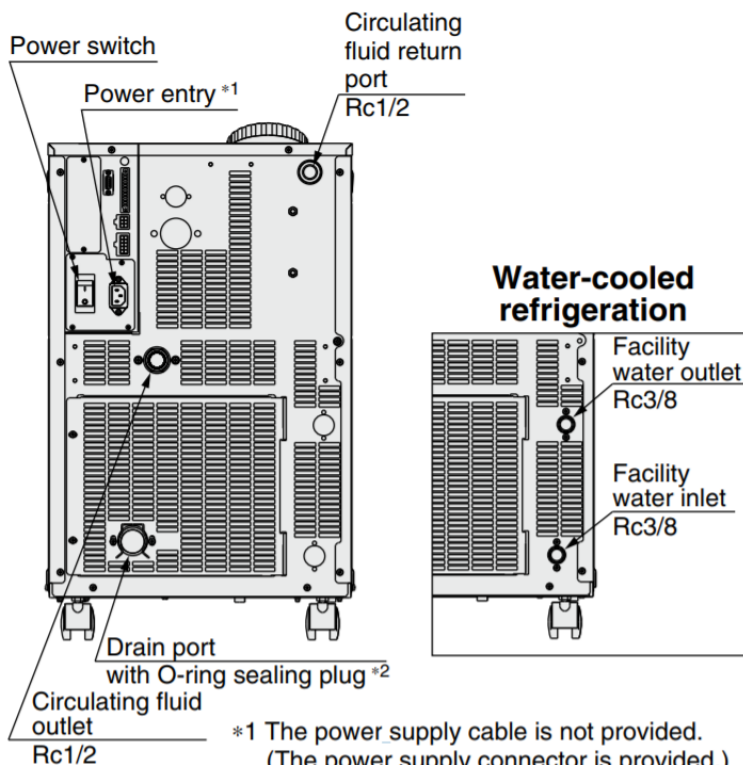
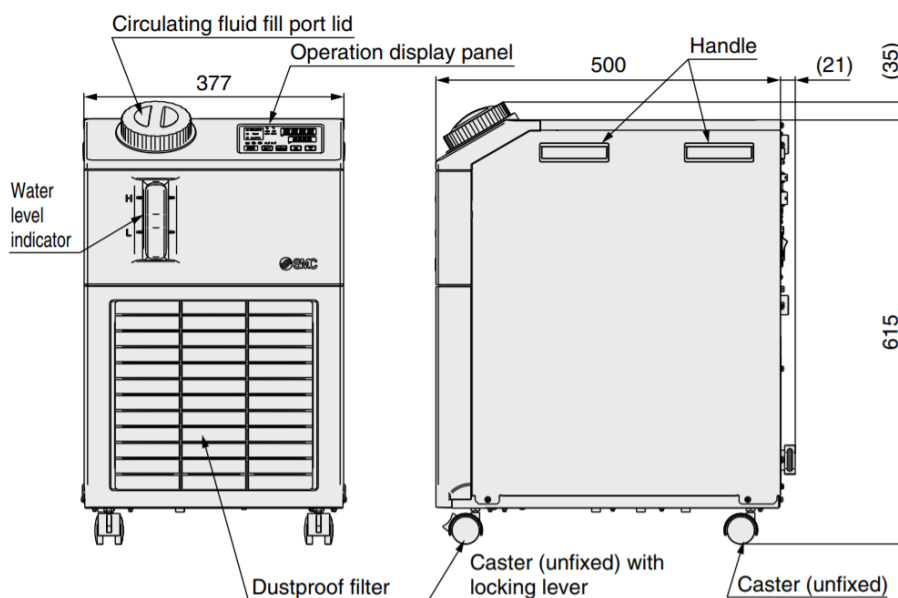
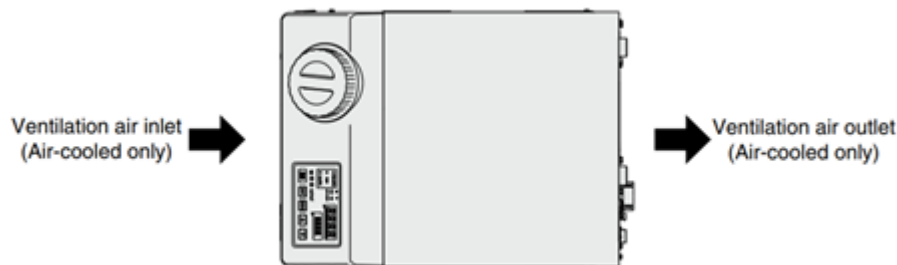

\*1 The power supply cable is not provided. (The power supply connector is provided.)

\*2 The conversion fitting (R3/8 male thread) is provided.

## HPLC Series

### **HPLC-BP1**

Bypass kit for use with HPLC-10 & HPLC-20 to maintain minimum flow rate of 7 l/min to keep the system running properly.

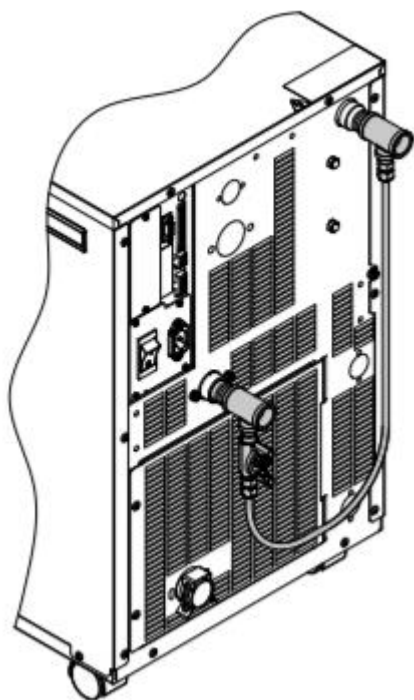

Note) To be mounted by user.

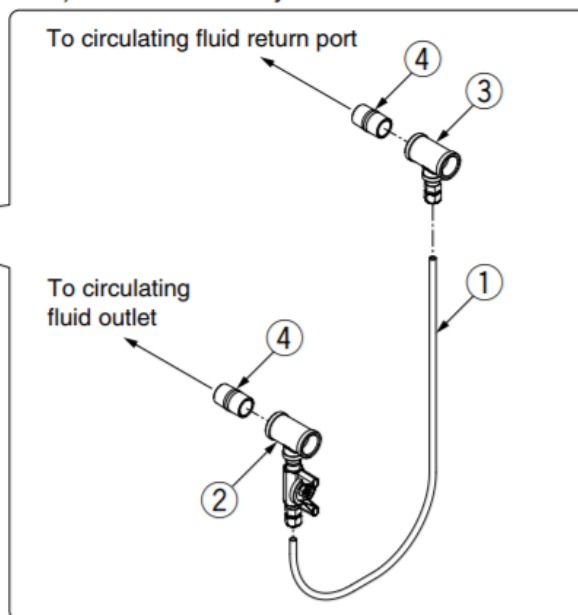

### **Parts List**

No.	Description
①	Bypass tube (700 mm) (Part no.: TL0806)
②	Outlet piping (with ball valve)
③	Return port piping
④	Nipple (Size: 1/2) (2 pcs.)

## HPLC Series

### Manual HPLC-10/20

#### Mounting/Installation

##### **Warning**

1. Do not use the product outdoors.
2. Do not place heavy objects on top of this product, or step on it.

The external panel can be deformed and danger can result.

##### **Caution**

1. Install on a rigid floor which can withstand this product's weight.
2. Secure with bolts, anchor bolts, etc.

Fasteners such as bolts or anchor bolts should be tighten with the recommended torque shown below.

##### Fixing Thread Tightening Torque

Connection thread	Applicable tightening torque (N·m)	Connection thread	Applicable tightening torque (N·m)
M3	0.63	M8	12.5
M4	1.5	M10	24.5
M5	3	M12	42
M6	5.2		

#### Piping

##### **Caution**

1. Regarding the circulating fluid pipings, consider carefully the suitability for shutoff pressure, temperature and circulating fluid.

If the operating performance is not sufficient, the pipings may burst during operation.

2. Select the piping port size which can exceed the rated flow.

For the rated flow, refer to the pump capacity table.

3. When tightening at the circulating fluid inlets and outlets, drain port or overflow outlet of this product, use a pipe wrench to clamp the connection ports.

4. For the circulating fluid piping connection, install a drain pan and wastewater collection pit just in case the circulating fluid may leak.

5. This product series consists of circulating fluid temperature controllers with built-in tanks.

Do not install equipment on your system side such as pumps that forcibly return the circulating fluid to the unit. Also, if you attach an external tank that is open to the air, it may become impossible to circulate the circulating fluid. Proceed with caution.



#### Electrical Wiring

##### **Warning**

1. Grounding should never be connected to a water line, gas line or lightning rod.

##### **Caution**

1. Communication cables should be prepared by the customer.
2. Ensure a stable power supply with no voltage surges and distortion.

In particular, operating failure can result when the voltage ramp rate ( $dV/dt$ ) exceeds 40 V/200  $\mu$  sec at the zero cross-over point.

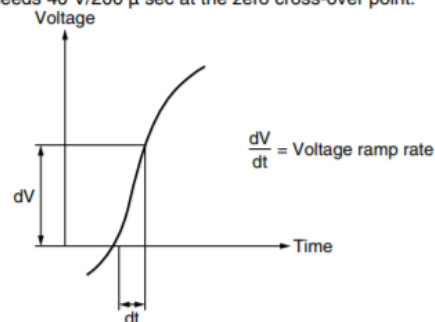

## HPLC Series

### Operational Display Panel HPLC-10/20

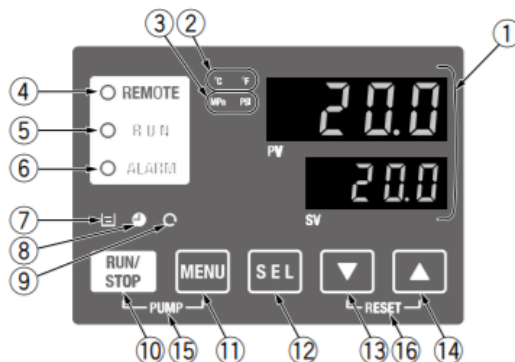

No.	Description	Function	
		PV	SV
①	<b>Digital display</b> (7-segment and 4 digits)	Displays the circulating fluid current discharge temperature and pressure and alarm codes and other menu items (codes).	Displays the circulating fluid discharge temperature and the set values of other menus.
②	<b>[°C] [°F] indicator</b>	Equipped with a unit conversion function. Displays the unit of display temperature (default setting: °C).	
③	<b>[MPa] [PSI] indicator</b>	Equipped with a unit conversion function. Displays the unit of display pressure (default setting: MPa).	
④	<b>[REMOTE] indicator</b>	Enables remote operation (start and stop) by communication. Lights up during remote operation.	
⑤	<b>[RUN] indicator</b>	Lights up when the product is started, and goes off when it is stopped. Flashes during stand-by for stop or anti-freezing function, or independent operation of the pump.	
⑥	<b>[ALARM] indicator</b>	Flashes with buzzer when alarm occurs.	
⑦	<b>[ ] indicator</b>	Lights up when the surface of the fluid level indicator falls below the L level.	
⑧	<b>[ ] indicator</b>	Equipped with a timer for start and stop. Lights up when this function is operated.	
⑨	<b>[ ] indicator</b>	Equipped with a power failure auto-restart function, which restarts the product automatically after stopped due to a power failure, is provided. Lights up when this function is operated.	
⑩	<b>[RUN/STOP] key</b>	Makes the product start or stop.	
⑪	<b>[MENU] key</b>	Shifts the main menu (display screen of circulating fluid discharge temperature and pressure) and other menus (for monitoring and entry of set values).	
⑫	<b>[SEL] key</b>	Changes the item in menu and enters the set value.	
⑬	<b>[▼] key</b>	Decreases the set value.	
⑭	<b>[▲] key</b>	Increases the set value.	
⑮	<b>[PUMP] key</b>	Press the [MENU] and [RUN/STOP] keys simultaneously. The pump starts running independently to make the product ready for start-up (release the air).	
⑯	<b>[RESET] key</b>	Press the [▼] and [▲] keys simultaneously. The alarm buzzer is stopped and the [ALARM] indicator is reset.	

### Alarm

This unit has 35 types of alarms as standard, and displays each of them by its alarm code on the PV screen with the [ALARM] lamp ([LOW LEVEL] lamp) lit up on the operation display panel. The alarm can be read out through communication.

Alarm code	Alarm message	Operation status	Alarm code	Alarm message	Operation status
AL01	Low level in tank	Stop *1	AL20	Memory error	Stop
AL02	High circulating fluid discharge temperature	Stop	AL21	DC line fuse cut	Stop
AL03	Circulating fluid discharge temperature rise	Continue *1	AL22	Circulating fluid discharge temperature sensor failure	Stop
AL04	Circulating fluid discharge temperature drop	Continue *1	AL23	Circulating fluid return temperature sensor failure	Stop
AL05	High circulating fluid return temperature (60°C)	Stop	AL24	Compressor intake temperature sensor failure	Stop
AL06	High circulating fluid discharge pressure	Stop	AL25	Circulating fluid discharge pressure sensor failure	Stop
AL07	Abnormal pump operation	Stop	AL26	Compressor discharge pressure sensor failure	Stop
AL08	Circulating fluid discharge pressure rise	Continue *1	AL27	Compressor intake pressure sensor failure	Stop
AL09	Circulating fluid discharge pressure drop	Continue *1	AL28	Pump maintenance	Continue
AL10	High compressor intake temperature	Stop	AL29	Fan motor maintenance *3	Continue
AL11	Low compressor intake temperature	Stop	AL30	Compressor maintenance	Continue
AL12	Low super heat temperature	Stop	AL31 *2	Contact 1 input signal detection	Stop *1
AL13	High compressor discharge pressure	Stop	AL32 *2	Contact 2 inputs signal detection	Stop *1
AL15	Refrigerating circuit pressure (high pressure side) drop	Stop	AL33 *4	Water leakage	Stop *1
AL16	Refrigerating circuit pressure (low pressure side) rise	Stop	AL34 *4	Electrical resistance rise	Continue
AL17	Refrigerating circuit pressure (low pressure side) drop	Stop	AL35 *4	Electrical resistance drop	Continue
AL18	Compressor overload	Stop	AL36 *4	Electrical resistance sensor failure	Continue
AL19 *2	Communication error *2	Continue *1			

\*1 "Stop" or "Continue" are default settings. Customers can change them to "Continue" and "Stop". For details, read the Operation Manual.

\*2 "AL19, AL31, AL32" are disabled in the default setting. If this function is necessary, it should be set by the customer referring to the Operation Manual.

\*3 For water-cooled models, the alarm is not activated.

\*4 This alarm function can be used when the option (sold separately) is used.

## HPLC Series

### Communication Function HPLC-10/20

#### Contact Input/Output

Item	Specifications	
Connector type (to the product)	MC 1,5/12-GF-3,5	
Input signal	Insulation method	Photocoupler
	Rated input voltage	24 VDC
	Operating voltage range	21.6 VDC to 26.4 VDC
	Rated input current	5 mA TYP
	Input impedance	4.7 kΩ
Contact output signal	Rated load voltage	48 VAC or less/30 VDC or less
	Maximum load current	500 mA AC/DC (resistance load)
Output voltage	24 VDC ± 10% 0.5 A Max	
Circuit diagram		

\* The pin numbers and output signals can be set by the customer. For details, refer to the Operation Manual.

#### Serial Communication

The serial communication (RS-485/RS-232C) enables the following items to be written and read out. For details, refer to the Operation Manual for communication.

##### Writing

Run/Stop  
Circulating fluid temperature setting (SV)

##### Readout

Circulating fluid present temperature (PV)  
Circulating fluid discharge pressure (SV)  
Electrical resistance \*1  
Status information  
Alarm occurrence information

\*1 When optional electrical resistance sensor set is used

Item	Specifications	
Connector type	D-sub 9-pin, Female connector	
Protocol	Modicon Modbus compliant/Simple communication protocol	
Standards	EIA standard RS-485	EIA standard RS-232C
Circuit diagram		