

WM30

Power analyzer for three-phase systems



Description

WM30 is a modular power analyzer for single-, two- and three-phase systems. It is made up of a maximum of four components: the main unit that displays measurements on the LCD display and manages 4 alarms, and three accessory modules, one with digital outputs, one with analogue outputs and the other for communication. The digital output module associates alarms with static or relay outputs and/or transmits pulses proportional to energy consumption. The analogue output module associates 0-20 mA or 0-10 V outputs to measured variables. The communication module allows you configure the analyzer and transmit data using a different communication protocol according to the version.

Main functions

- Measure main electrical variables and voltage and current harmonic distortions
- Measure active and reactive energy
- Measure load operating hours
- Manage up to 4 alarms
- Manage two digital outputs (via optional accessory module)
- Manage two analogue outputs (via optional accessory module)
- Transmit data to other systems (via optional accessory module)

Benefits

- **Clarity.** The wide backlit LCD display clearly shows the measurements and the configuration parameter values.
- **Simplicity.** An optical port is available for quick analyzer configuration using OptoProg (CARLO GAVAZZI).
- **Specific software.** WM30 can be configured and measurements viewed from UCS configuration software (CARLO GAVAZZI). The software and subsequent updates are free.
- **Scalability.** Three accessory modules can be added to WM30 according to need. This way, the analyzer extends its control capacities and communicates data remotely.
- **Communication flexibility.** The communication module is available in Modbus RTU, Modbus TCP/IP, BACnet IP, BACnet MS/TP and Profibus DP V0 versions.
- **Fast installation.** WM30 and accessory modules are all equipped with detachable terminals. Modules can be quickly installed via the specifically designed fast coupling pins.
- **Tamper-proof.** WM30 configuration access can be locked. Terminals and accessory modules can be sealed.

Applications

WM30 can be installed in any switchboard to control energy consumption, main electrical variables and harmonic distortion.

In automation, WM30 can use the communication module with Profibus protocol to both communicate data on consumption to supervision systems and manage them independently if installed on a machine.

In building, WM30 can be installed in existent architectures using the communication module with BACnet protocol (on RS485 or Ethernet).



Components

Module	Description
WM30	Main unit, measures and displays main electrical variables. With LCD display and touch keypad, it lets you set measurement parameters, configure accessory modules and manage up to 4 alarms.
Digital outputs (optional)	Accessory module with two digital outputs. Expands main unit capacity, specifically allowing you to: transmit pulses proportional to energy consumption control digital outputs (static or relay according to the module)
Analogue outputs (optional)	Accessory module with two analogue outputs. Expands main unit capacity, specifically allowing you to associate a 0-20mA or 0-10V output to a measured variable
Communication (optional)	Accessory module that lets you transmit data to other systems or configure the analyzer from remote

Compatible accessory modules

Type	Module description	Code
Digital outputs	Double static output	M O O2
	Double relay output	M O R2
Analogue outputs	Double analogue output (+20mA dc)	M O A2
	Double analogue output (+10V dc)	M O V2
Communication	Modbus RTU communication on RS485/RS232	M C 485232
	Modbus TCP/IP communication on Ethernet	M C ETH
	BACnet IP communication on Ethernet	M C BAC IP
	BACnet MS/TP communication on RS485	M C BAC MS
	Profibus DP V0 communication on RS485	M C PB

Possible configurations

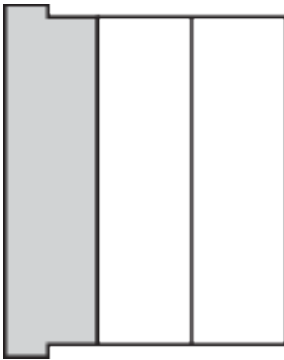
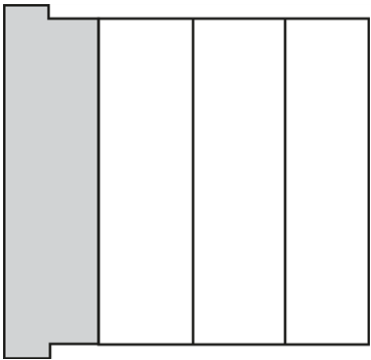
WM30only	WM30+ 1 module	WM30+ 2 modules	WM30+ 3 modules
			

NOTICE: maximum 1 module per type. In the configuration with 2 or 3 modules, the communication module is installed last.

Features

General features

Material	Front: ABS, self-extinguishing V-0 (UL 94) Back and accessory modules: PA66, self-extinguishing V-0 (UL 94)
Protection degree	Front: IP65 NEMA 4x NEMA 12 Terminals: IP20
Terminals	Type: detachable Section: 2.5 mm ² maximum Torque: 0.5 Nm
Overvoltage category	Cat. III
Pollution degree	2
Noise rejection (CMRR)	100 dB, from 42 to 62 Hz
Insulation	Double electrical insulation on areas accessible to the user. For insulation between inputs and outputs, see "Input and output insulation" below.

Input and output insulation

Note: test conditions: 4 kV rms ac for one minute.

Type	Power supply (H or L) [kV]	Measurement inputs [kV]	Digital outputs [kV]	Serial port [kV]	Ethernet port [kV]
Power supply (H or L)	-	4	4	4	4
Measurement inputs	4	-	4	4	4
Digital outputs	4	4	-	4	4
Serial port	4	4	4	-	NP
Ethernet port	4	4	4	NP	-

Key

- NP: combination not possible
- 4: 4 kV rms insulation (EN 61010-1, IEC 60664-1, overvoltage category III, pollution degree 2, double insulation on system with maximum 300 V rms to ground)

Environmental specifications

Operating temperature	From -25 to +55 °C/from -13 to +131 °F
Storage temperature	From -30 to +70 °C/from -22 to 158 °F

Note: R.H. < 90 % non-condensing @ 40 °C / 104 °F.

 **Conformity**

Directives	2014/35/EU (LVT - Low Voltage) 2014/30/EU (Electromagnetic Compatibility) 2011/65/EU, 2015/863/EU (Electric-electronic equipment hazardous substances)
Standards	Electromagnetic compatibility (EMC) - emissions and immunity: EN61000-6-3, EN61000-6-2 Electrical safety: EN 61010-1 Metrology: EN62053-22, EN62053-23 Pulse output: IEC 62053-31, DIN 43864
Approvals	

Main unit



Description

Main unit with LCD display and touch keypad to view measurements, configure the system and manage 4 alarms.

It can be integrated by digital output, analogue output and communication modules.

Four versions are available (AV4, AV5, AV6 and AV7) to manage different current and voltage inputs.

It can be quickly configured with OptoProg via optical port.

Main features

- System and phase variables (4 x 3 digits): V L-L, V L-N, A, W/var/VA, PF, Hz
- Active and reactive imported and exported energy meters (10 digits)
- Calculate the average and maximum system and phase values of all the electrical variables
- Calculate current and voltage THD (total harmonic distortions) up to the 32nd harmonic
- Calculate load operating hours
- Auxiliary power supply
- 4 virtual alarms
- Backlit LCD display and touch keypad
- Optical port
- Detachable terminals
- Sealable terminal caps
- Configuration via keypad or UCS configuration software (desktop or mobile Android App)
- Filter to stabilize displayed measurements

Main functions

- Measure main electrical variables and harmonic voltage and current distortions
- Measure active and reactive energy
- Measure load operating hours
- Manage up to 4 alarms

Structure

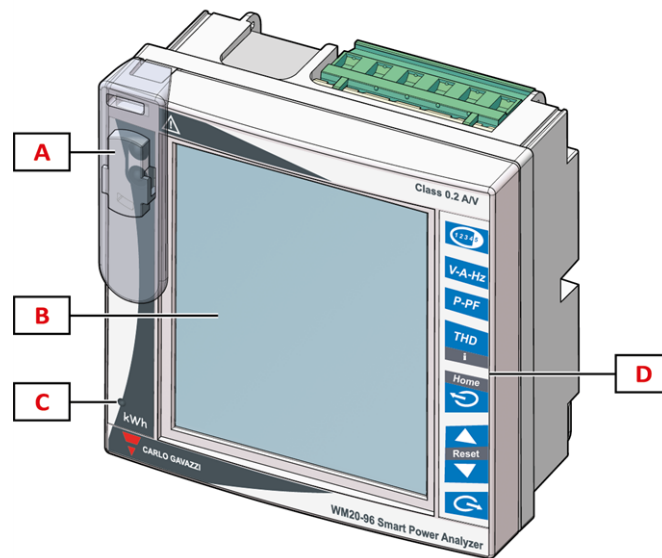

Fig. 1 Front

Element	Description
A	Optical port and plastic support for OptoProg (CARLO GAVAZZI) connection
B	Backlit LCD display
C	LED that blinks with frequency proportional to active energy consumption, see "LED" on page 14
D	Touch keypad

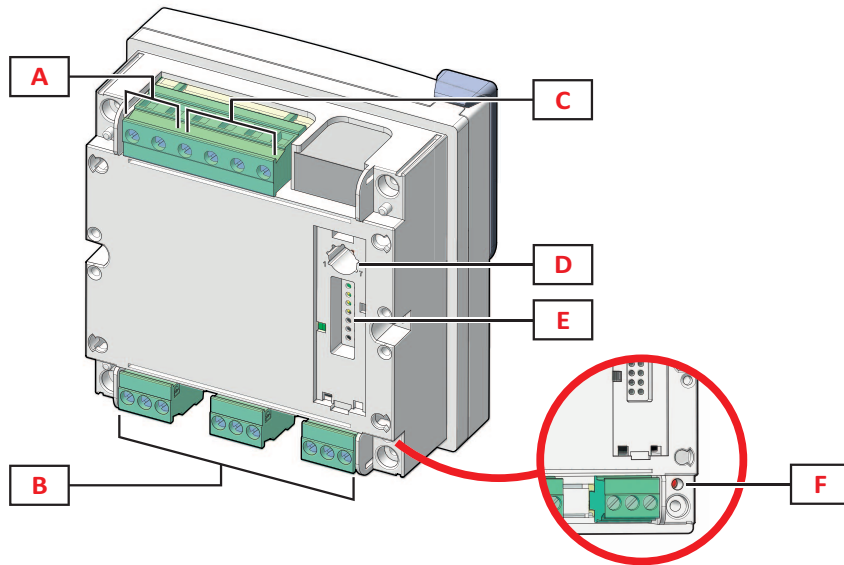

Fig. 2 Back

Element	Description
A	Detachable power supply terminals
B	Detachable current input terminals
C	Detachable voltage input terminals
D	Rotary selector to lock configuration
E	Local bus port for accessory modules
F	Power supply status LED, see "LED" on page 14

Features

General features

Assembly	Panel mounting
Weight	420 g (packaging included)

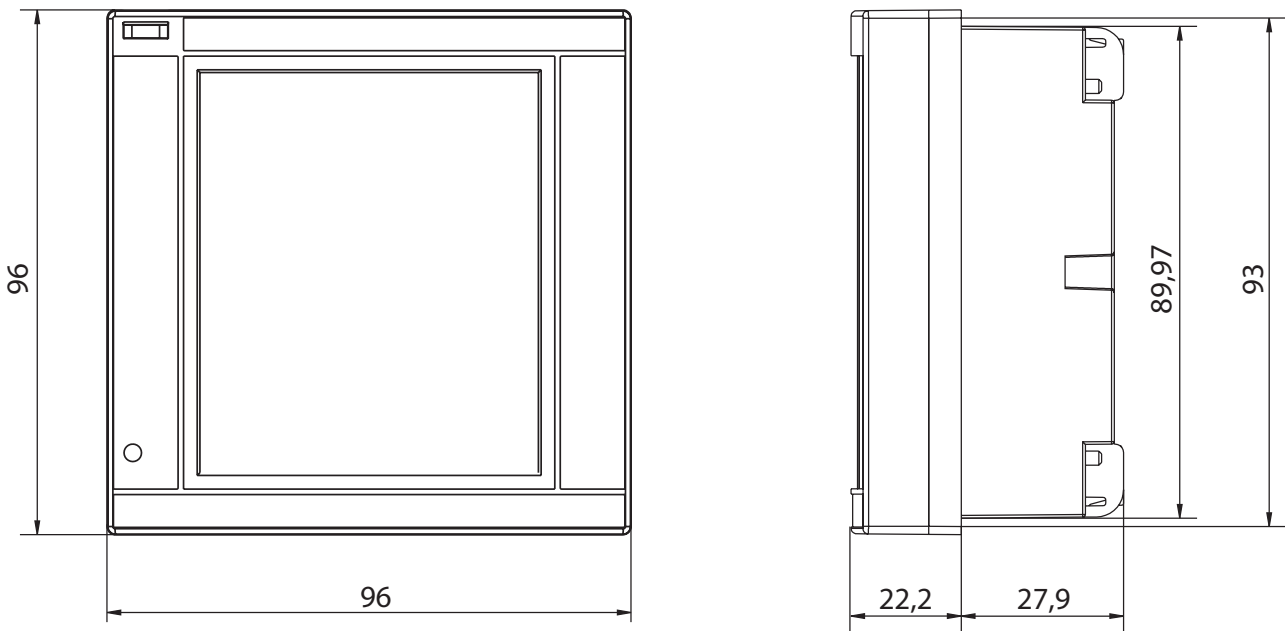

Electrical specifications

Electrical system	
Managed electrical system	Single-phase (2-wire) Two-phase (3-wire) Three-phase with neutral (4-wire) Three-phase without neutral (3-wire)

Voltage inputs				
Inputs	AV4	AV5	AV6	AV7
Voltage connection	Direct or via VT/PT			
VT/PT transformation ratio	From 1 to 9999			
Rated voltage L-N (from Un min to Un max)	From 220 to 400 V		From 57.7 to 133 V	

Voltage inputs		
Rated voltage L-L (from Un min to Un max)	From 380 to 690 V*	From 100 to 230 V
Voltage tolerance	-20%, + 15%	
Overload	Continuous: 1.2 Un max For 500 ms: 2 Un max	
Input impedance	>1.6 MΩ	
Frequency	From 40 to 440 Hz	

Note: *for UL applications max 600 VL-L, 40 °C (104 °F)

Current inputs				
Inputs	AV4	AV5	AV6	AV7
Current connection	Via CT			
CT transformation ratio	From 1 to 9999			
Rated current (In)	1 A	5 A		1 A
Minimum current (Imin)	0.01 A	0.05 A		0.01 A
Maximum current (Imax)	2 A	6 A		2 A
Start-up current (Ist)	1 mA	5 mA		1 mA
Overload	Continuous: Imax For 500 ms: 20 Imax			
Input impedance	< 0.2 VA			
Maximum CTxVT ratio	9999 x 9999			

Power supply

	H	L
Power supply	From 100 to 240 V ac/dc ± 10%	From 24 to 48 V ac/dc ± 15%
Consumption	10 W, 20 VA	

Measurements

Method	TRMS measurements of distorted waveforms
Sampling	3200 samples/s @50 Hz 3840 samples/s @60 Hz

 Available measurements

Active energy	Unit	System	Phase
Imported (+) Total	kWh+	•	-
Imported (+) partial	kWh+	•	-
Exported (+) Total	kWh-	•	-
Exported (+) partial	kWh-	•	-

Reactive energy	Unit	System	Phase
Imported (+) Total	kvarh+	•	-
Imported (+) partial	kvarh+	•	-
Exported (+) Total	kvarh-	•	-
Exported (+) partial	kvarh-	•	-

Electrical variable	Unit	System	Phase
Current	A	•	•
DMD	A	•	•
MAX	A	•	•
Neutral current	A	•	-
DMD	A	•	-
MAX	A	•	-
Voltage L-N	V	•	•
DMD	V	•	•
MAX	V	•	•
Voltage L-L	V	•	•
DMD	V	•	•
MAX	V	•	•
Asymmetry VLL	%	•	-
Asymmetry VLN	%	•	-
Active power	kW	•	•
DMD	kW	•	•
MAX	kW	•	•
Apparent power	kVA	•	•
DMD	kVA	•	•
MAX	kVA	•	•
Reactive power	kvar	•	•
DMD	kvar	•	•
MAX	kvar	•	•
Power factor	PF	•	•
DMD	PF	•	•

Electrical variable	Unit	System	Phase
MAX	PF	•	•
Frequency	Hz	•	-
DMD	Hz	•	-
MAX	Hz	•	-
THD Current*	THD A %	-	•
DMD	THD A %	-	•
MAX	THD A %	-	•
THD Voltage L-N*	THD L-N %	-	•
DMD	THD L-N %	-	•
MAX	THD L-N %	-	•
THD Voltage L-L*	THD L-L %	-	•
DMD	THD L-L %	-	•
MAX	THD L-L %	-	•
Run hour meter	h	•	-

* Up to 32nd harmonic

Note: the available variables depend on the type of system set.

Measurement mode

Depending on the APPLICATION setting, a different selection of variables is available on the display. The energy calculation is not affected and works always as bidirectional.

Energy metering

For every measuring interval time, the energies of the single phases are summed; according to the sign of the result, the positive (kWh+) or negative totalizer (kWh-) is increased.

Example:

P L1= +2 kW, P L2= +2 kW, P L3= -3 kW

Integration time = 1 hour

+kWh=(+2+2-3)x1h=(+1)x1h=1 kWh

-kWh=0 kWh

Measurement accuracy

Current	
From 0.05 In to I _{max}	±(0.2% rdg + 2dgt)
From 0.01 In to 0.05 In	±(0.5% rdg + 2dgt)

Phase-phase voltage	
From Un min -20% to Un max +15%	$\pm(0.2\% \text{ rdg} + 1 \text{ dgt})$

Phase-neutral voltage	
From Un min -20% to Un max +15%	$\pm(0.5\% \text{ rdg} + 1 \text{ dgt})$

Active and apparent power	
From 0.05 In to Imax (PF=0.5L, 1, 0.8C)	$\pm(0.5\% \text{ rdg} + 1 \text{ dgt})$
From 0.01 In to 0.05 In (PF=1)	$\pm(1\% \text{ rdg} + 1 \text{ dgt})$

Reactive power	
From 0.1 In to Imax (sin ϕ =0.5L, 0.5C) From 0.05 In to Imax (sin ϕ =1)	$\pm(1\% \text{ rdg} + 1 \text{ dgt})$
From 0.05 In to 0.1 In (sin ϕ =0.5L, 0.5C) From 0.02 In to 0.05 In (PF=1)	$\pm(1.5\% \text{ rdg} + 1 \text{ dgt})$
Power factor	$\pm[0.001+0.5\%(1 - \text{PF rdg})]$
Active energy	Class 0.5S (EN62053-22), class 0.5 (ANSI C12.20)
Reactive energy	Class 2 (EN62053-23, ANSI C12.1)
THD	$\pm 1\%$

Frequency	
From 45 to 65 Hz	$\pm(0.02\% \text{ rdg} + 1 \text{ dgt})$
From 65 to 340 Hz	$\pm(0.05\% \text{ rdg} + 1 \text{ dgt})$
From 340 to 440 Hz	$\pm(0.1\% \text{ rdg} + 1 \text{ dgt})$

Display

Type	Backlit LCD
Refresh time	250 ms
Description	5 rows: • 1st: 10 digits (6 mm) • 2nd, 3rd, 4th, 5th: 4 digits (9.5 mm)
Variable readout	Instantaneous: 4 digits, min: 0.001, max: 9 999 Energy: 10 digits, min: 0.01, max: 9 999 999 999

 LED

Front	Red (kWh). Weight: proportional to energy consumption and depending on the CT and VT/ PT ratio product (16 Hz maximum frequency):	
	Weight (kWh per pulse)	CT*VT/PT
	0.001	≤ 7
	0.01	From 7.1 to 70
	0.1	From 70.1 to 700
	1	From 700.1 to 7000
	10	From 7001 to 70 k
	100	> 70.01 k
	Red (AL1, AL2, AL3, AL4). Alarm status.	
Back	Green. Power supply status.	

 Special functions

- 4 virtual alarms (up, down, in or out alarm)
- Filter to stabilize variable measurements with high fluctuations
- Load operating hour meter
- Clock
- Total active and reactive energy meters and average, minimum, max dmd and maximum values reset
- Optical port for configuration via OptoProg
- Password protected settings menu

Connection Diagrams

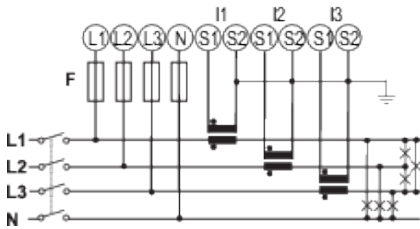

Fig. 3 Three-phase system with neutral (4-wire, 3P.n), unbalanced load and 3 CT. 315 mA fuse (F).

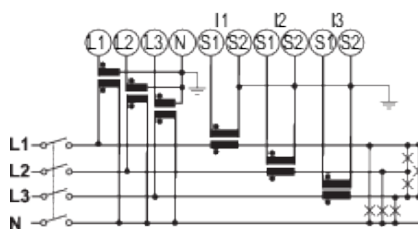

Fig. 4 Three-phase system with neutral (4-wire, 3P.n), unbalanced load, 3 CT and 3 VT/PT.

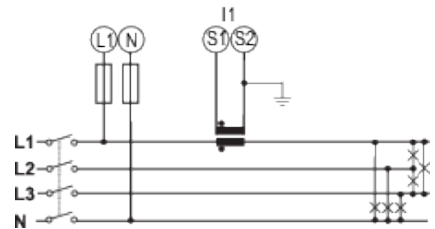

Fig. 5 Three-phase system with neutral (4-wire, 3P.2), balanced load, 1 CT. 315 mA fuse (F).

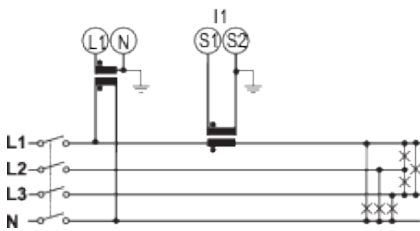

Fig. 6 Three-phase system with neutral (4-wire, 3P.2), balanced load, 1 CT and 1 VT/PT.

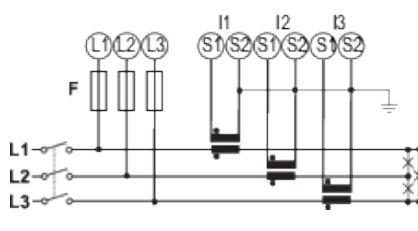

Fig. 7 Three-phase system without neutral (3-wire, 3P), unbalanced load and 3 CT. 315 mA fuse (F).

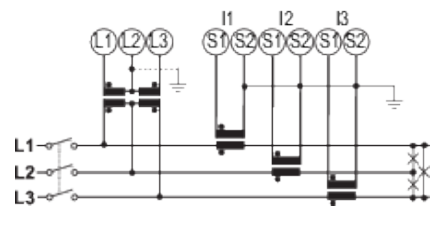

Fig. 8 Three-phase system without neutral (3-wire, 3P), unbalanced load, 3 CT and 2 VT/PT.

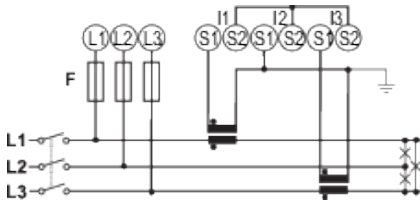

Fig. 9 Three-phase system without neutral (3-wire, 3P) unbalanced load and 2 CT (Aron). 315 mA fuse (F).

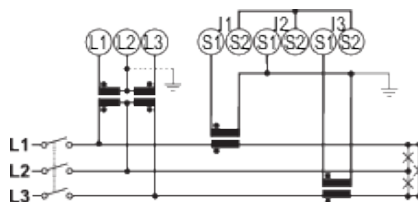

Fig. 10 Three-phase system without neutral (3-wire, 3P), unbalanced load, 2 CT (Aron) and 2 VT/PT.

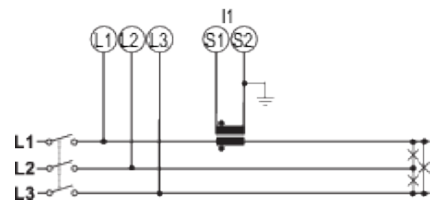

Fig. 11 Three-phase system without neutral (3-wire, 3P.1), balanced load, 1 CT.

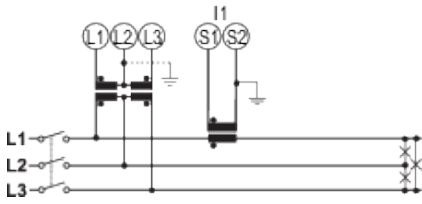

Fig. 12 Three-phase system without neutral (3-wire, 3P.1), balanced load, 1 CT and 2 VT/PT.

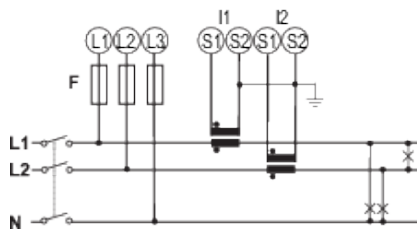

Fig. 13 Two-phase system (3-wire, 2P), 2 CT, 315 mA fuse (F).

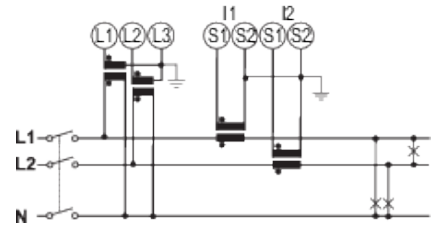

Fig. 14 Two-phase system (3-wire, 2P), 2 CT and 2 VT/PT.

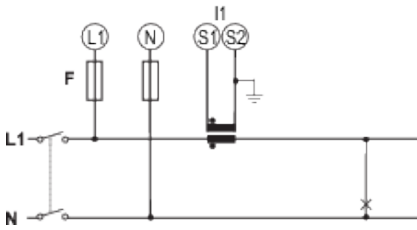

Fig. 15 Single-phase system (2-wire, 1P), 1 CT, 315 mA fuse (F).

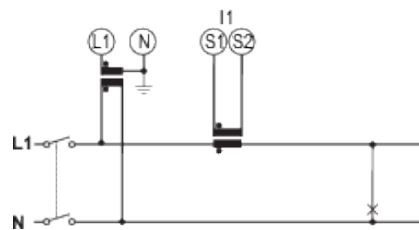

Fig. 16 Single-phase system (2-wire, 1P), 1 CT and 1 VT/PT.

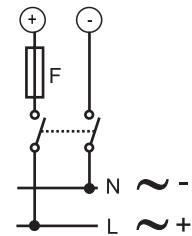

Fig. 17 Auxiliary power supply (H). 250 V [T] 630 mA fuse (F).
Auxiliary power supply (L). 250 V [T] 3.15 A fuse (F).

References

 WM30 AV 3 (9 characters total)

Enter the code option instead of

Code	Options	Description
W	-	-
M	-	-
3	-	-
0	-	-
A	-	-
V	-	-
<input type="checkbox"/>	4	From 380 to 690 V L-L ac, 1(2) A, connection via CT
	5	From 380 to 690 V L-L ac, 5(6) A, connection via CT
	6	From 100 to 230 V L-L ac, 5(6) A, connection via CT
	7	From 100 to 230 V L-L ac, 1(2) A, connection via CT
3	-	-
<input type="checkbox"/>	H	auxiliary power supply from 100 to 240 V ac/dc
	L	auxiliary power supply from 24 to 48 V ac/dc

Further reading

Information	Document	Where to find it
Instruction manual	Instruction manual - WM30	www.productselection.net

 **CARLO GAVAZZI compatible components**

Purpose	Component name/-code	Notes
Current measurement accessories	CTD1X, CTD2X, CTD3X, CTD4X	Solid core current transformers (1 or 5 A secondary current, 40 to 1600 A primary current) for cable or bus bar. See relevant datasheets.
	CTD1Z	Solid core current transformers (5 A secondary current, 50 to 200 A primary current) for cable or bus bar. See relevant datasheets.
	CTA5, CTA6	Split core current transformers for retrofit applications (5 A secondary current, 100 to 600 A primary current) for cable or bus bar. See relevant datasheets.
	CTD5S, CTD6S, CTD8S, CTD9S, CTD10S	Split core current transformers (1 or 5 A secondary current, 100 to 3200 A primary current) for bus bar. See relevant datasheets.
	CTD8V, CTD8V, CTD9V, CTD9H, CTD10V, CTD10H	Solid core current transformers (1 or 5 A secondary current, 150 to 3200 A primary current) for bus bar. See relevant datasheets.
	CTD8Q	Solid core current transformers (5 A secondary current, 1000 to 4000 A primary current) for bus bar. See relevant datasheets.
Manage two digital outputs/associate alarms to digital outputs	M O O2 M O R2	See "Digital output modules" on page 19
Manage two analogue outputs	M O A2 M O V2	See "Analogue output modules" on page 25
Transmit data remotely	M C 485232 M C ETH M C BAC IP M C BAC M C PB	See
Configure analyzer via desktop application	UCS configuration software	Available for free download at: www.productselection.net
Configure analyzer via Mobile Android App	UCS Mobile Android App	Available for free download at: Google Play Store 
Monitor data from several analyzers	UWP3.0	See relevant datasheet
Quickly configure several analyzers via optical interface	OptoProg	See relevant datasheet
RS485/USB conversion	SIU-PC3	See relevant datasheet

Digital output modules



Description

Accessory module for WM analyzer family that associates static or relay outputs to alarms and/or transmits pulses proportional to energy consumption. Each output can run three different functions: alarm, remote control or pulse.

Main features

- Two digital outputs (static or relay)
- Three possible functions for each output
- Configuration via main unit keypad or UCS configuration software
- Easy mounting on main unit
- Detachable terminals
- Local bus connection to main unit

Main functions

- Manage two static or relay outputs
- Associate static or relay outputs with alarms
- Transmit pulses proportional to energy consumption

Structure

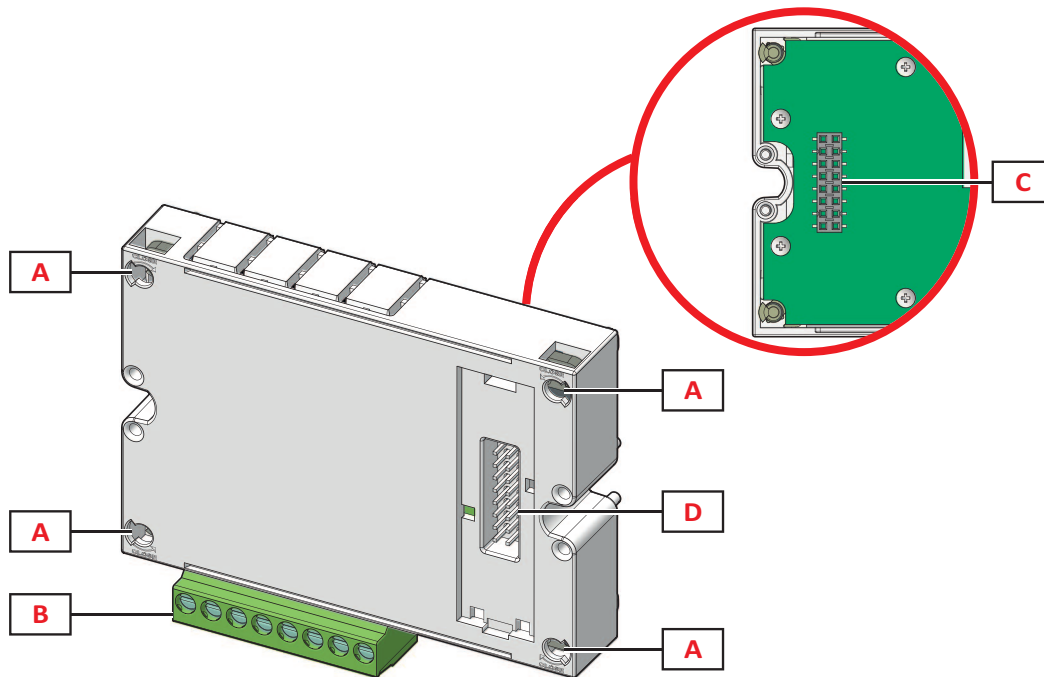

Fig. 18 Front

Element	Description
A	Main unit fastening pins
B	Detachable digital output terminals
C	Local bus port for main unit
D	Local bus port for communication module

▶ Digital output functions

Digital outputs can run three different functions:

- Alarm: output associated with an alarm and directly managed by WM30
- Remote control: output status managed via communication
- Pulse: pulse transmission output on active or reactive, imported or exported energy consumption.

Features

General

Mounting	On main unit
Weight	80g
Power supply	Self power supply via local bus

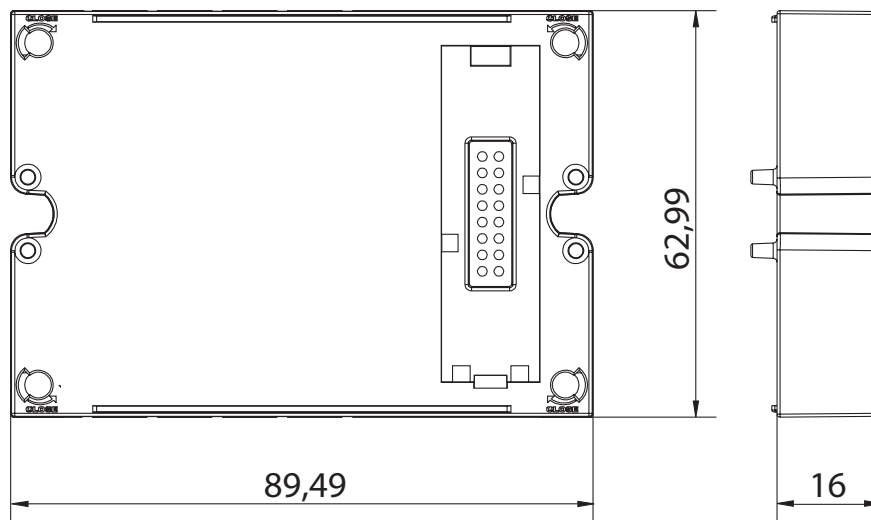

Static output module (M O O2)

Maximum number of outputs	2
Type	Opto-mosfet
Features	V_{ON} : 2.5 V dc, 100 mA max V_{OFF} : 42 V dc max
Configuration parameters	Output function: alarm/remote control/pulse Associated output alarm and normal status ("alarm" function only) Pulse weight, transmitted energy type, test transmission settings ("pulse" function only)
Configuration mode	Via keypad or UCS software

Relay output module (M O R2)

Maximum number of outputs	2
Type	SPDT relay

Features	AC1: 5 A @ 250 V ac AC15: 1 A @250 V ac
Configuration parameters	Output function: alarm/remote control/pulse Associated output alarm and normal status ("alarm" function only) Pulse weight, transmitted energy type, test transmission settings ("pulse" function only)
Configuration mode	Via keypad or UCS software

Connection Diagrams

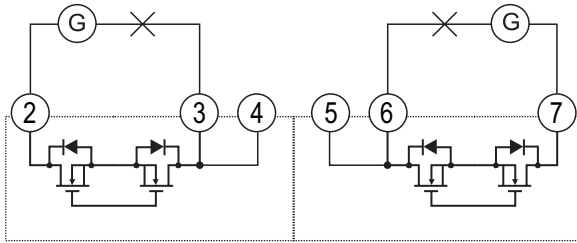

Fig. 19 M O O2. Double static opto-mosfet output.

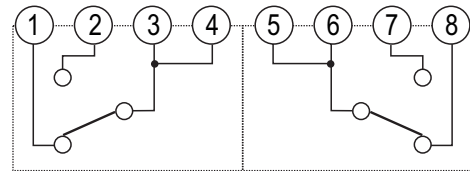

Fig. 20 M O R2. Double relay output.

References

Order code

Code	Description
M O O2	Double static output
M O R2	Double relay output

Further reading

Information	Document	Where to find it
Instruction manual - WM30	Instruction manual - WM30	www.productselection.net
Digital output module instruction manual		

CARLO GAVAZZI compatible components

Purpose	Component name/-code	Notes
Power the module via analyzer	WM20 WM30 WM40	The digital output module only works connected to an analyzer. See relevant datasheets.

Analogue output modules



Description

Accessory module for WM analyzer family that associates analogue outputs to electrical variables.
Depending on the version the output range can be set between 0 and 20 mA or 0 and 10 V dc.

Main features

- Two analogue outputs (0 to 20 mA or 0 to 10V)
- Configuration via main unit keypad or UCS configuration software
- Easy mounting on main unit
- Detachable terminals
- Local bus connection to main unit

Main functions

- Associate electrical variables to analogue outputs.

Structure

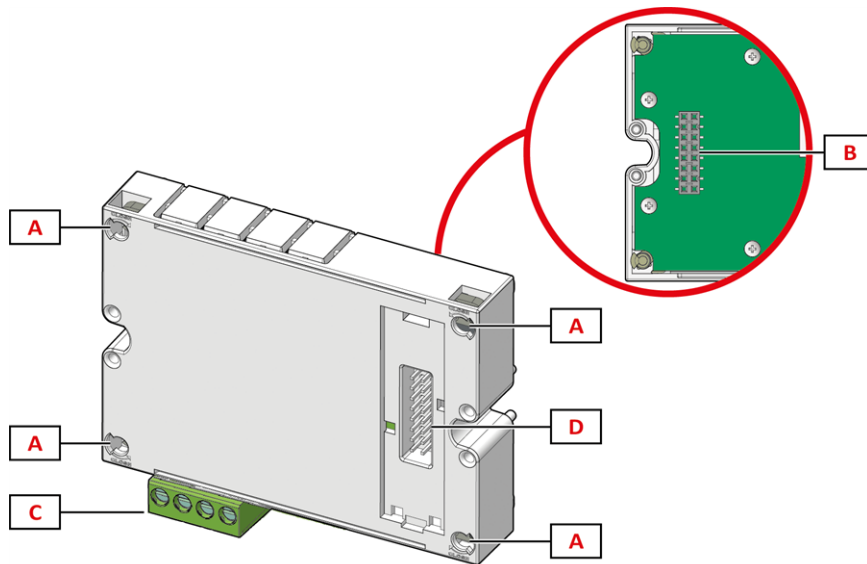

Fig. 21 Front

Element	Description
A	Main unit fastening pins
B	Local bus port for main unit
C	Analogue outputs
D	Local bus port for communication module

▶ Analogue output functions

Analogue outputs can be linked to any electrical variables.

Features

General

Mounting	On main unit
Weight	80g
Power supply	Self power supply via local bus

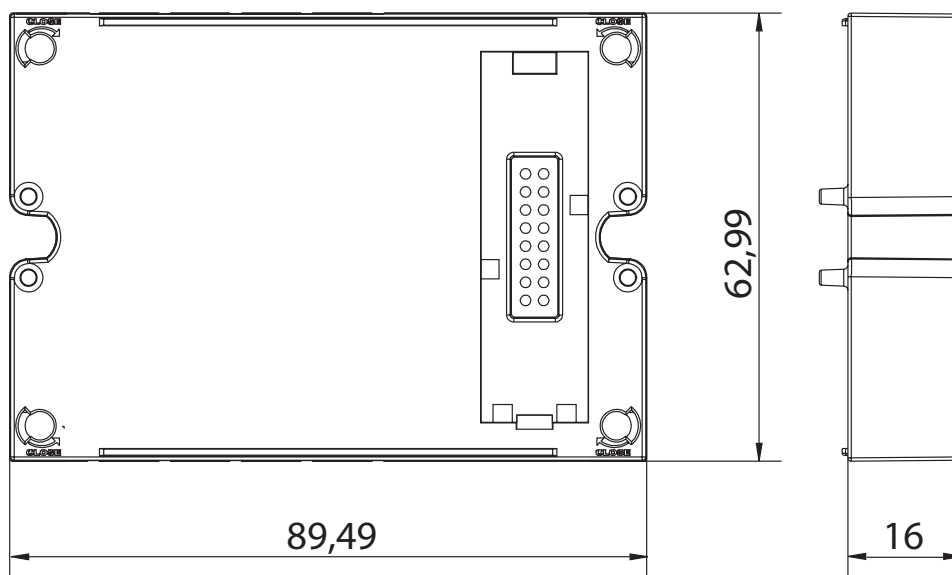

Analogue output module 0-20mA (M O A2)

Maximum number of outputs	2
Type	0 to 20 mA dc
Accuracy	0.2% FS
Features	Response time ≤ 400 ms typical (filter excluded) Ripple $\leq 1\%$ (according to IEC 60688-1, EN 60688-1) Total temperature drift ≤ 500 ppm/ $^{\circ}$ C Load $\leq 600\Omega$
Configuration parameters	Associated electrical variable. Min analogue output (as a percentage of 20mA) Max analogue output (as a percentage of 20mA) Electrical variable value corresponding to min output. Electrical variable value corresponding to max output.
Configuration mode	Via keypad or UCS software

Analogue output module 0-10V (M O V2)

Maximum number of outputs	2
Type	0 to 10 V dc
Accuracy	0.2% FS
Features	Response time ≤ 400 ms typical (filter excluded) Ripple $\leq 1\%$ (according to IEC 60688-1, EN 60688-1) Total temperature drift ≤ 350 ppm/ $^{\circ}$ C Load ≥ 10 k Ω
Configuration parameters	Associated electrical variable. Min analogue output (as a percentage of 10 V) Max analogue output (as a percentage of 10 V) Electrical variable value corresponding to min output. Electrical variable value corresponding to max output.
Configuration mode	Via keypad or UCS software

Connection Diagrams

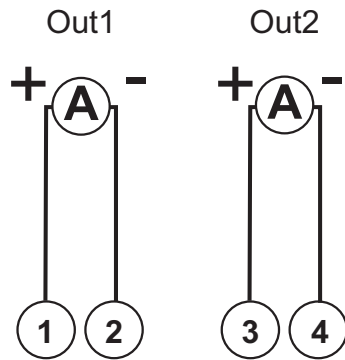

Fig. 22 MO A2. Double analogue output 0-20mA.

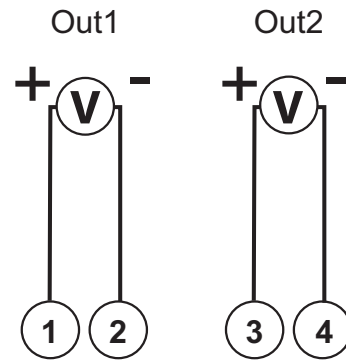

Fig. 23 MO V2. Double analogue output 0-10V.

References

▶ Order code

Code	Module description
M O A2	Double analogue output 0-20mA.
M O V2	Double analogue output 0-10V.

▶ Further reading

Information	Document	Where to find it
WM30 instruction manual	Instruction manual - WM30	www.productselection.net
Analogue output module instruction manual		

▶ CARLO GAVAZZI compatible components

Purpose	Component name/-code	Notes
Power the module via analyzer	WM20 WM30 WM40	The digital output module only works connected to an analyzer. See relevant datasheets.

Communication modules



Description

Accessory module for WM analyzer family connected to the main unit that transmits system data remotely using a different communication protocol according to the version.

Main features

- Supported communication protocols: Modbus, BACnet, Profibus. See "Communication module overview " on page 21
- Configuration via main unit keypad or UCS configuration software
- Easy mounting on main unit
- Local bus connection to main unit

Main functions

- Transmit data remotely
- Configure the system

Communication module overview

Module code	Communication protocols	Port
M C 485232	Modbus RTU	RS485, RS232
M C ETH	Modbus TCP/IP	Ethernet
M C BAC IP	BACnet IP, Modbus TCP/IP	Ethernet
M C BAC MS	BACnet MS/TP	RS485
	Modbus TCP/IP	Ethernet
M C PB	Profibus DP V0 slave	RS485
	Modbus RTU	micro USB

Structure

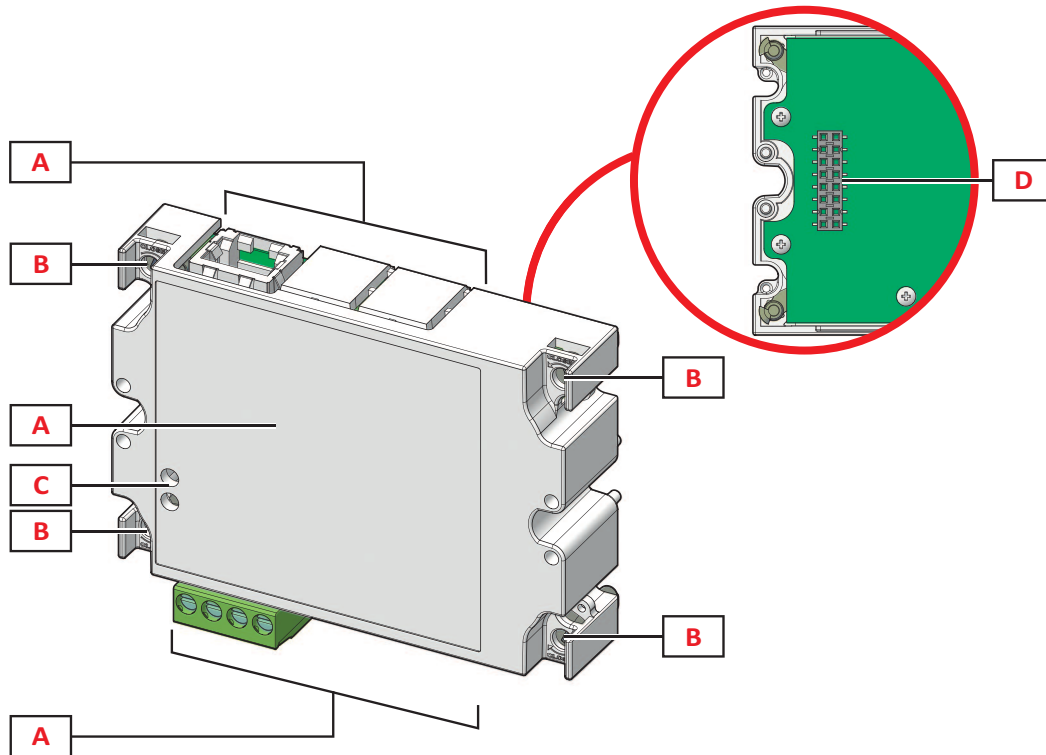

Fig. 24 Front

Note: NOTE: the image refers to the M C BAC MS module.

Area	Description
A	Communication port area Note: the communication ports depend on the communication module, see "Communication module overview" on the previous page
B	Main unit fastening pins
C	Communication status LED (M C 485232, M C BAC MS, M C PB)
D	Local bus port for main unit or digital output module

Features

General

Mounting	On main unit (with or without digital output module)
Power supply	Self power supply via local bus
Weight	80g

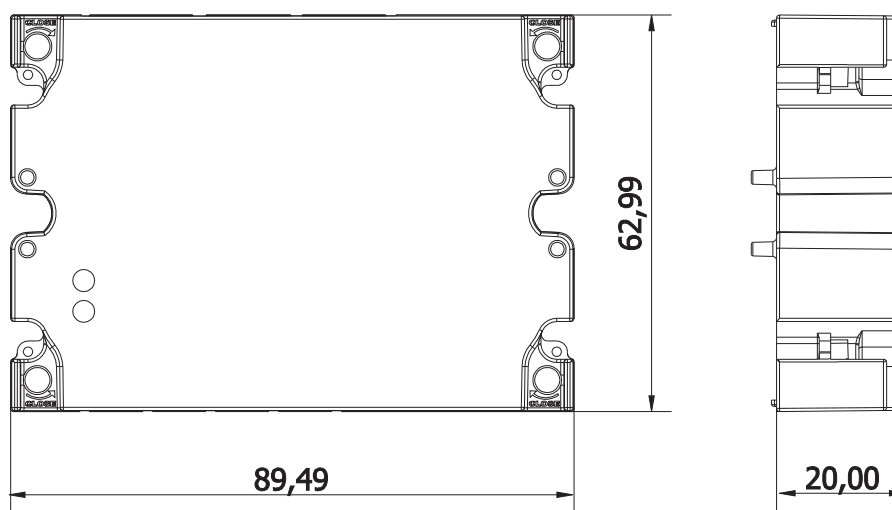

M C 485232 module

RS485 port

Protocols	Modbus RTU
Devices on the same bus	Max 160 (1/5 unit load)
Communication type	Multidrop, bidirectional
Connection type	2 wires, maximum distance 1000 m
Configuration parameters	Modbus address (from 1 to 247) Baud rate (9,6/ 19,2/ 38,4/ 115,2 kbps) Parity (None/ Odd/ Even)
Configuration mode	Via keypad or UCS software

RS232 port

Protocols	Modbus RTU
Communication type	Bidirectional
Connection type	3 wires, maximum distance 15 m

Configuration parameters	Modbus address (from 1 to 247) Baud rate (9,6/ 19,2/ 38,4/ 115,2 kbps) Parity (None/ Odd/ Even)
Configuration mode	Via keypad or UCS software

Note: the RS485 and RS232 ports are alternative.

LED

Meaning	Communication status: Yellow: receiving Green: transmitting
----------------	-------------------------------------------------------------------

M C ETH module

Ethernet port

Protocols	Modbus TCP/IP
Client connections	Maximum 5 simultaneously
Connection type	RJ45 connector (10 Base-T, 100 Base-TX), maximum distance 100 m
Configuration parameters	IP address Subnet mask Gateway TCP/IP port
Configuration mode	Via keypad or UCS software

M C BAC IP module

Ethernet port	
Protocols	BACnet IP (reading) Modbus TCP/IP (reading and configuration)
Client connections	(Modbus only) Maximum 5 simultaneously
Connection type	RJ45 connector (10 Base-T, 100 Base-TX), maximum distance 100 m
Configuration parameters	<p>BACnet IP protocol:</p> <ul style="list-style-type: none"> • Instance number (from 0 to 9999 via keypad, from 0 to 4194302 via communication) • Foreign Device enabling • BBMD address • UDP port • WM30 time-to-live recording as Foreign Device on specified BBMD server <p>Modbus TCP/IP protocol:</p> <ul style="list-style-type: none"> • IP address • Subnet mask • Gateway • TCP/IP port

Ethernet port	
Supported services	"I-have", "I-am", "Who-has", "Who-is", "Read-property (multiple)"
Supported objects	Type 2 (analogue value including COV property), type 5 (binary value, for alarm transmission), type 8 (device)
Configuration mode	Via keypad or UCS software

M C BAC MS module

RS485 port

Protocols	BACnet MS/TP (measurement reading and object description writing)
Communication type	Multidrop, monodirectional
Connection type	2 wires, maximum distance 1000 m
Supported services	"I-have", "I-am", "Who-has", "Who-is", "Read-property (multiple)"
Supported objects	Type 2 (analogue value including COV property), type 5 (binary value, for alarm transmission), type 8 (device)
Configuration parameters	BACnet IP protocol: <ul style="list-style-type: none"> • Instance number (from 0 to 9999 via keypad, from 0 to 4194302 via communication) • Baud rate (9,6/ 19,2/ 38,4/ 57,6/ 76,8 kbps) • MAC address (from 0 to 127)
Configuration mode	Via keypad or UCS software

Ethernet port

Protocols	Modbus TCP/IP (configuration)
Client connections	(Modbus only) Maximum 5 simultaneously
Connection type	RJ45 connector (10 Base-T, 100 Base-TX), maximum distance 100 m
Configuration parameters	IP address Subnet mask Gateway TCP/IP port
Configuration mode	Via keypad or UCS software

LED

Meaning	Communication status: Yellow: receiving Green: transmitting
----------------	-------------------------------------------------------------------

M C PB module

Profibus port

Protocols	Profibus DP V0 slave
Connection type	9-pin D-sub receptacle RS485

Configuration parameters	Address, via keypad Other settings with UCS software via serial communication
Configuration mode	Via keypad or UCS software

Micro-USB port

Protocols	Modbus RTU
Type	USB 2.0 (USB 3.0 compatible)
Connection type	Micro-USB B
Baud rate	Any (maximum 115.2 kbps)
Address	1

LED

Meaning	Communication status: Red: between module and main unit Green: between module and Profibus master
----------------	---------------------------------------------------------------------------------------------------------

Connection Diagrams

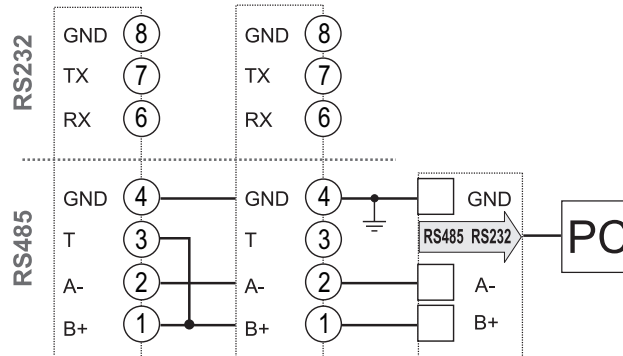

Fig. 25 M C 485232. RS485 serial port.

Note: additional meters with RS485 are connected in daisy chain. The serial output must only be terminated on the last network meter connecting terminals B+ and T.

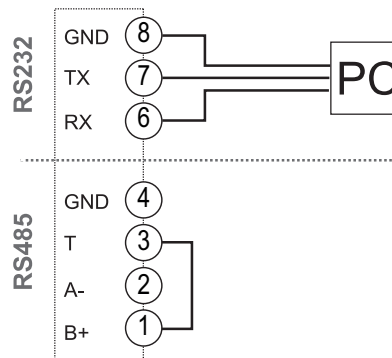

Fig. 26 M C 485232. RS232 serial port.

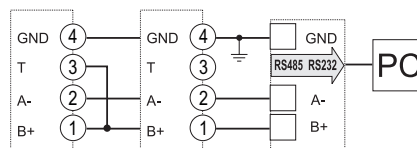

Fig. 27 M C BAC MS. RS485 serial port.

Note: additional meters with RS485 are connected in daisy chain. The serial output must only be terminated on the last network meter connecting terminals B+ and T.

References

Order code

Code	Module description
MC 485232	Modbus RTU communication on RS485/RS232
MC ETH	Modbus TCP/IP communication on Ethernet
MC BAC IP	BACnet IP communication on Ethernet
MC BAC MS	BACnet MS/TP communication on RS485
MC PB	Profibus DP V0 communication on RS485

Further reading

Information	Document	Where to find it
WM30 instruction manual	Instruction manual - WM30	www.productselection.net
Communication module instruction manual (M C 485232, M C ETH, M C BAC IP, M C BAC MS)		
Communication module instruction manual (M C PB)		

CARLO GAVAZZI compatible components

Purpose	Component name/-code	Notes
Power the module via analyzer	WM20 WM30 WM40	The communication module only works connected to an analyzer. See relevant datasheets.



COPYRIGHT ©2022

Content subject to change. Download the PDF: www.gavazziautomation.com