

WJ2EDGVC-5.0/5.08  
PLUG-IN TERMINAL BLOCK



PCB connector  
Rated current: 15 A  
Rated voltage: 300 V  
Pitch: 5.0 mm/5.08 mm  
Mounting: Wave soldering



UL/CUL

Use Group	B	C	D
Rate Voltage [V]	300	-	300
Rated Current [A]	15	-	10
Wire Range [AWG]	/		
Dielectric Voltage-Withstand	1.6KV		

IEC

Overvoltage Category	III	III	II
Contamination Class	3	2	2
Rated Voltage [V]	250	320	630
Rated Current [A]	15	15	15
Impulse withstand voltage [KV]	4	4	4
Conductor cross section[solid/flexible] [mm <sup>2</sup> ]	/		

Material

Insulation Material	PA66
---------------------	------

Flame retardant rating	UL94V-0
Conductor Material	Copper alloy
Plating of conductor surface	Sn plated

**Other Data**

Pitch/Poles [mm]/[P]	5.0 , 5.08/2-24
Stripping Length [mm]	/
Screw/Torque(Max)[N.m]	
Operating temperature [°C]	-40~+105
Soldering temperature	260°C/5S
Pin dimensions [mm]	1.0*1.0
PCB Hole Diameter [mm]	□1.7

**Dimensions**

**PCB opening diagram**

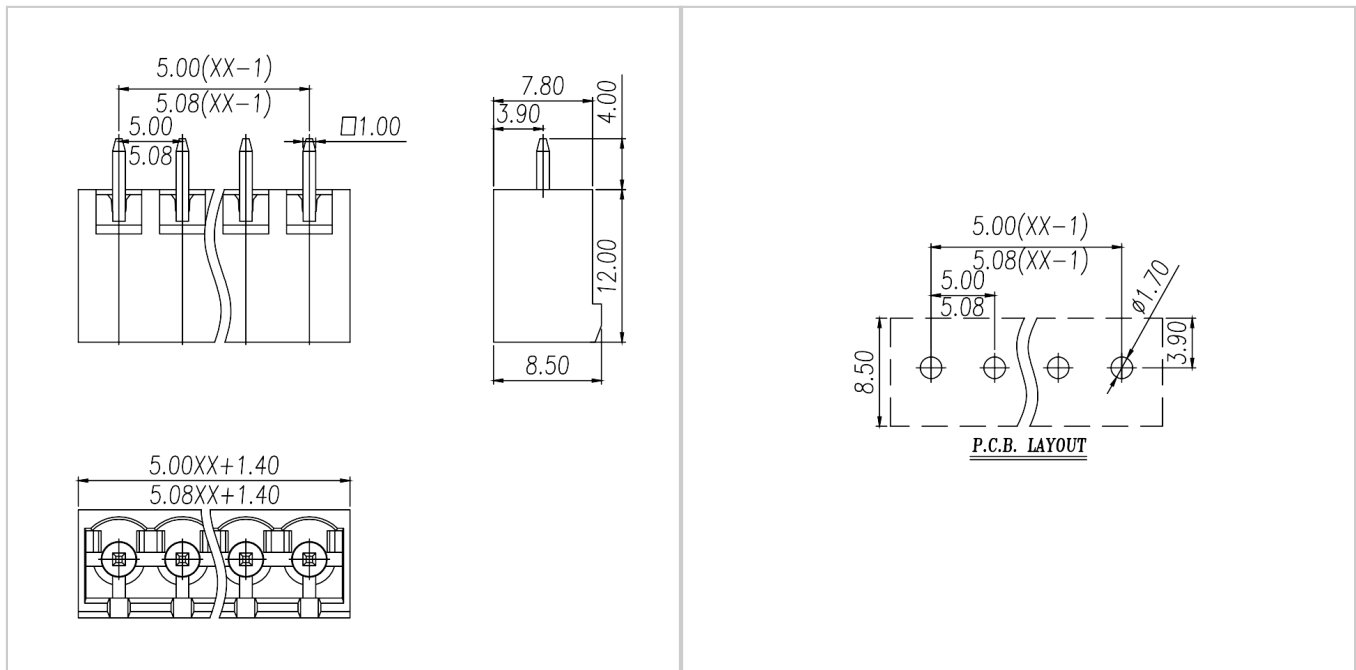

**Accessories**