

WJ2EDGKR-7.62
PLUG-IN TERMINAL BLOCK



PCB connector
Rated current: 15 A
Rated voltage: 300 V
Wire range: 28-12 AWG
Pitch: 7.5 mm



UL/CUL

Use Group	B	C	D
Rate Voltage [V]	300	-	300
Rated Current [A]	15	-	10
Wire Range [AWG]	28-12		
Dielectric Voltage-Withstand	1.6KV		

IEC

Overvoltage Category	III	III	II
Contamination Class	3	2	2
Rated Voltage [V]	400	630	1000
Rated Current [A]	12	12	12
Impulse withstand voltage [KV]	6	6	6
Conductor cross section[solid/flexible] [mm ²]	0.2-2.5		

Material

Insulation Material	PA66
---------------------	------

WJ2EDGKR-7.62
PLUG-IN TERMINAL BLOCK

Flame retardant rating	UL94V-0
Conductor Material	Copper alloy
Plating of conductor surface	Sn plated

Other Data

Pitch/Poles [mm]/[P]	7.5/2-24
Stripping Length [mm]	7-8
Screw/Torque(Max)[N.m]	
Operating temperature [°C]	-40~+105
Soldering temperature	/
Pin dimensions [mm]	/
PCB Hole Diameter [mm]	/

Dimensions

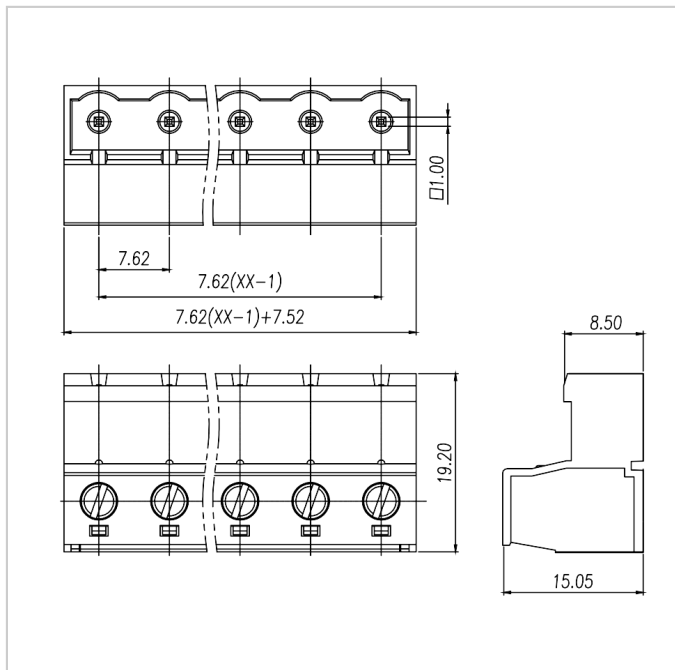

Accessories