

SPECIFICATION

Part No. : **WCM.01.0151**

Product Name: : 2.4GHz Button Antenna

Features : Tiny Size – 19.8mm*14.3mm*16.4mm
2400MHz to 2500MHz Antenna
Wi-Fi / Bluetooth
60%+ Efficiency
RP SMA(M) Connector
IP67
Omnidirectional
ROHS Compliant

Photo:



1. Introduction

The WCM.01 2.4GHz antenna is the smallest RP-SMA(M) external antenna in the market, fitting into spaces no other traditional monopole, dipole or rubber ducky antenna can go. A unique PIFA design ensures omnidirectional gain across 2.4GHz to 2.5GHz ensuring constant reception and transmission to make it a great Wi-Fi antenna for 2.4GHz Wi-Fi and Bluetooth applications.

This antenna features greater than 60% efficiency when connected directly to the ground plane of the device.

Typical Applications

- Application Points
- Routers
- IoT M2M devices
- Smart home applications

This antenna comes with a RP SMA(M) to be compatible with most Wi-Fi applications and routers in the market. The WCM.01 antenna is also IP67 water resistant. The ideal position for the antenna to radiate is mounted clear of metal. Connector is customizable.

Contact Taoglas regional sales office for more information.

2. Specification

ELECTRICAL				
Frequency (MHz)		2400	2450	2500
Efficiency (%)				
In free space		33.30	30.36	29.65
On the 10*10cm	Ground plane(center)	63.43	71.44	66.85
	Ground plane(edge)	55.85	68.43	61.73
On the 20*20cm	Ground plane(center)	64.20	71.40	63.97
	Ground plane(edge)	62.55	81.30	69.73
On the 30*30cm	Ground plane(center)	58.31	70.49	60.87
	Ground plane(edge)	62.11	73.46	61.90
Average gain (dBi)				
In free space		-4.78	-5.18	-5.28
On the 10*10cm	Ground plane(center)	-1.98	-1.46	-1.75
	Ground plane(edge)	-2.53	-1.65	-2.10
On the 20*20cm	Ground plane(center)	-1.92	-1.46	-1.94
	Ground plane(edge)	-2.04	-0.90	-1.57
On the 30*30cm	Ground plane(center)	-2.34	-1.52	-2.16
	Ground plane(edge)	-2.07	-1.34	-2.08
Peak gain (dBi)				
In free space		0.89	0.40	0.12
On the 10*10cm	Ground plane(center)	2.02	2.45	2.37
On the 10*10cm	Ground plane(edge)	3.46	4.09	3.47
On the 20*20cm	Ground plane(center)	4.26	4.54	3.69
On the 20*20cm	Ground plane(edge)	4.02	5.40	4.65
On the 30*30cm	Ground plane(center)	3.64	4.85	4.06
On the 30*30cm	Ground plane(edge)	3.79	4.23	3.15
Radiation	Omnidirectional			
Polarization	Linear			
Impedance	50 Ω			
Input Power	10W			
MECHANICAL				
Antenna Dimension	19.8*14.3*16.4mm			
Casing	ABS			
Connector	RP-SMA(M)			
Weight	6g			
Ingress Protection Rating	IP67			

ENVIRONMENTAL	
Operation Temperature	-40°C ~ + 85°C
Storage Temperature	-40°C ~ + 85°C
Humidity	Non-condensing 65°C 95% RH

3. Antenna Characteristics

3.1 Testing Setup

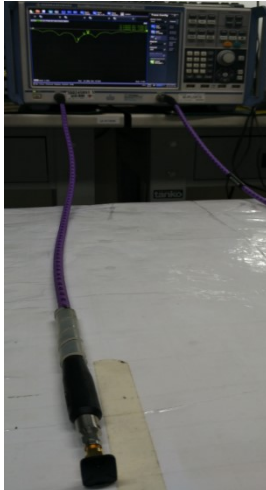

a) In free space

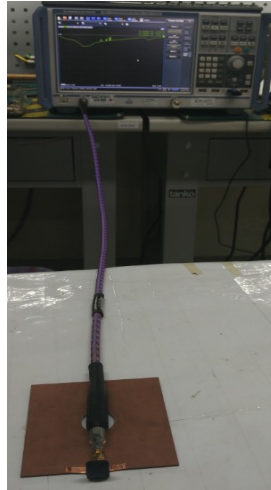

b) With 10*10cm
ground plane center

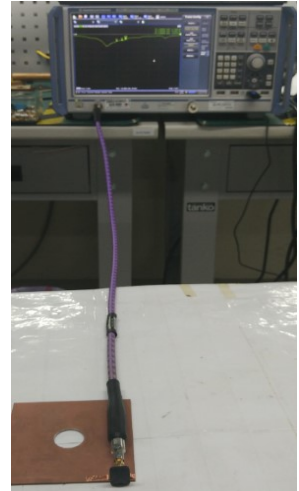

c) With 10*10cm
ground plane edge

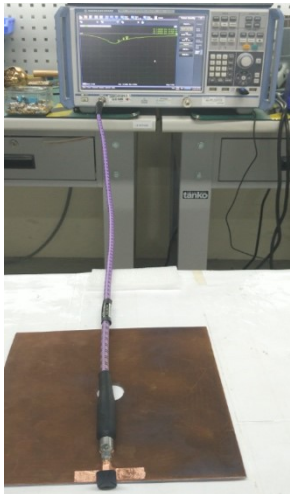

d) With 20*20cm
ground plane center

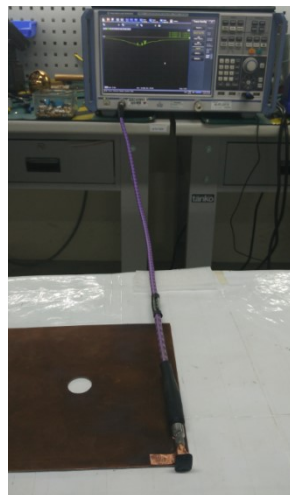

e) With 20*20cm
ground plane edge

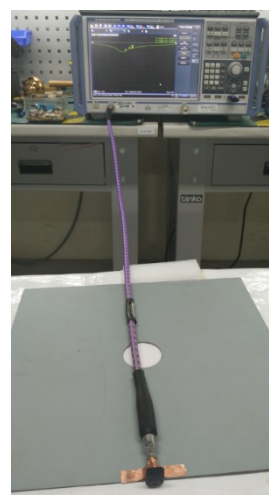

f) With 30*30cm
ground plane center

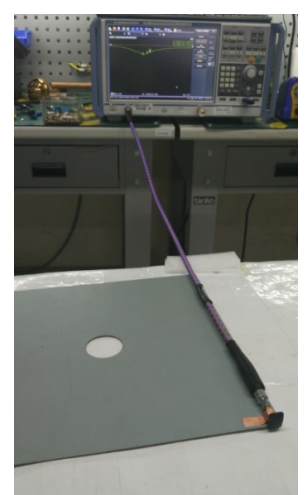

g) With 30*30cm
ground plane edge

Figure.1 Antenna Measurement Setup

3.2 Return Loss (In free space)

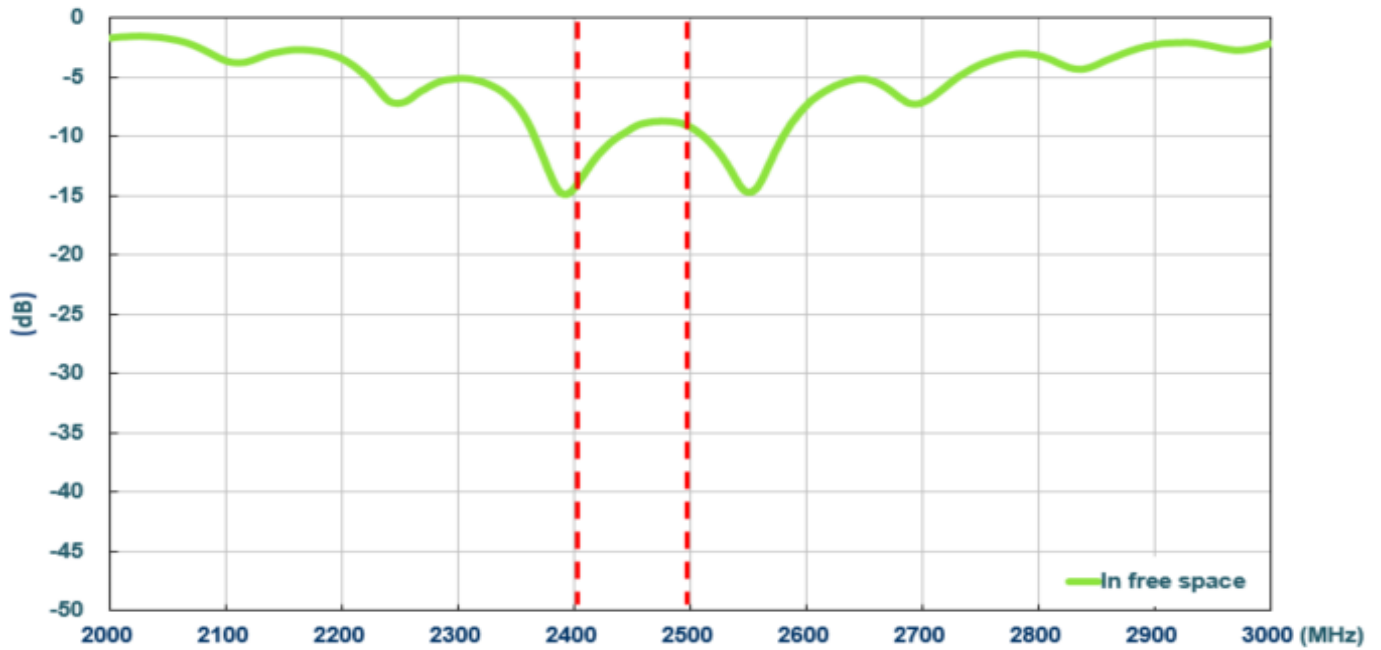

Figure 2. Return loss of WCM.01 antenna

3.3 Return Loss(On the ground plane Center)

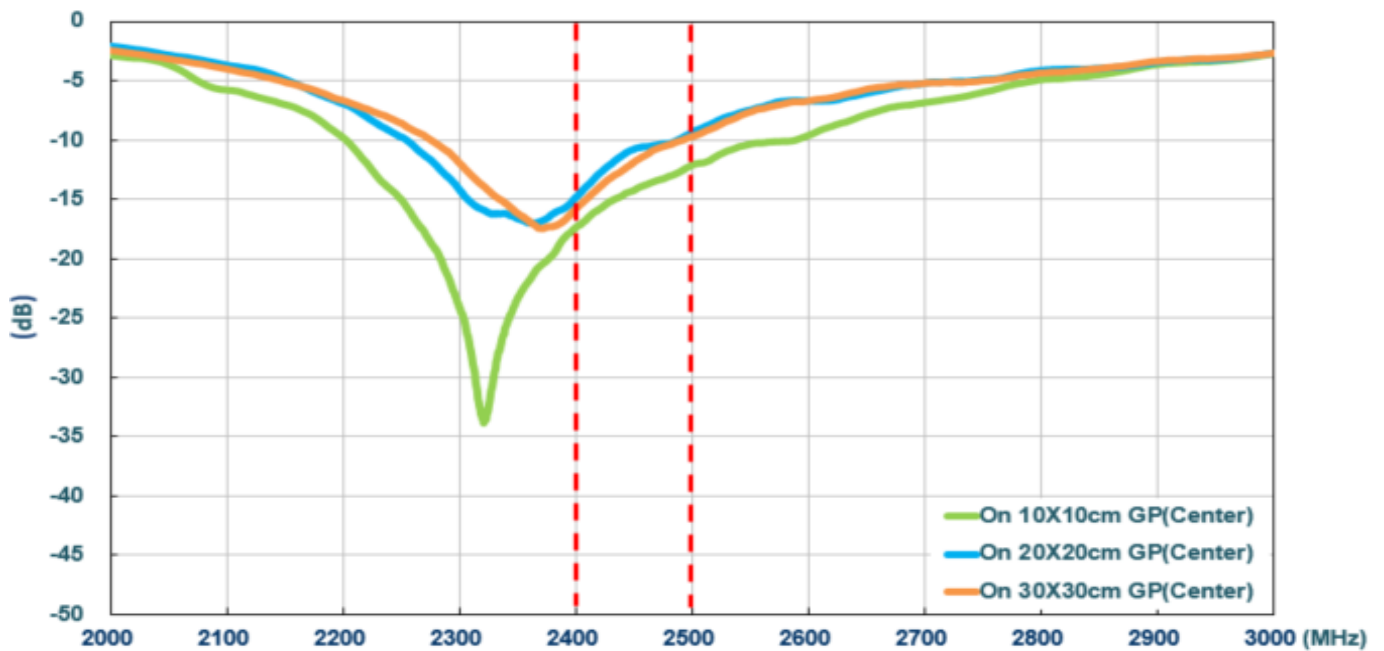

Figure 3. Return loss of WCM.01 antenna with different ground plane size

3.4 Return Loss (On the ground plane Edge)

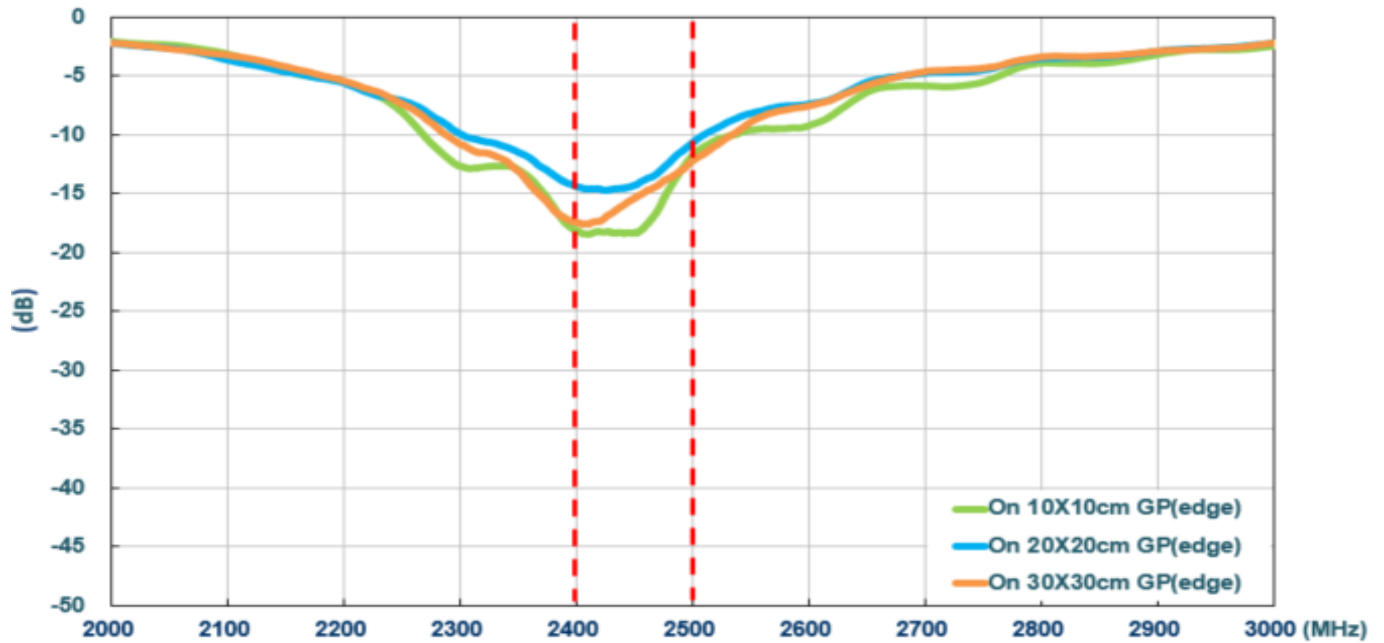

Figure 4. Return loss of WCM.01 antenna with different ground plane size

3.5 Efficiency (In free space)

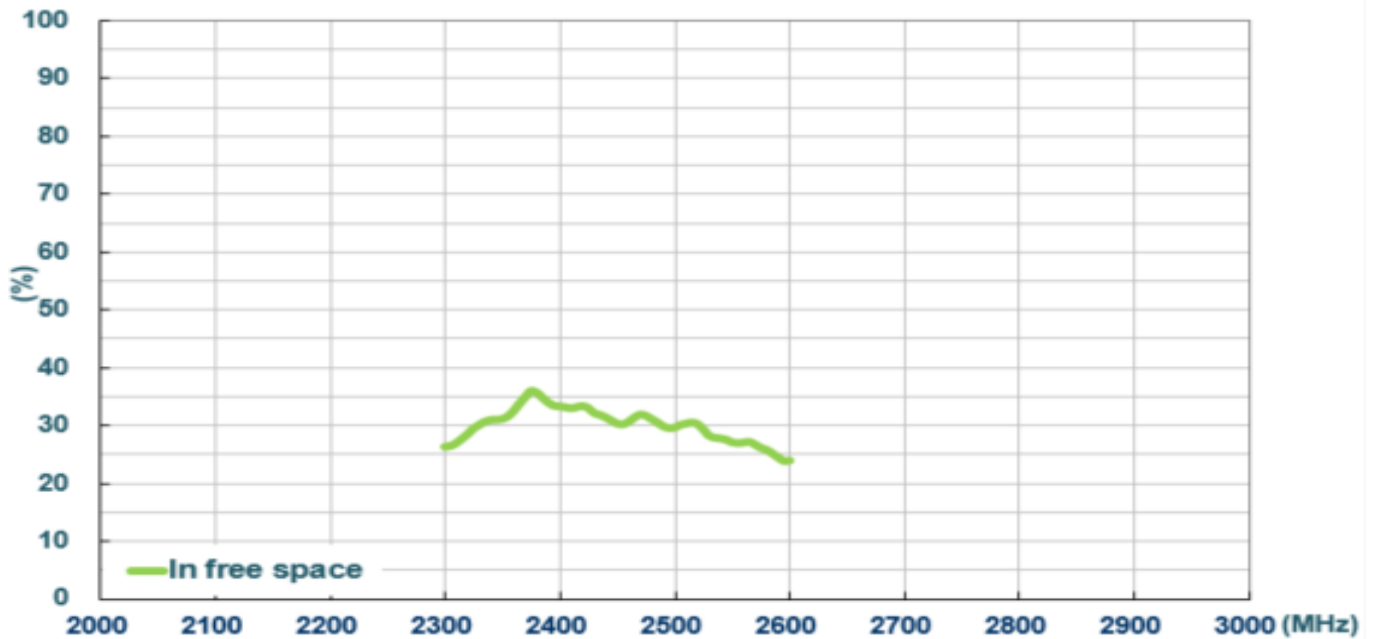

Figure 5. Efficiency of WCM.01 antenna

3.6 Efficiency (On the ground plane Center)

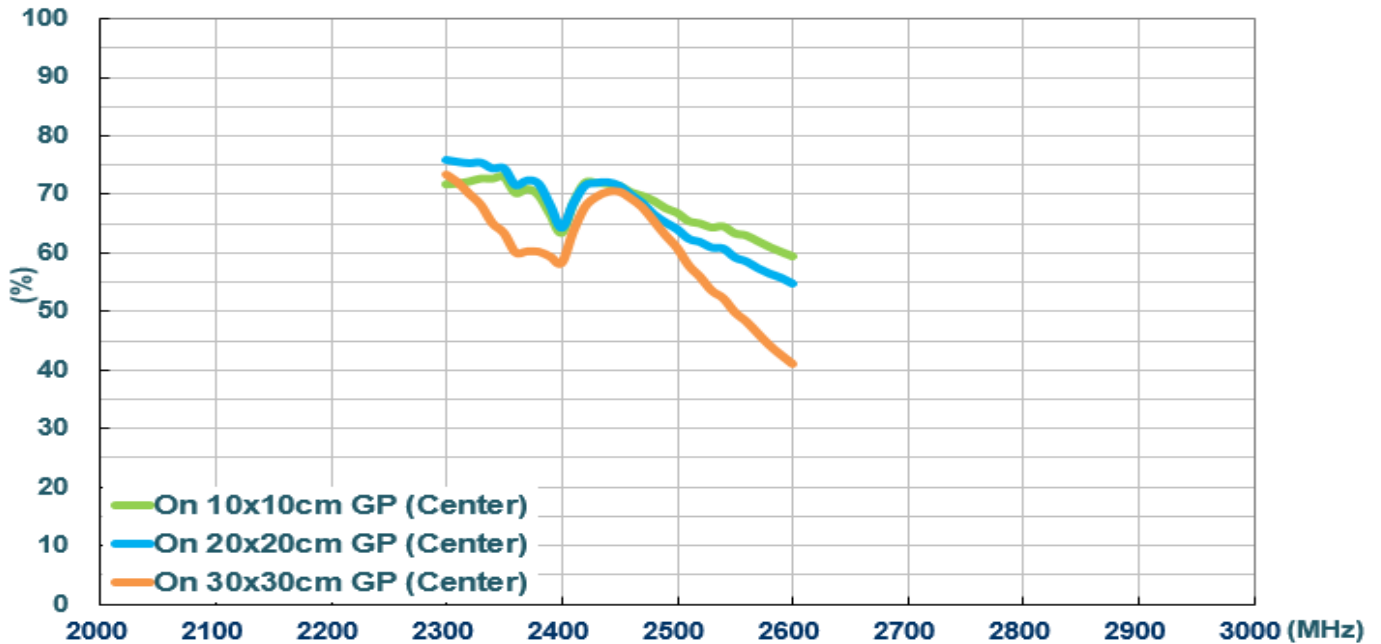

Figure 6. Return loss of WCM.01 antenna with different ground plane size

3.7 Efficiency (On the ground plane Edge)

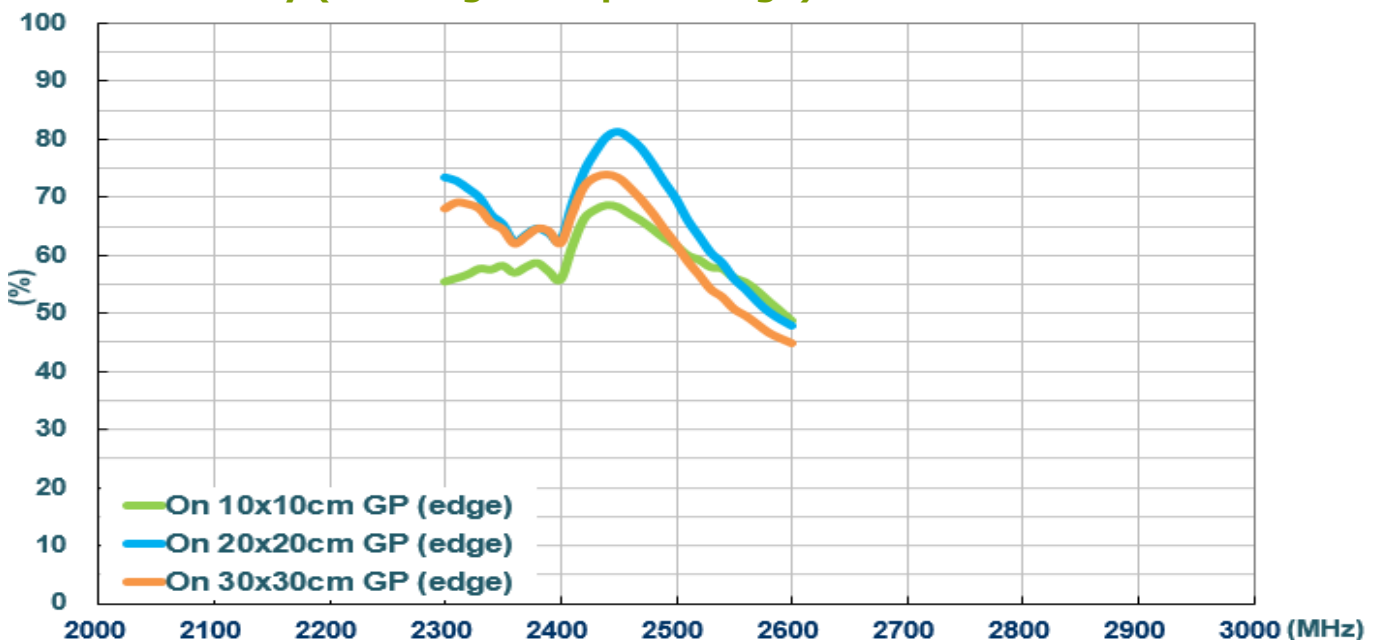

Figure 7. Return loss of WCM.01 antenna with different ground plane size

3.8 Peak Gain (In free space)

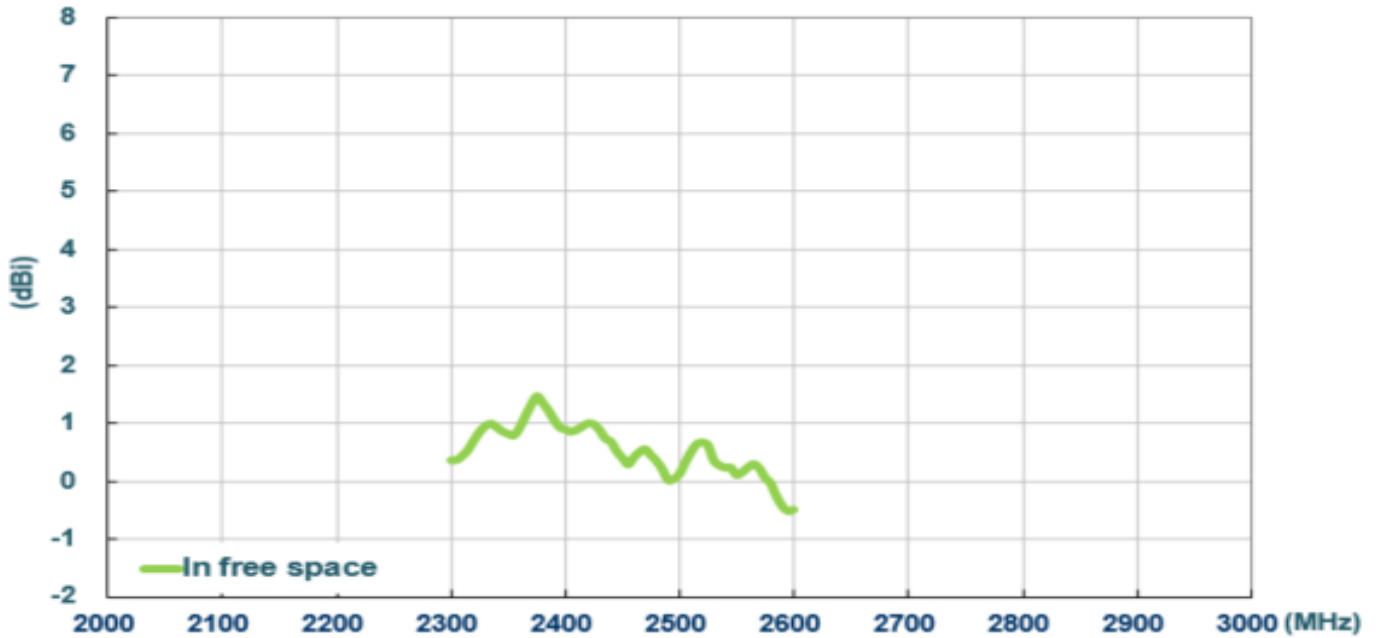

Figure 8. Peak gain of WCM.01 antenna with different ground plane size

3.9 Peak Gain (On the ground plane Center)

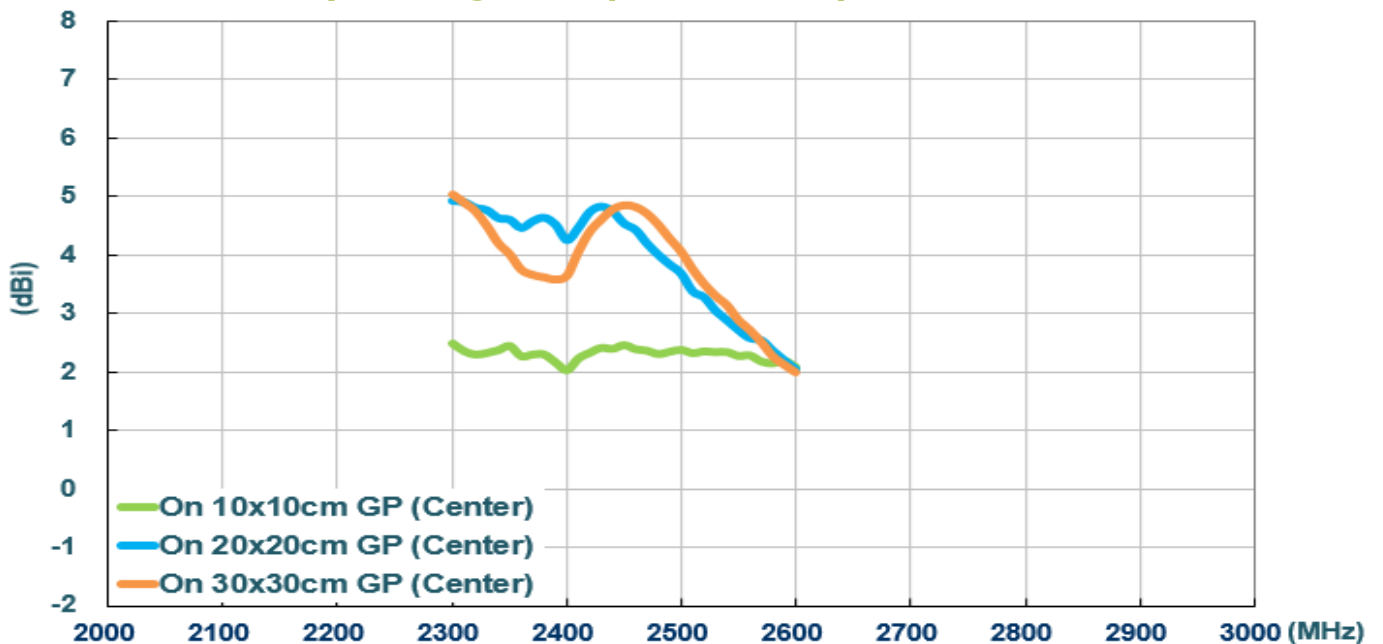

Figure 9. Peak gain of WCM.01 antenna with different ground plane size

3.10 Peak Gain (On the ground plane Edge)

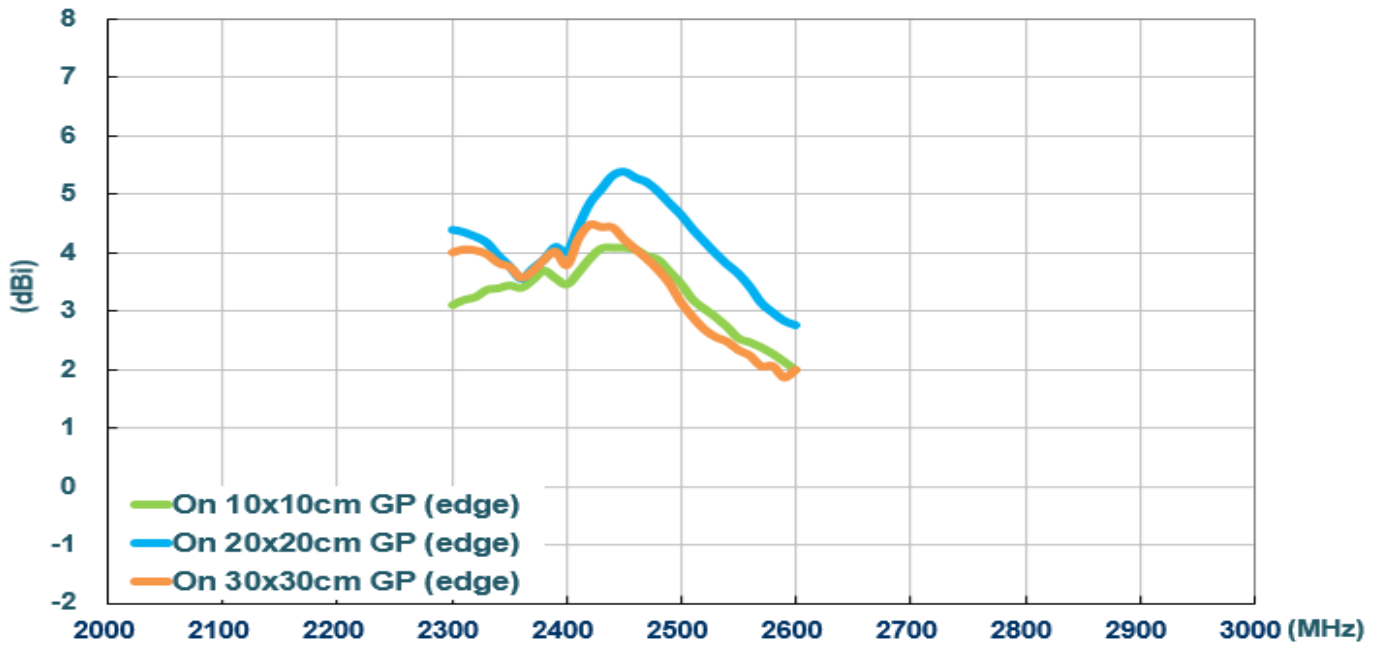

Figure 10. Peak gain of WCM.01 antenna with different ground plane size

3.11 Average Gain (In free space)

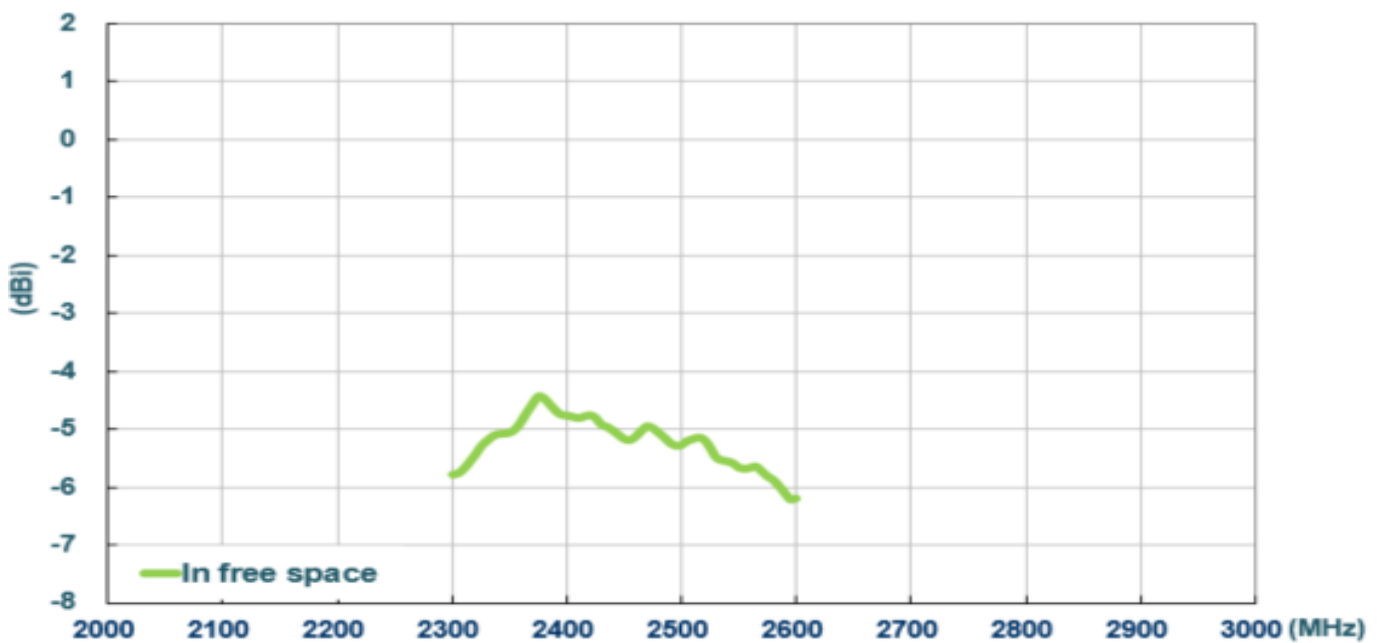

Figure 11. Average gain of WCM.01

3.12 Average Gain (On the ground plane Center)

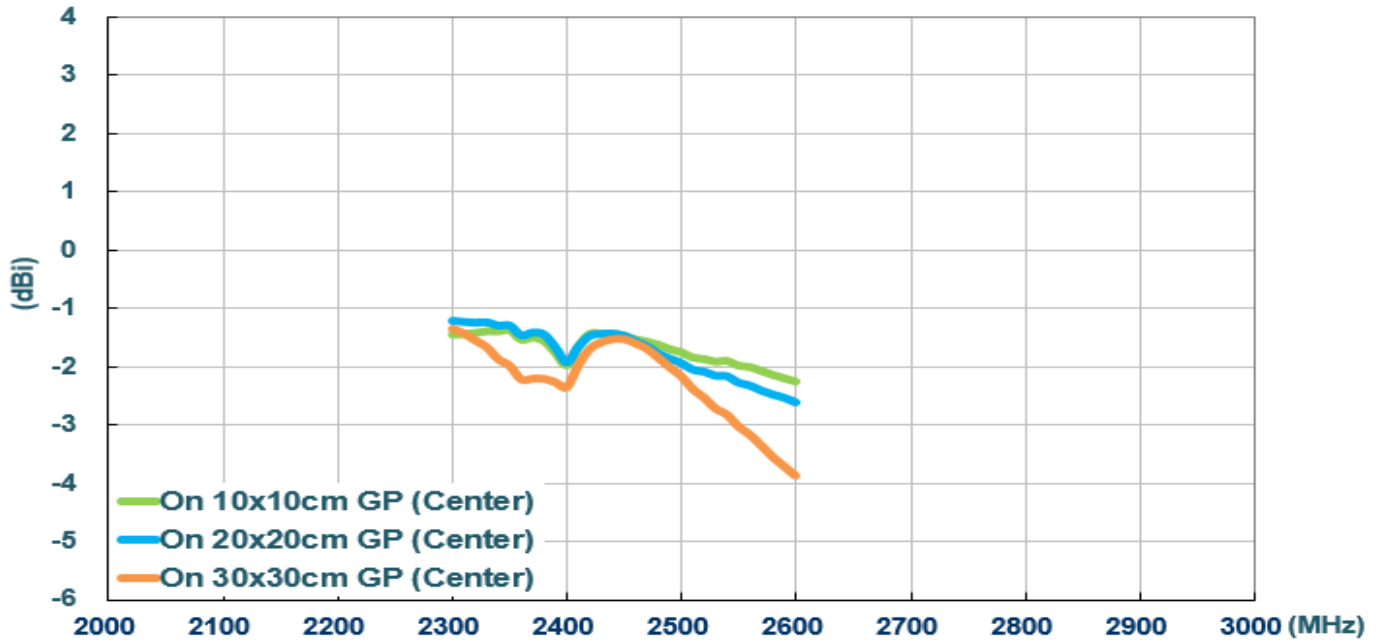

Figure 12. Average gain of WCM.01 antenna with different ground plane size

3.13 Average Gain (On the ground plane Edge)

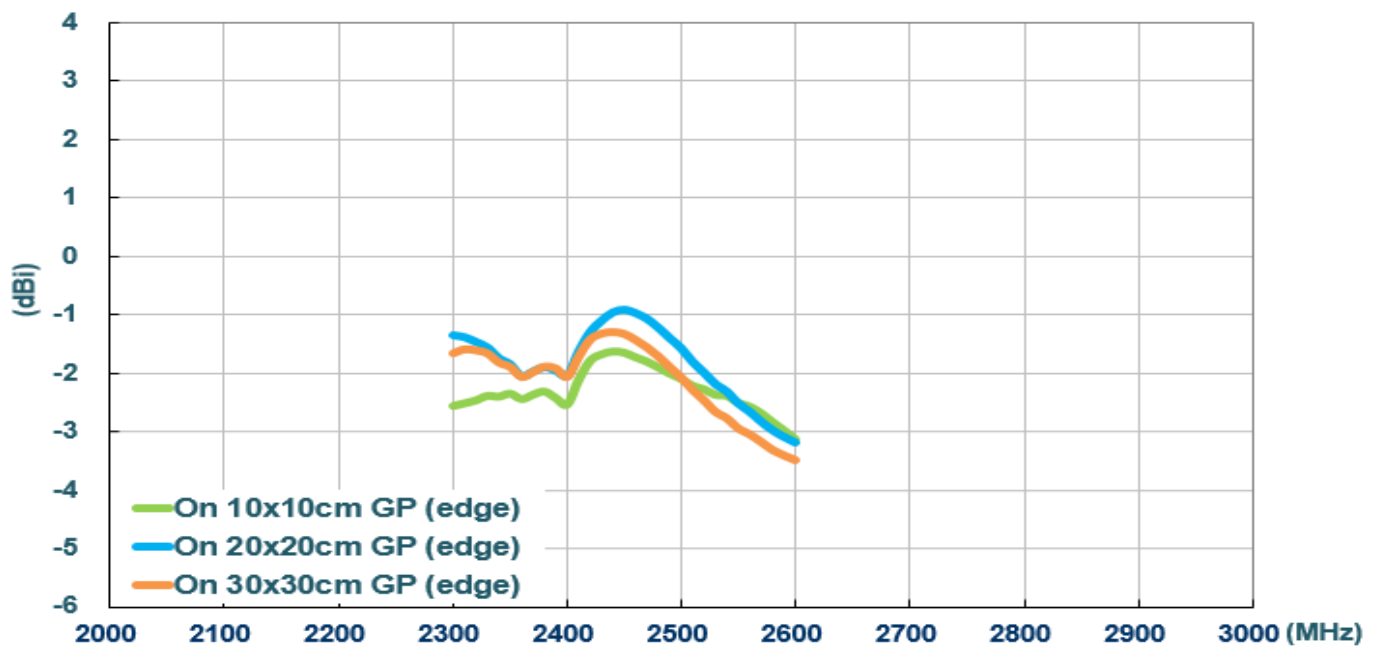

Figure 13. Average gain of WCM.01 antenna with different ground plane size

4. Antenna Radiation Patterns

The antenna radiation patterns were measured in CTIA certified ETS Anechoic Chamber. The measurement setup as below,



In Free Space

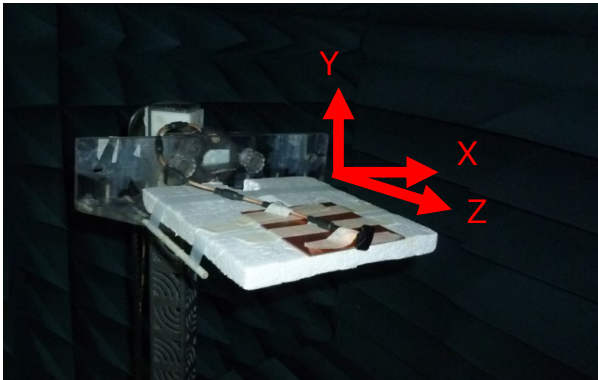

On 10*10cm ground plane (Center)

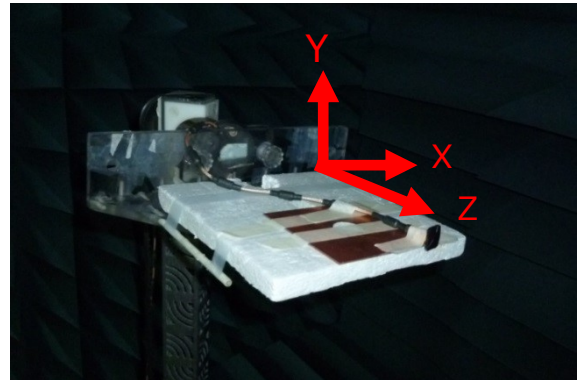

On 10*10cm ground plane (Edge)

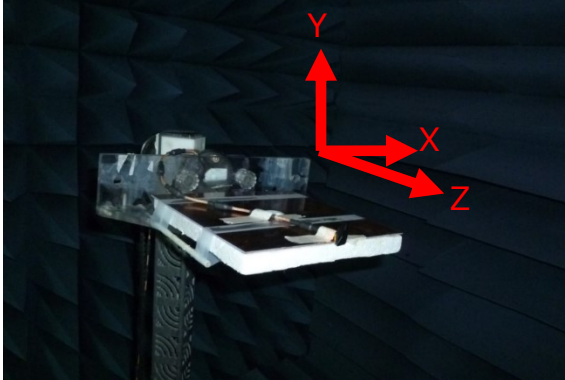

On 20*20cm ground plane (Center)

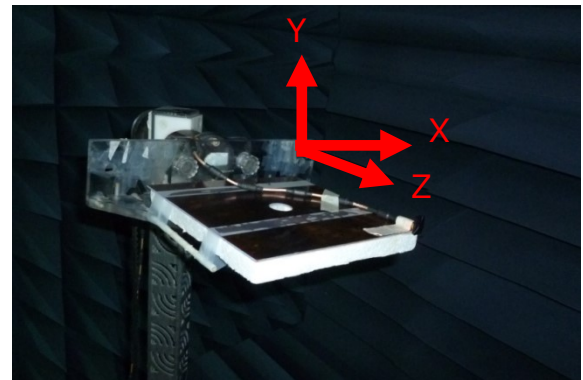

On 20*20cm ground plane (Edge)

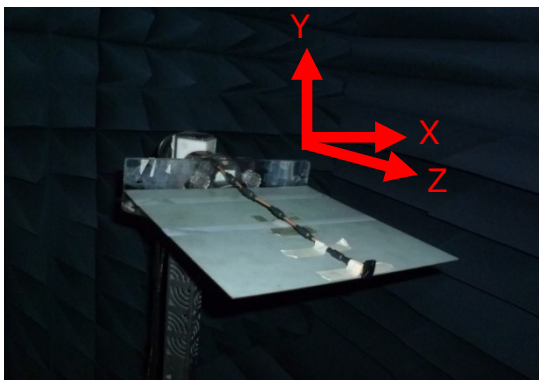

On 30*30cm ground plane (Center)

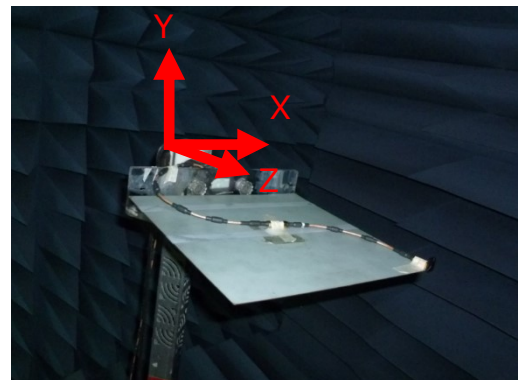

On 30*30cm ground plane (Edge)

Figure.14. Testing Setup in ETS Anechoic Chamber

4.1 2D Radiation Pattern (In free space)
XY Plane

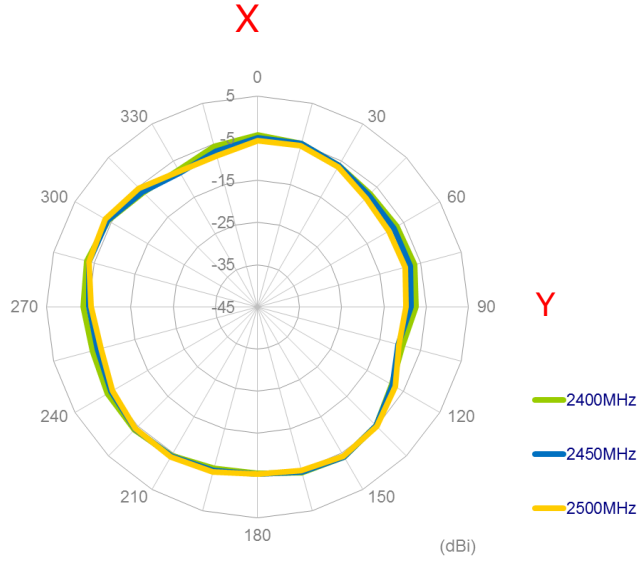

XZ Plane

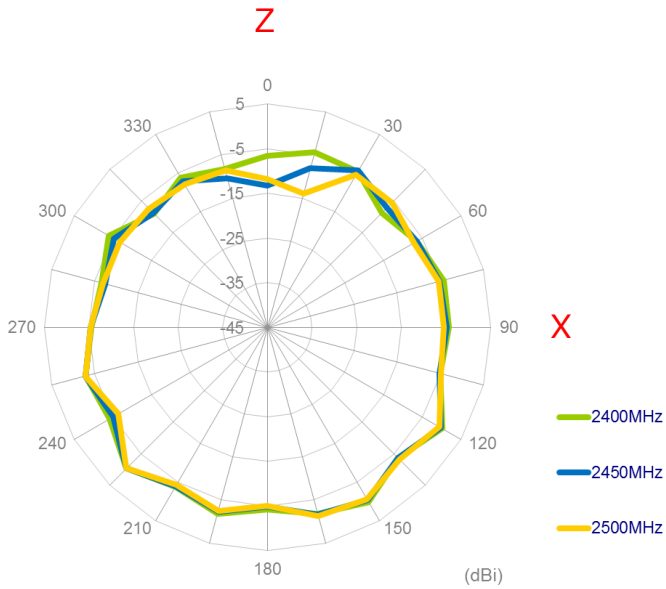

YZ Plane

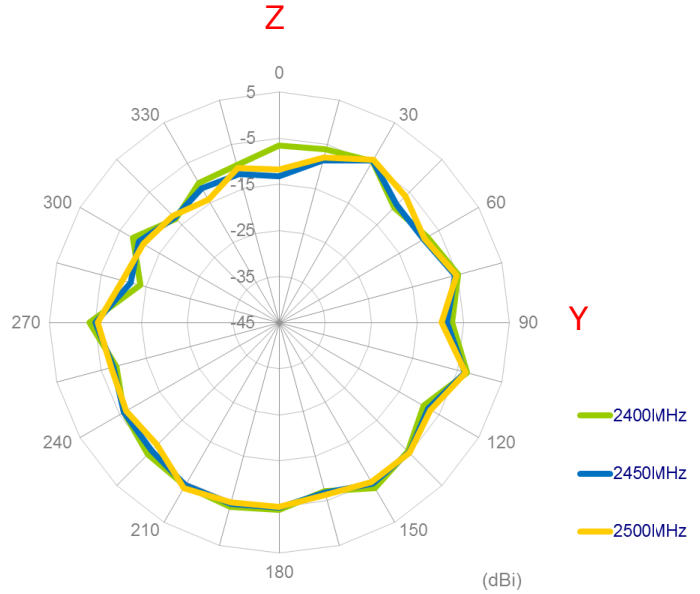

4.2 3D Radiation Pattern (In free space)

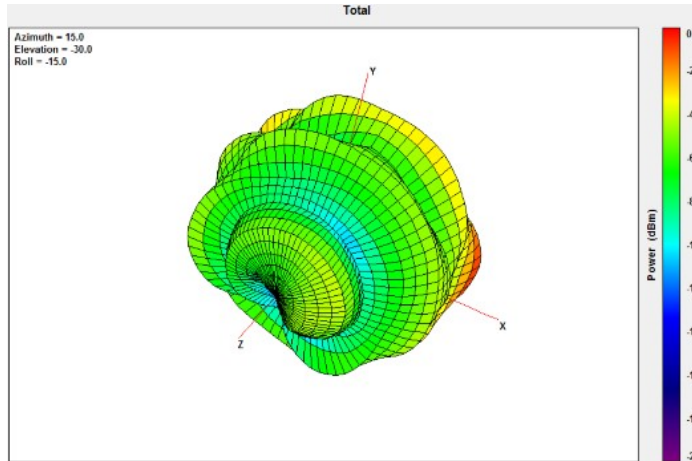

2400MHz

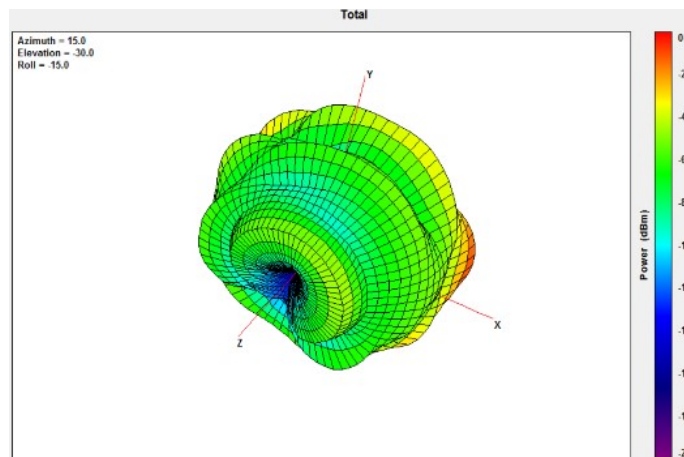

2450MHz

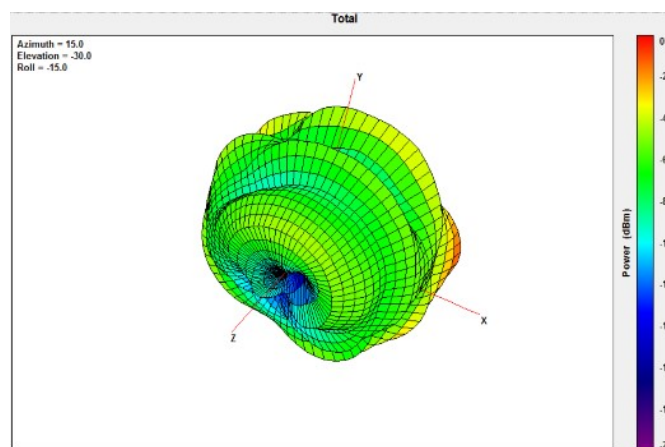

2500MHz

4.3 2D Radiation Pattern (On the 10*10cm ground plane Center)

XY Plane

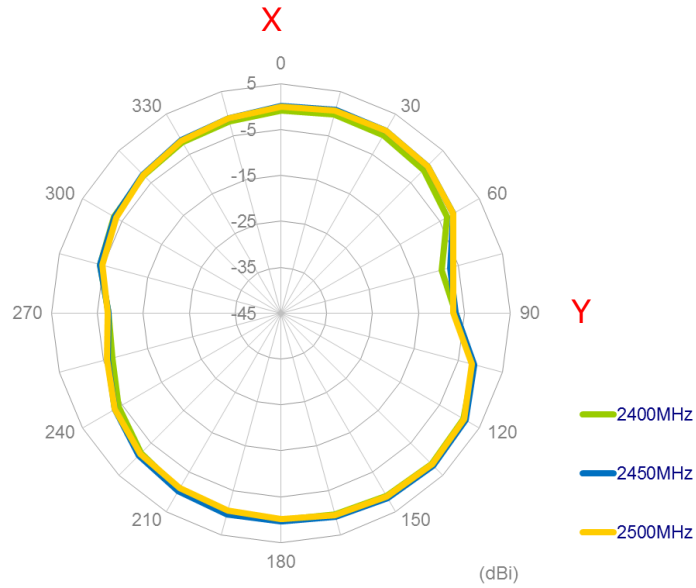

XZ Plane

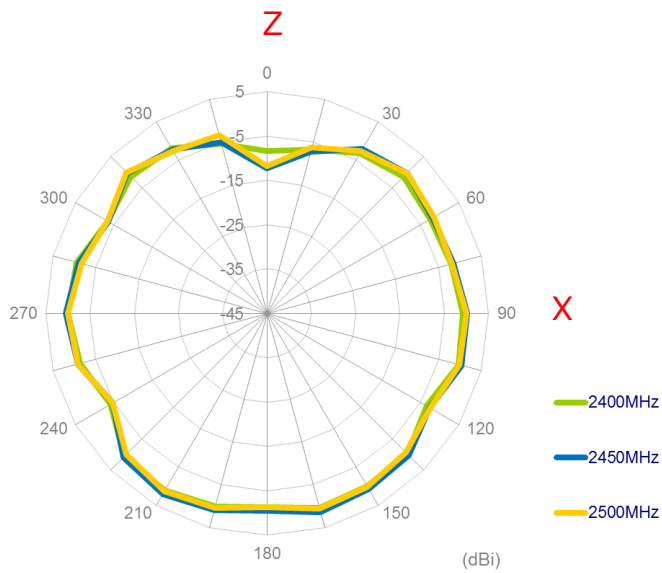

YZ Plane

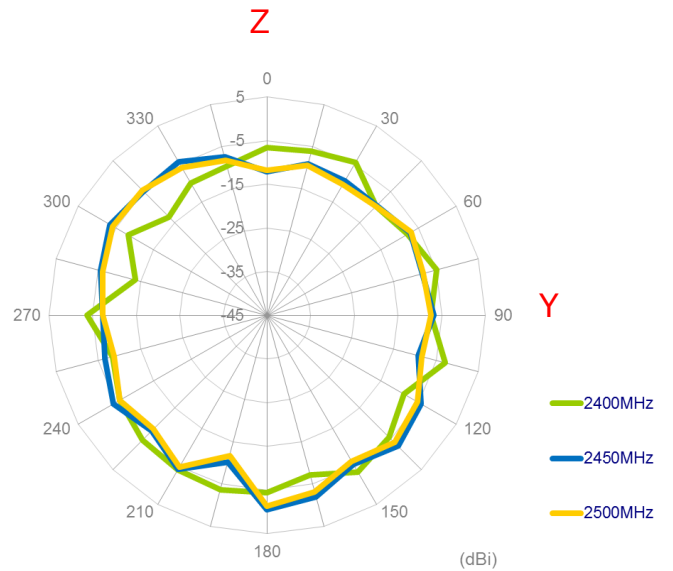

4.4 3D Radiation Pattern (On the 10*10cm ground plane Center)

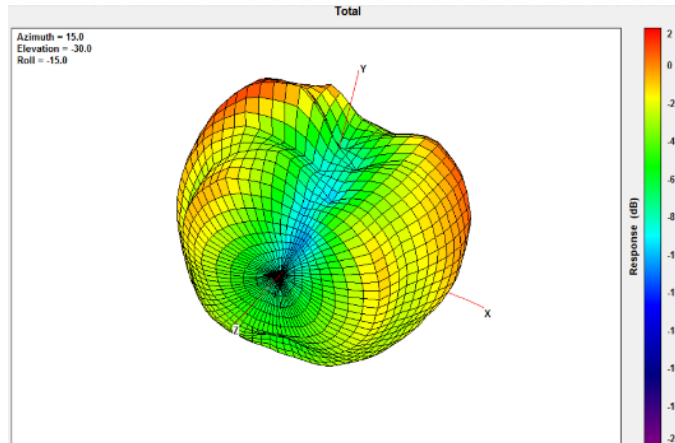

2400MHz

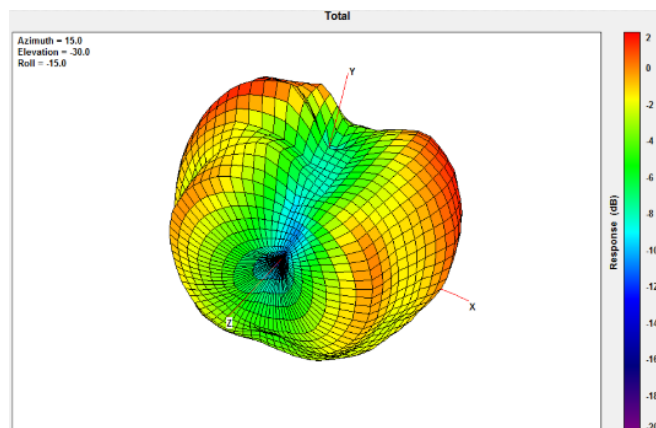

2450MHz

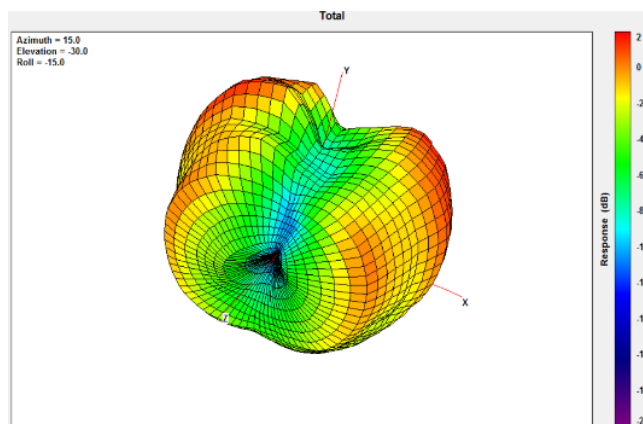

2500MHz

4.5 2D Radiation Pattern (On the 10*10cm ground plane Edge)

XY Plane

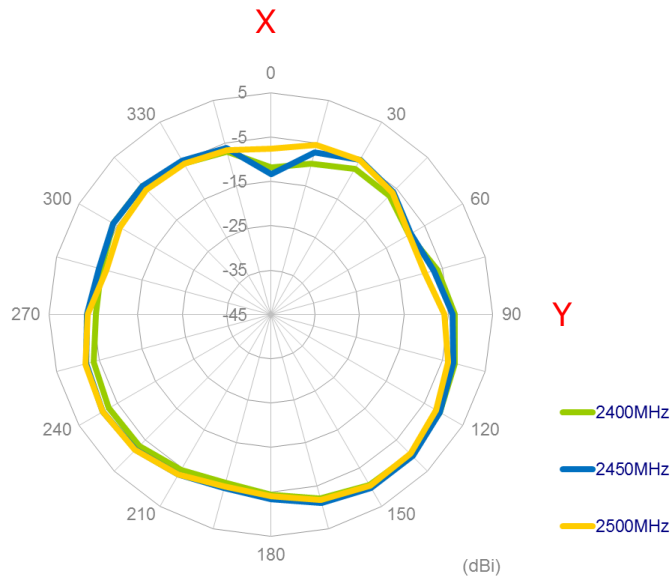

XZ Plane

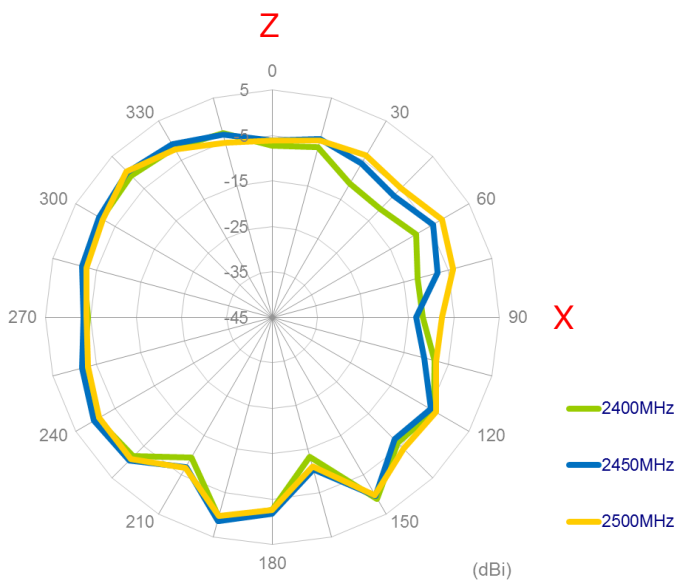

YZ Plane

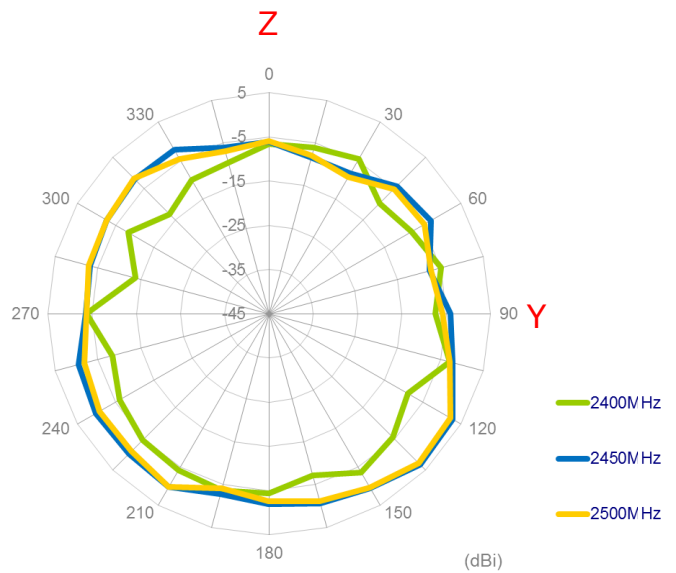

4.6 3D Radiation Pattern (On the 10*10cm ground plane Edge)

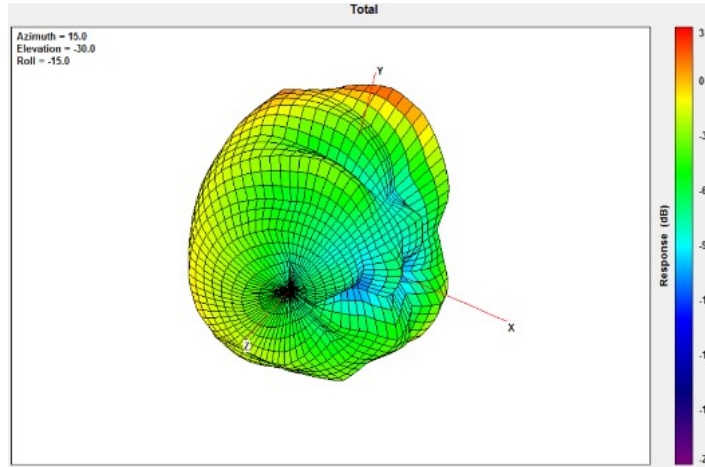

2400MHz

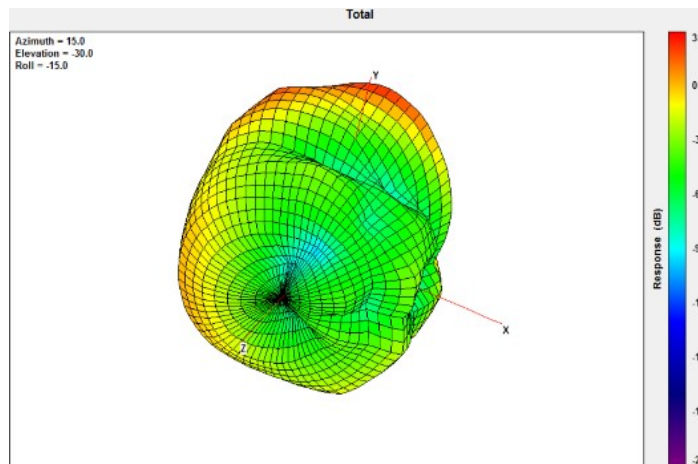

2450MHz

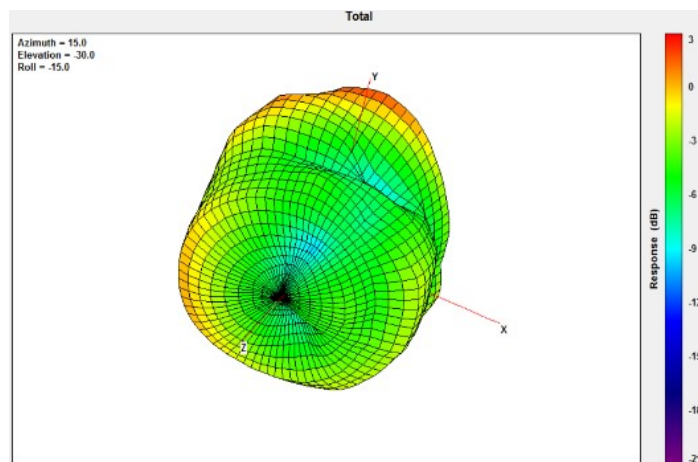

2500MHz

4.7 2D Radiation Pattern (On the 20*20cm ground plane Center)

XY Plane

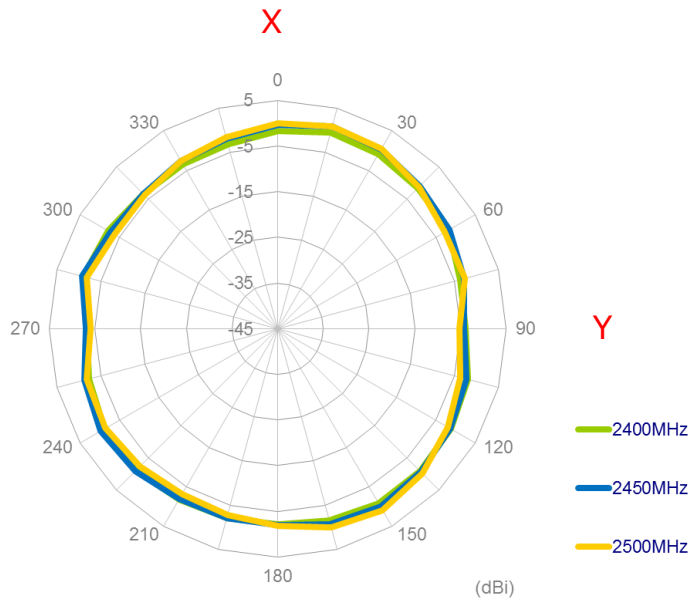

XZ Plane

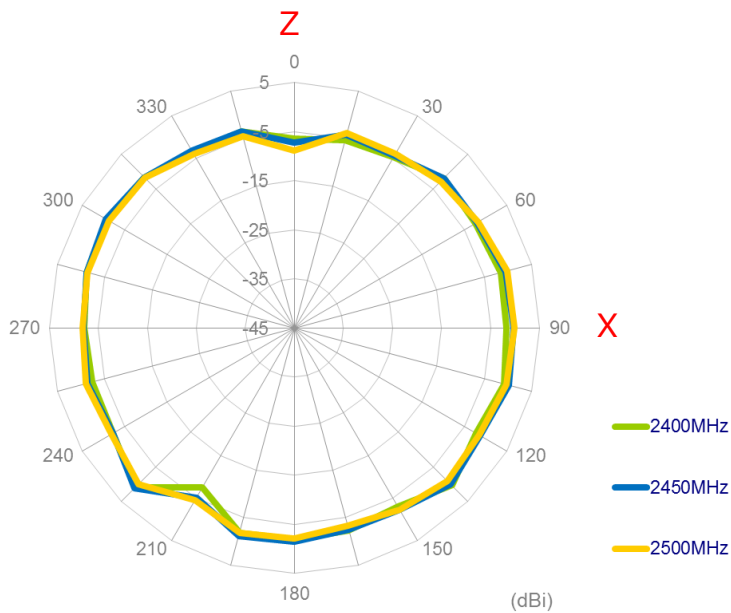

YZ Plane

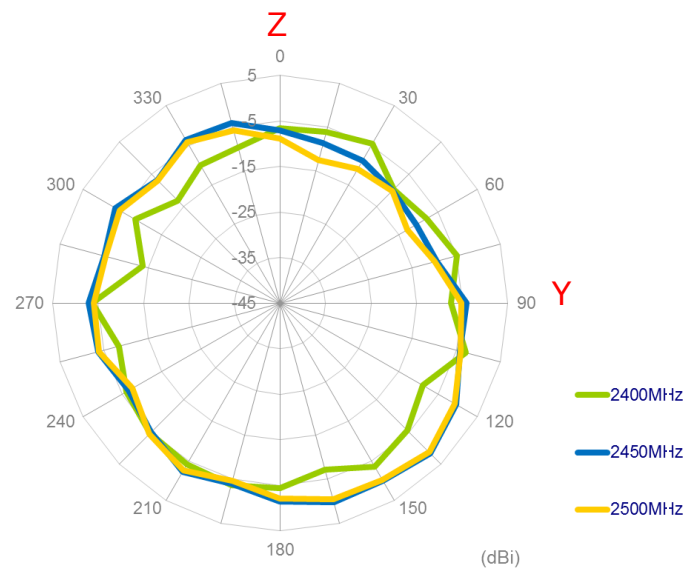

4.8 3D Radiation Pattern (On the 20*20cm ground plane Center)

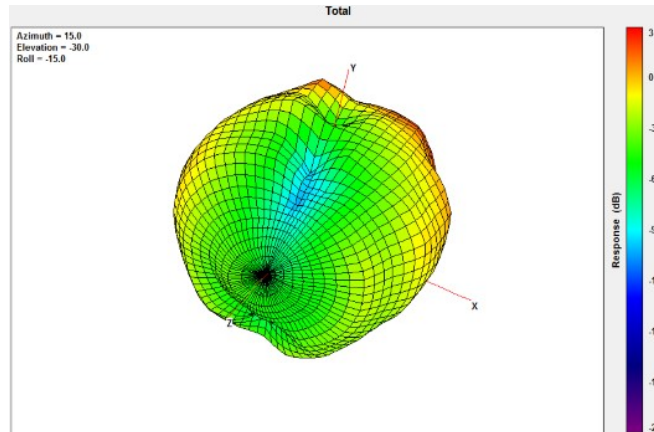

2400MHz

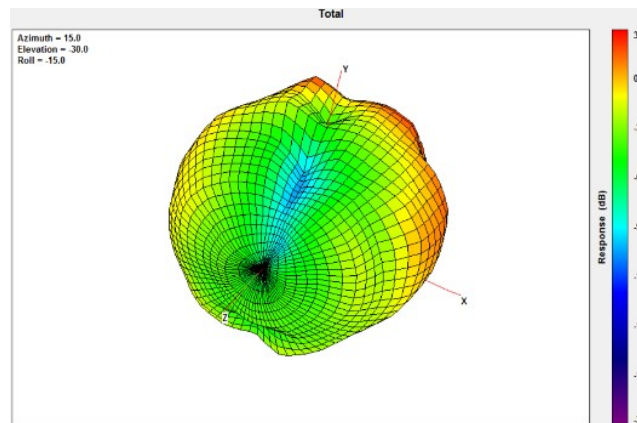

2450MHz

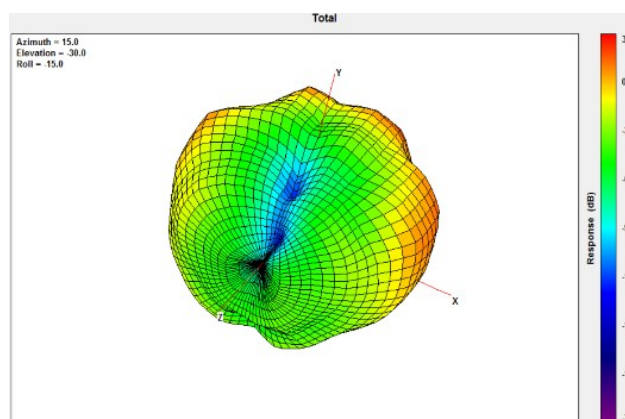

2500MHz

4.9 2D Radiation Pattern (On the 20*20cm ground plane Edge)

XY Plane

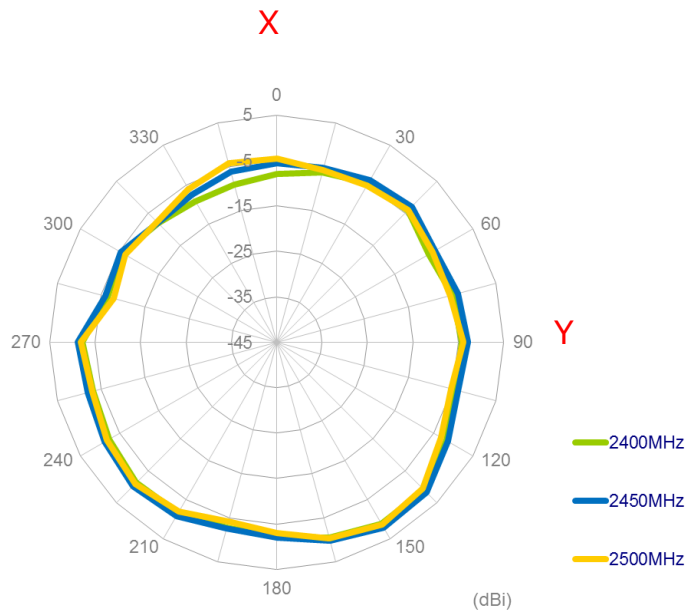

XZ Plane

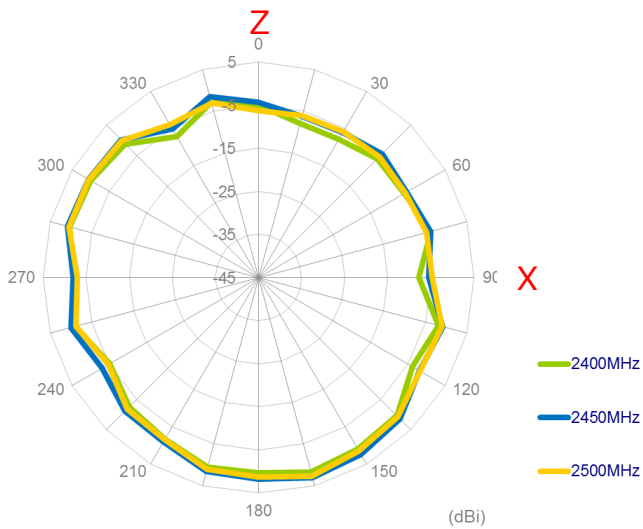

YZ Plane

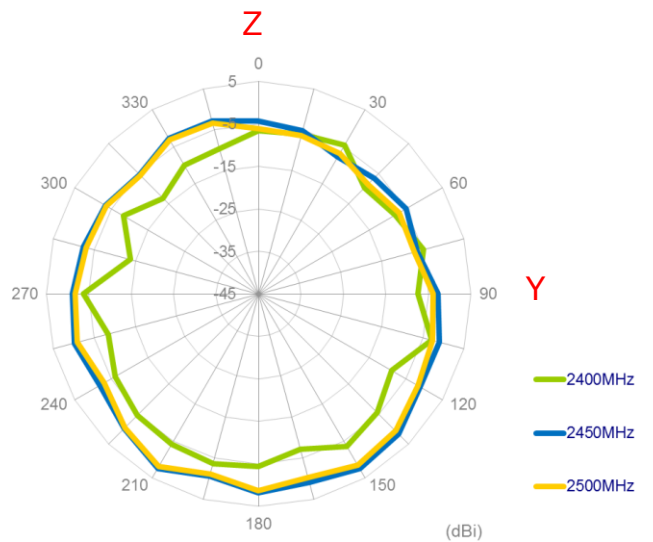

4.10 3D Radiation Pattern (On the 20*20cm ground plane Edge)

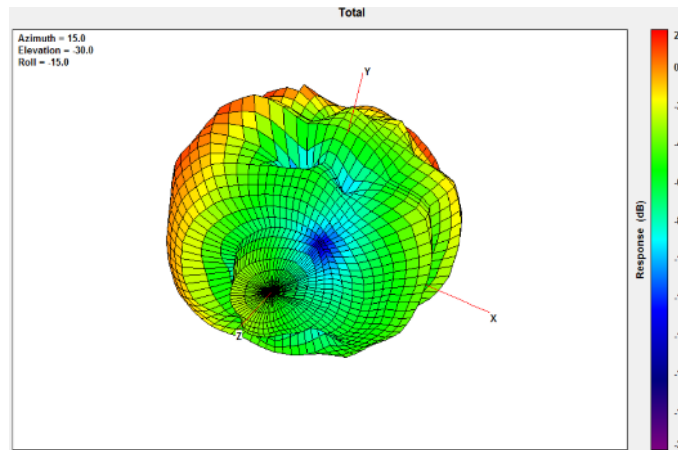

2400MHz

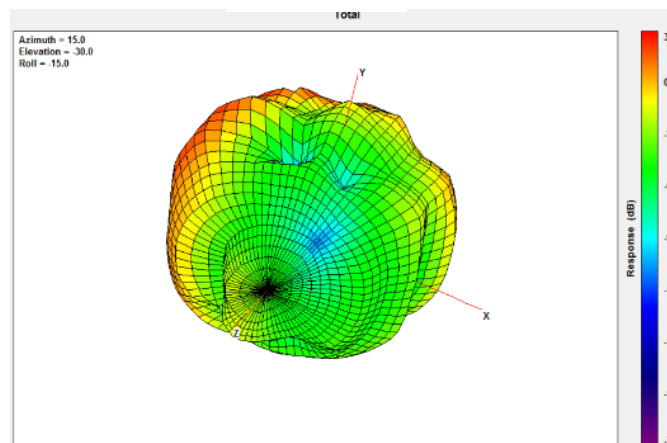

2450MHz

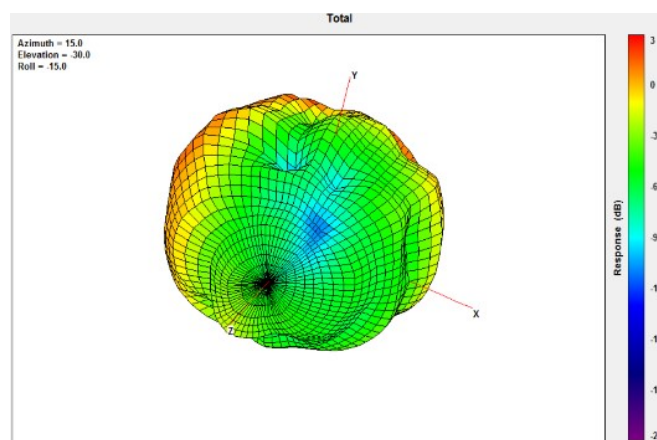

2500MHz

4.11 2D Radiation Pattern (On the 30*30cm ground plane Center)

XY Plane

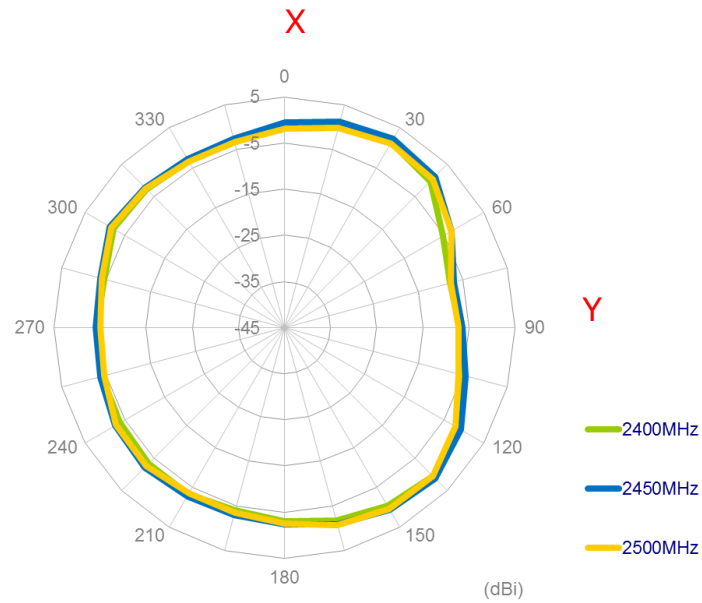

XZ Plane

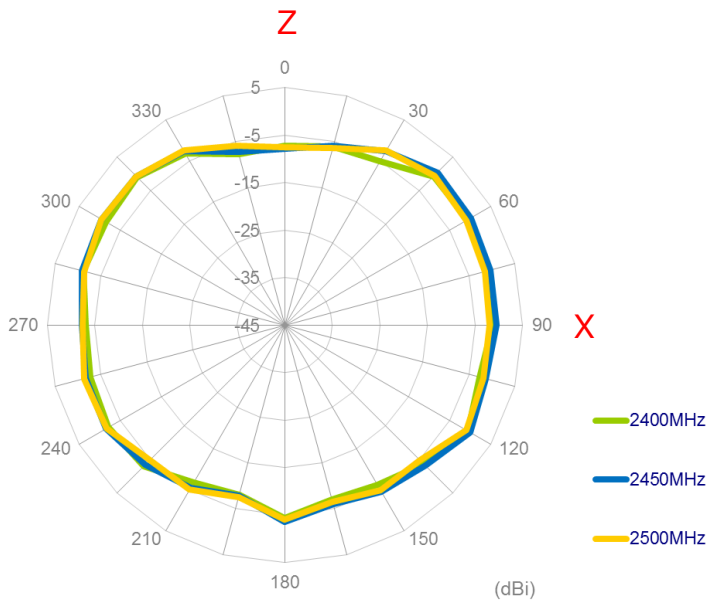

YZ Plane

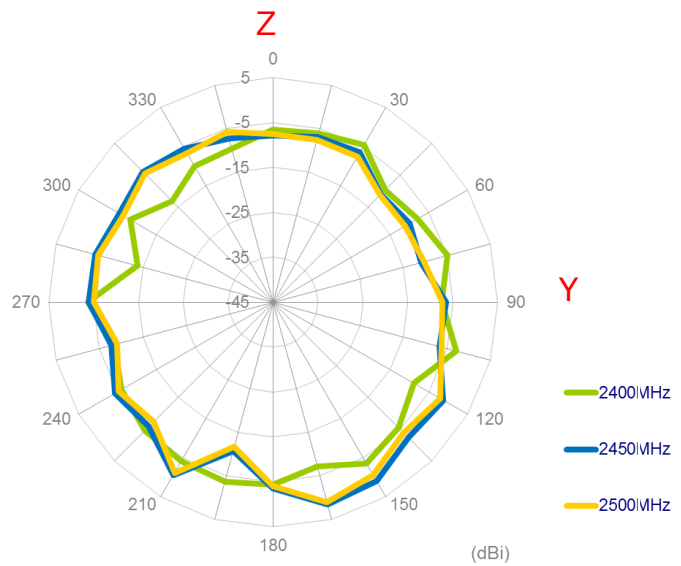

4.12 3D Radiation Pattern (On the 30*30cm ground plane Center)

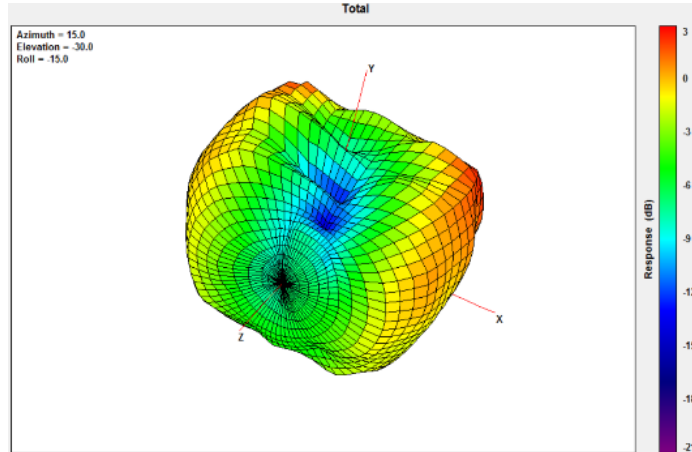

2400MHz

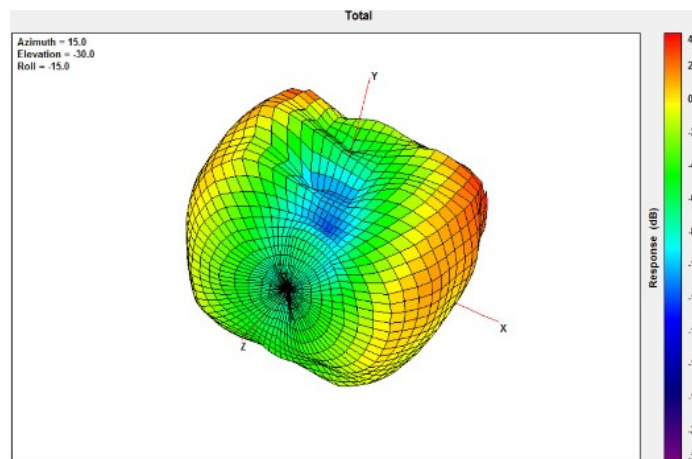

2450MHz

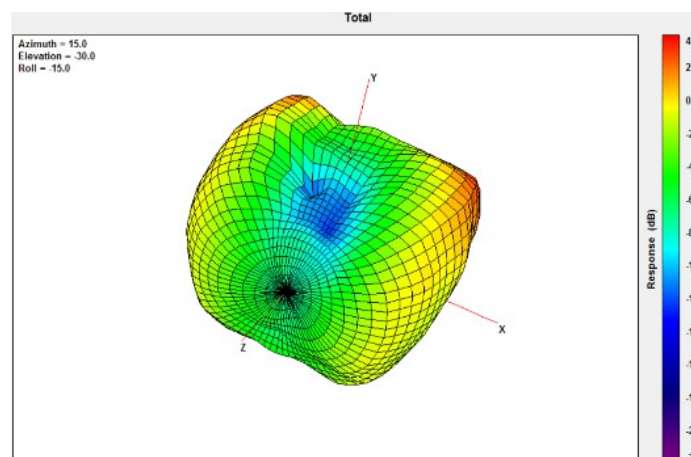

2500MHz

4.13 2D Radiation Pattern (On the 30*30cm ground plane Edge)

XY Plane

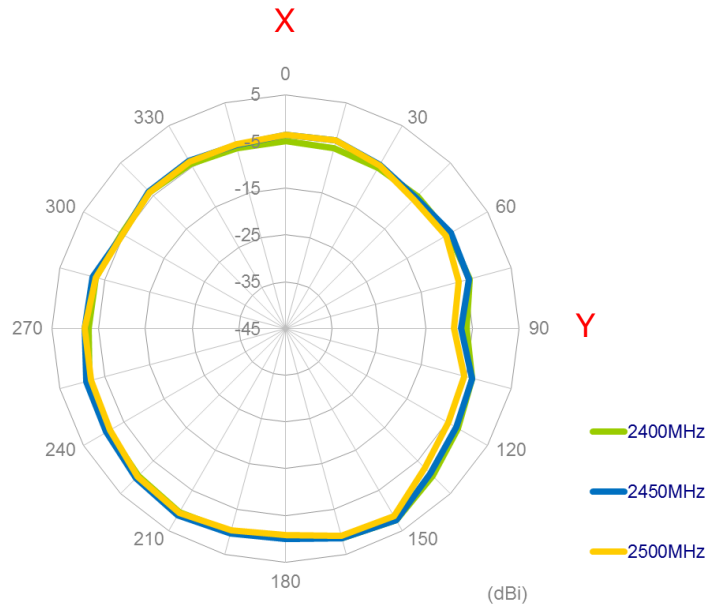

XZ Plane

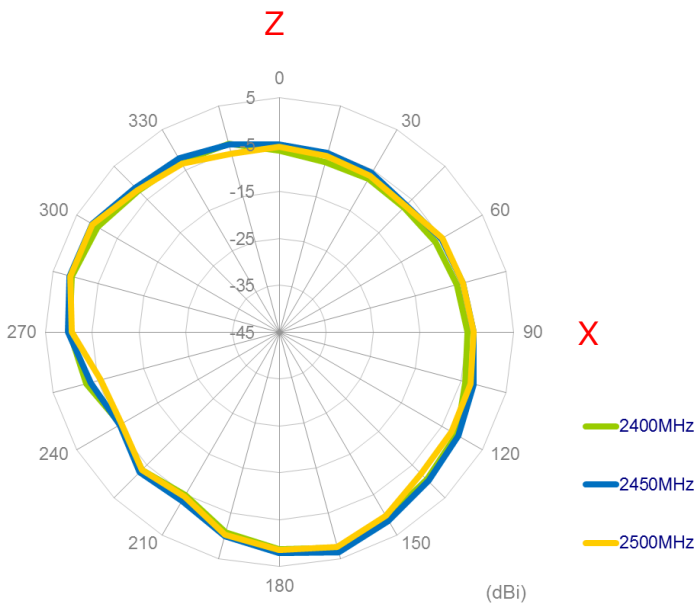

YZ Plane

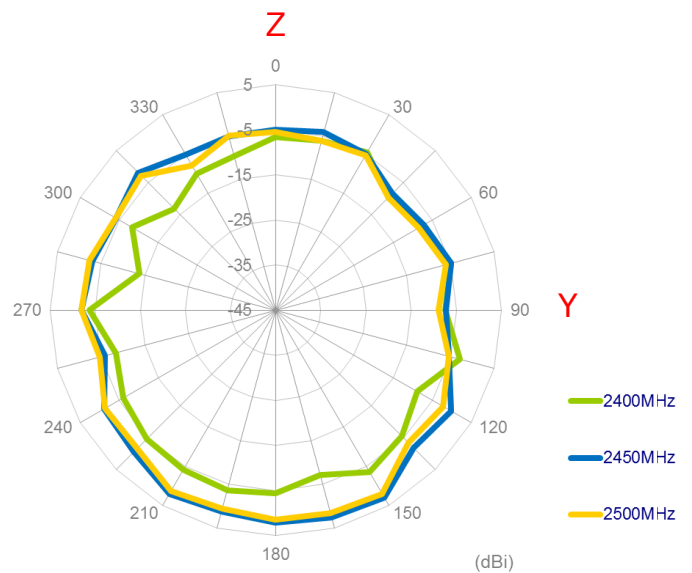

4.14 3D Radiation Pattern (On the 30*30cm ground plane Edge)

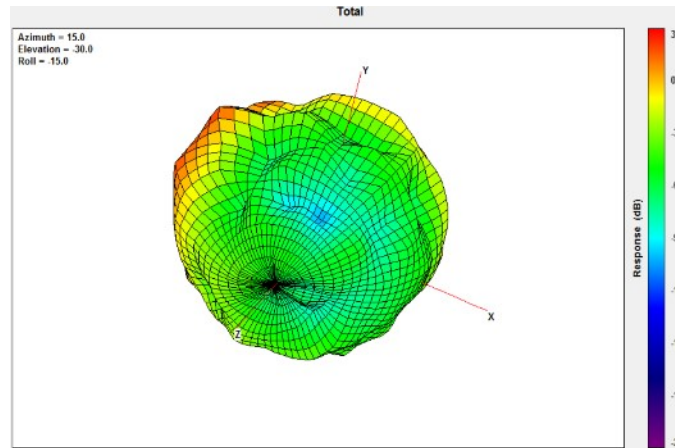

2400MHz

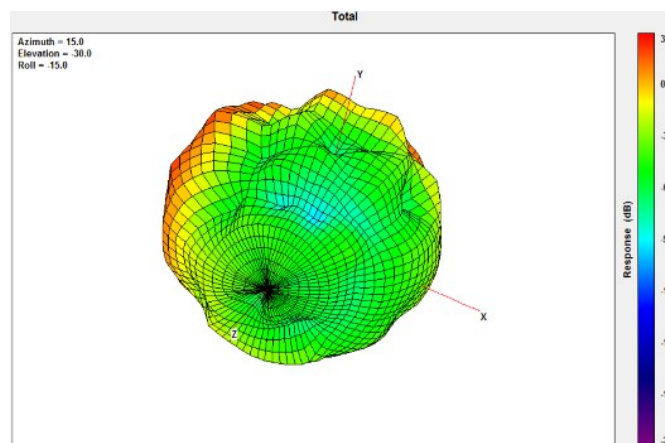

2450MHz

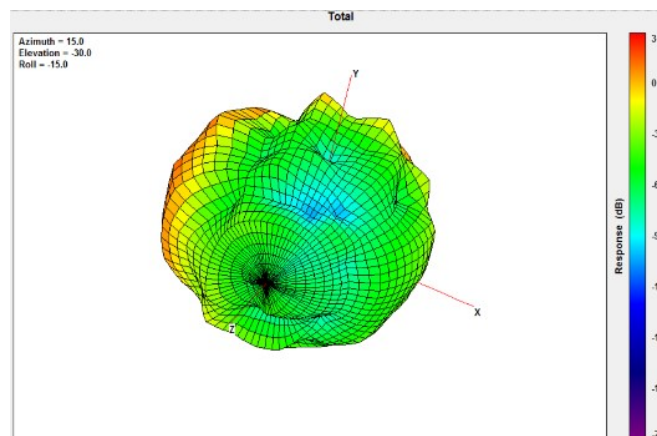

2500MHz

5. Drawing (Unit: mm)



3D View

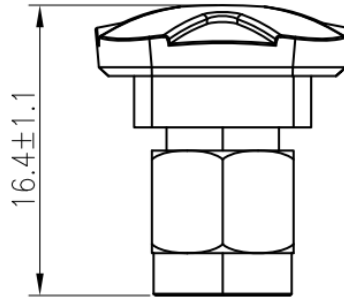

Top View

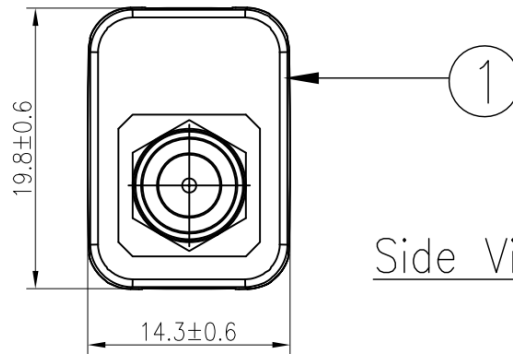

Side View

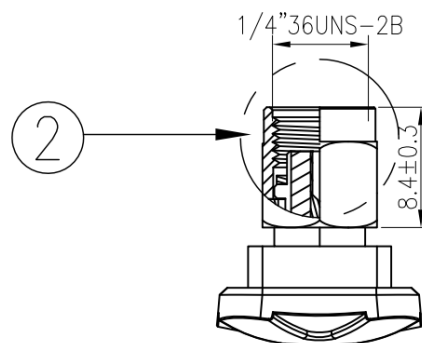

Bottom View

	Name	Material	Finish	QTY
1	External housing	ABS	Black	1
2	RP-SMA(M)	Brass	Gold	1

6. Packaging

1 pcs WCM.01.0151 per PE Bag
 PE Bag Dimensions - 80*40mm
 Weight - .007g

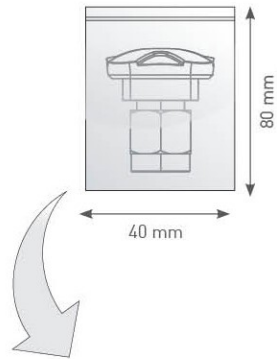

100 PE Bags per Large PE Bag
 100 pcs WCM.01.0151 per Large PE Bag
 Large Polybag Dimensions - 240*170mm
 Weight - 0.7kg

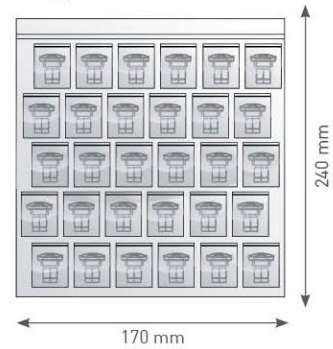

15 Large PE bags per carton
 1500 pcs WCM.01.0151 per carton
 Carton Dimensions - 360*310*160mm
 Weight - 11kg

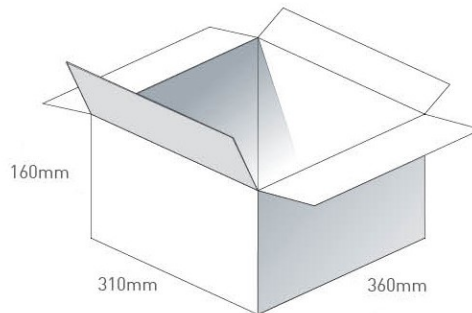

Pallet Dimensions 1080mm*930m*1430mm
 72 Cartons per Pallet
 12 Cartons per layer
 6 Layers

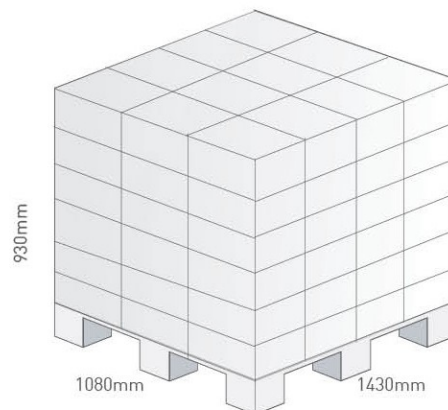

Taoglas makes no warranties based on the accuracy or completeness of the contents of this document and reserves the right to make changes to specifications and product descriptions at any time without notice. Taoglas reserves all rights to this document and the information contained herein.

Reproduction, use or disclosure to third parties without express permission is strictly prohibited.

Copyright © Taoglas Ltd.